

## EMC filter surge protection device - SFP 1-5/120AC - 2920667

Please be informed that the data shown in this PDF Document is generated from our Online Catalog. Please find the complete data in the user's documentation. Our General Terms of Use for Downloads are valid (<http://phoenixcontact.com/download>)



Device protection, according to type 3/class III, with network interference suppression filter to prevent high-frequency interference voltages, for 1-phase power supply networks with separate N and PE (3-conductor system: L1, N, PE), with remote indication contact.

### Product Description

Device protection with interference filter

### Your advantages

- ✓ Can be installed in industrial environments
- ✓ Combined protective circuit for absorbing transient surge voltages and high-frequency interference voltages
- ✓ Thermal monitoring of the protective circuit
- ✓ Disconnection status signaled via floating remote indication contact
- ✓ Integrated power display switches off automatically when there is a malfunction due to overload.



### Key Commercial Data

Packing unit	1 pc
GTIN	 4 046356 158558
GTIN	4046356158558
Weight per Piece (excluding packing)	571.280 g
Custom tariff number	85363010
Country of origin	Germany

### Technical data

#### Dimensions

Height	86.6 mm
Width	112 mm
Depth	79 mm

#### Ambient conditions

Degree of protection	IP20
Ambient temperature (operation)	-25 °C ... 70 °C

# EMC filter surge protection device - SFP 1-5/120AC - 2920667

## Technical data

### Ambient conditions

Ambient temperature (storage/transport)	-25 °C ... 70 °C
Permissible humidity (operation)	5 % ... 95 %

### General

EN type	T3
Number of ports	Two
Mode of protection	L-N
	L-PE
	N-PE
Mounting type	DIN rail: 35 mm
Color	black
	silver
Housing material	Aluminum
Degree of pollution	2
Flammability rating according to UL 94	V-0
Type	DIN rail module, one-piece
Number of positions	2
Surge protection fault message	Optical, remote indicator contact
For country-specific use in	USA, CN, BR

### Protective circuit

Nominal voltage $U_N$	120 V AC (TN)
	120 V AC (TT - only in use with RCD)
	120 V AC (IT)
Nominal frequency $f_N$	50 Hz (60 Hz)
Maximum continuous voltage $U_C$	150 V AC
Rated load current $I_L$	5 A (70°C)
Residual current $I_{PE}$	≤ 0.6 mA
Nominal discharge current $I_n$ (8/20) $\mu$ s	3 kA
Standby power consumption $P_C$	≤ 7.5 VA (at $U_{REF}$ )
	≤ 10 VA (at $U_C$ )
Reference test voltage $U_{REF}$	132 V AC
Combination wave $U_{OC}$	6 kV (3 kA)
Voltage protection level $U_p$	≤ 0.45 kV
TOV behavior at $U_T$ (L-N)	175 V AC (5 s / withstand mode)
	240 V AC (5 s / safe failure mode)
	208 V AC (120 min / safe failure mode)
TOV behavior at $U_T$ (L-PE)	208 V AC (5 s / withstand mode)
	175 V AC (120 min / withstand mode)
	1332 V AC (200 ms / safe failure mode)
TOV behavior at $U_T$ (N-PE)	1200 V AC (200 ms / safe failure mode)

# EMC filter surge protection device - SFP 1-5/120AC - 2920667

## Technical data

### Protective circuit

Response time $t_A$	$\leq 25$ ns
Capacity (L-N)	1 $\mu$ F $\pm 10$ %
	10 nF $\pm 10$ % (X2-275 V)
Capacity (L-PE)	2.2 nF $\pm 20$ % (Y2-250 V)
Capacity (L-PEN)	2.2 nF $\pm 20$ % (Y2-250 V)
Max. required back-up fuse	20 A (MCB B/general purpose)
	16 A (IT - MCB B/general purpose)
Input attenuation aE, sym.	20 dB ( $\geq 100$ kHz / 50 $\Omega$ )
Input attenuation aE, asym.	30 dB ( $\geq 1$ MHz / 50 $\Omega$ )
Short-circuit current rating $I_{SCCR}$	5 kA AC (TN/TT)
	1 kA AC (IT)

### Indicator/remote signaling

Switching function	PDT contact
Operating voltage	12 V AC ... 250 V AC
	250 V DC (250 mA DC)
Operating current	100 mA AC ... 1 A AC
	1 A DC (48 V DC)
Connection method	Pluggable screw connection
Conductor cross section flexible	0.14 mm <sup>2</sup> ... 1.5 mm <sup>2</sup>
Conductor cross section solid	0.14 mm <sup>2</sup> ... 1.5 mm <sup>2</sup>
Conductor cross section AWG	26 ... 16
Screw thread	M2
Tightening torque	0.25 Nm
Stripping length	7 mm

### Connection data

Connection method	Screw terminal blocks
Conductor cross section flexible	2.5 mm <sup>2</sup> ... 4 mm <sup>2</sup>
Conductor cross section solid	2.5 mm <sup>2</sup> ... 6 mm <sup>2</sup>
Conductor cross section AWG	14 ... 10
Screw thread	M3
Tightening torque	0.5 Nm ... 0.6 Nm
	4.5 lb <sub>f</sub> -in. ... 5.5 lb <sub>f</sub> -in.
Stripping length	8 mm

### UL specifications

SPD Type	2CA
Maximum continuous operating voltage MCOV (L-N)	150 V AC
Maximum continuous operating voltage MCOV (L-G)	150 V AC
Maximum continuous operating voltage MCOV (N-G)	150 V AC
Mode of protection	L-N

## EMC filter surge protection device - SFP 1-5/120AC - 2920667

### Technical data

#### UL specifications

	L-G
	N-G
Power distribution system	Single phase
Nominal frequency	50/60 Hz
Voltage protection rating VPR (L-N)	500 V
Voltage protection rating VPR (L-G)	500 V
Voltage protection rating VPR (N-G)	500 V
Nominal discharge current $I_n$	3 kA
Short-circuit current rating (SCCR)	5 kA

#### Protective circuit, filter

Discharge resistance	820 k $\Omega$
----------------------	----------------

#### Environmental Product Compliance

	Lead 7439-92-1
China RoHS	Environmentally Friendly Use Period = 50
	For details about hazardous substances go to tab "Downloads", Category "Manufacturer's declaration"

### Drawings

# EMC filter surge protection device - SFP 1-5/120AC - 2920667

Diagram

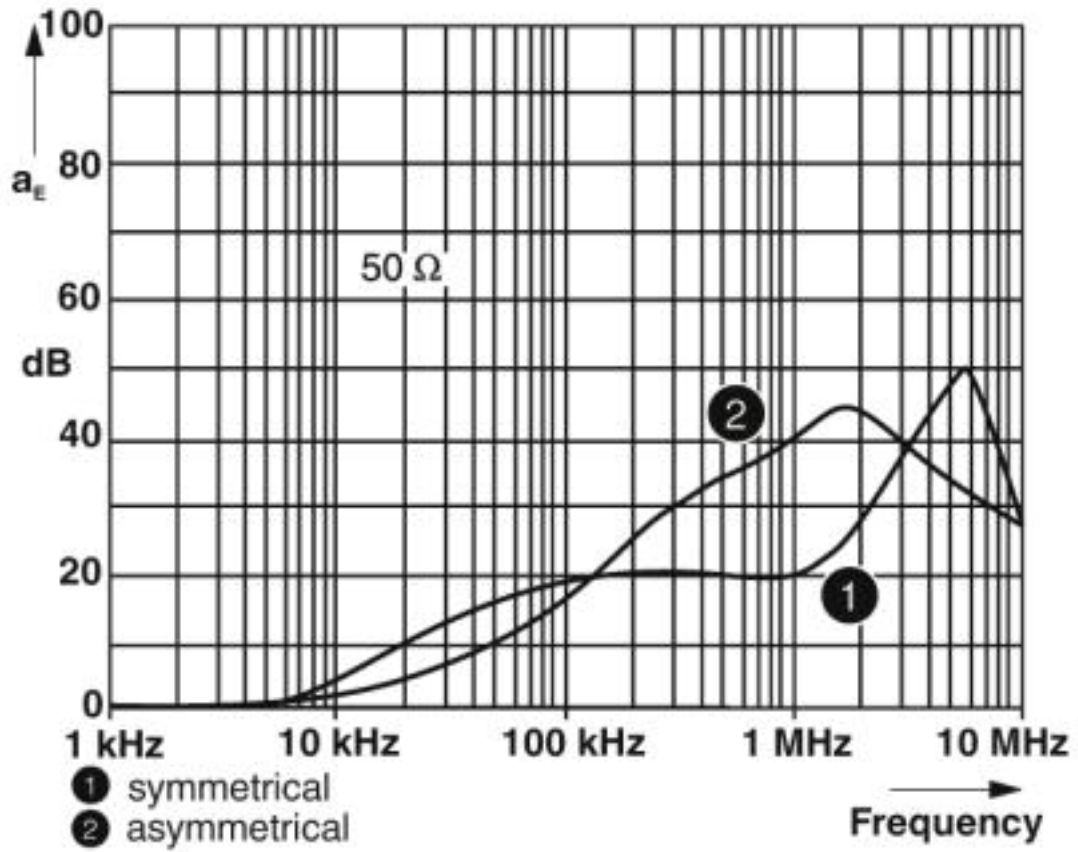

Diagram

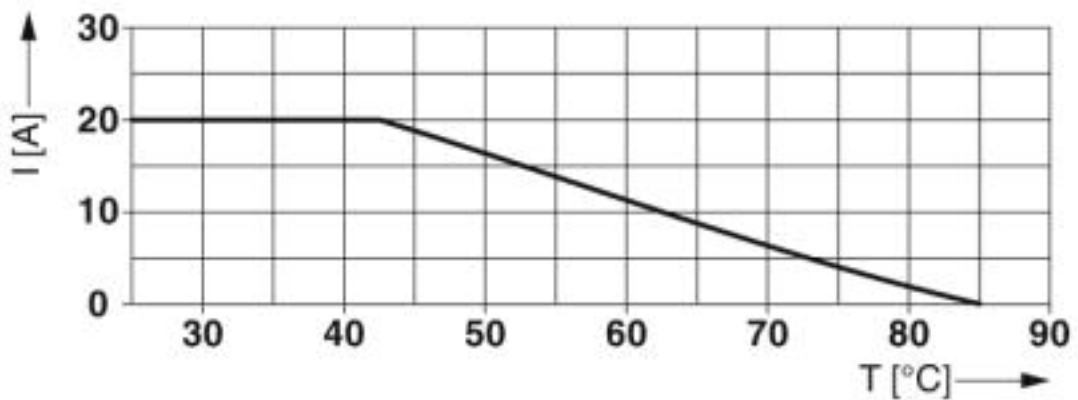

# EMC filter surge protection device - SFP 1-5/120AC - 2920667

Dimensional drawing

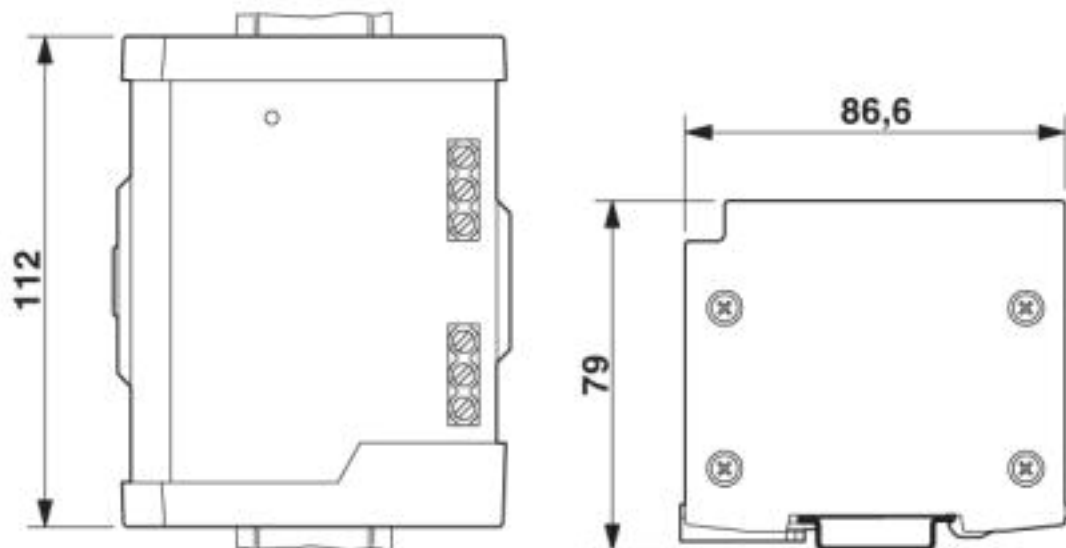

Circuit diagram

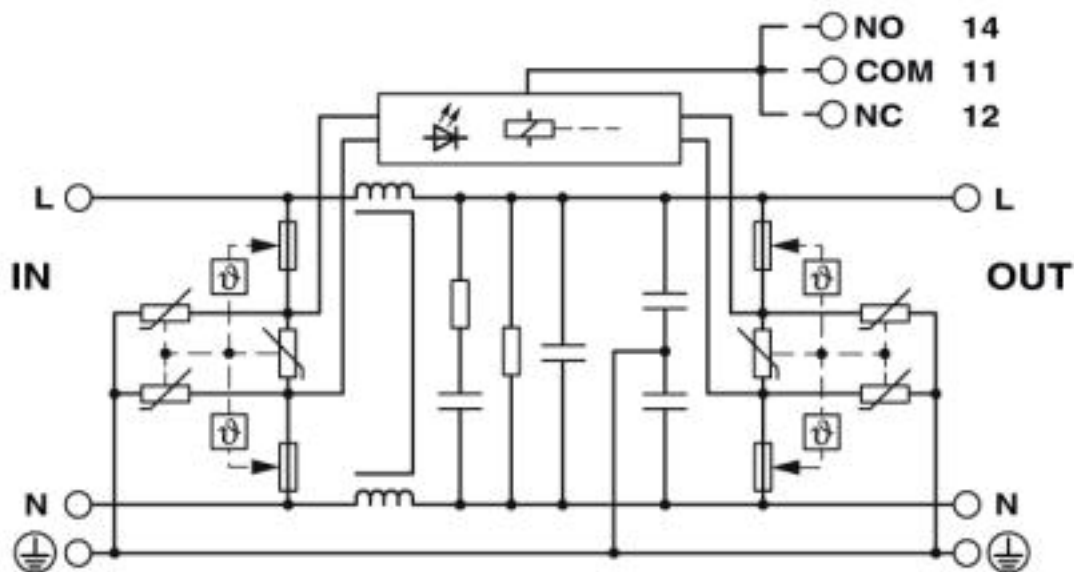

## Classifications

eCl@ss

eCl@ss 4.0	27130800
eCl@ss 4.1	27130800
eCl@ss 5.0	27130800
eCl@ss 5.1	27130800
eCl@ss 6.0	27130800
eCl@ss 7.0	27130806

# EMC filter surge protection device - SFP 1-5/120AC - 2920667

## Classifications

### eCl@ss

eCl@ss 8.0	27130806
eCl@ss 9.0	27130806

### ETIM

ETIM 2.0	EC000942
ETIM 3.0	EC000942
ETIM 4.0	EC000942
ETIM 5.0	EC000942
ETIM 6.0	EC000942
ETIM 7.0	EC000942

### UNSPSC

UNSPSC 6.01	30212010
UNSPSC 7.0901	39121610
UNSPSC 11	39121610
UNSPSC 12.01	39121610
UNSPSC 13.2	39121620
UNSPSC 18.0	39121620
UNSPSC 19.0	39121620
UNSPSC 20.0	39121620
UNSPSC 21.0	39121620

## Approvals

### Approvals

---

#### Approvals

CSA / UL Recognized / cUL Recognized / CSAus / EAC / cULus Recognized

---

#### Ex Approvals

---

### Approval details

CSA		<a href="http://www.csagroup.org/services-industries/product-listing/">http://www.csagroup.org/services-industries/product-listing/</a>	70205391
-----	---	---	----------

UL Recognized		<a href="http://database.ul.com/cgi-bin/XYV/template/LISEXT/1FRAME/index.htm">http://database.ul.com/cgi-bin/XYV/template/LISEXT/1FRAME/index.htm</a>	FILE E 330181
---------------	---	---	---------------

## EMC filter surge protection device - SFP 1-5/120AC - 2920667

### Approvals

cUL Recognized		<a href="http://database.ul.com/cgi-bin/XYV/template/LISEXT/1FRAME/index.htm">http://database.ul.com/cgi-bin/XYV/template/LISEXT/1FRAME/index.htm</a>	FILE E 330181
----------------	---	---	---------------

CSAus		<a href="http://www.csagroup.org/services-industries/product-listing/">http://www.csagroup.org/services-industries/product-listing/</a>	70205391
-------	---	---	----------

EAC			RU C- DE.A*30.B01561
-----	---	--	-------------------------

cULus Recognized			
------------------	---	--	--