

Connector set - SAMPLE PTSM 0,5 PI/PL-4 SET - 1714624

Please be informed that the data shown in this PDF Document is generated from our Online Catalog. Please find the complete data in the user's documentation. Our General Terms of Use for Downloads are valid (<http://phoenixcontact.com/download>)

Connector set, number of positions: 4, pitch: 2.5 mm, color: white

Your advantages

- ✓ White design: Stable color when welding and during use
- ✓ Time saving push-in connection, tools not required
- ✓ Defined contact force ensures that contact remains stable over the long term
- ✓ High current carrying capacity of 6 A in very compact dimensions
- ✓ Inverted connector with pin contacts for touch-proof device outputs or free-hanging cable/cable connections
- ✓ Intuitive locking mechanism prevents accidental disconnection



Key Commercial Data

Packing unit	1 pc
GTIN	 4 055626 379210
GTIN	4055626379210
Weight per Piece (excluding packing)	4.300 g
Custom tariff number	85366990
Country of origin	Poland
Note	Made to Order (non-returnable)

Technical data

Environmental Product Compliance

China RoHS	Environmentally friendly use period: unlimited = EFUP-e
	No hazardous substances above threshold values

Drawings

Connector set - SAMPLE PTSM 0,5 PI/PL-4 SET - 1714624

Dimensional drawing

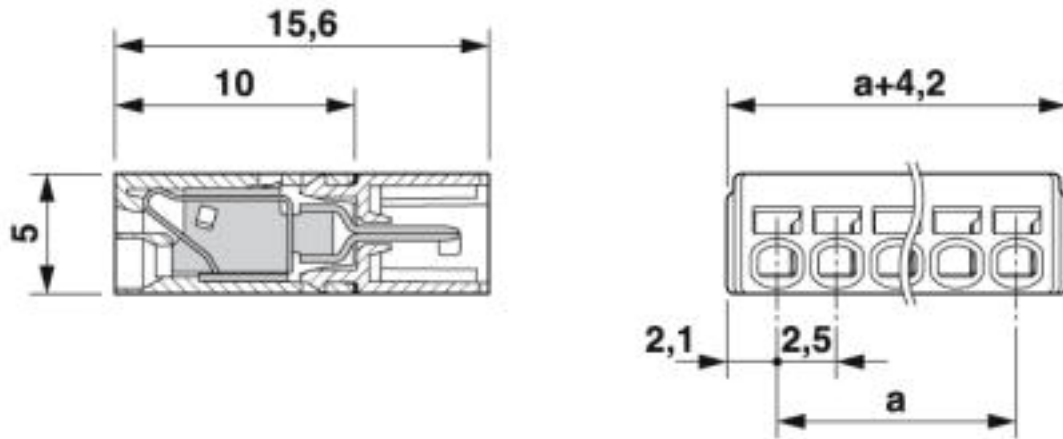

PTSM 0,5/...-PI

Dimensional drawing

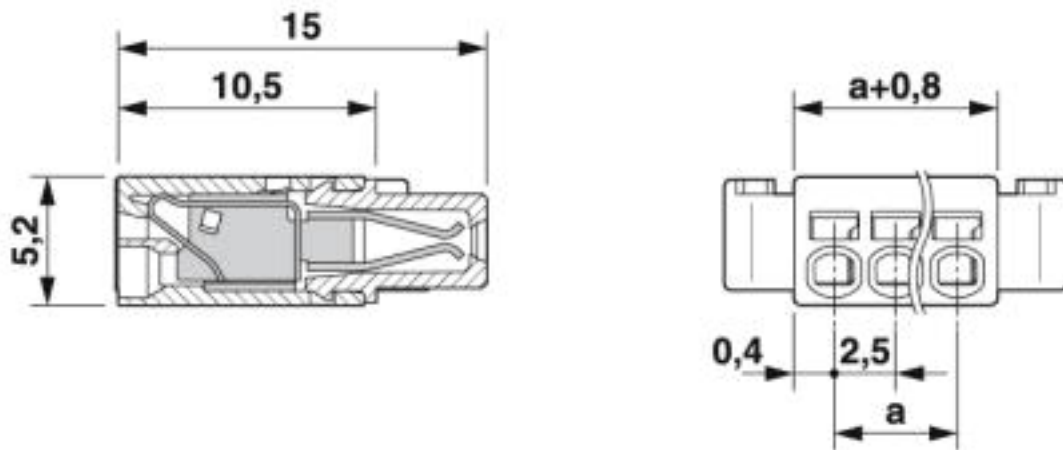

PTSM 0,5/...-PL

Articles in set

Printed-circuit board connector - PTSM 0,5/ 4-PI-2,5 WH - 1709452



PCB connector, nominal current: 6 A, rated voltage (III/2): 160 V, nominal cross section: 0.5 mm², number of positions: 4, pitch: 2.5 mm, connection method: Push-in spring connection, color: white, contact surface: Tin

Connector set - SAMPLE PTSM 0,5 PI/PL-4 SET - 1714624

Articles in set

Printed-circuit board connector - PTSM 0,5/ 4-PL-2,5 WH - 1709460



PCB connector, nominal current: 6 A, rated voltage (III/2): 160 V, nominal cross section: 0.5 mm², number of positions: 4, pitch: 2.5 mm, connection method: Push-in spring connection, color: white, contact surface: Tin

Classifications

eCl@ss

eCl@ss 4.0	27260700
eCl@ss 4.1	27260700
eCl@ss 5.0	27260700
eCl@ss 5.1	27260700
eCl@ss 6.0	27260700
eCl@ss 7.0	27440309
eCl@ss 8.0	27440309
eCl@ss 9.0	27440309

ETIM

ETIM 5.0	EC002638
ETIM 6.0	EC002638
ETIM 7.0	EC002638

Approvals

Approvals

Approvals

EAC

Ex Approvals

Approval details

EAC		B.01687
-----	--	---------

Accessories

Accessories

Connector set - SAMPLE PTSM 0,5 PI/PL-4 SET - 1714624

Accessories

Screwdriver tools

Screwdriver - SZS 0,4X2,0 - 1205202



Micro screwdriver, bladed, size: 0.4 x 2.0 x 60 mm, 2-component grip, with non-slip grip and twist cap