



# Datasheet

## GuardianX

**Part No:**  
GA400.A.305111

### Description:

400-6000MHz Wideband Adhesive Mount Dipole 5G/4G Antenna with 3m TGC-200 & SMA(M)ST

### Features:

Ground plane independent, high efficiency antenna covering 400-6000MHz  
Covers all worldwide cellular 5G/4G Cat-M/ LTE-M and NB-IoT bands  
Adhesive mount dipole antenna  
Low Profile IP67 rated waterproof enclosure  
Cable: 3m TGC-200  
Connector: SMA(M)ST  
Dimensions: 360\*160\*20mm  
RoHS & Reach Compliant



1. Introduction	3
2. Specifications	4
3. Antenna Characteristics	7
4. Radiation Patterns	9
5. Mechanical Drawing	21
6. Packaging	22
<hr/>	
Changelog	23

Taoglas makes no warranties based on the accuracy or completeness of the contents of this document and reserves the right to make changes to specifications and product descriptions at any time without notice. Taoglas reserves all rights to this document and the information contained herein. Reproduction, use or disclosure to third parties without express permission is strictly prohibited.



# 1. Introduction



The Taoglas Guardian X GA400.A is a wideband dipole antenna that has been designed to cover all worldwide 5G and 4G bands, including all sub-6GHz deployments across the 400MHz to 6000MHz spectrum. It is designed primarily for use with 5G/4G modules and devices that require high efficiency and peak gain to deliver best in class throughput on all major cellular bands worldwide including low power bands such as Cat-M/LTE-M and NB-IoT. The GA400.A also covers extended 4G, band 71 and all 5G NR Sub 6GHz bands while also covering 3G/2G bands to allow for fallback when 5G/4G is not available.

Typical applications include:

- Passenger Bus / Rail / Air Applications.
- Automotive and Heavy Equipment Vehicle Tracking and Telematics
- Remote Asset and Pipeline Monitoring
- HD Video Streaming
- First Responder and Emergency Services

The low profile, heavy duty, fully IP67 rated external antenna allows this antenna to be mounted in harsh external environments where a robust, waterproof antenna is required. With high peak gains and high efficiencies over all frequencies from 400-6000MHz, the GA400 is a fantastic solution for wideband cellular applications.

5G applications demand high speed data uplink and downlink. High efficiency and high gain antennas are necessary to achieve the required signal to noise ratio and throughput required to solve these challenges. Low loss TGC-200 cable is used to keep efficiency high over long cable lengths. The cable length and connector types are customizable. Contact your regional Taoglas customer support team for more information.

## 2. Specifications

Electrical								
Band	Frequency (MHz)	Efficiency (%)	Average Gain (dB)	Peak Gain (dBi)	Impedance	Max Input Power	Polarization	Radiation Pattern
<b>4G/3G</b> Band 31	430~470	83.2	-0.8	3.5	50 Ω	2W	Linear	Omni-Directional
<b>5G NR/4G</b> Band 71	617~698	60.8	-2.2	2.4				
<b>4G/3G</b> Band 12,13,14,17,28,29	698~806	64.5	-1.9	2.4				
<b>4G/3G/NB-IoT/Cat M</b> Band 5,8,18,19,20,26,27	824~960	52.2	-2.8	2.6				
<b>5G NR/4G</b> Band 21,32,74,75,76	1427~1518	82.5	-0.8	4				
<b>4G/3G</b> Band 1,2,3,4,9,23,25,35,39,66	1710~2200	71.4	-1.5	3.8				
<b>4G/3G</b> Band 7,38,41	2490~2690	53.2	-2.7	4.6				
<b>5G NR/4G</b> Band 22,42,48,77,78,79	3300~3800	49.4	-3.1	2.2				
<b>LTE5200/ Wi-Fi 5800</b>	5150~5925	53.9	-2.7	5.3				

<b>Mechanical</b>	
<b>Height</b>	16.5mm
<b>Planner Dimension</b>	360mm * 160mm
<b>Casing</b>	Material
<b>Cable</b>	1M TGC200 – Fully Customizable
<b>Connector</b>	SMA-Plug – Fully Customizable
<b>Sealant</b>	Rubber Stopper
<b>Weight</b>	550 g (Not Included Package)
<b>Environmental</b>	
<b>Protection</b>	IP67
<b>Temperature Range</b>	-40°C to 85°C
<b>Humidity</b>	Non-condensing 65°C 95% RH
<b>Cable Pull</b>	TGC200 9Kgf

5G/4G Bands			
Band Number	5G NR / FR1 / LTE / LTE-Advanced / WCDMA / HSPA / HSPA+ / TD-SCDMA		
	Uplink	Downlink	Covered
1	UL: 1920 to 1980	DL: 2110 to 2170	✓
2	UL: 1850 to 1910	DL: 1930 to 1990	✓
3	UL: 1710 to 1785	DL: 1805 to 1880	✓
4	UL: 1710 to 1755	DL: 2110 to 2155	✓
5	UL: 824 to 849	DL: 869 to 894	✓
7	UL: 2500 to 2570	DL: 2620 to 2690	✓
8	UL: 880 to 915	DL: 925 to 960	✓
9	UL: 1749.9 to 1784.9	DL: 1844.9 to 1879.9	✓
11	UL: 1427.9 to 1447.9	DL: 1475.9 to 1495.9	✓
12	UL: 699 to 716	DL: 729 to 746	✓
13	UL: 777 to 787	DL: 746 to 756	✓
14	UL: 788 to 798	DL: 758 to 768	✓
17	UL: 704 to 716	DL: 734 to 746	✓
18	UL: 815 to 830	DL: 860 to 875	✓
19	UL: 830 to 845	DL: 875 to 890	✓
20	UL: 832 to 862	DL: 791 to 821	✓
21	UL: 1447.9 to 1462.9	DL: 1495.9 to 1510.9	✓
22	UL: 3410 to 3490	DL: 3510 to 3590	✓
23	UL: 2000 to 2020	DL: 2180 to 2200	✓
24	UL: 1625.5 to 1660.5	DL: 1525 to 1559	✓
25	UL: 1850 to 1915	DL: 1930 to 1995	✓
26	UL: 814 to 849	DL: 859 to 894	✓
27	UL: 807 to 824	DL: 852 to 869	✓
28	UL: 703 to 748	DL: 758 to 803	✓
29	UL: -	DL: 717 to 728	✓
30	UL: 2305 to 2315	DL: 2350 to 2360	✓
31	UL: 452.5 to 457.5	DL: 462.5 to 467.5	✓
32	UL: -	DL: 1452 – 1496	✓
35		1850 to 1910	✓
38		2570 to 2620	✓
39		1880 to 1920	✓
40		2300 to 2400	✓
41		2496 to 2690	✓
42		3400 to 3600	✓
43		3600 to 3800	✓
48		3550 to 3700	✓
66	UL: 1710-1780	DL: 2110-2200	✓
71		617 to 698	✓
74/75/76		1427 to 1518	✓
77		3300 to 4200	✓
78		3300 to 3800	✓
79		4400 to 5000	✓

### 3. Antenna Characteristics

#### 3.1 Return Loss

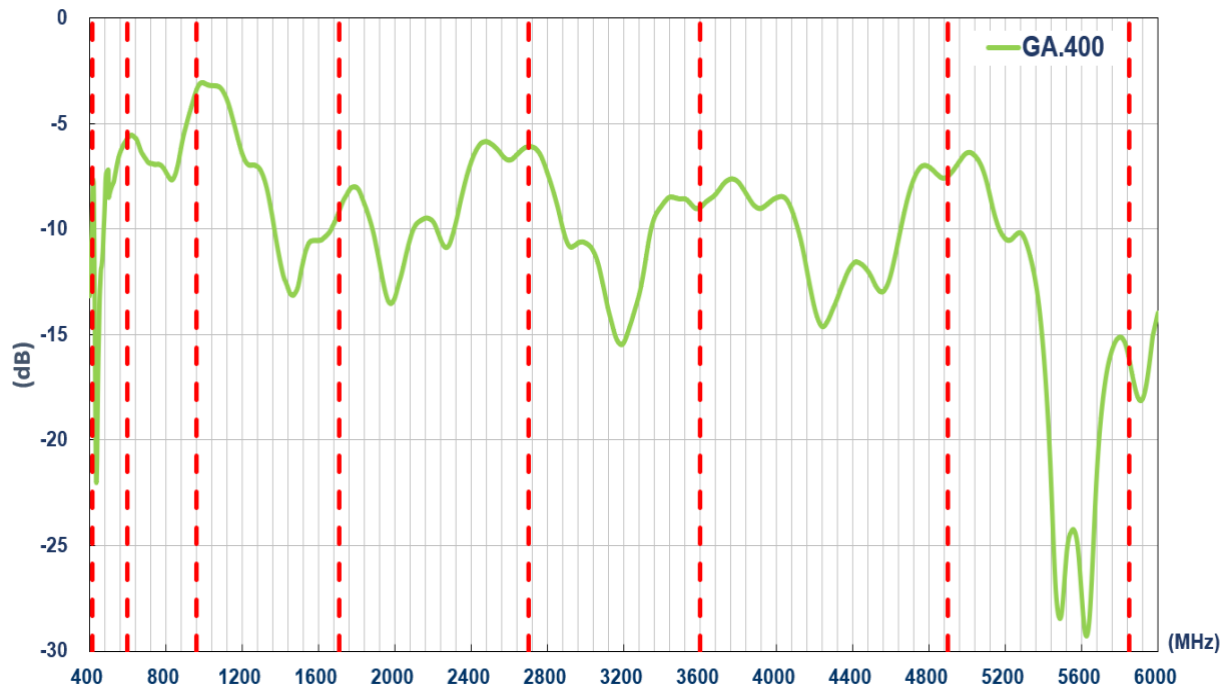

#### 3.2 Efficiency

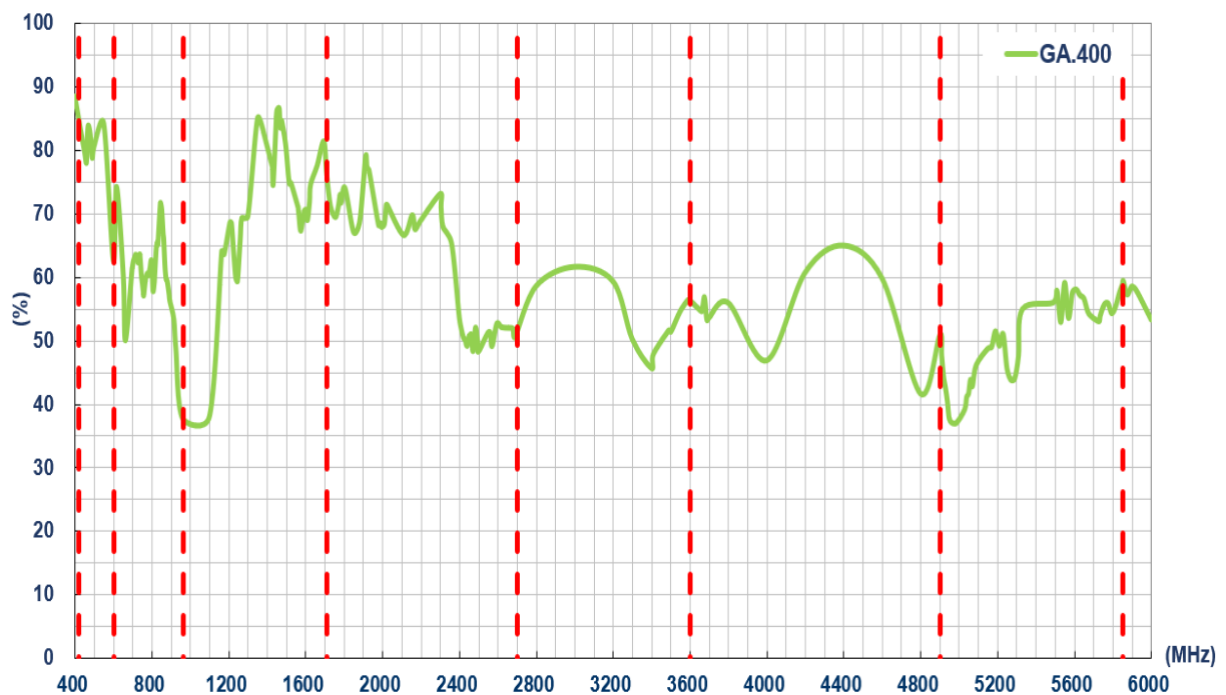

### 3.3 Average Gain

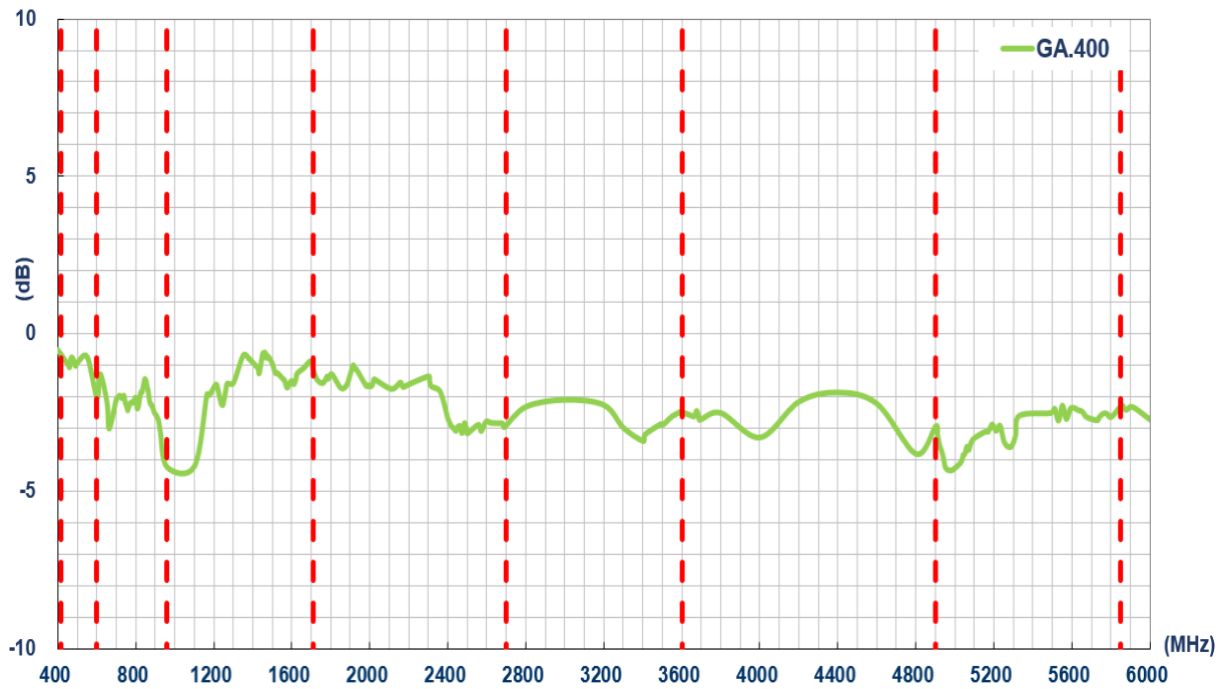

### 3.4 Peak Gain

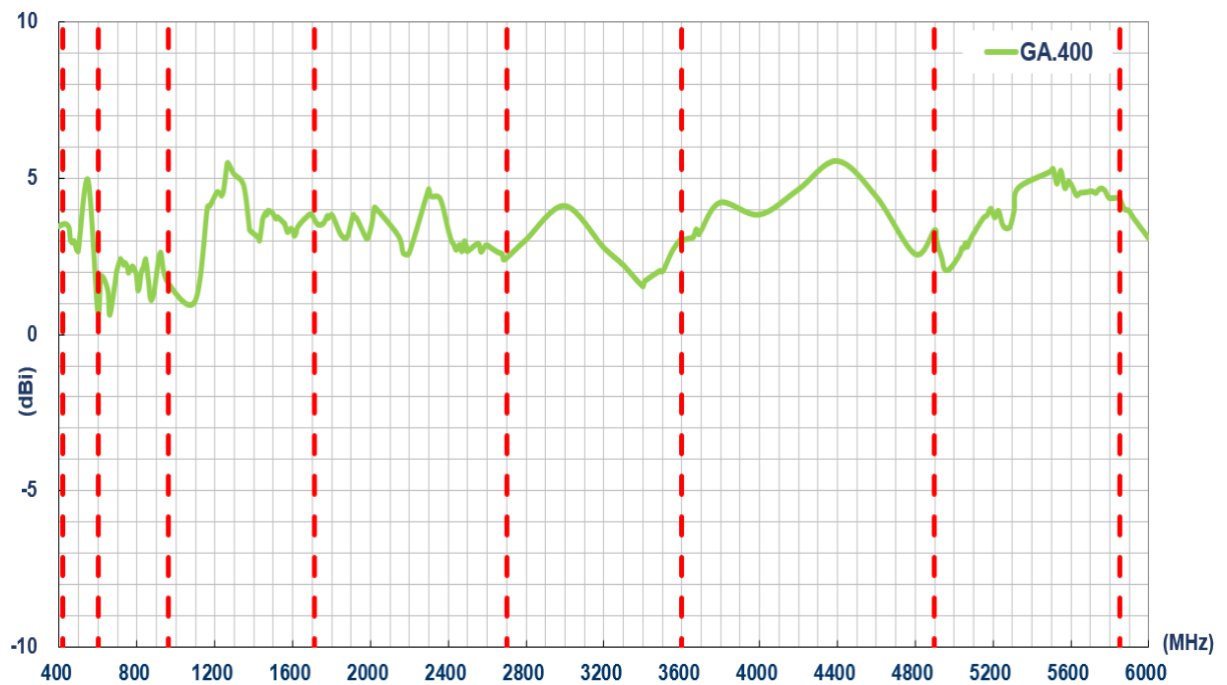



## 4. Radiation Patterns

### 4.1 Test Setup



Free space

4.2 433MHz 3D and 2D Radiation Patterns

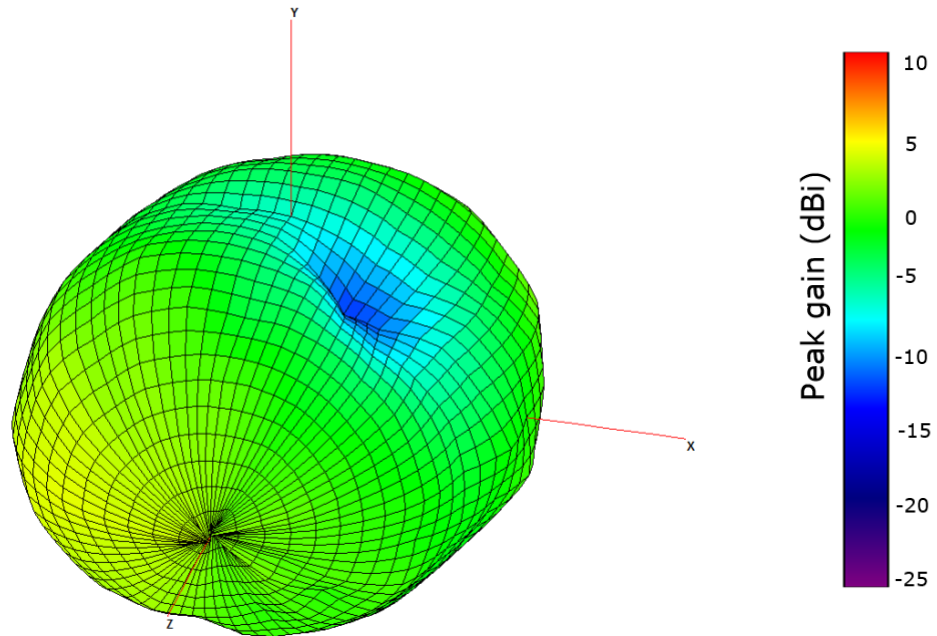

XY Plane

XZ Plane

YZ Plane

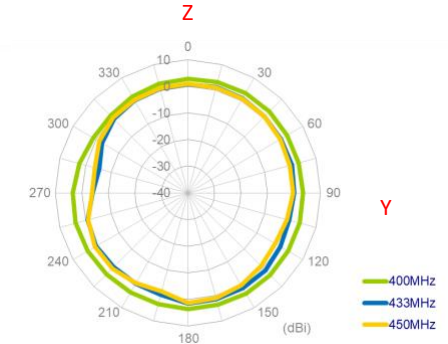
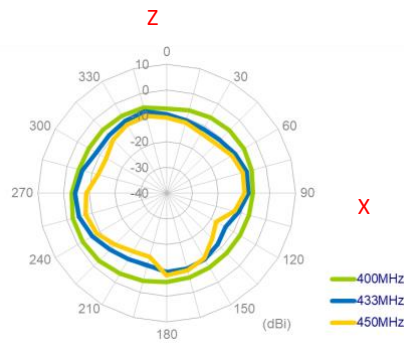
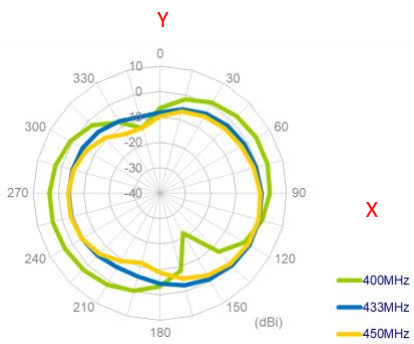

### 4.3 652MHz 3D and 2D Radiation Patterns

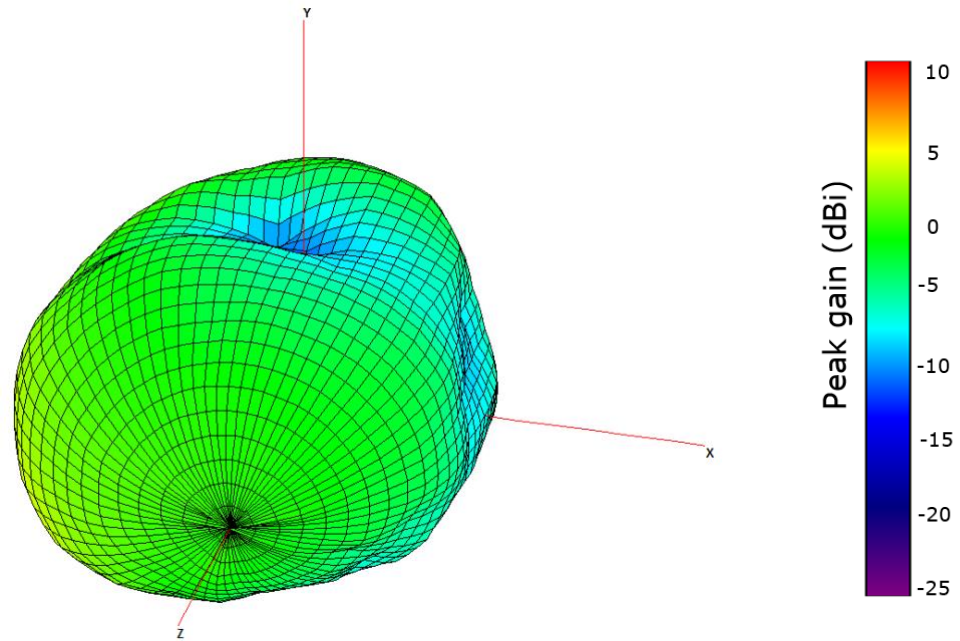

XY Plane	XZ Plane	YZ Plane
----------	----------	----------

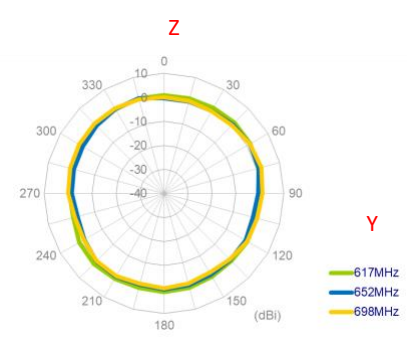
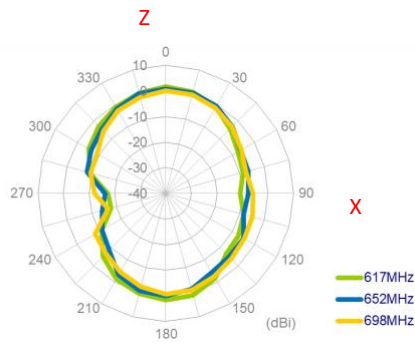
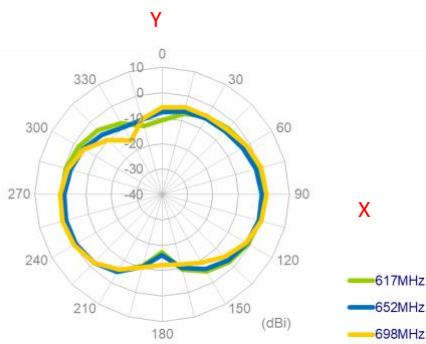

## 4.4 751MHz 3D and 2D Radiation Patterns

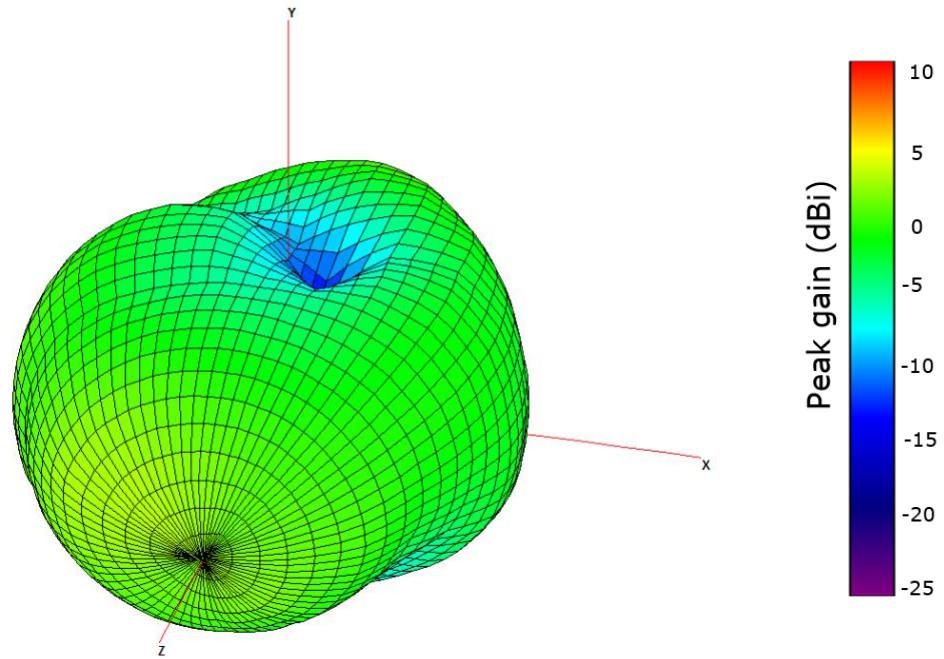

XY Plane

XZ Plane

YZ Plane

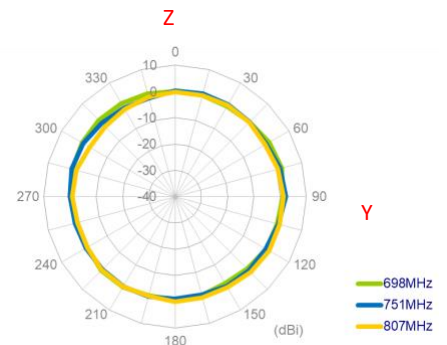
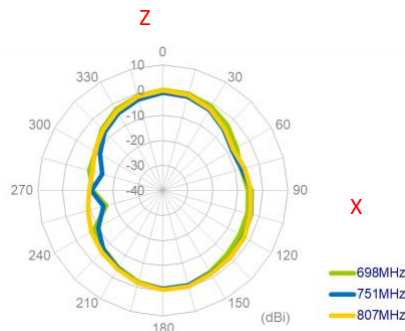
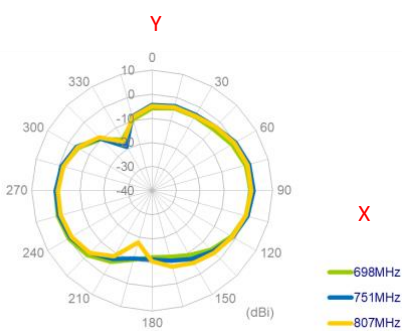

## 4.5 890MHz 3D and 2D Radiation Patterns

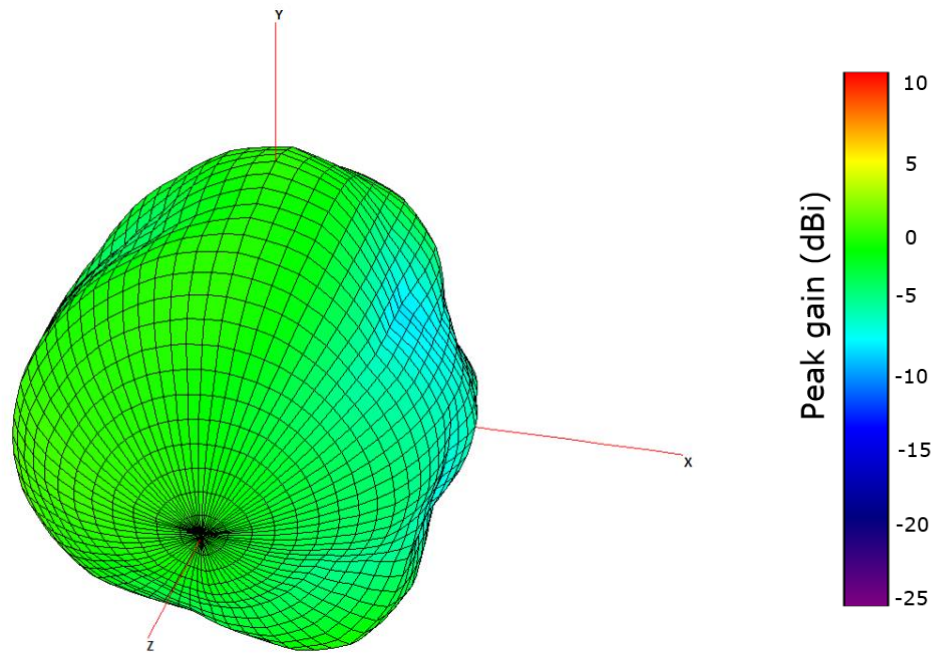

XY Plane      XZ Plane      YZ Plane

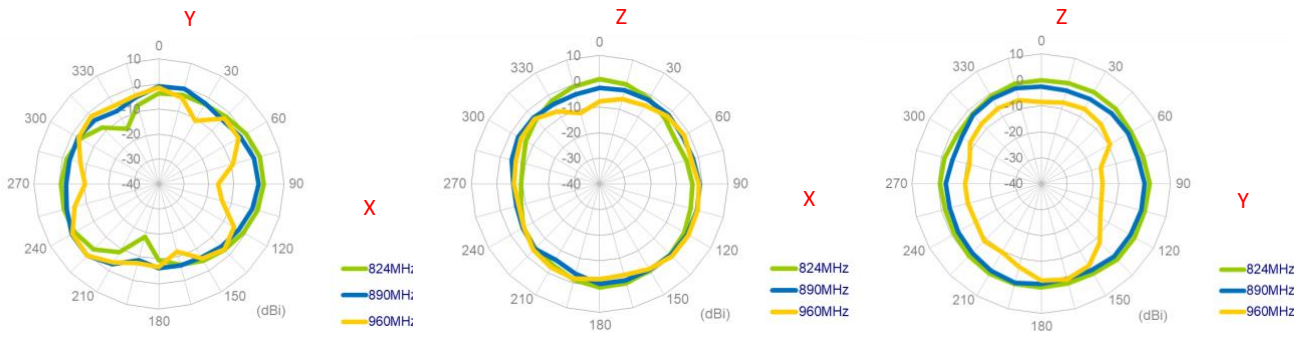



## 4.6 1470MHz 3D and 2D Radiation Patterns

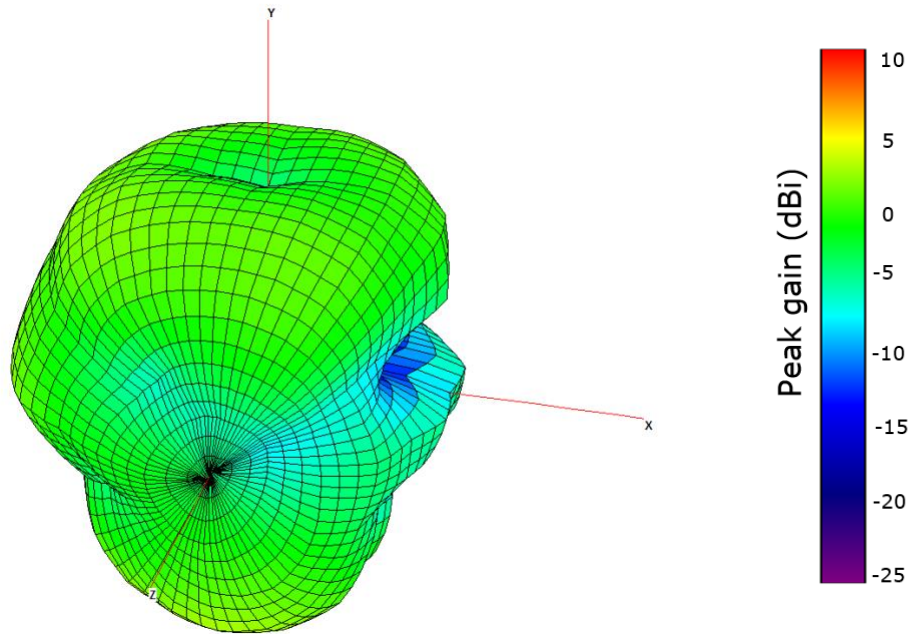

XY Plane

XZ Plane

YZ Plane

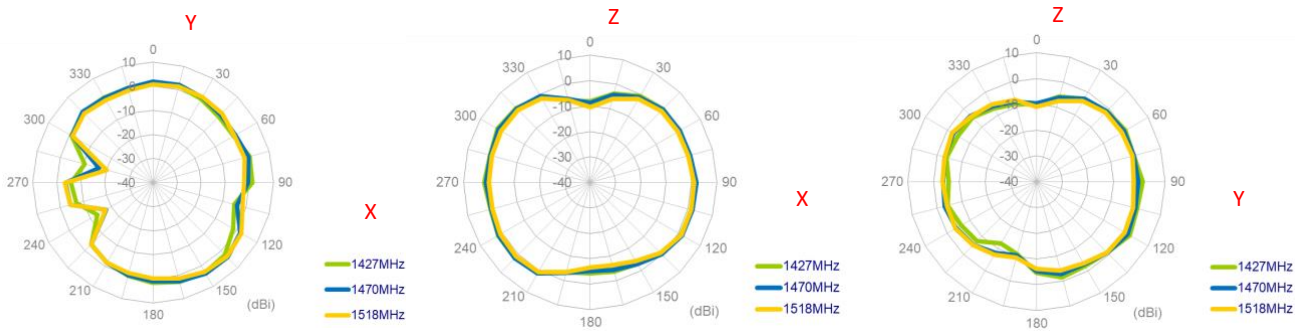

## 4.7 1805MHz 3D and 2D Radiation Patterns

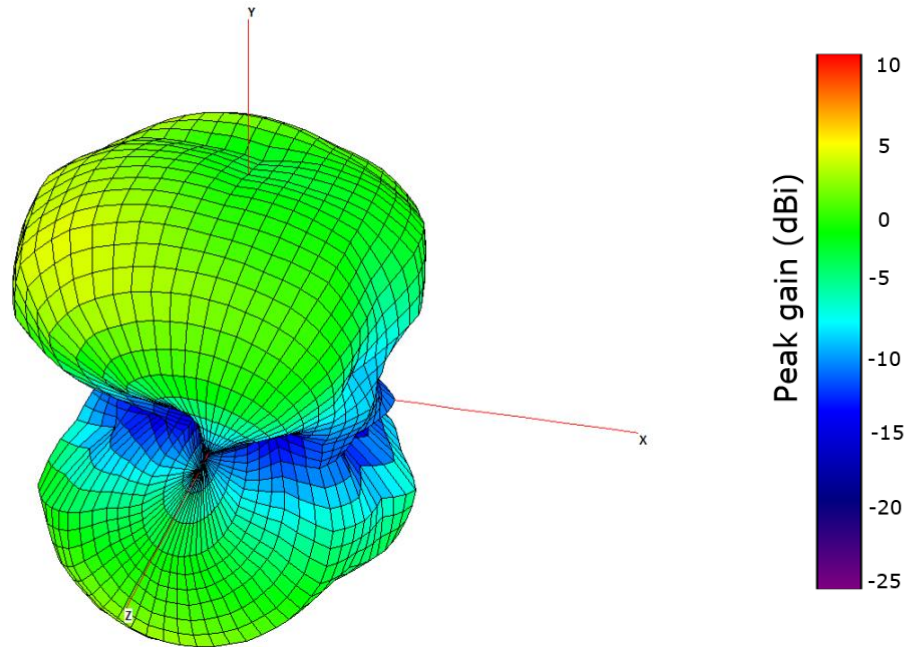

XY Plane

XZ Plane

YZ Plane

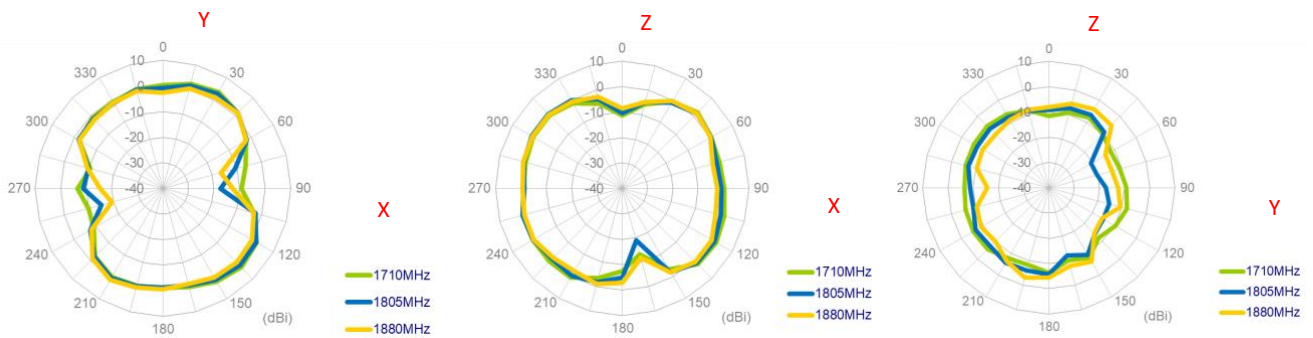

## 4.8 1920MHz 3D and 2D Radiation Patterns

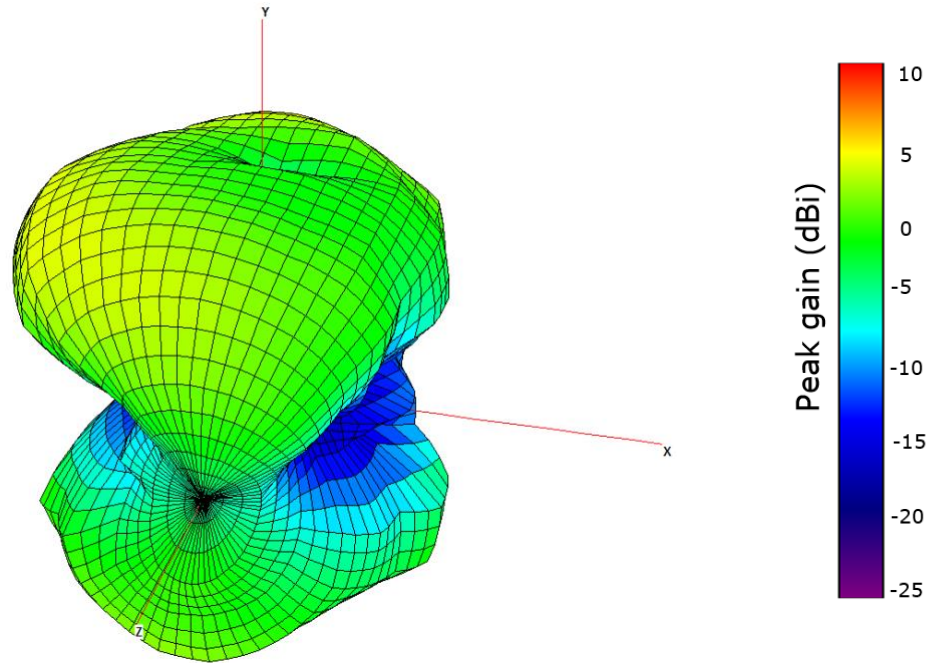

XY Plane

XZ Plane

YZ Plane

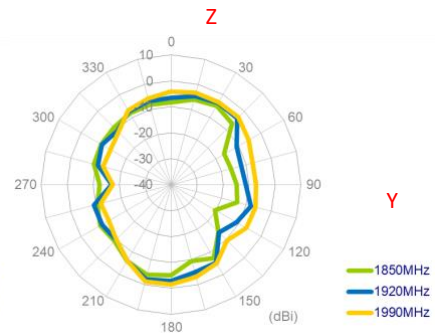
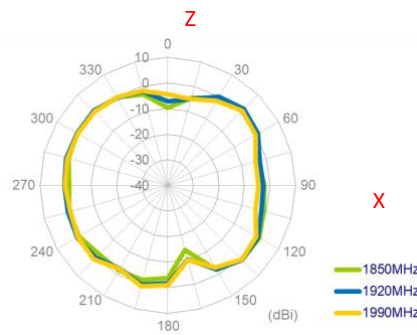
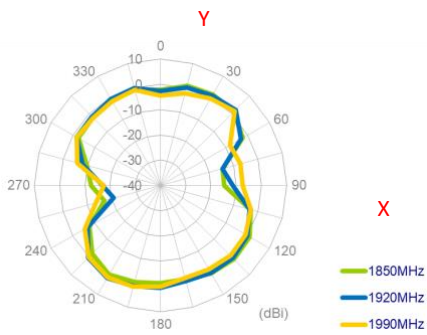



## 4.9 1990MHz 3D and 2D Radiation Patterns

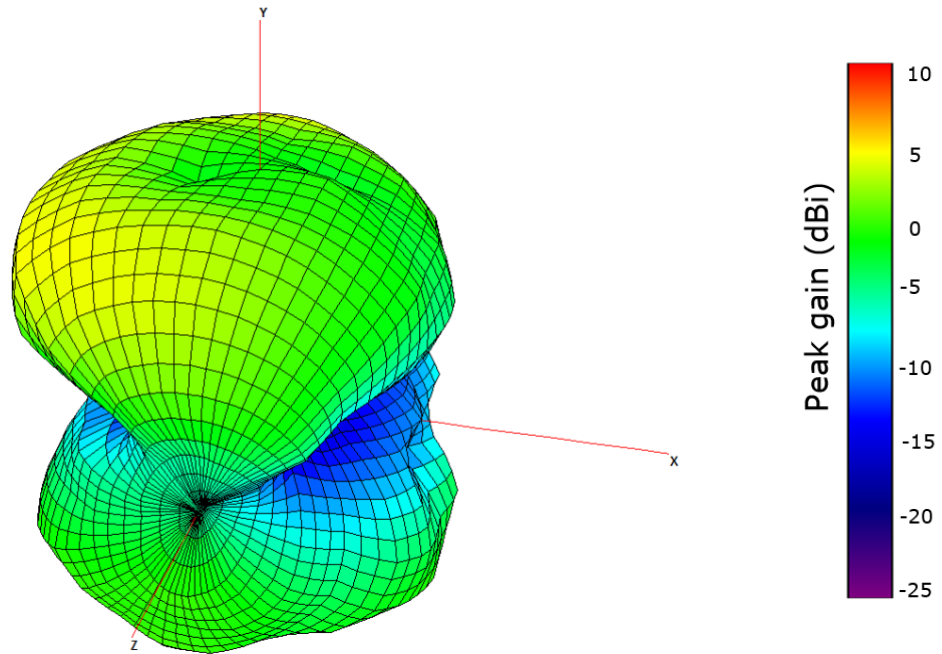

XY Plane

XZ Plane

YZ Plane

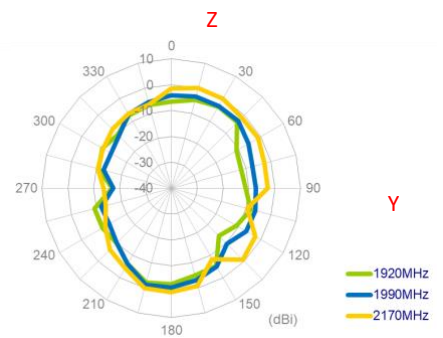
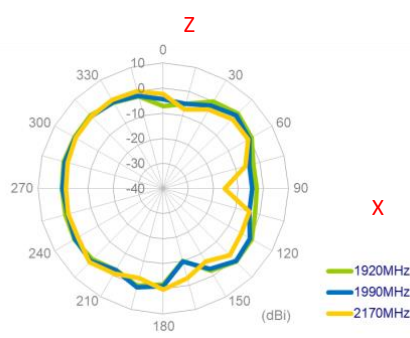
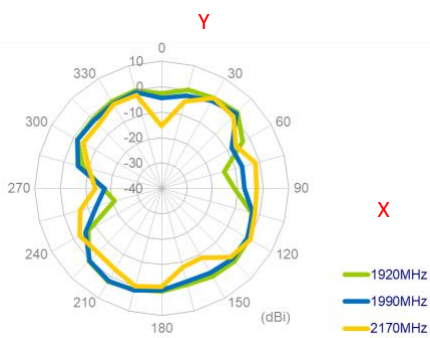

4.10 2595MHz 3D and 2D Radiation Patterns

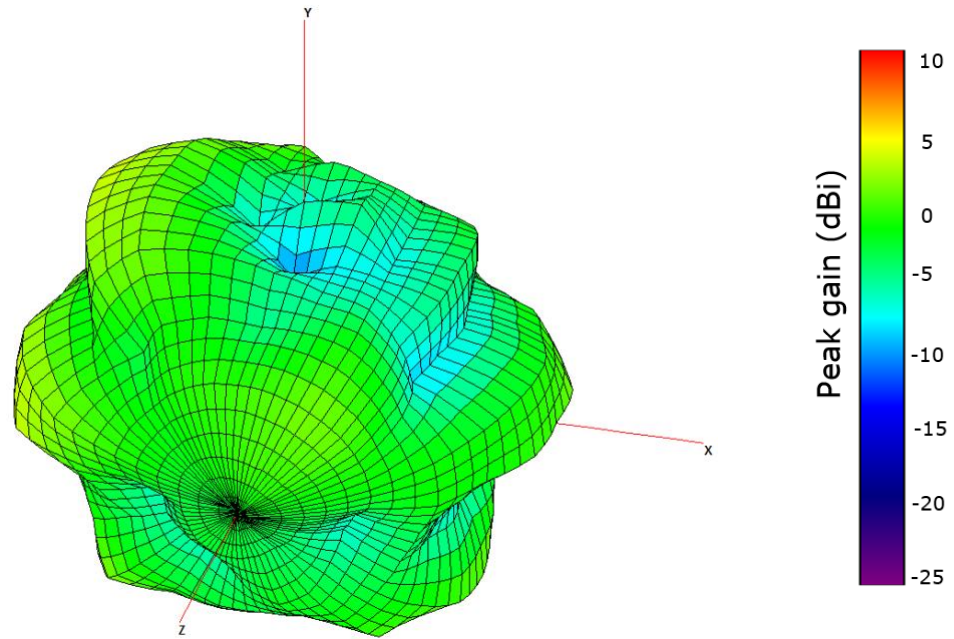

XY Plane

XZ Plane

YZ Plane

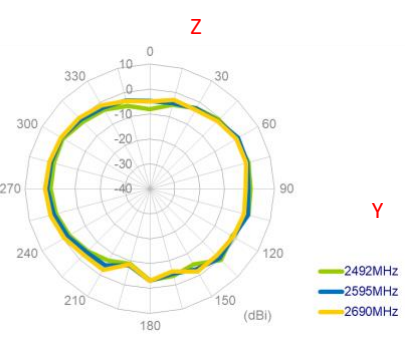
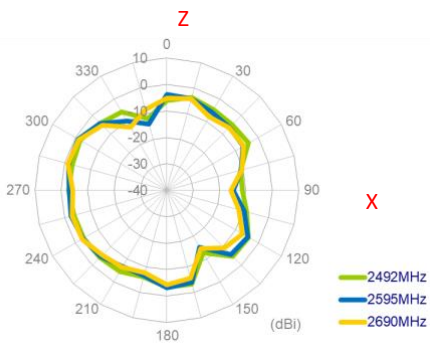
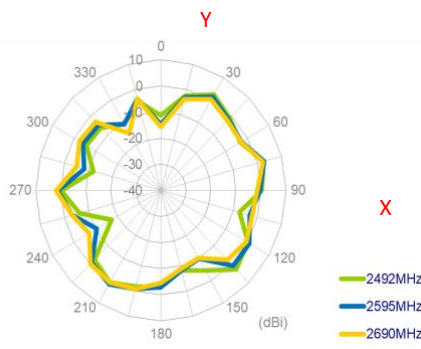

## 4.11 3550MHz 3D and 2D Radiation Patterns

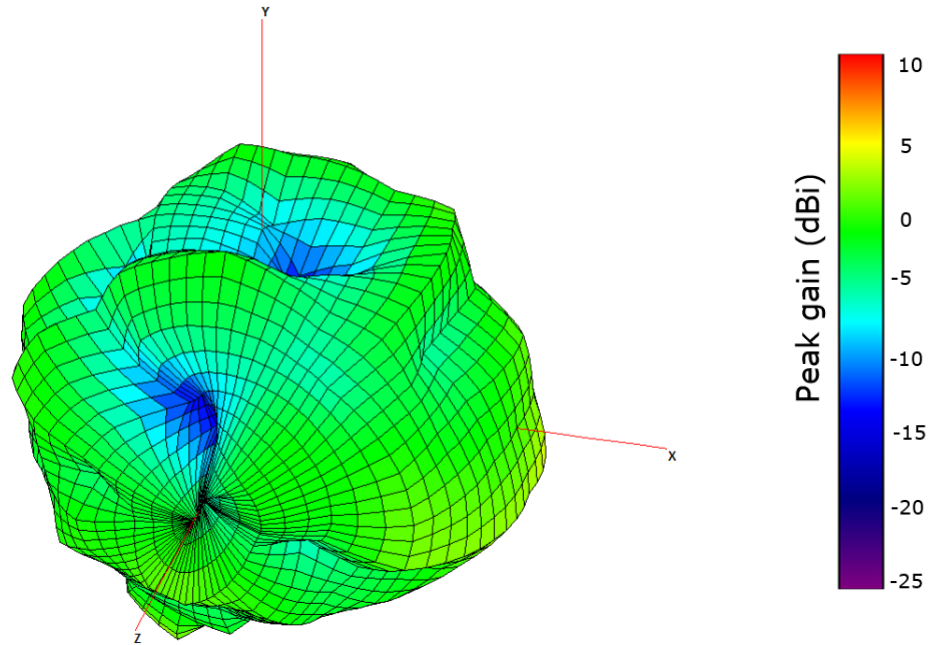

XY Plane                      XZ Plane                      YZ Plane

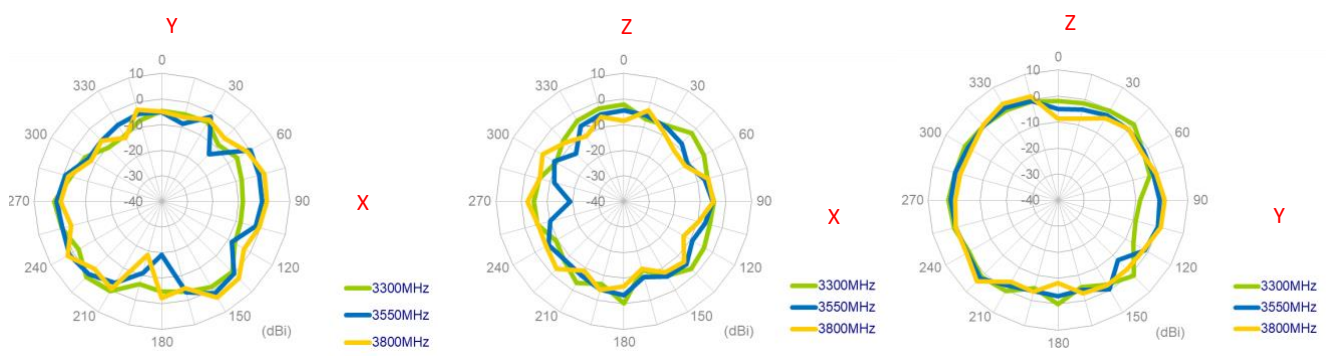

4.12 5530MHz 3D and 2D Radiation Patterns

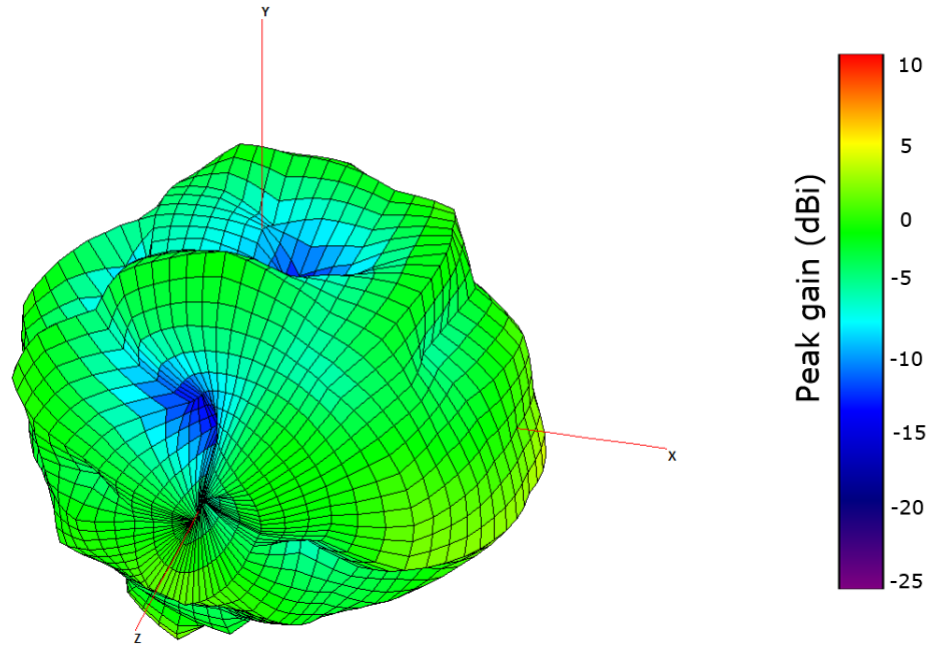

XY Plane      XZ Plane      YZ Plane

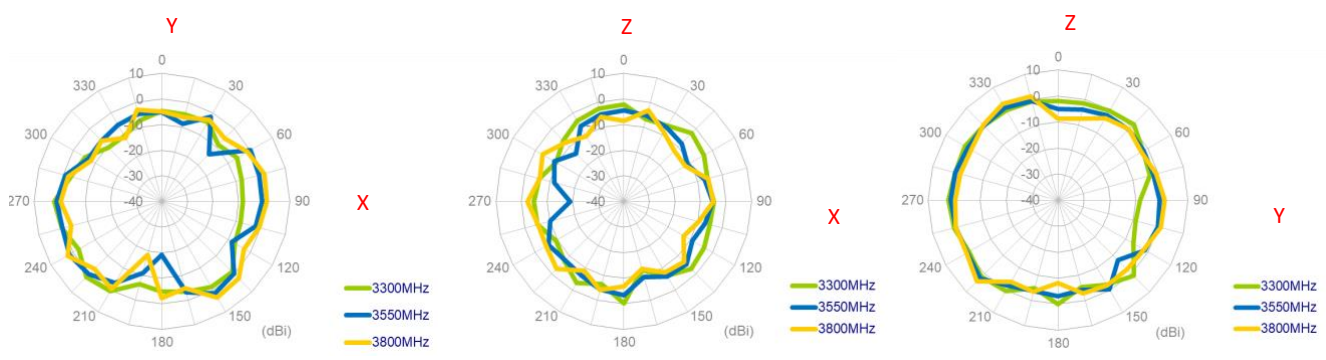

# 5. Mechanical Drawing (Units: mm)

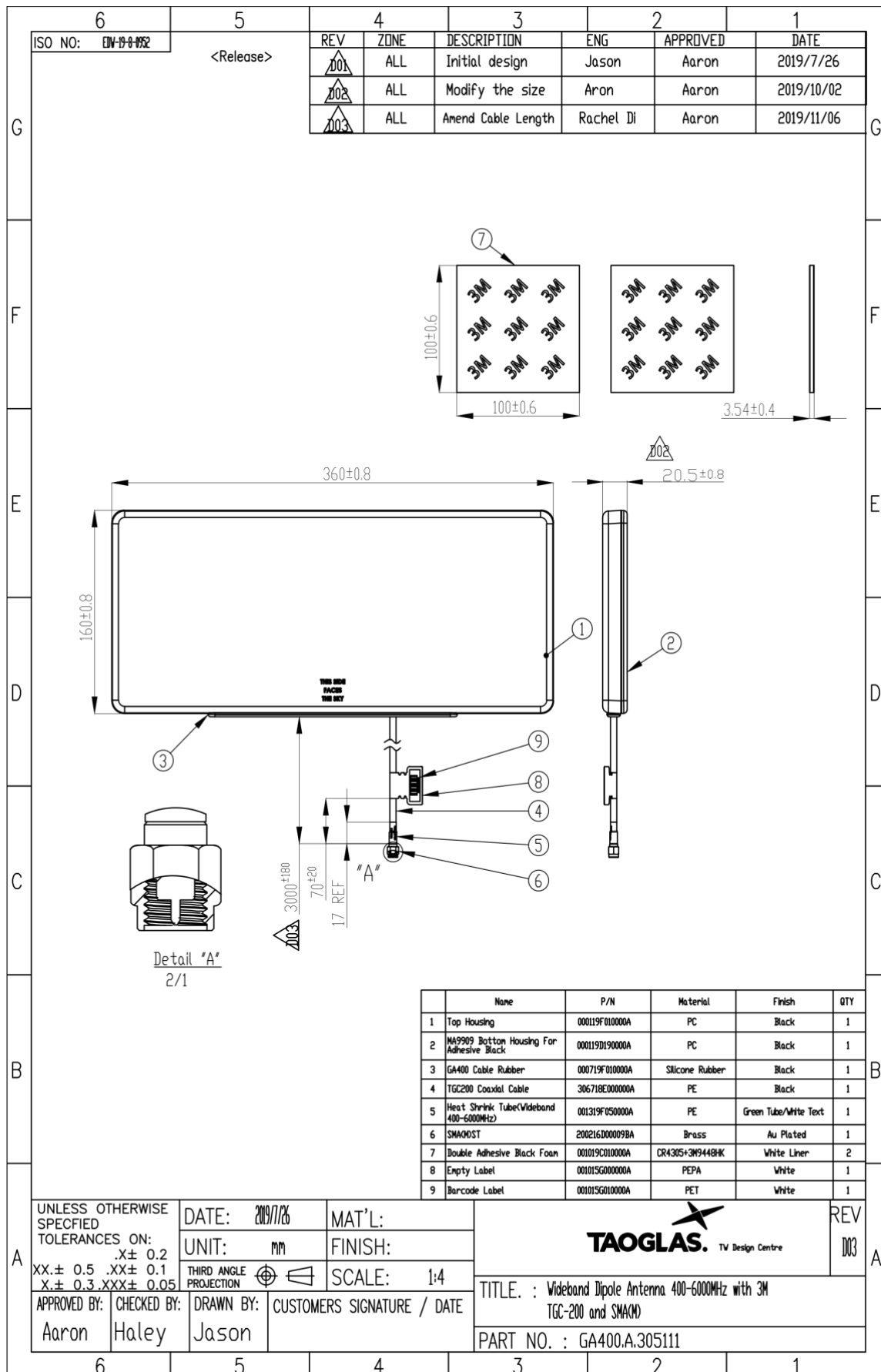

## 7. Packaging

1pcs GA400.A.305111 per PE Bag  
Weight - 550g

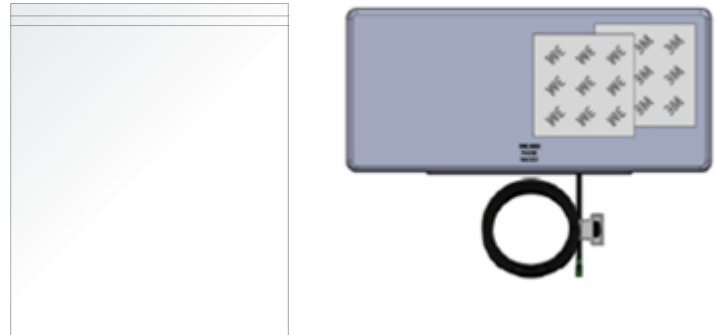

7pcs GA400.A.305111 per carton  
Dimensions - 430\*380\*280mm  
Weight - 4Kg

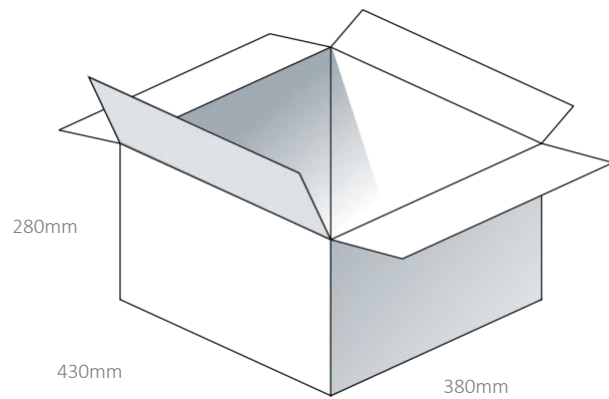

Pallet Dimensions:  
1280\*1200\*1000mm  
24 Cartons Per Pallet  
6 Cartons Per Layer  
4 Layers

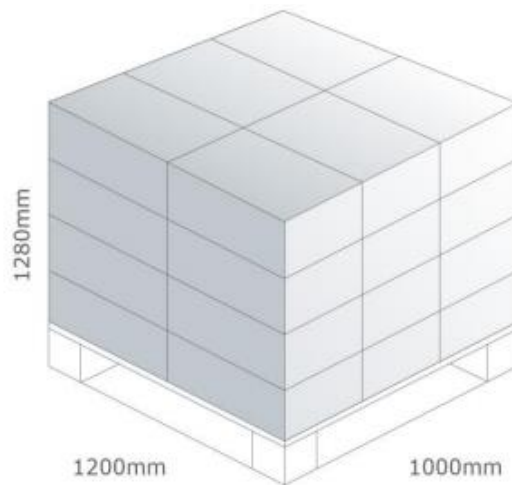

Changelog for the datasheet

**SPE-19-8-138 – GA400.A.305111**

<b>Revision: A (Original First Release)</b>	
Date:	2019-12-04
Notes:	
Author:	Jack Conroy

**Previous Revisions**



**TAOGLAS**®

[www.taoglas.com](http://www.taoglas.com)

