

SV4 SERIES ANTI-VANDAL SWITCH

ANTI-VANDAL SWITCHES
DETECTOR SWITCHES
DIP SWITCHES
KEYLOCK SWITCHES
NAVIGATION SWITCHES
PUSHBUTTON SWITCHES
ROCKER SWITCHES
ROTARY SWITCHES
SLIDE SWITCHES
SNAP ACTION SWITCHES
TACTILE SWITCHES
TOGGLE SWITCHES
CAP OPTIONS



APPLICATIONS / MARKETS



SPECIFICATIONS

Electrical Rating: 2A, 36VDC
Electrical Life: 200,000 Cycles
Contact Resistance: 50mΩ Max. at 1A 12VDC
Dielectric Strength: 2,000V RMS at sea level
Operating/Storage Temperature: -20°C to 70°C
Travel: 1.80mm
Moisture Protection: IP67
Contact Arrangement: SPST
Actuation Force: 4.5 N
Panel Thickness: 1-6mm
Mounting Nut Torque: 1-3Nm

FEATURES & BENEFITS

- Short body design
- 19mm diameter panel cutout
- Multiple LED options
- Ring or ring & power symbol illumination available
- IP67 rated
- SPST
- Soldered wire leads (500mm long) optional

PART NUMBER CONFIGURATOR

Series	Actuator Options	Terminal Options	Function Options	Body Finish Options	Actuator Finish Options	Lens Style Options	LED-Color Options	Illumination Voltage Options
<input type="text" value="SV4"/>	<input type="text" value="F - Flat"/>	<input type="text" value="2 - Solder
W - Wire Leads
500mm long"/>	<input type="text" value="3 - 1 Pole
Off - (On)*"/>	<input type="text" value="S - Stainless Steel"/>	<input type="text" value="S - Stainless Steel"/>	<input type="text" value="3 - Ring moveable with Actuator
6 - Ring /Power moveable with Actuator"/>	<input type="text" value="0 - White
1 - Red
3 - Green
4 - Blue
5 - Yellow
G - Red/Green
H - Red/Blue"/>	<input type="text" value="1 - Base Voltage
3 - 6V, 180Ω
4 - 12V, 470Ω
5 - 24V, 1000Ω"/>

NOTES:
 *() denotes function is momentary

Specifications subject to change without notice 11.4.2019



E-SWITCH®

www.e-switch.com

800.867.2717

1

SV4 SERIES ANTI-VANDAL SWITCH

BODY DIMENSIONS

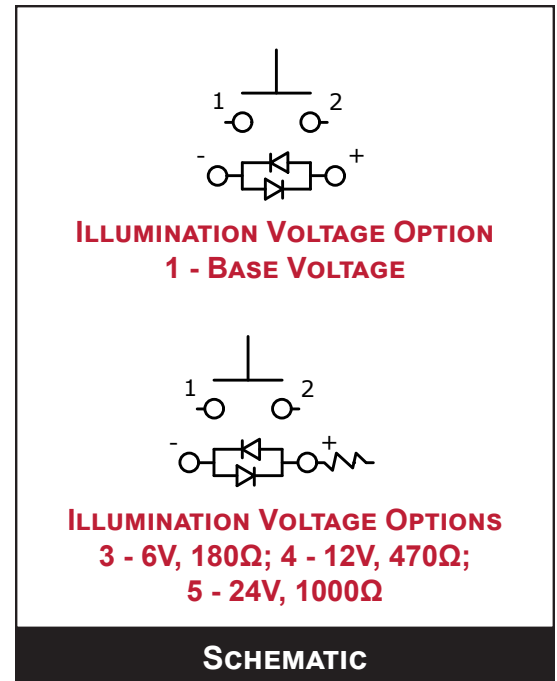
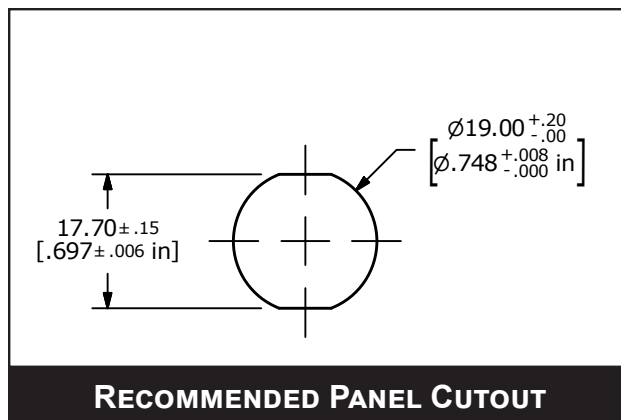
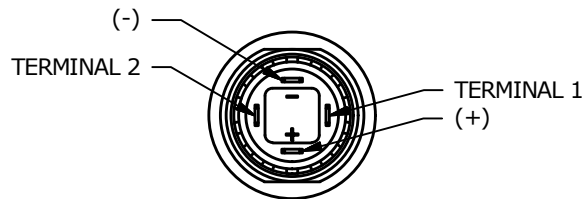
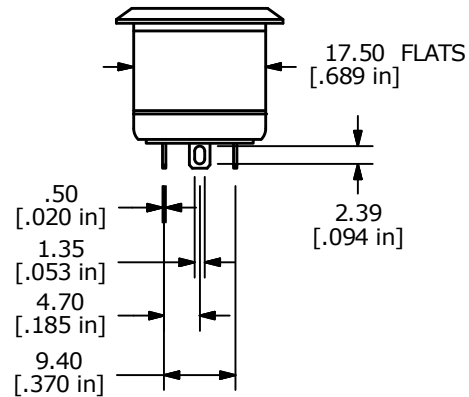
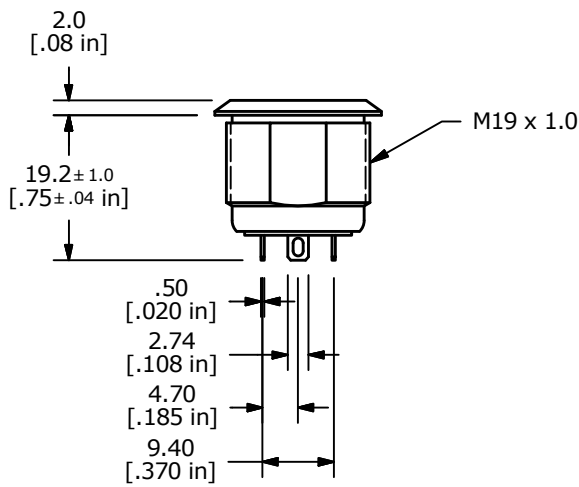
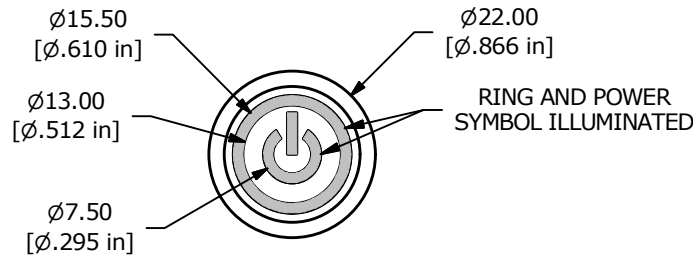

ANTI-VANDAL SWITCHES
 DETECTOR SWITCHES
 DIP SWITCHES
 KEYLOCK SWITCHES
 NAVIGATION SWITCHES
 PUSHBUTTON SWITCHES
 ROCKER SWITCHES
 ROTARY SWITCHES
 SLIDE SWITCHES
 SNAP ACTION SWITCHES
 TACTILE SWITCHES
 TOGGLE SWITCHES
 CAP OPTIONS

SV4 SERIES ANTI-VANDAL SWITCH

ACTUATOR OPTIONS

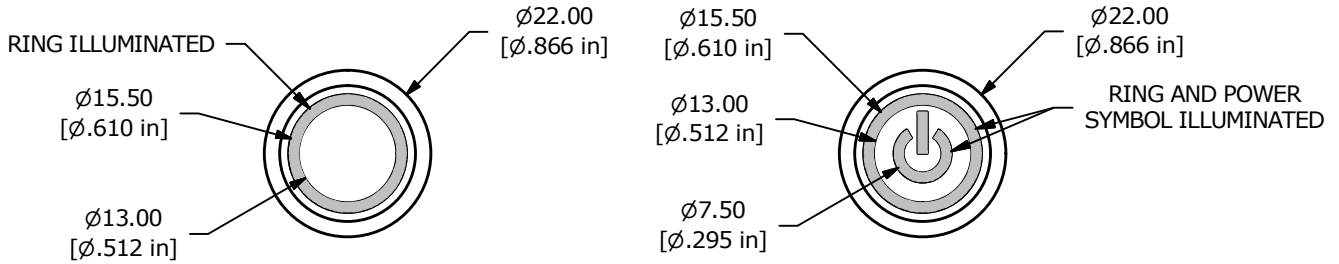

WIRE LEAD OPTION

SWITCH	WIRE	LENGTH
SW1-1	WIRE, 20AWG AWM UL3385, BLACK	500.0 [19.7 in]
SW1-2	WIRE, 20AWG AWM UL3385, BLACK	500.0 [19.7 in]
SW1- (-)	WIRE, 20AWG AWM UL3385, GREEN	500.0 [19.7 in]
SW1- (+)	WIRE, 20AWG AWM UL3385, RED	500.0 [19.7 in]

