

Sure Cross® MultiHop H2 Data Radio



Datasheet

The Sure Cross® wireless system is a radio frequency network with integrated I/O that operates in most environments to eliminate the need for wiring runs. Wireless MultiHop data radio networks are formed around a MultiHop master and one or more slaves and extend the range of a Modbus or other serial communication network.



- Wireless industrial I/O device with four PNP discrete inputs, four PNP discrete outputs, two 0 to 20 mA analog inputs, and two 0 to 20 mA analog outputs
- Selectable transmit power levels of 250 mW or 1 Watt for 900 MHz models and 65 mW for 2.4 GHz models
- 10 V DC to 30 V DC power input
- Self-healing, auto-routing RF network with multiple hops extends the network's range
- Serial and I/O communication on a Modbus platform
- Message routing improves link performance
- DIP switches select operational modes: master, repeater, or slave
- Built-in site survey mode enables rapid assessment of a location's RF transmission properties
- Frequency Hopping Spread Spectrum (FHSS) technology ensures reliable data delivery within the unlicensed Industrial, Scientific, and Medical (ISM) band



Important: Please download the complete Sure Cross® MultiHop Data Radio technical documentation, available in multiple languages, from www.bannerengineering.com for details on the proper use, applications, Warnings, and installation instructions of this device.



Important: Por favor descargue desde www.bannerengineering.com toda la documentación técnica de los Sure Cross® MultiHop Data Radio, disponibles en múltiples idiomas, para detalles del uso adecuado, aplicaciones, advertencias, y las instrucciones de instalación de estos dispositivos.



Important: Veuillez télécharger la documentation technique complète des Sure Cross® MultiHop Data Radio sur notre site www.bannerengineering.com pour les détails sur leur utilisation correcte, les applications, les notes de sécurité et les instructions de montage.



WARNING:

- **Do not use this device for personnel protection**
- Using this device for personnel protection could result in serious injury or death.
- This device does not include the self-checking redundant circuitry necessary to allow its use in personnel safety applications. A device failure or malfunction can cause either an energized (on) or de-energized (off) output condition.



Important:

- **Never operate a 1 Watt radio without connecting an antenna**
- Operating 1 Watt radios without an antenna connected will damage the radio circuitry.
- To avoid damaging the radio circuitry, never apply power to a Sure Cross® Performance or Sure Cross MultiHop (1 Watt) radio without an antenna connected.



Important:

- **Electrostatic discharge (ESD) sensitive device**
- ESD can damage the device. Damage from inappropriate handling is not covered by warranty.
- Use proper handling procedures to prevent ESD damage. Proper handling procedures include leaving devices in their anti-static packaging until ready for use; wearing anti-static wrist straps; and assembling units on a grounded, static-dissipative surface.

Models

Models	Frequency	I/O
DX80DR9M-H2	900 MHz ISM Band	Inputs: Four PNP discrete, two 0 to 20 mA analog Outputs: Four PNP discrete, two 0 to 20 mA analog
DX80DR2M-H2	2.4 GHz ISM Band	Serial interface: RS-485





DX80...C (IP20; NEMA 1) models are also available. To order this model with an IP20 housing, add a C to the end of the model number: DX80DR9M-H2C.

Configuration Instructions

Setting Up Your MultiHop Network

To set up and install your wireless MultiHop network, follow these steps:

1. If your radios have DIP switches, configure the DIP switches of all devices.
2. Connect the sensors to the MultiHop radios if applicable.
3. Apply power to all devices.
4. If your MultiHop radio has rotary dials, set the MultiHop Radio (Slave) ID. If your MultiHop radio has no rotary dials, continue to the next step.
5. Form the wireless network by binding the slave and repeater radios to the master radio. If the binding instructions are not included in this datasheet, refer to the quick start guide or product manual.
6. Observe the LED behavior to verify the devices are communicating with each other.
7. Configure any I/O points to use the sensors connected to the Sure Cross devices.
8. Conduct a site survey between the MultiHop radios. If the site survey instructions are not included in this datasheet, refer to the product manual.
9. Install your wireless sensor network components. If the installation instructions are not included in this datasheet, refer to the product manual.

For additional information, refer to one of the following documents:

- MultiHop Data Radio Quick Start Guide: [152653](#)
- MultiHop Data Radio Instruction Manual: [151317](#)
- MultiHop Register Guide: [155289](#)

Configure the DIP Switches

Before changing DIP switch positions, disconnect the power. Any changes made to the DIP switches are not recognized until after power is cycled to the device.

Access the Internal DIP Switches

Follow these steps to access the internal DIP switches.

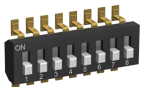

1. Unscrew the four screws that mount the cover to the bottom housing.
2. Remove the cover from the housing without damaging the ribbon cable or the pins the cable plugs into.
3. Gently unplug the ribbon cable from the board mounted into the bottom housing. For integrated battery models (no ribbon cable), C housing models (ribbon cable is glued down), and Class I, Division 2 certified devices (ribbon cable is glued down), skip this step.
4. Remove the black cover plate from the bottom of the device's cover.
The DIP switches are located behind the rotary dials.
5. Make the necessary changes to the DIP switches.
6. Place the black cover plate back into position and gently push into place.
7. If necessary, plug the ribbon cable in after verifying that the blocked hole lines up with the missing pin.
8. Mount the cover back onto the housing.

DIP Switch Settings (MultiHop)

Device Settings	Switches							
	1	2	3	4	5	6	7	8
Serial line baud rate 19200 OR User defined receiver slots	OFF ¹	OFF ¹						
Serial line baud rate 38400 OR 32 receiver slots	OFF	ON						
Serial line baud rate 9600 OR 128 receiver slots	ON	OFF						
Serial line baud rate Custom OR 4 receiver slots	ON ²	ON ²						
Parity: None			OFF ¹	OFF ¹				
Parity: Even			OFF	ON				
Parity: Odd			ON	OFF				
Disable serial (low power mode) and enable the receiver slots select for switches 1-2			ON ²	ON ²				

Device Settings	Switches							
	1	2	3	4	5	6	7	8
Transmit power 900 MHz radios: 1.00 Watt (30 dBm) 2.4 GHz radios: 0.065 Watts (18 dBm) and 60 ms frame					OFF ¹			
Transmit power 900 MHz radios: 0.25 Watts (24 dBm) 2.4 GHz radios: 0.065 Watts (18 dBm) and 40 ms frame					ON			
Application mode: Modbus						OFF ¹		
Application mode: Transparent						ON		
MultiHop radio setting: Repeater							OFF ¹	OFF ¹
MultiHop radio setting: Master							OFF	ON
MultiHop radio setting: Slave							ON ²	OFF ²
MultiHop radio setting: Reserved							ON	ON

¹ Default configuration

² Default configuration for the E housing models only

Application Mode

The MultiHop radio operates in either Modbus mode or transparent mode. Use the internal DIP switches to select the mode of operation. All MultiHop radios within a wireless network must be in the same mode.

Modbus mode uses the Modbus protocol for routing packets. In Modbus mode, a routing table is stored in each parent device to optimize the radio traffic. This allows for point to point communication in a multiple data radio network and acknowledgement/retry of radio packets. To access a radio's I/O, the radios must be running in Modbus mode.

In **transparent** application mode, all incoming packets are stored, then broadcast to all connected data radios. The data communication is packet based and not specific to any protocol. The application layer is responsible for data integrity. For one to one data radios it is possible to enable broadcast acknowledgement of the data packets to provide better throughput. In transparent mode, there is no access to the radio's I/O.

Baud Rate and Parity

The baud rate (bits per second) is the data transmission rate between the device and whatever it is physically wired to. Set the parity to match the parity of the device you are wired to.

Disable Serial

If the local serial connection is not needed, disable it to reduce the power consumption of a data radio powered from the solar assembly or from batteries. All radio communications remain operational.

Receiver Slots

The number of receiver slots indicates the number of times out of 128 slots/frames the radio can transmit to its parent radio. Setting a slave's receiver slots to 4 reduces the total power consumption by establishing that the slave can only transmit to its parent four times per 128 slots.

Transmit Power Levels/Frame Size

The 900 MHz data radios can be operated at 1 watt (30 dBm) or 0.250 watt (24 dBm). For most models, the default transmit power is 1 watt.

For 2.4 GHz radios, the transmit power is fixed at 0.065 watt (18 dBm) and DIP switch 5 is used to set the frame timing. The default position (OFF) sets the frame timing to 60 milliseconds. To increase throughput, set the frame timing to 40 milliseconds.

Prior to date code 15341 and radio firmware version 3.6, the frame timing was 40 ms (OFF) or 20 ms (ON).

Wire Your Sure Cross® Device

Use the following wiring diagrams to first wire the sensors and then apply power to the Sure Cross devices.

Wiring Power and Ground

Connecting power to the communication pins will cause permanent damage.

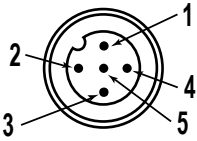
5-pin M12/Euro-style Male Connector	Pin	Wire Color	Wiring Description
	1	Brown	10 to 30 V dc
	2	White	RS-485 / D1 / B / +
	3	Blue	dc common (GND)
	4	Black	RS-485 / D0 / A / -
	5	Gray	-

Wiring for DX80...M-HxC Models for Power and Ground

Connecting power to the communication pins will cause permanent damage.

Terminal	Wiring Description
V+	10 to 30 V dc
Tx/+	RS-485 / D1 / B / +
V-	dc common (GND)

Terminal	Wiring Description
Rx/-	RS-485 / D0 / A / -
B+	-

Wiring Diagrams (IP67 Models)

Discrete Input Wiring for PNP Sensors

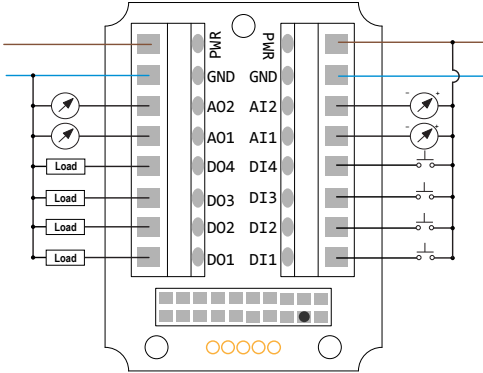

AIx or Ax. Analog IN x
 AOx. Analog OUT x
 DIx. Discrete IN x

Discrete Input Wiring for NPN Sensors

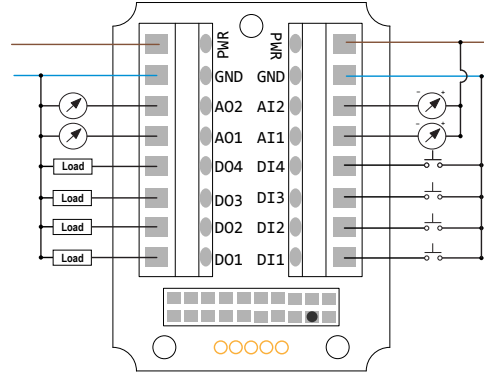

DOx. Discrete OUT x
 GND. Ground/dc common connection
 PWR. 10 to 30 V dc power connection

Wiring Diagrams (IP20 Models)

Connecting power to the communication pins will cause permanent damage. Refer to the Class I Division 2/Zone 2 control drawings (p/n 143086) for wiring specifications and limitations.

PNP Discrete Inputs

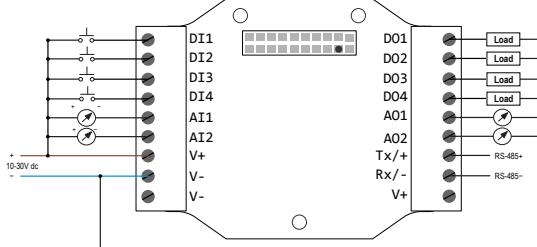

AIx or Ax. Analog IN x
 AOx. Analog OUT x
 DIx. Discrete IN x
 DIx. Discrete IN x
 DOx. Discrete OUT x
 GND. Ground/dc common connection

NPN Discrete Inputs

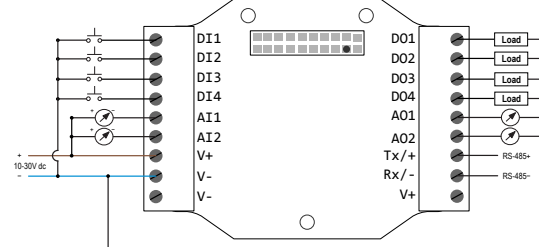

PWR. 10 to 30 V dc power connection
 RX/-. Serial communication line for the Gateway. No connection for Nodes
 TX/+. Serial communication line for the Gateway; no connection for Nodes
 V+. 10 to 30 V dc power connection
 V-. Ground/dc common connection

Set the MultiHop Radio (Slave) ID

On a MultiHop radio, use the rotary dials to set the device's MultiHop Radio ID.

Modbus Slave IDs 01 through 10 are reserved for slaves directly connected to the host (local I/O). Polling messages addressed to these devices are not relayed over the wireless link. Use Modbus Slave IDs 11 through 60 for MultiHop master, repeater, and slave radios. Up to 50 devices (local slaves and remote slaves) may be used in this system.

With the left dial acting as the left digit and the right dial acting as the right digit, the MultiHop Radio ID can be set from 01 through 60.



MultiHop Configuration Software

Use Banner's MultiHop Configuration Software to view your MultiHop radio network and configure the radio and its I/O.

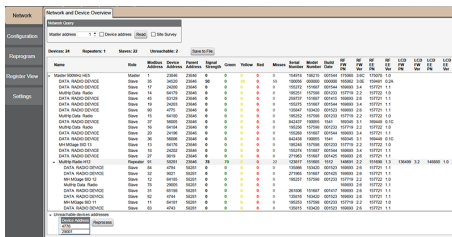

The software connects to a MultiHop master radio using one of four methods.

- Serial; using a USB to RS-485 (for RS-485 radios) or a USB to RS-232 (for RS-232 radios) converter cable.
- Modbus TCP; using an Ethernet connection to an Ethernet radio master.
- Serial DXM; using a USB cable to a DXM Controller to access a MultiHop master radio.
- TCP DXM: using an Ethernet connection to a DXM Controller to access a MultiHop master radio.

For MultiHop DX80DR* models, Banner recommends using BWA-UCT-900, an RS-485 to USB adapter cable with a wall plug that can power your 1 Watt MultiHop radio while you configure it. The adapter cable is not required when connecting to a DXM Controller.

Download the most recent software revision from the Wireless Reference Library on Banner Engineering's website: www.bannerengineering.com.

Installing Your Sure Cross® Radios

Please refer to one of the following instruction manuals for details about successfully installing your wireless network components.

- MultiHop Data Radio Instruction Manual: [151317](#)

Modbus Registers

Register (4xxxx)	Input #	I/O Type	I/O Range		Holding Register Representation		Terminal
			Min. Value	Max. Value	Min. (Dec.)	Max. (Dec.)	
1	1	Discrete IN 1	0	1	0	1	DI1
2	2	Discrete IN 2	0	1	0	1	DI2
3	3	Discrete IN 3	0	1	0	1	DI3
4	4	Discrete IN 4	0	1	0	1	DI4
5	5	Analog IN 1 (mA)	0.0	20.0	0	65535	AI1
6	6	Analog IN 2 (mA)	0.0	20.0	0	65535	AI2

Register (4xxxx)	Output #	I/O Type	I/O Range		Holding Register Representation		Terminal
			Min. Value	Max. Value	Min. (Dec.)	Max. (Dec.)	
501	1	Discrete OUT 1	0	1	0	1	DO1
502	2	Discrete OUT 2	0	1	0	1	DO2
503	3	Discrete OUT 3	0	1	0	1	DO3
504	4	Discrete OUT 4	0	1	0	1	DO4
505	5	Analog OUT 1 (mA)	0.0	20.0	0	65535	AO1
506	6	Analog OUT 2 (mA)	0.0	20.0	0	65535	AO2

Modbus Addressing Convention

All Modbus addresses refer to Modbus holding registers. When writing your own Modbus scripts, use the appropriate commands for interfacing to holding registers. Parameter description headings refer to addresses in the range of 40000 as is customary with Modbus convention.

Modbus Register Configuration

Change the factory default settings for the inputs, outputs, and device operations using the device Modbus registers. To change parameters, set the data radio network to Modbus mode and assign the data radio a valid Modbus slave ID.

Generic input or output parameters are grouped together based on the device input or output number: input 1, input 2, output 1 etc. Operation type specific parameters (discrete, counter, analog 4 to 20 mA) are grouped together based on the I/O type number: analog 1, analog 2, counter 1, etc. Not all inputs or outputs may be available for all models. To determine which specific I/O is available on your model, refer to the Modbus Input/Output Register Maps listed in the device's datasheet. For more information about registers, refer to the MultiHop Product Manual (p/n [151317](#)).

Factory Default Configuration

Discrete Inputs (PNP)

Enable	Sample	Boost Enable	Boost Warmup	Boost Voltage	Extended Input Read	NPN/PNP	Sample High	Sample Low
ON	40 ms	OFF	OFF	OFF	OFF	PNP	OFF	OFF

Analog Inputs

Enable	Sample	Boost Enable	Boost Warmup	Boost Voltage	Extended Input Read	Analog Max	Analog Min	Enable Fullscale
ON	1 sec	OFF	OFF	OFF	OFF	20000	0	ON

Discrete Outputs

Enable	Flash Enable
ON	OFF

Analog Outputs

Enable	Analog Max	Analog Min	Enable Fullscale	Hold Last State Enable	Default Output State
ON	20000	0	ON	OFF	0

Specifications

MultiHop Radio Specifications

Radio Range¹

900 MHz, 1 Watt: Up to 9.6 km (6 miles)
2.4 GHz, 65 mW: Up to 3.2 km (2 miles)

Antenna Minimum Separation Distance

900 MHz, 150 mW and 250 mW: 2 m (6 ft)
900 MHz, 1 Watt: 4.57 m (15 ft)
2.4 GHz, 65 mW: 0.3 m (1 ft)

Radio Transmit Power

900 MHz, 1 Watt: 30 dBm (1 W) conducted (up to 36 dBm EIRP)
2.4 GHz, 65 mW: 18 dBm (65 mW) conducted, less than or equal to 20 dBm (100 mW) EIRP

Spread Spectrum Technology

FHSS (Frequency Hopping Spread Spectrum)

900 MHz Compliance (1 Watt)

FCC ID UE3RM1809: FCC Part 15, Subpart C, 15.247
IC: 7044A-RM1809

2.4 GHz Compliance (MultiHop)

FCC ID UE300DX80-2400: FCC Part 15, Subpart C, 15.247
RED Directive 2014/53/EU
IC: 7044A-DX8024

Antenna Connection

Ext. Reverse Polarity SMA, 50 Ohms
Max Tightening Torque: 0.45 N-m (4 lbf-in)

Radio Packet Size (MultiHop)

900 MHz: 175 bytes (85 Modbus registers)
2.4 GHz: 75 bytes (37 Modbus registers)

RS-485 Communication Specifications

Communication Hardware (MultiHop RS-485)

Interface: 2-wire half-duplex RS-485
Baud rates: 9.6k, 19.2k (default), or 38.4k via DIP switches; 1200 and 2400 via the MultiHop Configuration Software
Data format: 8 data bits, no parity, 1 stop bit

H2 Specifications

Supply Voltage

10 V DC to 30 V DC (Outside the USA: 12 V DC to 24 V DC, $\pm 10\%$)²

Power Consumption

Master radio consumption (900 MHz): Maximum current draw is < 100 mA and typical current draw is < 30 mA at 24 V DC. (2.4 GHz consumption is less.)
Repeater/slave radio consumption (900 MHz): Maximum current draw is < 40 mA and typical current draw is < 20 mA at 24 V DC. (2.4 GHz consumption is less.)

Discrete Inputs

Rating: 3 mA max current at 30 V DC
Sample Rate: 40 milliseconds

Discrete Input ON Condition

PNP: Greater than 8 V
NPN: Less than 0.7 V

Discrete Input OFF Condition

PNP: Less than 5 V
NPN: Greater than 2 V or open

Analog Inputs

Rating: 24 mA
Impedance: Approximately 100 Ohms (To verify the analog input's impedance, use an Ohm meter to measure the resistance between the analog input terminal (AIx) and the ground (GND) terminal.)
Sample Rate: 1 second
Accuracy: 0.1% of full scale +0.01% per °C
Resolution: 12-bit

Housing

Polycarbonate housing and rotary dial cover; polyester labels; EDPM rubber cover gasket; nitrile rubber, non-sulphur cured button covers
Weight: 0.26 kg (0.57 lbs)
Mounting: #10 or M5 (SS M5 hardware included)
Max. Tightening Torque: 0.56 N-m (5 lbf-in)

Interface

Two bi-color LED indicators, Two buttons, Six character LCD

Wiring Access

M-Hx models: Four PG-7, One 1/2-inch NPT, One 5-pin threaded M12/Euro-style male quick disconnect
M-HxC models: External terminals

Discrete Outputs

Update Rate: 125 milliseconds
ON Condition: Supply minus 2 V
OFF Condition: Less than 2 V
Output State Following Timeout: OFF

Discrete Output Rating (PNP)

100 mA max current at 30 V DC
ON-State Saturation: Less than 3 V at 100 mA
OFF-state Leakage: Less than 10 μ A

Analog Outputs

Update Rate: 125 milliseconds
Accuracy: 0.1% of full scale +0.01% per °C
Resolution: 12-bit

¹ Radio range is with the 2 dB antenna that ships with the product. High-gain antennas are available, but the range depends on the environment and line of sight. Always verify your wireless network's range by performing a Site Survey.

² For European applications, power this device from a Limited Power Source as defined in EN 60950-1.

Certifications for DX8x...C (External Wiring Terminal) and DX8x...E Models



CSA: Class I Division 2 Groups ABCD, Class I Zone 2 AEx/Ex nA II T4 — Certificate: 1921239



ATEX: II 3 G Ex nA IIC T4 Gc (Group IIC Zone 2) — Certificate LCIE 10 ATEX 1012 X

Refer to the Class I Division 2/Zone 2 control drawings (p/n 143086) for wiring specifications and limitations. Install the device in a suitable enclosure with provision for connection of Division 2 / Zone 2 wiring methods in accordance with local codes, as acceptable to the local inspection authority having jurisdiction. All battery-powered devices must only use the lithium battery manufactured by Xeno, model XL-205F (Banner model number BWA-BATT-001).

Certifications



(CE approval only applies to 2.4 GHz models)



(NOM approval only applies to 900 MHz models)



Required Overcurrent Protection



WARNING: Electrical connections must be made by qualified personnel in accordance with local and national electrical codes and regulations.

Overcurrent protection is required to be provided by end product application per the supplied table. Overcurrent protection may be provided with external fusing or via Current Limiting, Class 2 Power Supply. Supply wiring leads < 24 AWG shall not be spliced. For additional product support, go to www.bannerengineering.com.

Supply Wiring (AWG)	Required Overcurrent Protection (Amps)
20	5.0
22	3.0
24	2.0
26	1.0
28	0.8
30	0.5

Environmental Specifications

Operating Conditions

-40 °C to +85 °C (-40 °F to +185 °F) (Electronics); -20 °C to +80 °C (-4 °F to +176 °F) (LCD)
95% maximum relative humidity (non-condensing)
Radiated Immunity: 10 V/m (EN 61000-4-3)

Shock and Vibration

IEC 68-2-6 and IEC 68-2-27
Shock: 30g, 11 millisecond half sine wave, 18 shocks
Vibration: 0.5 mm p-p, 10 to 60 Hz

Environmental Ratings

IEC IP67; NEMA 6
Refer to the Sure Cross® MultiHop Product Instruction Manual (p/n 151317) for installation and waterproofing instructions.

Operating the devices at the maximum operating conditions for extended periods can shorten the life of the device.

Environmental Specifications for the C Housings

Operating Conditions

-40 °C to +85 °C (-40 °F to +185 °F) (Electronics); -20 °C to +80 °C (-4 °F to +176 °F) (LCD)
95% maximum relative humidity (non-condensing)
Radiated Immunity: 10 V/m (EN 61000-4-3)

Shock and Vibration

IEC 68-2-6 and IEC 68-2-27
Shock: 30g, 11 millisecond half sine wave, 18 shocks
Vibration: 0.5 mm p-p, 10 to 60 Hz

Environmental Ratings

"C" Housing Models/External wiring terminals: IEC IP20; NEMA 1
Refer to the Sure Cross® Wireless I/O Networks Instruction Manual (p/n 132607) for installation and waterproofing instructions.

Operating the devices at the maximum operating conditions for extended periods can shorten the life of the device.

Included with the DX80 and DX80...C Models

- BWA-HW-002: DX80 Access Hardware Kit, containing four PG-7 plastic threaded plugs, four PG-7 nylon gland fittings, four PG-7 hex nuts, one 1/2-inch NPT plug, and one 1/2-inch nylon gland fitting. (Not included with IP20 DX80...C models)
- BWA-HW-001: Mounting Hardware Kit, containing four M5-0.8 x 25mm SS screws, four M5-0.8 x 16mm SS screws, four M5-0.8mm SS hex nuts, and four #8-32 x 3/4" SS bolts
- BWA-HW-003: PTFE tape
- BWA-9O2-C (900 MHz) or BWA-2O2-C (2.4 GHz): Antenna, 2 dBd Omni, Rubber Swivel RP-SMA Male. (Not included with Internal antenna models)
- MQDC1-506: 5-Euro (single ended) straight cable, 2m (Not included with FlexPower devices)
- BWA-HW-011: IP20 Screw Terminal Headers (2 pack) (Included only with the IP20 DX80...C models)
- Product datasheet and product family Quick Start Guide (128185 for DX80 Gateways or 152653 for MultiHop models)

Warnings

Install and properly ground a qualified surge suppressor when installing a remote antenna system. Remote antenna configurations installed without surge suppressors invalidate the manufacturer's warranty. Keep the ground wire as short as possible and make all ground connections to a single-point ground system to ensure no ground loops are created. No surge suppressor can absorb all lightning strikes; do not touch the Sure Cross® device or any equipment connected to the Sure Cross device during a thunderstorm.

Exporting Sure Cross® Radios. It is our intent to fully comply with all national and regional regulations regarding radio frequency emissions. **Customers who want to re-export this product to a country other than that to which it was sold must ensure the device is approved in the destination country.** The Sure Cross wireless products were certified for use in these countries using the antenna that ships with the product. When using other antennas, verify you are not exceeding the transmit power levels allowed by local governing agencies. This device has been designed to operate with the antennas listed on Banner Engineering's website and having a maximum gain of 9 dBm. Antennas not included in this list or having a gain greater than 9 dBm are strictly prohibited for use with this device. The required antenna impedance is 50 ohms. To reduce potential radio interference to other users, the antenna type and its gain should be so chosen such that the equivalent isotropically radiated power (EIRP) is not more than that permitted for successful communication. Consult with Banner Engineering Corp. if the destination country is not on this list.

Banner Engineering Corp. Limited Warranty

Banner Engineering Corp. warrants its products to be free from defects in material and workmanship for one year following the date of shipment. Banner Engineering Corp. will repair or replace, free of charge, any product of its manufacture which, at the time it is returned to the factory, is found to have been defective during the warranty period. This warranty does not cover damage or liability for misuse, abuse, or the improper application or installation of the Banner product.

THIS LIMITED WARRANTY IS EXCLUSIVE AND IN LIEU OF ALL OTHER WARRANTIES WHETHER EXPRESS OR IMPLIED (INCLUDING, WITHOUT LIMITATION, ANY WARRANTY OF MERCHANTABILITY OR FITNESS FOR A PARTICULAR PURPOSE), AND WHETHER ARISING UNDER COURSE OF PERFORMANCE, COURSE OF DEALING OR TRADE USAGE.

This Warranty is exclusive and limited to repair or, at the discretion of Banner Engineering Corp., replacement. **IN NO EVENT SHALL BANNER ENGINEERING CORP. BE LIABLE TO BUYER OR ANY OTHER PERSON OR ENTITY FOR ANY EXTRA COSTS, EXPENSES, LOSSES, LOSS OF PROFITS, OR ANY INCIDENTAL, CONSEQUENTIAL OR SPECIAL DAMAGES RESULTING FROM ANY PRODUCT DEFECT OR FROM THE USE OR INABILITY TO USE THE PRODUCT, WHETHER ARISING IN CONTRACT OR WARRANTY, STATUTE, TORT, STRICT LIABILITY, NEGLIGENCE, OR OTHERWISE.**

Banner Engineering Corp. reserves the right to change, modify or improve the design of the product without assuming any obligations or liabilities relating to any product previously manufactured by Banner Engineering Corp. Any misuse, abuse, or improper application or installation of this product or use of the product for personal protection applications when the product is identified as not intended for such purposes will void the product warranty. Any modifications to this product without prior express approval by Banner Engineering Corp will void the product warranties. All specifications published in this document are subject to change; Banner reserves the right to modify product specifications or update documentation at any time. Specifications and product information in English supersede that which is provided in any other language. For the most recent version of any documentation, refer to: www.bannerengineering.com.

For patent information, see www.bannerengineering.com/patents.

Notas Adicionales

Información México: La operación de este equipo está sujeta a las siguientes dos condiciones: 1) es posible que este equipo o dispositivo no cause interferencia perjudicial y 2) este equipo debe aceptar cualquier interferencia, incluyendo la que pueda causar su operación no deseada.

Banner es una marca registrada de Banner Engineering Corp. y podrán ser utilizadas de manera indistinta para referirse al fabricante. "Este equipo ha sido diseñado para operar con las antenas tipo Omnidireccional para una ganancia máxima de antena de 6 dBd y Yagi para una ganancia máxima de antena 10 dBd que en seguida se enlistan. También se incluyen aquellas con aprobación ATEX tipo Omnidireccional siempre que no excedan una ganancia máxima de antena de 6dBd. El uso con este equipo de antenas no incluidas en esta lista o que tengan una ganancia mayor que 6 dBd en tipo omnidireccional y 10 dBd en tipo Yagi, quedan prohibidas. La impedancia requerida de la antena es de 50 ohms."

Antenas SMA	Modelo	Antenas Tipo-N	Modelo
Antena, Omni 902-928 MHz, 2 dBd, junta de caucho, RP-SMA Macho	BWA-902-C	Antena, Omni 902-928 MHz, 6 dBd, fibra de vidrio, 1800mm, N Hembra	BWA-906-A
Antena, Omni 902-928 MHz, 5 dBd, junta de caucho, RP-SMA Macho	BWA-905-C	Antena, Yagi, 900 MHz, 10 dBd, N Hembra	BWA-9Y10-A

Mexican Importer

Banner Engineering de México, S. de R.L. de C.V.
David Alfaro Siqueiros 103 Piso 2 Valle oriente
San Pedro Garza Garcia Nuevo Leon, C. P. 66269

81 8363.2714