

# Part No. 9001118

## V2X Ceramic Patch Antenna

### 5.9 GHz DSRC Band

Supports: V2V/V2I/V2P Applications, Automotive, Vehicle Safety Applications, Intelligent Transportation System



### V2X Ceramic Patch Antenna

US – Band 5850 – 5925 MHz  
EU – Band 5870 – 5905 MHz

#### KEY BENEFITS

##### Reduced Costs and Time-to-Market

Standard antenna eliminates design fees and cycle time associated with a custom solution; getting products to market faster.

##### Greater Flexibility with Unique Form Factors

Ethertronics' technology helps you deliver more advanced ergonomic designs without adverse impact on product performance.

##### RoHS Compliant

Products are the latest RoHS version compliant.

#### APPLICATIONS

- Vehicle Safety Applications
- Automotive
- Connected car application
- safety driving support
- Embedded system

Ethertronics family of ceramic patch antennas are designed to offer the best performances for a wide range of applications. The 9001118 antenna is specifically designed for Dedicated Short Range Communication systems. This high performance antenna is perfect for V2X applications to provide the high-secure and high-speed wireless communication between vehicle and Infrastructure

#### Global Operations & Design Support

Ethertronics' global operations support an integrated network of design centers that can take projects from concept to production.

#### Electrical Specifications

Typical performance measured with 70 x 70 mm PCB

Frequency (GHZ)	5.850 – 5.925
Gain 0° xz plane	4 dB
Average Efficiency	55 %
Return Loss	< -15 dB
Polarization	R.H.C.P
Impedance	50 ohm

#### Mechanical Specifications & Ordering Part Number

Ordering Part Number	9001118
Dimensions (mm)	13.00 ± 0.20 length 13.00 ± 0.20 width 4.00± 0.20 thickness
Mounting	Adhesive 3M (11x11x0.05) 1 trough-hole Soldered Pin
Weight (grams)	12
Operating Temperature (°C )	-40 to +70



### 5.9 GHz DSRC Ceramic Patch Antenna Specifications

Ethertronics produces a wide variety of standard and custom antennas to meet user needs

#### Return Loss, Efficiency, Peak Gain and RHCP Gain Plots

Typical performance measured with 70 x 70 mm PCB

#### Return Loss

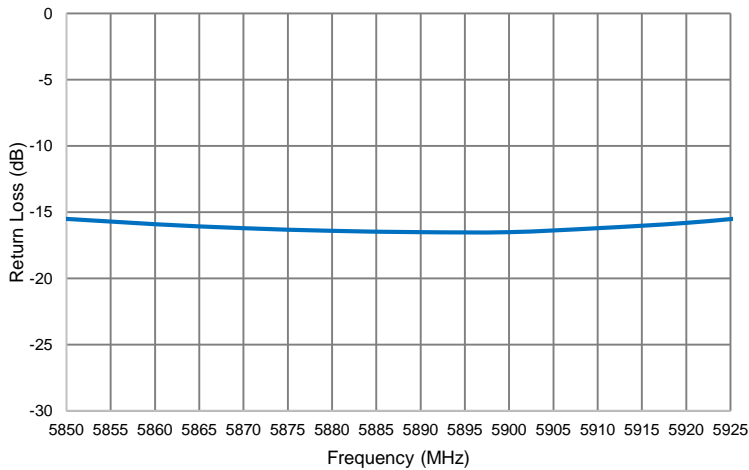

#### Efficiency

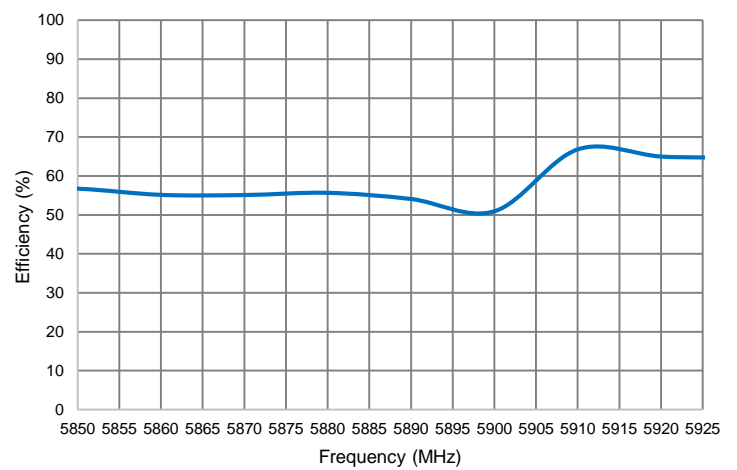

#### RHCP Gain Phi = 90 deg YZ Plane

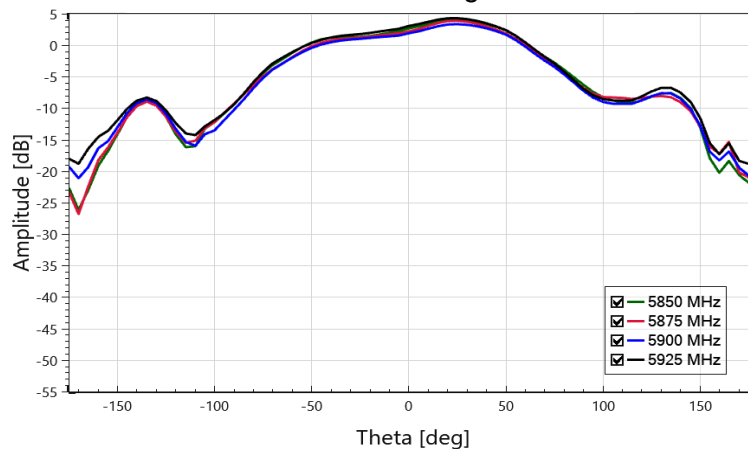

#### RHCP Gain Phi = 0 deg XZ Plane

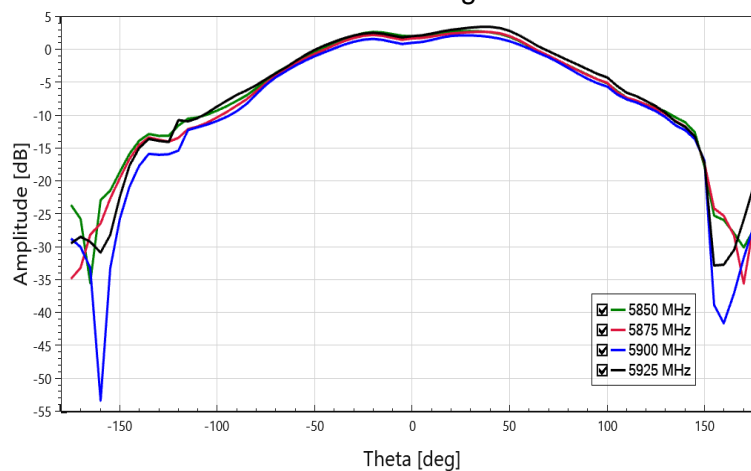



**5.9 GHz DSRC Ceramic Patch Antenna Specifications**

Ethertronics produces a wide variety of standard and custom antennas to meet user needs

**Antenna Radiation Patterns and Axial Ratio**

Typical performance measured with 70 x 70 mm PCB  
Measured at 5870

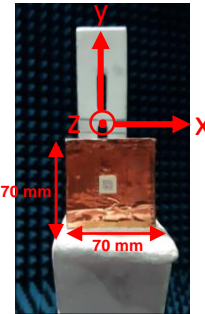
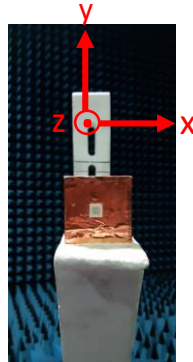

Measured at 5870 MHz

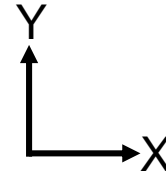
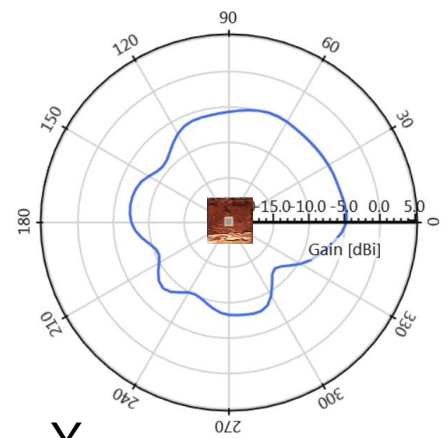
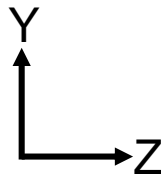
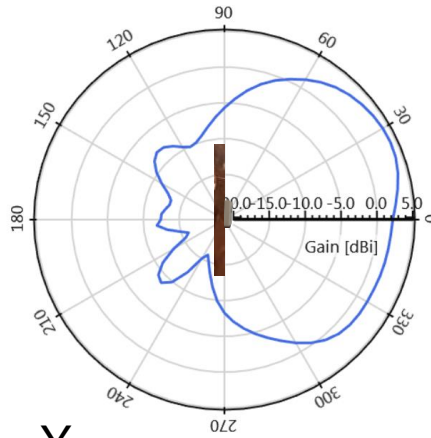
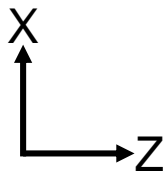
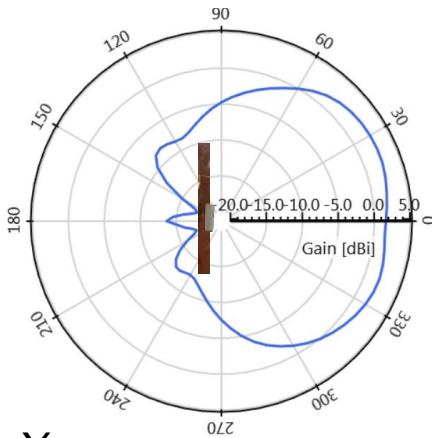

Phi=90°

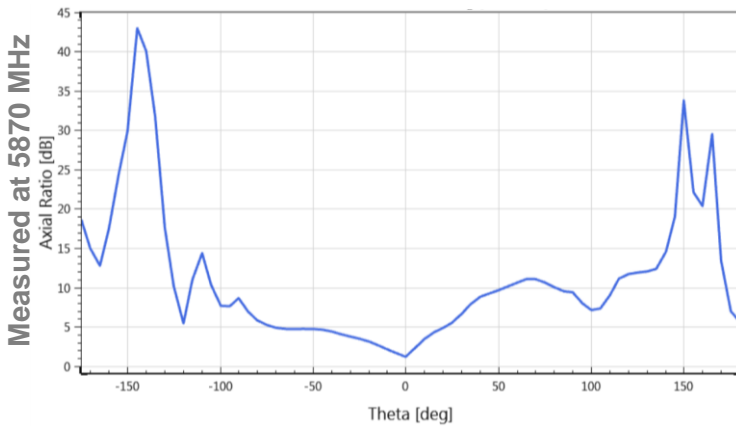

Phi=0°





5.9 GHz DSRC Ceramic Patch Antenna Specifications

Ethertronics produces a wide variety of standard and custom antennas to meet user needs

Mechanical Dimensions

Typical antenna dimensions (mm)

Part Number	A (mm)	B (mm)	C(mm)	Ø1 (mm)	D (mm)	E(mm)	F (mm)	Ø2 (mm)
9001118	13.00 ± 0.20	13.00 ± 0.20	4.00 ± 0.20	1.42 ± 0.10	0.81 ± 0.03	3.00 ± 0.30	1.30 ± 0.10	2.80 ± 0.20

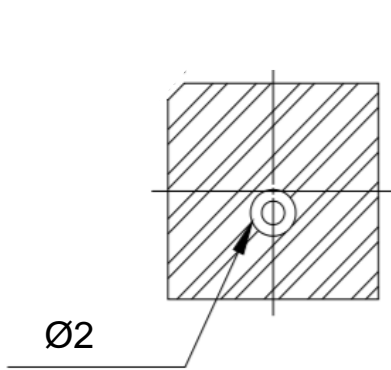

Bottom -View-

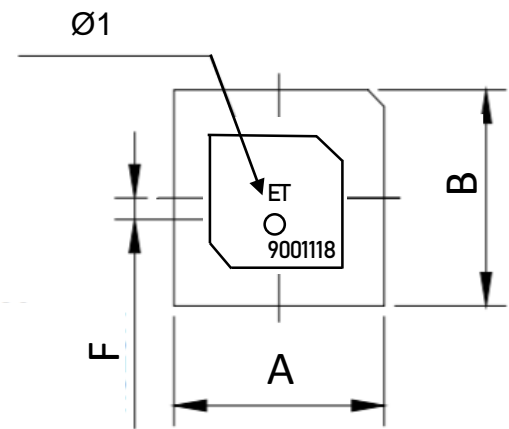
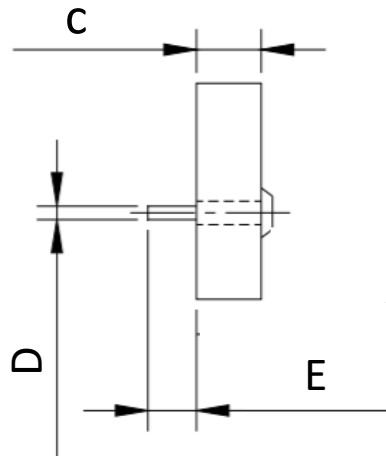

Top -View-