



Compact Home  
Protection and comfort systems  
for your home



# Compact Home

## ABB system for your home

[Introduction](#)

1

[Protection](#)

2

[Command and alerts](#)

3

[Comfort](#)

4

[Energy efficiency](#)

5

[Consumer units and junction boxes](#)

6





# Introduction

Safety at home with ABB	1/2
A technology that isn't to see, but is to live	1/4

## Applications and solutions

Smart protection for lasting comfort	1/6
Expertise that lets you think big	1/8
Greater comfort, full protection	1/10

An offering designed to meet present and future needs	1/12
Efficiency, protection, comfort: measuring a system's value	1/14
Application examples	1/20

# Safety at home with ABB

1

Thanks to its expertise, ABB offers the best solutions and most effective products for your home. A comprehensive fully integrated range of highly reliable, easy-to-install products.

By definition, the home is where you find maximum comfort and protection.

Comfort and protection are closely linked. They are linked to factors such as personal safety, energy savings, environmental sustainability, economic advantage.

Nowadays, new buildings are based on higher building

standards and regulations: state-of-the-art materials and products are designed, installed and operated to ensure once unimaginable levels of well-being and safety. Within this rapid evolution, plants - whether electric, thermo-hydraulic, data transmission or any other kind - are the nerves and intelligence of all buildings. They allow us to manage

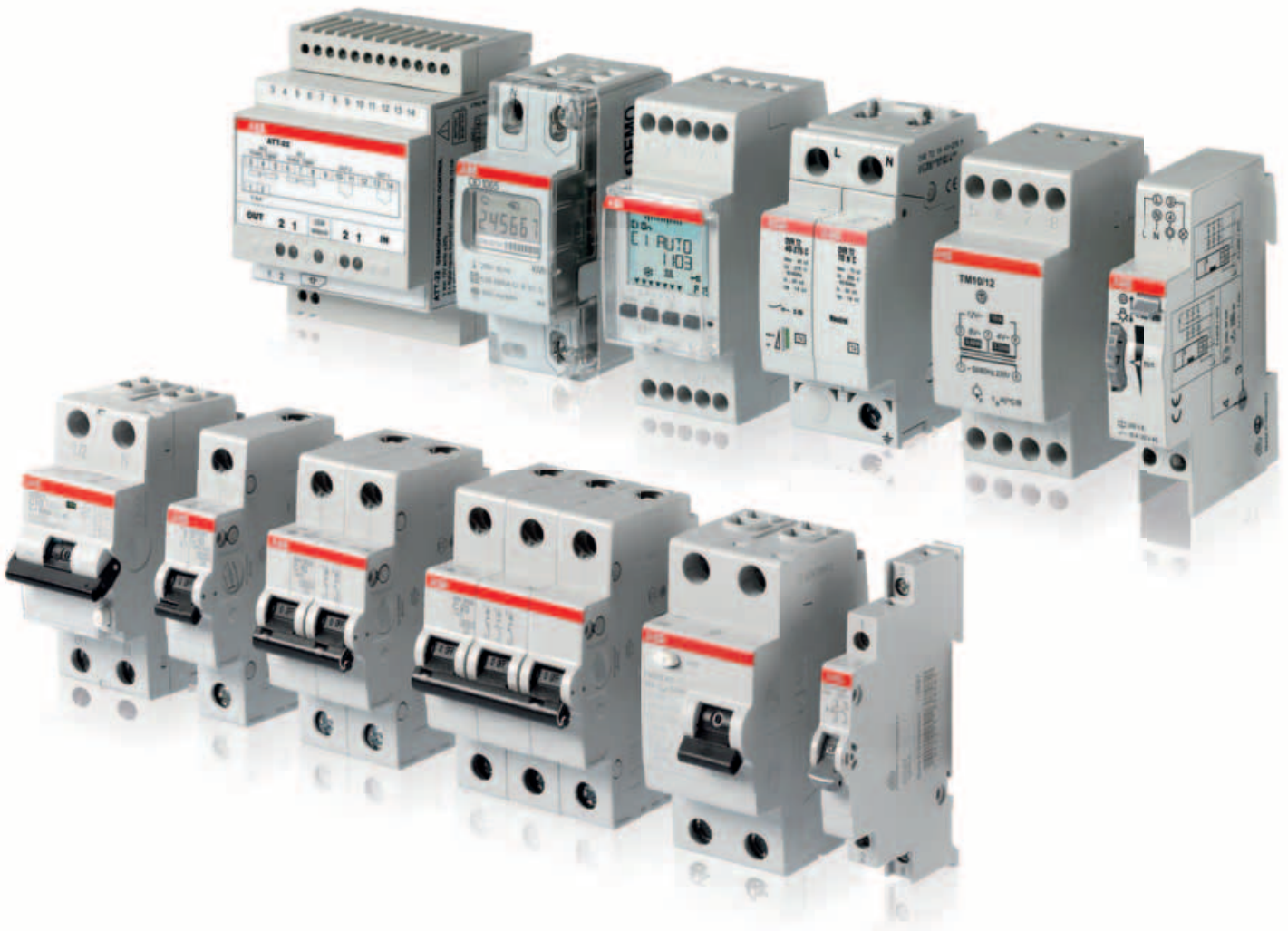

and optimise our use of energy, climate, sound, alarms, communications and to synchronise any device - electric, electronic, mechanical, hydraulic - based on time of day, use conditions and user expectations.

Through its Compact Home range, ABB makes a full product range available to residential building plant designers and installers. Reliable, easy to use, based on advanced technology these products were born of the research and know how of one of the world's greatest industrial leaders. Today ABB offers all the products, systems and services needed to guarantee maximum domestic comfort and protection, in any environment or context.

The Compact Home range includes devices and equipment used to reliably manage utilities: these solutions enable

you to optimise, integrate and make safety, protection and comfort systems inside and outside your home more efficient, from kitchen to bathroom, lounge to bedroom, garage to garden. Range integration and modularity are two of the basic concepts of ABB's Compact Home . All Compact Home products are versatile and can easily be completed and enriched by other solutions chosen from the vast ABB solution portfolio.

Devices installed in the control panel or switchboard are flanked by Compact Home range control and automation solutions based on the most modern aesthetic and design concepts, but also provided with analogical and digital functions and bus or wireless communications.



# A technology that isn't to see, but is to live

1

The endless personalization and integration possibilities of ABB residential solutions allow you to tailor systems to your exact requirements, combining protection, safety, comfort and savings.

## Protection

Protecting means safeguarding users, environments and equipment against risks and damage linked to bad use conditions or breakdown. Surge, overloads, short circuits or earth leakage currents are danger situations which, with no adequate control, can damage the plant and lead to bad accidents like fulmination, fire, flooding or explosion. Miniature circuit breakers (MCBs), residual current devices (RCDs) and the other protection products in Compact Home catalogue allow you to make installations and equipment safer, offering users the certainty that their plants always satisfy parameters established by the most binding international standards.

## Safety

Making one's personal, domestic environment safe and inviolable has always been one of our most important needs. ABB offers a number of safety solutions guaranteeing control over the surrounding environment to avoid intrusion and dangerous situations. Its ample catalogue includes integrated anti-intrusion, video control, video entry-phones and building automation systems. Reliable, flexible and affordable, these products come in both the bus and wireless versions and allow you to control and interact with your environment, locally or from a distance, by mobile phone or through internet. These systems are flanked by effective controls and modular alarms on DIN Rails, installable in any ABB switchboard or small control panel.



### Comfort

A person normally spends most of his/her time at home and it is there that the user expects greater comfort and well-being. Modern technologies have all the necessary features to make home welcoming, highly functional and advantageous economically.

ABB's Compact Home products make the different plant components functionally adaptable to the user's wellness needs. These products actively and dynamically regulate climate and lighting, but also irrigation and the many other functions needed to obtain those high comfort levels and an intelligent use of energy.

### Savings

The increased cost of energy and growing sensitivity over the environment have stimulated the user to pay greater attention to energy and its efficiency.

Even at home, those small daily gestures -like using the cheapest tariff brackets appropriately - can have a fundamental impact on both your home budget and a more rational use of our planet's resources.

The ABB Compact Home catalogue offers several products with innovative functions, with efficiency and energy savings as their main target.





# Smart protection for lasting comfort

## Applications for an apartment

1



### 1. Protection of the stove and other kitchen equipment

There are many situations, in which a short-circuit can occur, e.g. bad insulation of kitchen equipment and connection to water. Without suitable cable protection, not only the connection cable of the kitchen equipment would become charred, but also the cable installed in the wall behind the socket outlet. In worst case also hazard for human beings exists. ABB MCBs protect you and your installation in the best way – easy and safe installation is possible.



### 2. Separately protection of media and TV circuits

In newer installations, TV and media circuits are protected separately. Due to the electronics used in this kind of loads they could inject harmonics into the system and maybe it interferes with other electrical equipment. MCBs provide the best protection in cases of overload and short-circuit. ABB MCBs protect you and your installation in the best way – easy and safe installation is possible.



### 3. Main residual current protection.

In order to ensure safety and continuity of service, ABB offers selective type RCCB F200 S solution to perform selectivity with the RCDs protecting terminal circuits.



### 4. Protection of the bathroom circuit.

Thanks to the availability of 10mA DS201 RCBOs, it's possible to ensure maximum safety also in critical rooms like the bathroom where the earth leakage effects on the human body are more dangerous due to the presence of water.



### 5. Surge protection

Compact and easy to install, the DIN Rail OVR Type 2 range gives high overvoltage protection to your sensible equipment and to your apartment.



### 6. Prevention of overloads

Load management device LSS1/2 prevents overtaking a preset power consumption threshold. Two embedded relays 16A disconnect non priority loads for some minutes in case of overload, then will switch them on again automatically. Current threshold is programmable between 5A and 90A.



### 7. Safety for auxiliary circuits

Door entry and bathroom safety pushbuttons should always be supplied in SELV (safety extra low voltage) for safety reasons. TS transformers supply these auxiliary circuits; in case of short circuit TS are made to disconnect automatically the secondary winding and restore their feature automatically as soon as fault is repaired.



### 8. Bioarchitecture made real

E235 mains disconnection switch ensures no electricity in wiring accessories and electric devices on bedroom circuits when sleeping. Of course as soon as user switches on a load, electricity immediately flows again to supply it.



### 9. Object metering

Heating and ventilation pumps are obvious candidates for object metering in the home. Also electronic equipments such as washing machines and dishwashers are possible objects to measure.



### 10. UK500 – Heart of your home

In order to fulfill not only technical, but also aesthetic requirements, the UK500 combines technology and design, while offering the highest possible quality down to the smallest detail. The UK500 is an aesthetic consumer unit which harmoniously fits in its living environment.



# Expertise that lets you think big

## Residential applications

1



### 1. Common lighting circuits protection

In newer installations, lighting circuits are always protected separately from socket outlet circuits. Therefore, it is almost impossible for a danger to occur in lighting circuits in the home sector today, as the permanently connected consumers (lights and lamps) only permit their load-dependent current.

However, cable protection must be provided to prevent overloading of the cable by short-circuits.



### 2. Common socket outlet protection

MCBs provide the best protection in cases of overload and short-circuit. For sure, you can also disconnect your circuits with MCBs if you need to make maintenance work. There is a limit to the current carrying capacity for all cables! It's not important whether the short-circuit is caused by a defect common appliance or whether a nail pounded into the wall hits the cable. In addition, similar consequences can result when too many appliances are connected to a circuit at the same time (e.g. several fan heaters) to one and the same circuit via a multiple socket-outlet (overload protection).



### 3. Residual current protection in the common areas.

The FH200 RCCB range up to 63A offers the solution for the protection against insulation fault of any kind of common circuits like the staircase, outside and garage lights, porter's lodge, automated gate and all the common sockets.



### 4. Protection of the refrigerator

With the new RCBO DS201 APR, specifically designed against nuisance tripping, you can achieve a dedicated protection for the line of the refrigerator preventing goods decay due the lack of supply.



### 5. Gate management

Thanks to ATT GSM module, all housemasters can open building gate with their mobile by just dialing a number. ATT recognises authorized users avoiding the use of hundreds of expensive and unsafe gate remote controls.



### 6. Surge protection

The modular autoprotected OVR PLUS range define a new standards in surge protection.

Compact, the integrated backup protection with MCB allows a very easy installation for a better protection of your equipment. The complete OVR range is the solution to bring your house a full and safe surge protection.



### 7. Staircase lighting

E232 staircase light switches allow to switch on staircase lights only when needed, as user pushes a button. This way users can avoid energy waste, while ensuring full light availability when walking on stairways. E232 can be forced permanently on for staircase cleaning and maintenance purposes.



### 8. Joint residential sourcing

Unlike applications where a separate billing meter is installed in every apartment or residence for individual billing, joint residential sourcing involves having one central 'billing' meter. The housing association, condominium or equivalent then acts as a single electricity subscriber and redistributes its costs amongst its members according to their actual consumption measured by a meter in each apartment.



### 9. An attractive enclosure that can be discreetly integrated into your interior

The Unibox consumer units are distinguished by an advanced and elegant design. They integrate themselves easily in whichever decoration solution; for the door, it is possible to choose between the transparent smoked version and the opaque white version. Functionality of the Unibox Series and its safety of installation and safety of use guarantee high quality of construction characteristics.







# Greater comfort, full protection

## Applications for the detached house

1



### 1. Protection of the entry phone line and other telecommunication systems

In this kind of application normally different voltage level and/or different frequencies are used. To ensure the correct working of these circuits, cable protection must be provided to prevent overloading of the cable. There is a limit to the current carrying capacity for all cables! ABB MCBs protect you and your installation in the best way – easy and safe installation is possible. Make your choice.



### 2. Protection of security systems, bell circuits or electrical shutters

To ensure the correct working of these auxiliary circuits with maybe different voltage-level cable protection must be provided to prevent overloading of the cable by short-circuits or even an overload e.g. due to obstruction of the shutter. Without suitable cable protection the cable installed in the wall behind the loads becomes charred and maybe needs to be replaced or even the devices get damaged.



### 3. Sauna and swimming pool residual current protection.

To ensure continuity of service and avoid nuisance tripping due to the natural earth leakage currents that are common in a wet environment, it's a best practice to protect individually the sauna and the swimming pool circuits with a dedicated DS201 RCBO for each line.



### 4. Mains disconnection

E200 switch disconnecter is installed upstream whole electric distribution system ensuring and it is suitable for commanding loads.



### 5. Automation of basic functions

Time switch D2 with two changeover contacts controls external two zones watering system. Another digital time switch D2 controls some internal light circuits, enabling housemaster to simulate people presence even when nobody is in, thanks to random program.



### 6. External lighting only when needed

With twilight switch TW external lighting switches on automatically when getting dark, thanks to external light detection sensor. Threshold can be programmed on a wide lux range ensuring both optimal lighting and energy efficiency.



### 7. Safety of outdoor circuits

Care should always taken on outdoor lighting. Especially when close to pools or fountains, a safety extra low voltage transformer TS-C can supply continuously low voltage lighting devices preventing risks of indirect contacts.



### 8. Burner and venting control

ESB and EN contactors provide efficient load control, for single and three phase loads up to 63 A of rated current. Thanks to their endurance and high switching capacity ESB and EN are ideal in automation of frequently operating loads.



### 9. Object metering

Heating and ventilation pumps are obvious candidates for object metering in the home, and these can be joined by appliances such as electronic equipment, washing machines, dishwashers as well as sauna. And don't forget outdoors.

Garden terrace heaters space and lighting plus the pond pump are all significant 'energy thieves'. The actual consumption is easy to measure with EQ meters. EQ meters A-series measures in two directions, so it is suitable for a residential PV application.



### 10. One complete solution for your home

Electrical enclosures for the residential applications coordinate between all technical elements that make up the interior essential in today's homes. The AT & U compact distribution boards from ABB response this trend about an ever increasing offer of products for home installations. ABB offers with AT & U cabinets one complete solution for all electrical installation requirements in your home.





# An offering designed to meet present and future needs

1

The measure of an offering's worth is its completeness and integration. ABB offers solutions that meet and anticipate all the needs of contemporary life: from video entry phones and video surveillance to home automation and charger systems for electric vehicles.



## 1. Home series

The ABB residential series are the best available on the wiring accessories market. The materials, shapes and colours of plates and controls can be matched, with umpteen combinations, adding value to environments based on your taste, fantasy and needs.

Aesthetics must not sacrifice safety and comfort. The series have a complete energy and alarm functions line, from control devices to plugs, from safety and comfort devices to alarm units, from protectors to detectors, from limit switches to special systems, from domotic bus solutions to installation components.

The series are all integrated with ABB products portfolio, ensuring modular architecture that is always expandable.



## 3. Home automation and security systems

ABB home automation systems turn a house plant into an intelligent system, adaptable to the wellness, safety, protection and saving needs of whoever lives in it.

ABB domotic line modularity can be adapted to any type of building, giving us full, integrated management of safety and comfort functions. From anti-intrusion control to managing lighting, to operating loads for greater energy efficiency, ABB domotic systems on bus are easy to install, program and use, with decided modular features guaranteeing the plant can grow based on a customer's evolving needs.



## 2. Entry phone/ Video entry phones

ABB systems offer solutions which enable you to implement entry phone and video entry phone systems for single homes and large residential complexes really easily.

Integrating any internal or external architectural style, these products offer users the most advanced functions and are available in analogical, digital and even wireless versions.



## 4. Comfort control, security system and radio video surveillance

Available in wired or wireless versions, both analogical and fully digital, ABB solutions allow users to create an inviolable, customised safety barrier between the house and its outside area. Signalling effective danger or discomfort situations, they guarantee users full control over the perimeter.

Reliable and technologically advanced, the ABB burglar alarm and video entry phone lines are modular and integrated with a modern, valuable design meaning they can be used in any architectural context.



### 5. Components for solar PV plants

ABB has developed a complete range of photovoltaic application products. They satisfy any plant need, from photovoltaic fields to micro domestic installations. Switches, isolators, dischargers, trackers but also measuring and control parts, control panels, distribution units... everything needed to integrate, monitor and protect the energy generated by house panels, in a safe, protected way.



### 6. Charger systems for electric vehicles

Electric vehicles are the new mobility frontier. E-mobility challenges are not just in the ability to generate energy but also in the possibility to integrate different sources, to accumulate excess production and dislocate safe, reliable charge points accessible for everyone, even in the home environment. For really personal, sustainable mobility ABB offers a rich catalogue of electric vehicle charging products, from turnkey solutions to single components.



### 7. External lightning protection with the OPR range

The ABB OPR range makes the construction of a lightning protection system very easy to install. Designed to conduct the lightning current from the external rod to the earthing system, it will keep your home safe and protected against any damage. When you have external protection, you must add a surge protection device (OVR range) to protect your electrical installation and sensitive equipment.



### 8. Switchboards protecting and isolating photovoltaic plants

ABB offers the best solutions to protect, isolate and cut off photovoltaic sources.

In particular, string combiners - consolidating DC energy produced by the different strings making them available for inverters – allow to protect against overcurrents, lightnings and surges.



### 9. Selective device downstream from the meter

The S700 series products are selective main circuit breakers for DIN rail enabling you to protect electric installations from surges. They boast total selectivity towards MCBs downstream and considerable selectivity towards protection devices upstream. As they have been designed for the IV overvoltage category and integrate the isolation function they can be used in any distribution or control cabinet.



# Efficiency, protection, comfort: measuring a system's value

1

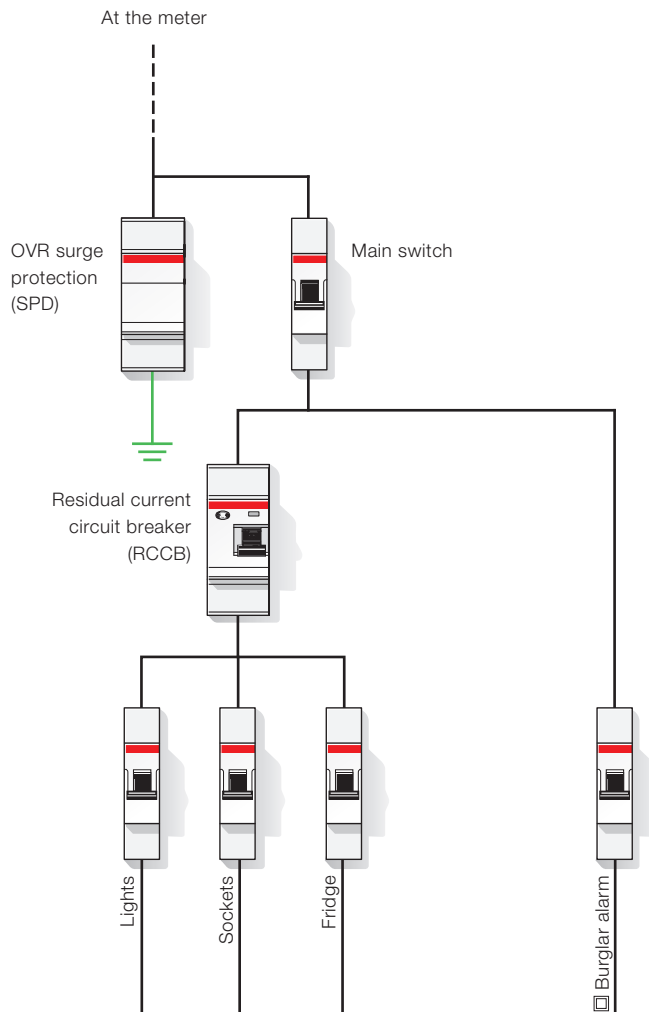

## Small flat

In a small apartment plant simplicity and relative extension allows you to keep load subdivision to a minimum.



**Small flat**

For a minimum amount of selectivity you can give to each circuit a differential protection.

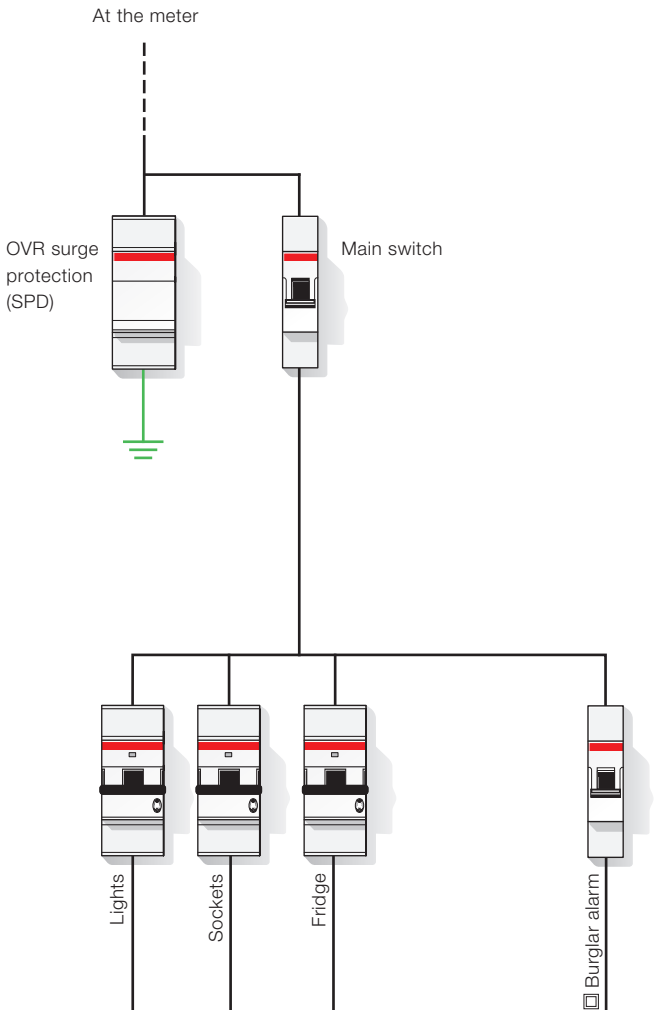

# Efficiency, protection, comfort: measuring a system's value

1

## Medium flat

In a medium sized apartment the right subdivision of circuits allows easier plant management and makes searching for any breakdowns simpler.

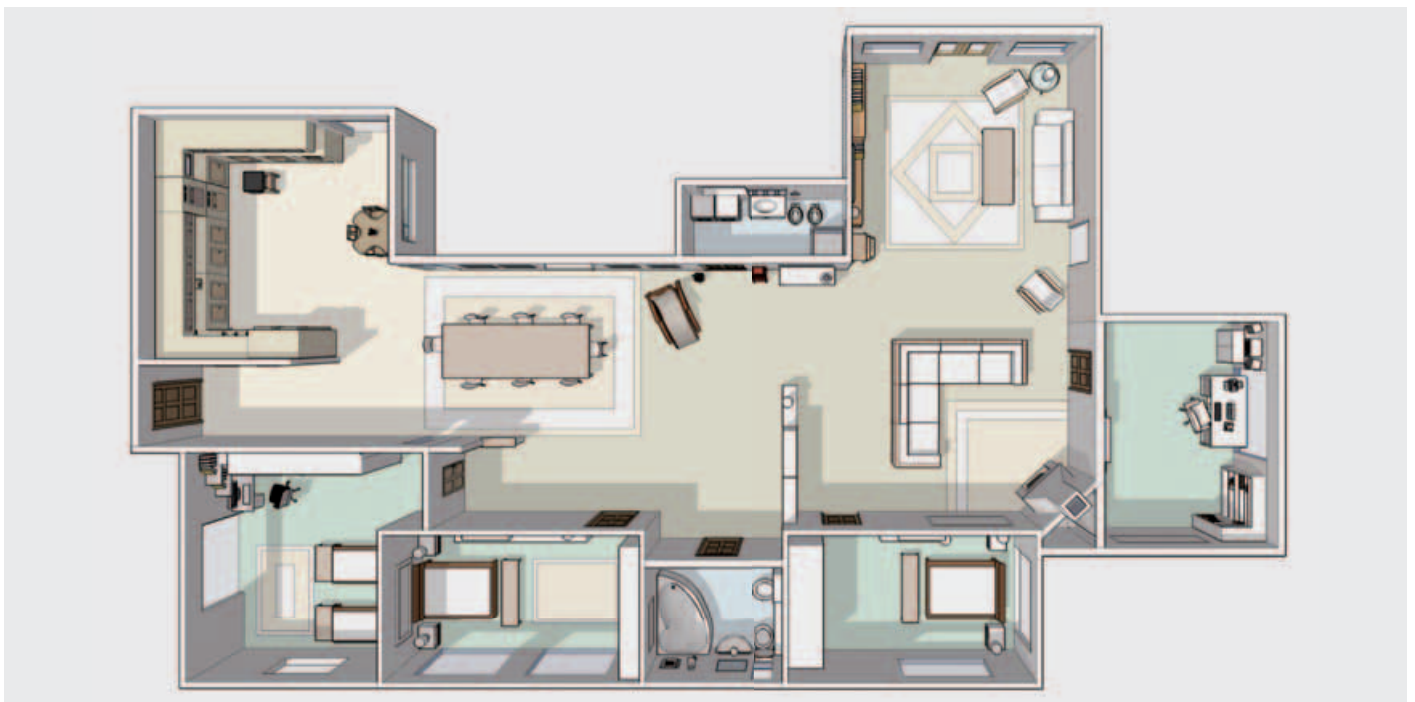
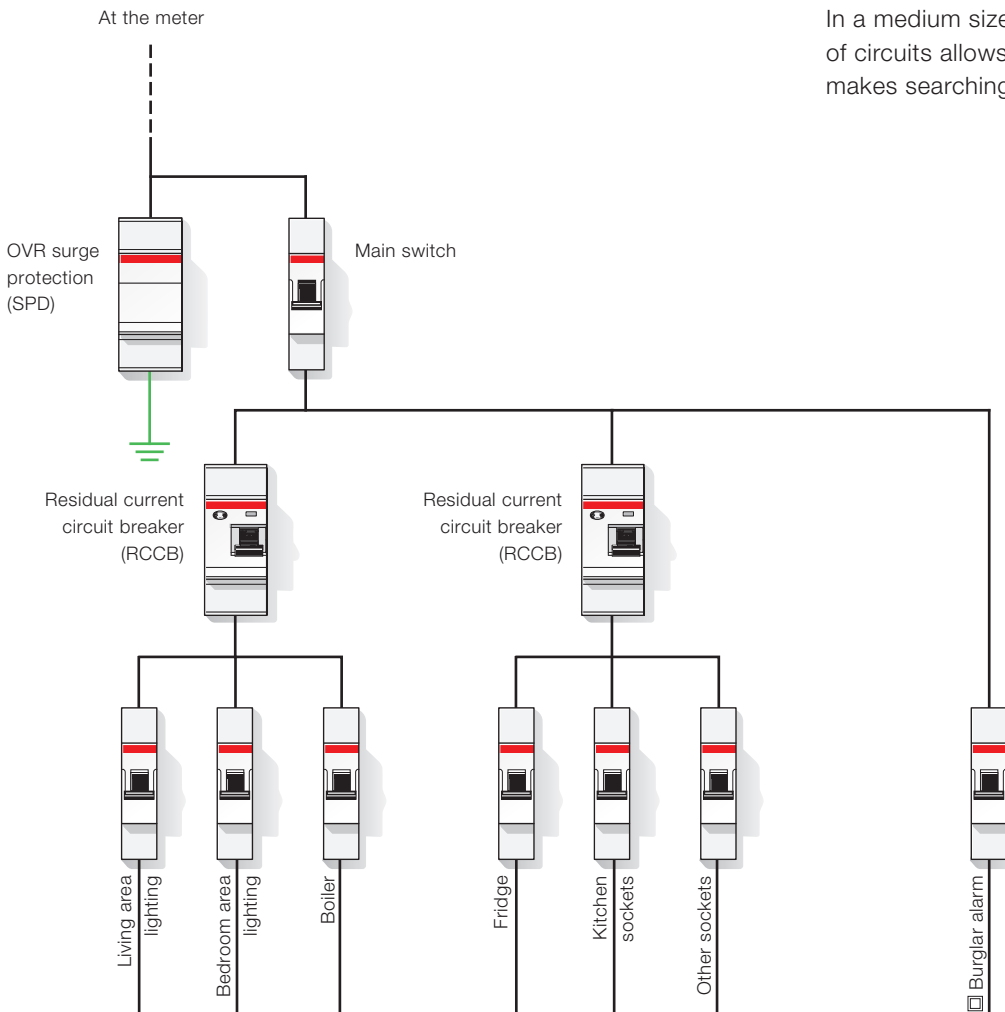



**Medium flat**

The certainty that you can just disconnect the fault affected circuit is only possible with differential protection on each single circuit.

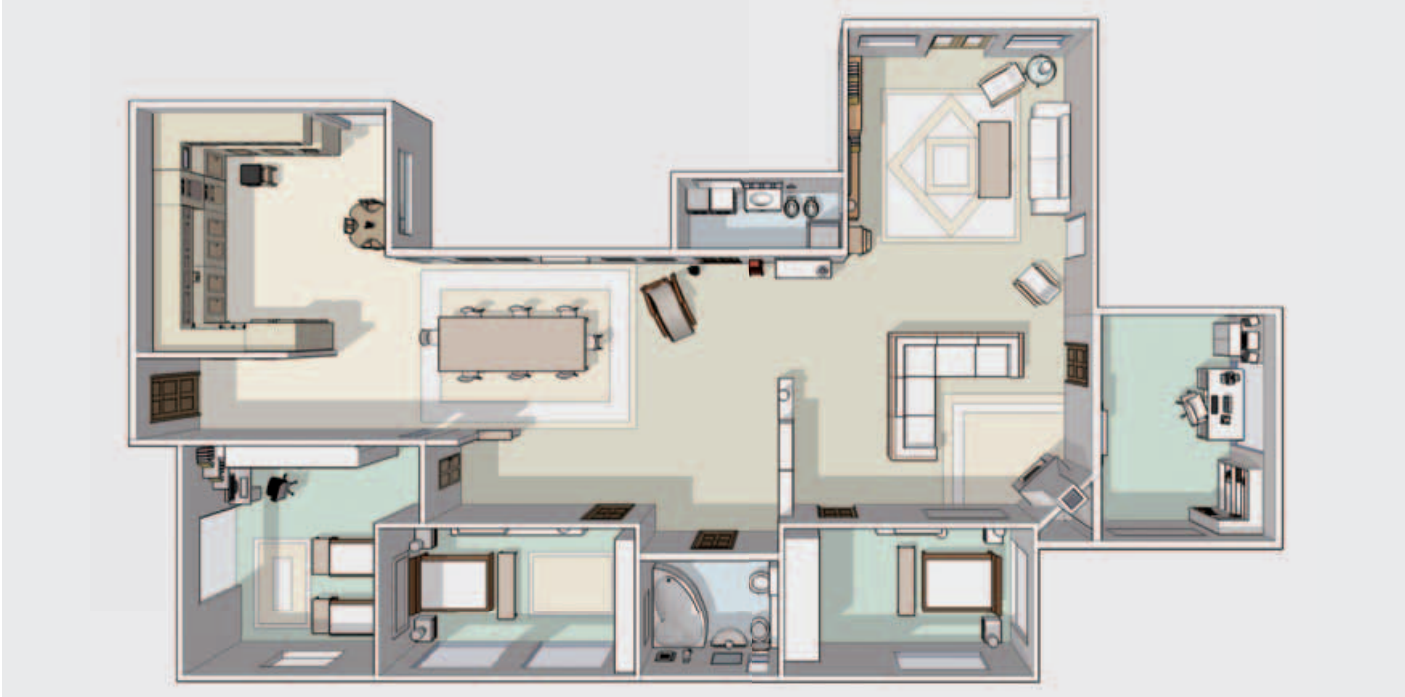
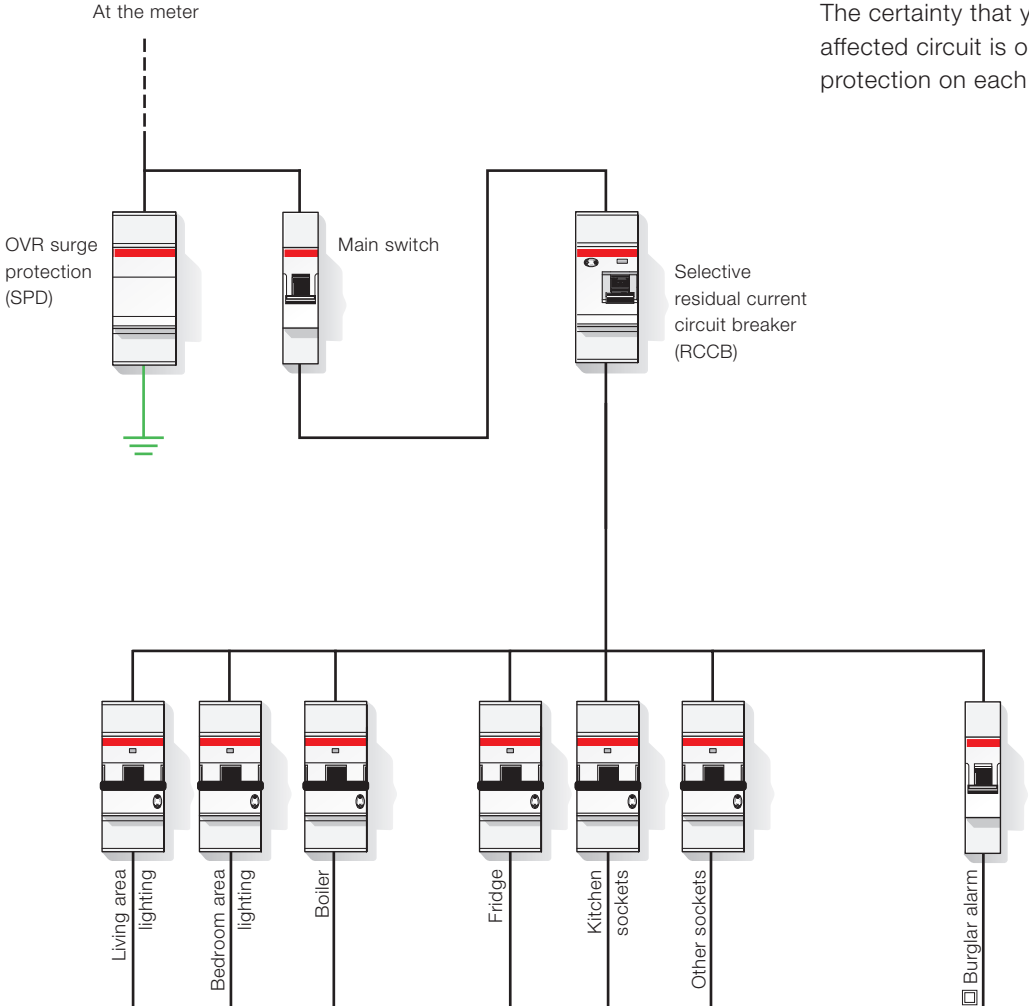

# Efficiency, protection, comfort: measuring a system's value

1

## Detached house

In a detached house the right subdivision of circuits allows easier plant management and makes searching for any breakdowns simpler.

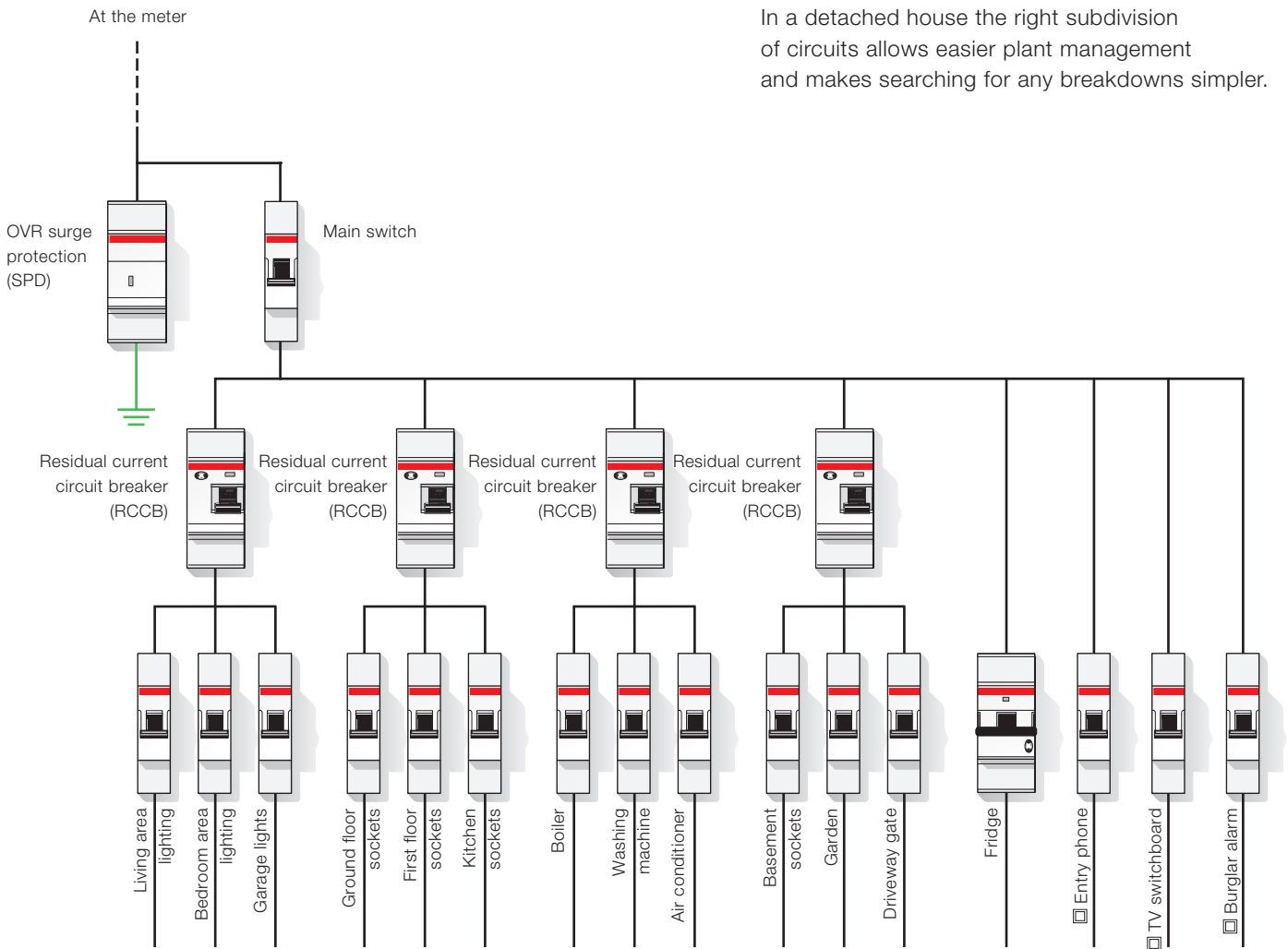

**Detached house**

Full plant selectivity allows all circuits not affected by a breakdown to carry on working guaranteeing full efficiency for the rest of the plant, avoiding unpleasant disservices.

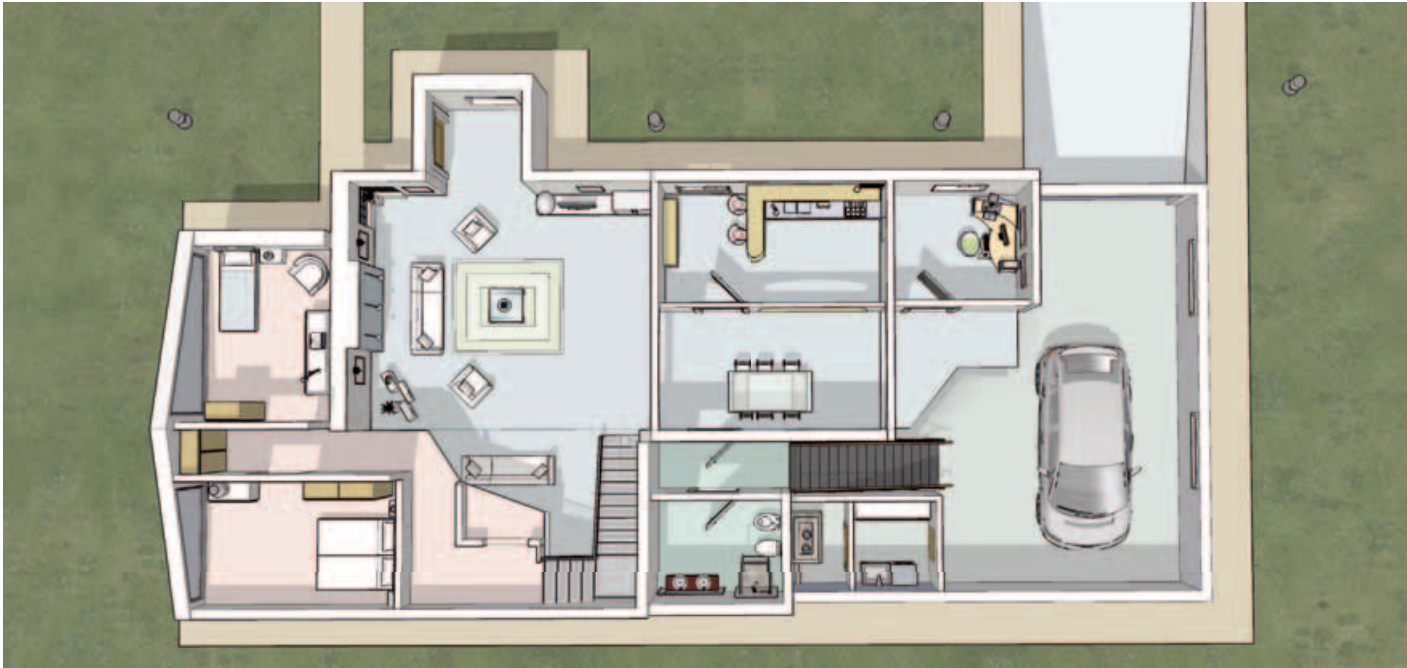
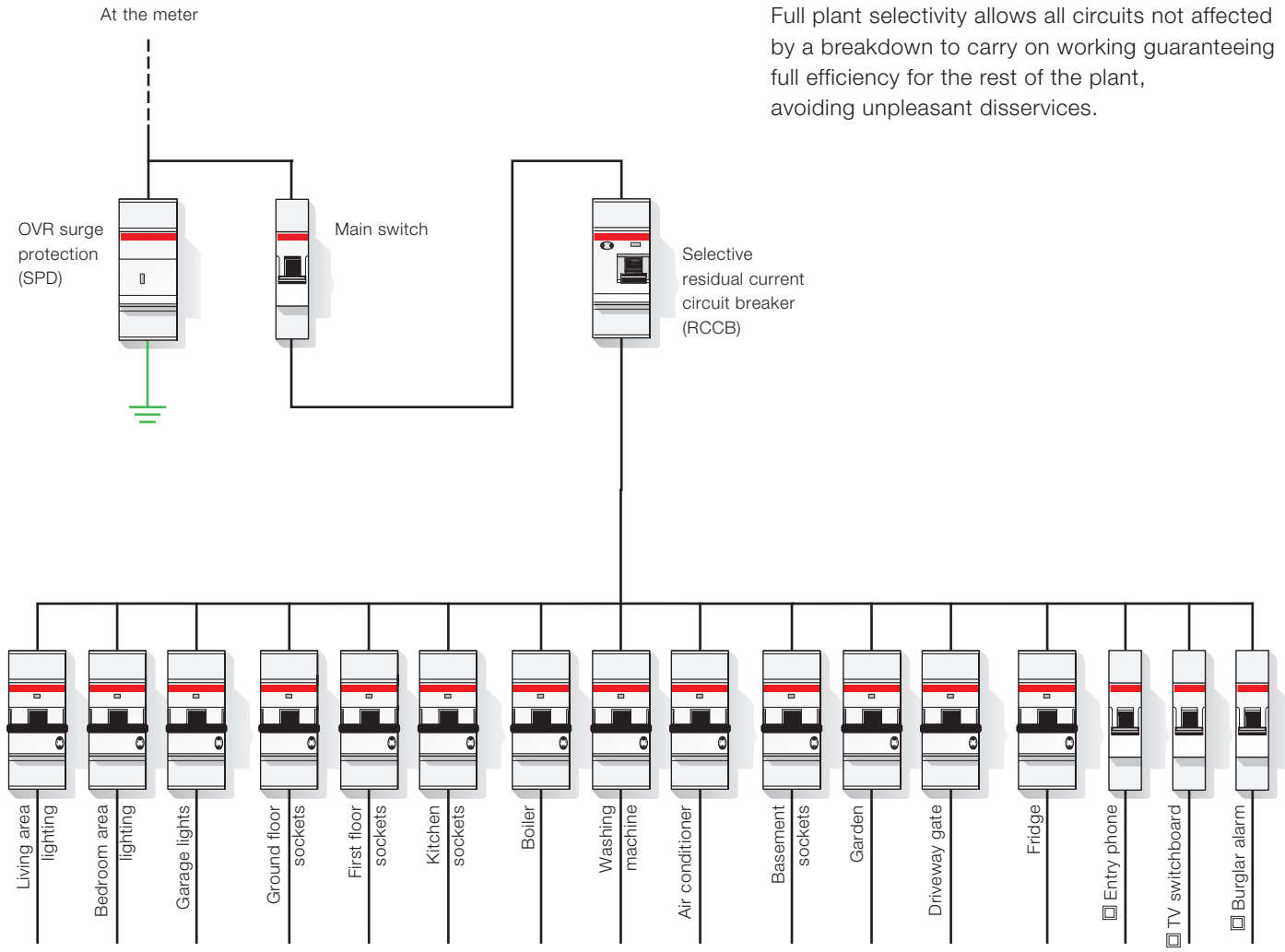

# Application examples

## OVR PLUS N1 40

### Self-protected surge arrester

1

#### Operating principle

The OVR PLUS N1 self-protected surge arrester protects your equipment and installations without worrying about coordination with specific backup protection.

#### Application environments

The OVR PLUS N1 surge arresters are recommended for environments where it is necessary to have a safe, compact, easy to install surge protection solution.

#### Example of installation

One of the possible applications is to mount the OVR Plus N1 40 on a house's distribution board. The benefits of easy installation and minimum space requirements will save rooms and will safely protect your house against transient surges.

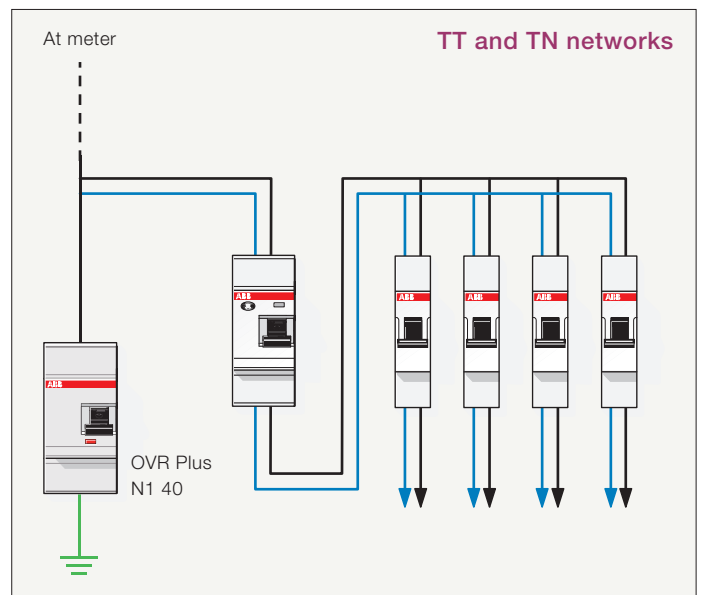

# Application examples

## EQ meters A-series

### Electronic energy meter

#### Operating principle

EQ meters A-series are available for both single phase and three phase networks. They allow active energy or combined (active and reactive) energy to be measured.

EQ meters A-series measures in two directions, both import and export of energy. The meters are prepared for external communication via their built-in communication interface or via a serial communication adapter (SCA).

#### Application environments

The EQ meters A-series meters offers an ideal solution in measuring applications for electrical energy produced in a photovoltaic installation.

#### Example of installation

EQ meters A-series can be easily integrated into measured data collection systems via serial communication adapters. The devices are approved to the Measuring Instruments Directive (MID) European Directive 2004/22/EC.

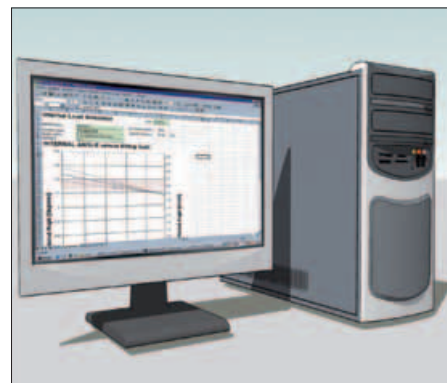
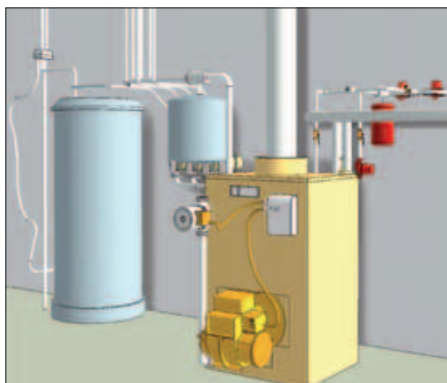
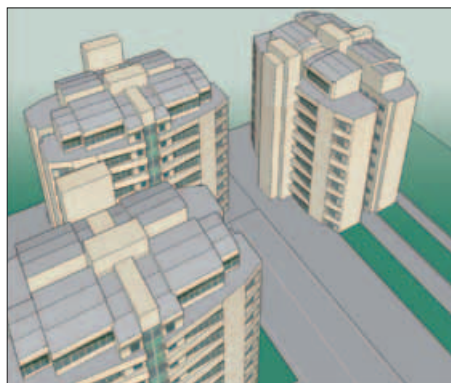
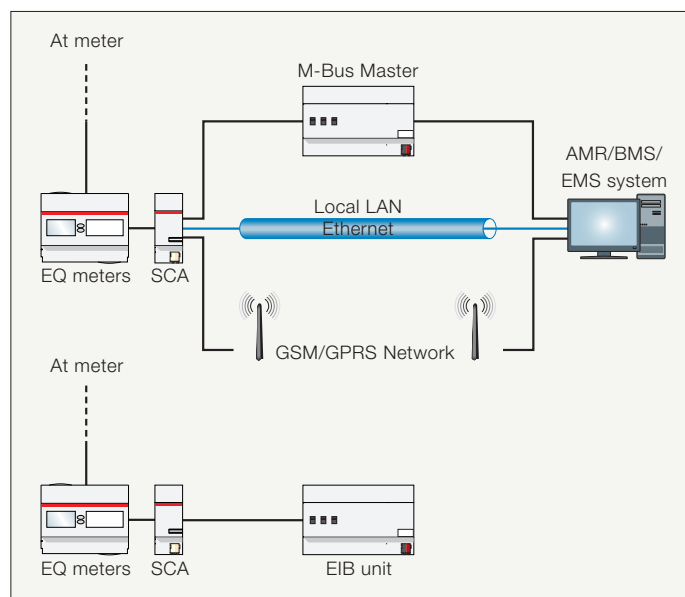



# Application examples

## E 259 installation relays

1

### Operating principle

The E 259 installation relays are 16 A contactors specifically engineered for residential and commercial applications and are available in a wide range of contact layouts and coil voltages.

### Application environments

The E 259 installation relays are particularly indicated in residential and commercial buildings for lighting control.

### Example of installation

The E 259 16-11 installation relay can be installed with a NO and a NC contact inside the lighting system of the common areas of a building. The first control sent through a switch to the command circuit of the relay will turn off the ceiling lights and turn on the corridor lamps, while the second command returns to the previous state.

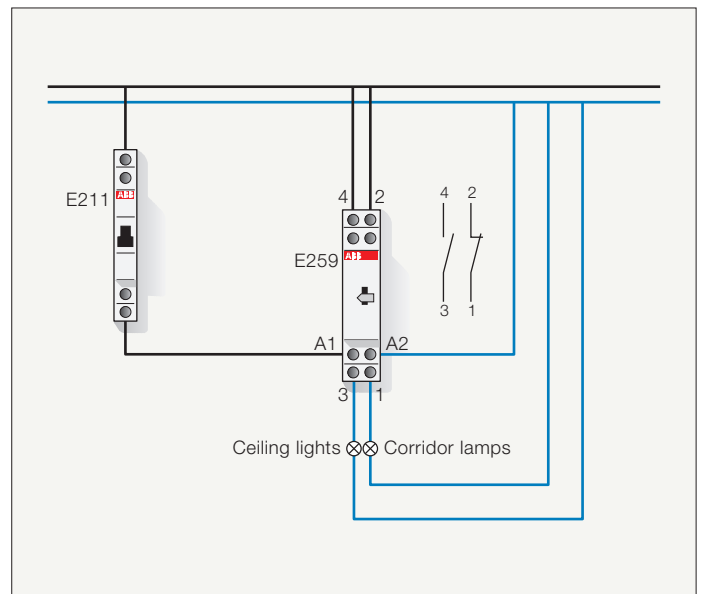

# Application examples

## AT electro-mechanical time switches

### Operating principle

The AT electro-mechanical time switches enable to control the circuit opening/closing according to a daily or weekly program or to manually set permanent ON/OFF operation.

### Application environments

The AT electro-mechanical time switches are particularly indicated in any environment and situation where it is necessary to program system load operation according to a daily or weekly frequency (shop lighting system, public buildings, heating systems, irrigation systems, etc.).

### Example of installation

The AT3-7R electromechanical time switch can be assembled inside the power supply circuit of the garden. In this case the device programming enables the daily activation of the irrigation system at a preset time.

1

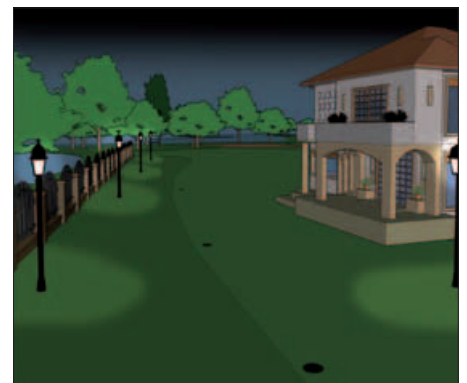
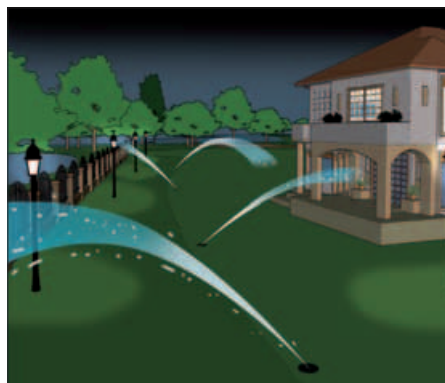
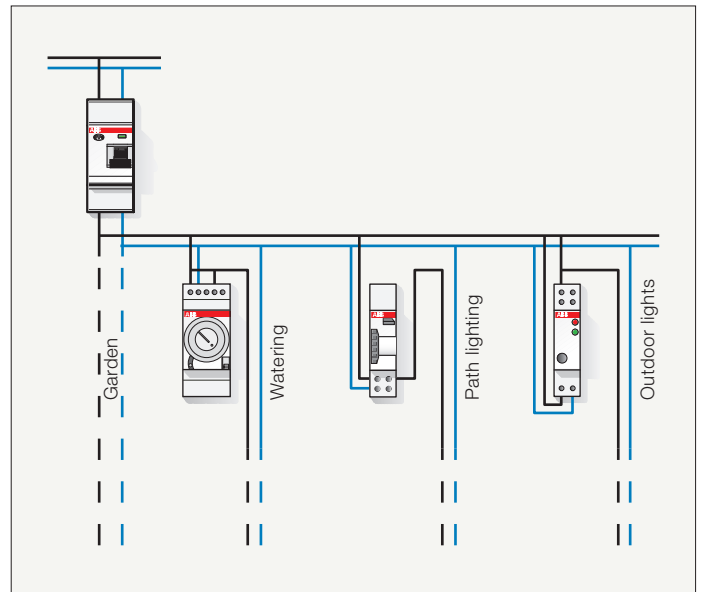

# Application examples

## D Line digital time switches

1

### Operating principle

The D2 two-channel digital time switches enable to open and close circuits according to a daily or weekly program, controlling single loads or group of loads even when they require different time controls with a common time reference.

### Application environments

The D2 two-channel digital time switches are particularly indicated in environments and situations requiring the management of multiple loads according to a time program flexible enough to include or exclude their application based on the day of the week (offices, schools, public areas, etc.).

### Example of installation

In this example, the digital time switch D2 allows the operation of heating as well as lighting systems of a small office; during weekend the device only controls the heating system (programmed on one of the two channels), while on the rest of the week the lighting system is also switched on (through a program on the second channel).

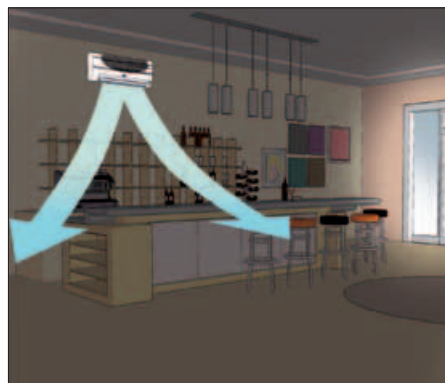
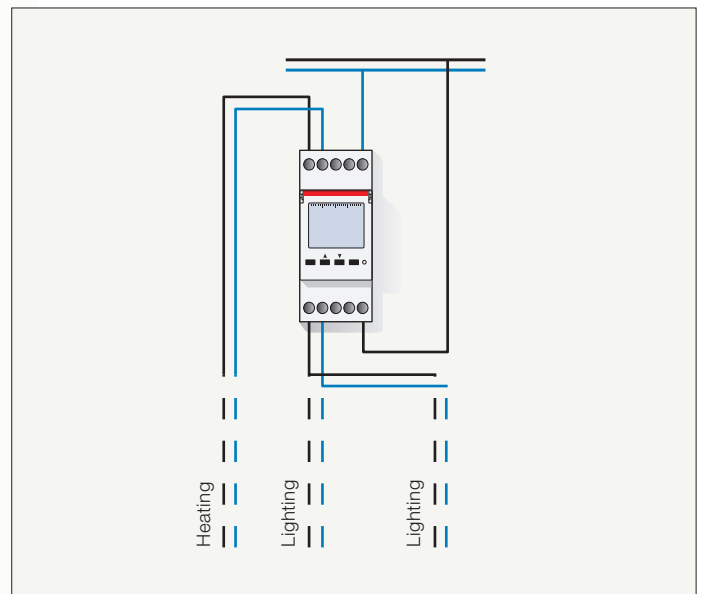



# Application examples

## E 232 staircase relays

### Operating principle

Activated by a pulse command of a push-button, the E 232 staircase switch turns on the plant's light for a T1 time that can be protracted, with a 50% dimming of the light intensity, by means of the parallel wiring of a HLM half-light module.

### Application environments

Installation of E 232 staircase switch, coupled with the HLM half-light module, can be ideal wherever timing of the lighting is requested (staircase and pathways of public places, cellars, garage, etc.).

### Example of installation

One of possible applications of the E 232 staircase switch, coupled to a HLM half-light module, in the staircase lighting plant of a multistory building. Pushing the push-button, the timer of the E 232 switch turns on the lights for a settable T1 time. At the end of T1 time, the HLM half-light module dims the light by a 50% for a T2 time in the while is possible turn on again the full lighting.

1

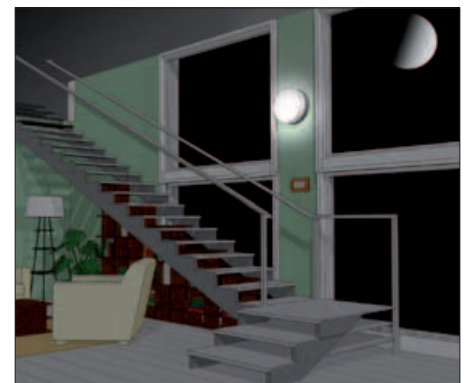
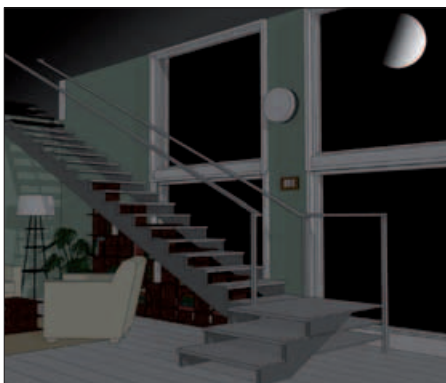
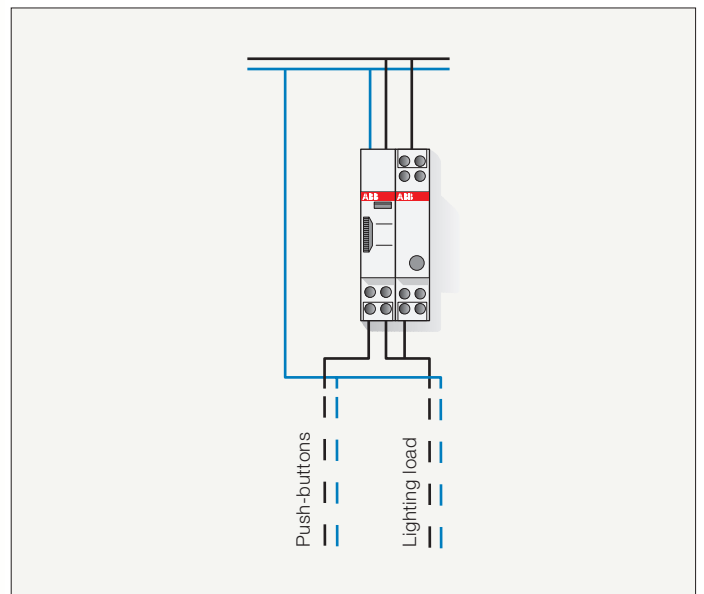

# Application examples

## TWP twilight switches for pole mounting

1

### Operating principle

The TWP pole mounting switch equipped with an integrated photo-sensor preset at 10 Lux is the ideal solution for controlling external lighting systems. They are supplied with water-proof cable glands, user instructions printed on the back of the product and a pull-out sensor that allows fast, safe and error-proof maintenance operations.

### Application environments

The pole mounting TWP twilight switch installation can be ideal to light command in private parking areas thanks to its capability of installation in pole, lamppost, etc.

### Example of installation

One of the possible applications concern the installation of a pole mounting TWP twilight switch in lighting plant. When daylight dims below a set level (e.g. during twilight) the switch turns on the lighting devices, assuring the requested lighting. At dawn, when the light raise above the set threshold, the relays of TWP returns in open position.

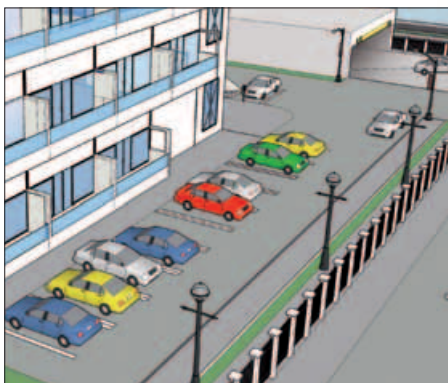
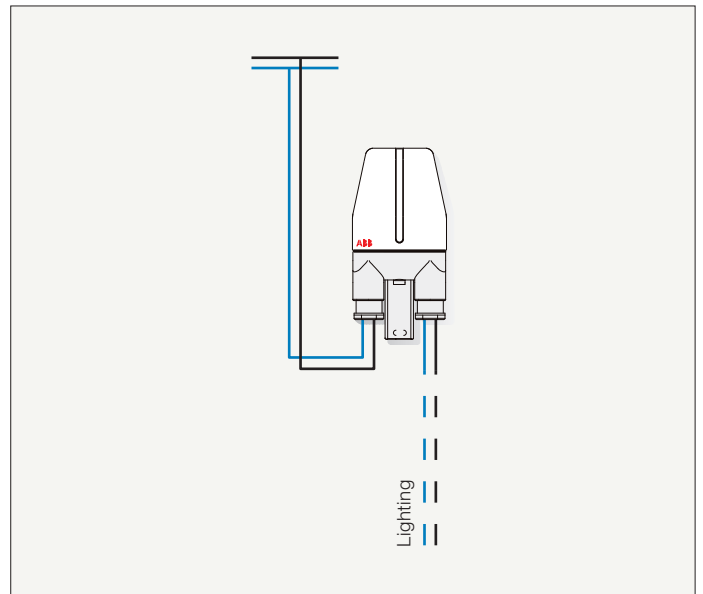

# Application examples

## TWA twilight switches

### Operating principle

Installation of a twilight astronomical switch in a system is particularly useful in places and situations where light sources or other environmental conditions may cause changes in the Lux level. In these cases, TWA-1 and TWA-2 enable control of the lighting system depending on the time when the sun rises and sets, based on the geographic location where they are installed.

### Application environments

The TWA-1 and TWA-2 twilight astronomical switches are particularly suitable for use in applications where the operation of a twilight switch with external sensor is potentially subject to alteration or damage from external agents (e.g. smog, overexposure to light, vandalism etc.).

### Example of installation

One cause of reductions in the level of ambient light is atmospheric smog. Particle deposits on the external sensor of a traditional twilight switch can over time compromise its operation, preventing the activation of the lighting systems controlled. As illustrated in the diagrams, it is possible to counter this type of problem by installing a TWA twilight astronomical switch, which controls the lighting based on the ambient light level calculated from the preset longitude and latitude parameters.

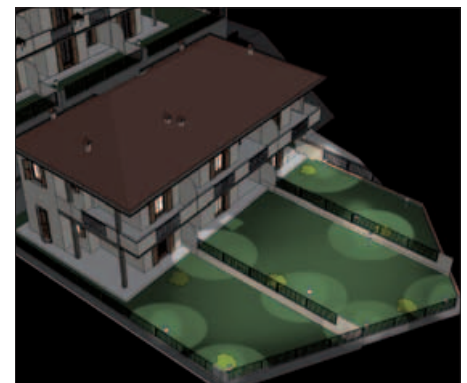
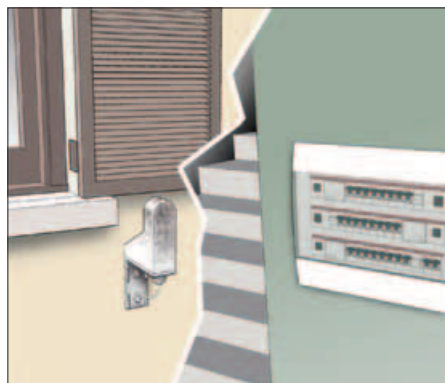
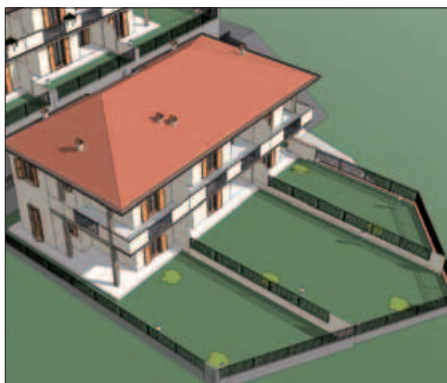
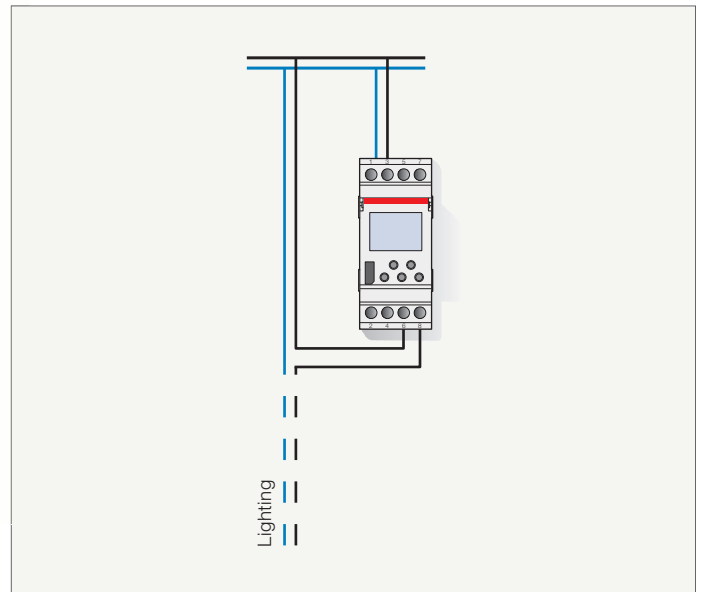

# Application examples

## ATT-22 GSM modules

1

### Operating principle

ATT-22 module is a GSM terminal with 2 outputs and 2 inputs for transmitting commands and alarms via SMS message, free phone call ring, fax or e-mail. Configuration is accomplished by means of SMS messages, or using the ATT-Tool software with ATT-22 connected to a PC.

### Application environments

The ATT-22 module is especially suited for residential and services-sector installations in which loads need to be remotely monitored or controlled. ATT-22E version is equipped with a pre-wired external antenna, indispensable when the module is installed in places that do not guarantee adequate GSM coverage.

### Example of installation

The figures illustrate an example application in which ATT-22 module is installed in the control panel of a second home in the mountains.

With a cell phone call ring to ATT-22, it is possible to switch on the boiler just before arriving at the house, or to keep it continually in operation. In the event of a problem with the boiler, ATT-22 sends a notification SMS.

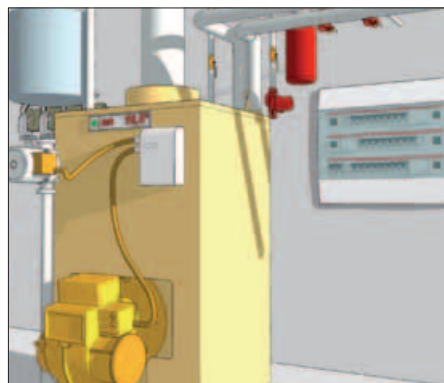
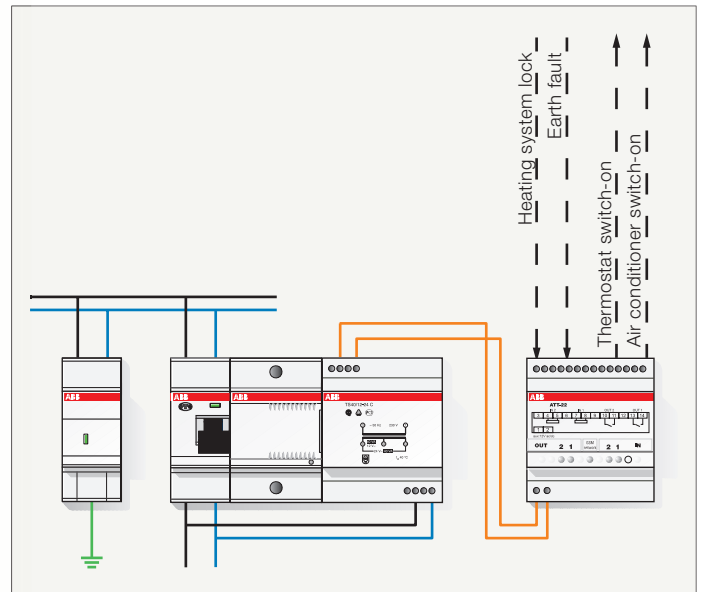

# Application examples

## RAL overload alarms

### Operating principle

The RAL overload alarms constantly compare the maximum preset power consumption value to effective system power consumption. Approaching allowed threshold, they signal to disconnect one of the loads through acoustic alarm avoiding the main circuit breaker tripping. Connecting the undervoltage release to the appropriate contact, the RAL overload alarms provide an acoustic alarm and simultaneously opens the circuit-breaker protecting one or more not primary loads.

### Application environments

The installation of the RAL overload alarms is suitable for any environment and situation in order to avoid power consumption which could trip the limiting circuit breaker of the system.

### Example of installation

As shown in the diagrams, one of the possible applications is the installation of the RAL overload alarms in the domestic system where the electric oven and washing machine are simultaneously switched on increasing the power consumption. When the power consumption approaches the preset threshold values, an acoustic alarm is activated and the washing machine switches off automatically through an undervoltage release.

1

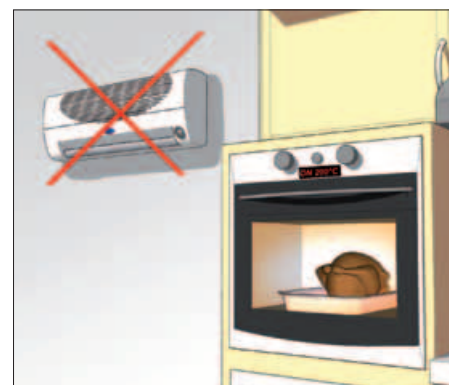
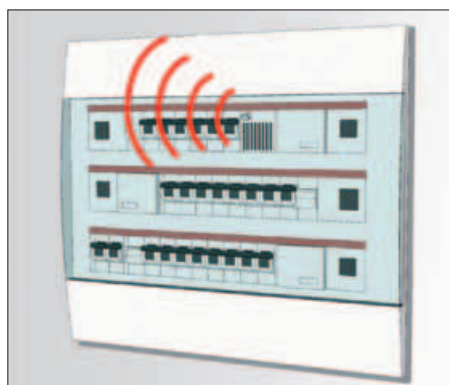
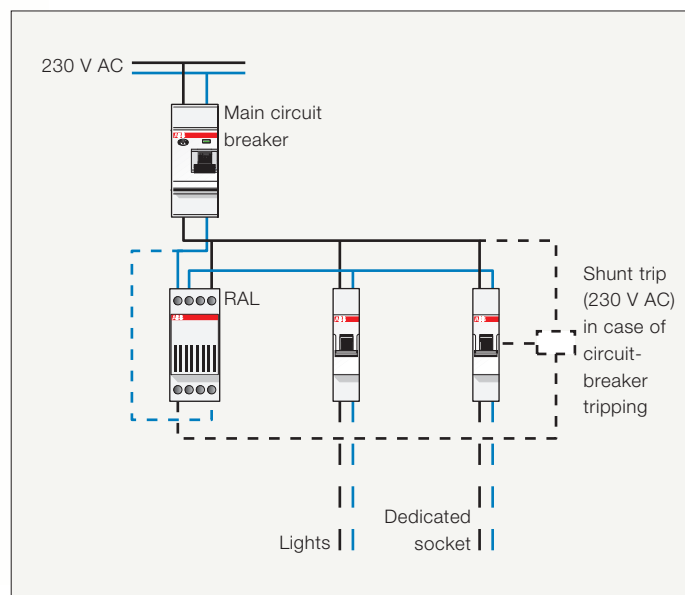



# Application examples

## F2C-ARH

1

### Operating principle

The GreenLight F2C-ARH automatically recloses the associated residual current device (2 poles RCCBs up to 63A - 30 mA or 100mA, depending on F2C-ARH version), after first checking that there isn't an insulation fault on the circuit protected by the RCCB.

### Application environments

The GreenLight F2C-ARH is suitable for installation in any TT and TN distribution system and it has been designed to always maintain continuity of service in case of nuisance trippings caused by storms or electrical disturbances, restoring current to all connected utilities after verifying the correct state of the system.

### Example of installation

An ideal application of auto-reclosing device F2C-ARH is related to home distribution systems. This is particularly useful to preserve the critical loads - for example to avoid alarm system wrong intervention, irrigation stops or defrost of the freezer - during holidays or when the home is not manned, even for short periods.

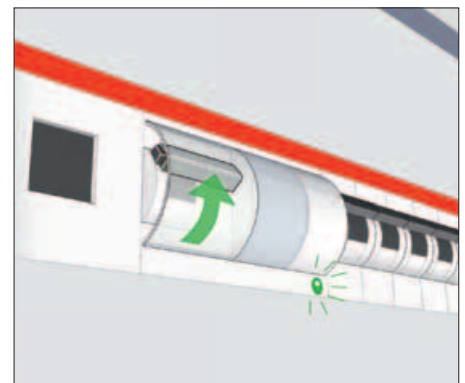
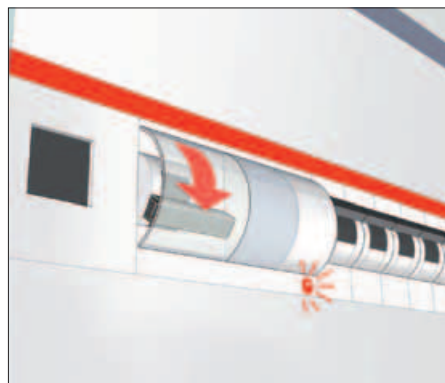
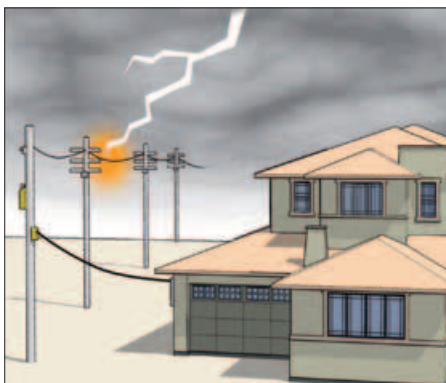
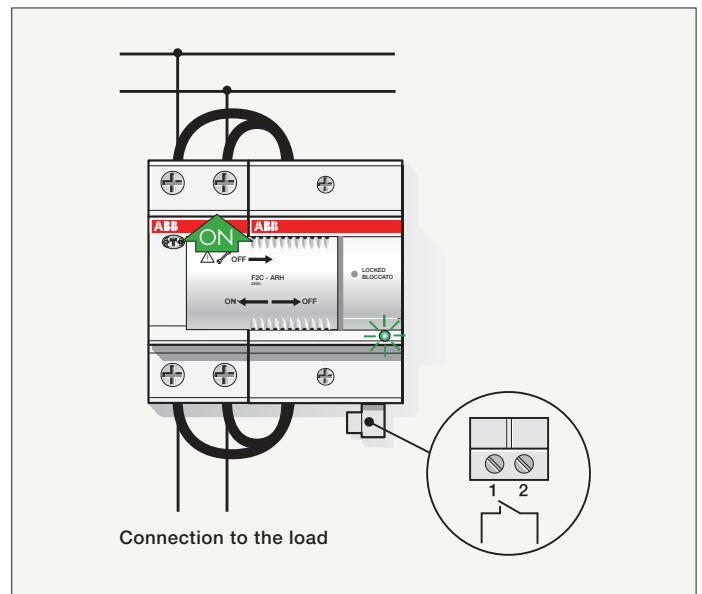

# Application examples

## LSS

### Operating principle

LSS1/2 load shedding switches are used in case of exceeding of consumption threshold allowed in the system by switching off in sequence one or two loads, if necessary. At preset intervals and until current consumption is not below the reference level, the switch tries to reset the disconnected loads.

### Application environments

The installation of the LSS1/2 load shedding switches is suitable for any environment and situation where it is necessary to control electric energy consumption within consumption limits allowed in the system.

### Example of installation

As shown in the diagrams, one of the possible applications is the installation of the LSS1/2 load shedding switches in a printing office system, where the conditioning switch-on causes the exceeding of the energy consumption threshold defined with the supplying company by contract. The LSS1/2 load shedding switch preserves printing machines operation by switching off one or two primary loads automatically (i.e. night conditioning and lighting), where ON red leds indicate temporary OFF. After a preset interval, the switch checks that current consumption values fall within the limits again trying to reset the previously disconnected loads.

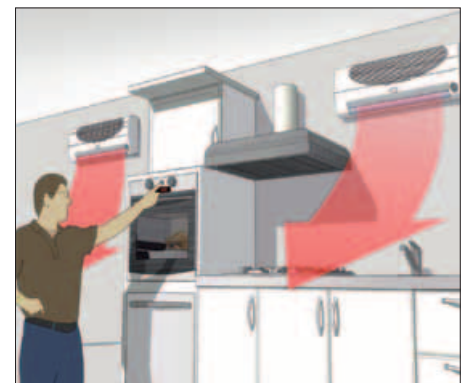
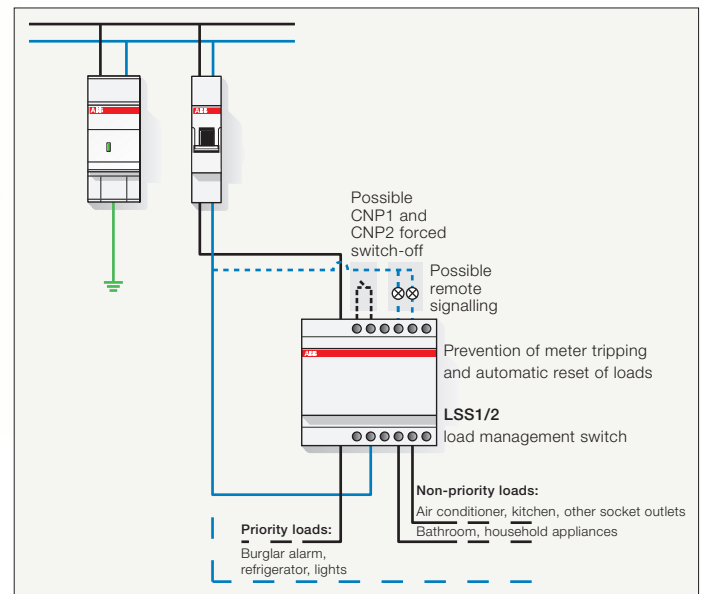
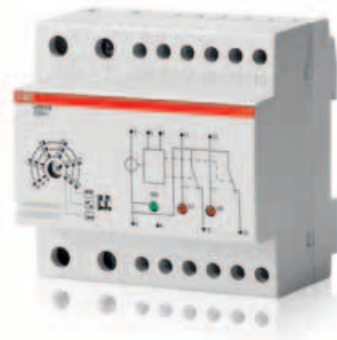

# Application examples

## TM, SM

1

### Operating principle

A residual current circuit breaker with  $I_{dn}$  equal to 10 mA installed on the bathroom circuits ensures better protection against indirect contacts. The residual current circuit breaker may be installed directly on the control board.

### Application environments and example of installation

The SELV circuit guarantees safe power supply where the risk of accident is higher, such as near the bathtub.

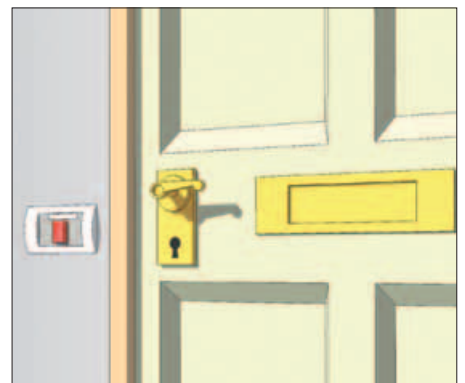
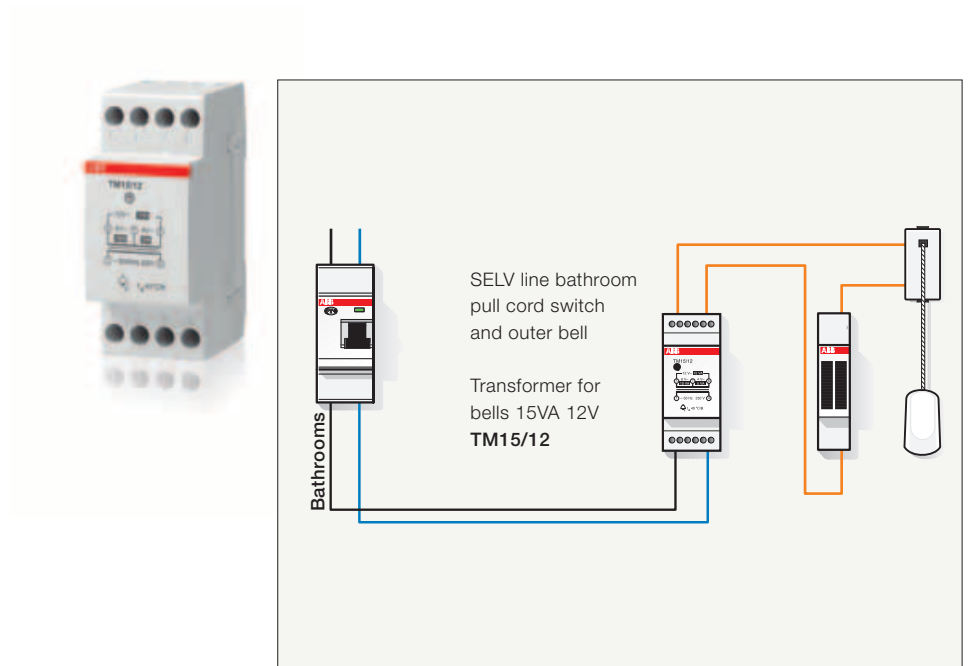



# Protection

Introduction	2/2
Miniature circuit-breakers	2/5
Residual current devices	2/29
Surge protective devices	2/55
Other protection devices	2/63
Busbars and end caps	2/77

# Constant attention Protection, selectivity and savings: ABB's mission for your home

Protecting the electrical system is an essential step to ensure safety and comfort to its users, as well as the correct economical and functional operation of the devices it supplies.

2



Protection aims at minimizing risks for people and devices due to abnormal conditions or faults that impair the electrical parameters of the installation and of the loads. In this context, an adequate coordination between the various protection devices (normally located on the sections of the system or on specific components) and an appropriate degree of selectivity enable to provide total safety of the installation. For the system to operate properly, protection has to allow quick identification and exclusion of the area affected by the problem, without hasty, inappropriate or untimely actions that may compromise the power supply to the unaffected areas. In case of tripping of a protection device, the maintenance personnel should have clear and essential information rapidly available in order to restore the service as quickly as possible. A protection system must also provide adequate flexibility and include reserve mechanisms, in case of malfunctioning of the main protection unit.

For a good compromise between reliability, simplicity and convenience, a protection system must be able to identify how and where the fault occurred, differentiating between abnormal but tolerable situations and actual situations. It is imperative to act as quickly as possible to minimize risks and damage (destruction, accelerated aging, etc.), safeguarding the continuity and stability of power supply. Along with their quality, ease of installation the modular products for DIN rail proposed by the ABB Compact Home catalogue combine features that enable to reconcile two seemingly conflicting needs: accurate identification of the fault and effectiveness of action. Although a marked selectivity of protective devices is rarely required by the applicable regulations and may seem unwarranted, designing a selective system means choosing a much more efficient, cost-effective solution, suited to the needs of the users and perfectly made, beyond the simple regulatory aspect.

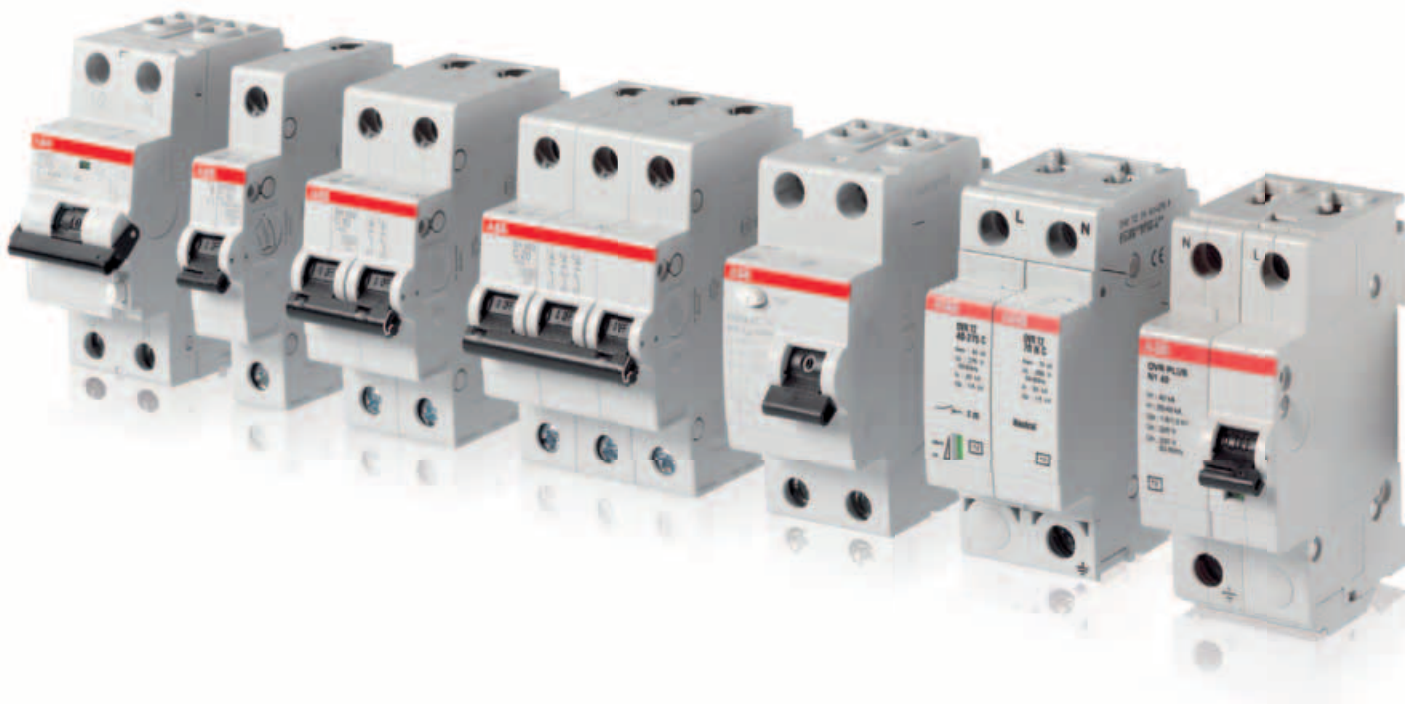





# Miniature circuit-breakers

## SH 200

Plus of range	2/6
Technical features table	2/8
Ordering information	2/10
Technical details	2/22
Overall dimensions	2/27

# MCB SH 200. The details make the difference

A range designed to ensure efficiency and protection

2

25 mm<sup>2</sup> cage terminals, a well proven and reliable technology.

IP20 - finger safety.

Scratch and solvent resistant marking due to laser printing. Easy identification of the products in case of maintenance or replacements.

Laser printed EAN code. Easy integration into merchandise management systems and quick identification of devices.

Easy product coding - easy identification - easy life. Basic technical information already integrated into the name.

Wiring diagram and basic technical specification printed on the front of the MCB. Save your time - all important data available right away.

Don't loose what's important for you - captive screws.

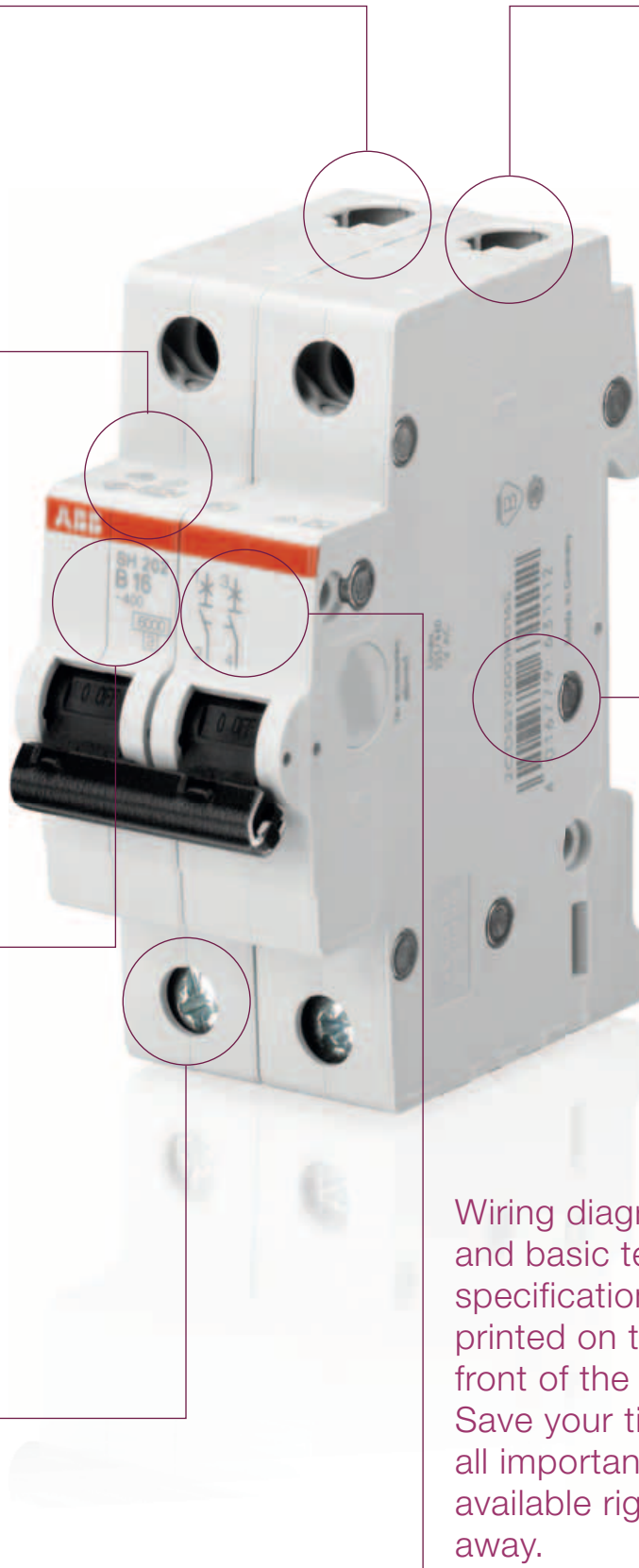



**CPI**

All Compact Home MCBs are suited with a contact position indication (CPI) on the toggle. You can easily identify, if the MCB is in ON or OFF position – **easy and safe maintenance work is possible.**

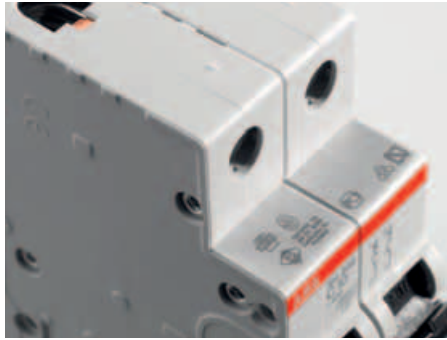

**Approvals printed on the dome**

SH 200 MCBs comply to IEC/EN 60898 and carry all relevant approval marks for each market they are destined to. The certification marks are also printed on the dome of the MCB. Thus make it possible to see the markings also in the mounted position. **For control and acceptance procedure – certification marks visible on fitted devices on the side of mounting.**

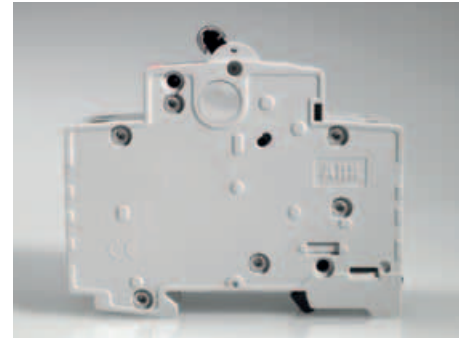

**Housing material**

By using the state-of-the-art housing material, ABB is taking care of the environment. With the latest generation of thermoplastics it's possible to recycle the MCBs – especially the thermoplastic housing-material can be re-used. By using the latest generation of thermoplastics the material stability of all Compact Home MCBs is improved. **Residential MCBs are free of halogens – no environmental pollution.**



**Laser printing**

All printings of the Compact Home MCBs, like the approvals on the dome, the product identification, are printed by a laser. The laser printing ensures a friction, scratch and solvent resistant marking on the MCBs.

**Easy identification of the products in case of maintenance or replacements due to safe laser printing.**



**Connection of SH and S**

Compatibility with System pro M compact® is given in all kind of variations like insertion of 1 System pro M compact® MCB (e.g. K-characteristic) into an Installation with Compact Home components and Compact Home busbars. Also the combination of 1 Compact Home MCB with System pro M compact® components and System pro M compact® busbars is not a problem.



**Terminals**

The MCBs Compact Home are equipped with 25 mm cage terminals, a well proven and reliable technology. The cross wiring can easily be done by inserting the Compact Home busbars and then the incoming wires into one of the MCB's terminals. The terminals accept Compact Home busbars and conductors up to 16 mm<sup>2</sup> together.

# Technical features table for miniature circuit-breakers SH 200 Series

2

Standards		
Poles		
Tripping characteristics		
Rated current $I_n$		A
Rated frequency $f$		Hz
Rated insulation voltage $U_i$ acc. to IEC/EN 60664-1		V
Overvoltage category		
Pollution degree		
<b>Data acc. to IEC/EN 60898-1</b>		
Rated operational voltage $U_n$		V
Max. power frequency recovery voltage ( $U_{max}$ )		V
Min. operating voltage		V
Rated short-circuit capacity $I_{en}$		kA
Energy limiting class (B, C up to 40 A)		
Rated impulse withstand voltage $U_{imp}$ (1.2/50 $\mu$ s)		kV
Dielectric test voltage		kV
Reference temperature for tripping characteristics		°C
Electrical endurance		ops.
<b>Mechanical Data</b>		
Housing		
Toggle		
Contact position indication		
Protection degree acc. to EN 60529		
Mechanical endurance		ops.
Shock resistance acc. to IEC/EN 60068-2-27		
Vibration resistance acc. to IEC/EN 60068-2-6		
Environmental conditions (damp heat cyclic) acc. to IEC/EN 60068-2-30		°C/RH
Ambient temperature		°C
Storage temperature		°C
<b>Installation</b>		
Terminal		
Cross-section of conductors (top / bottom)		mm <sup>2</sup>
Torque		Nm
Screwdriver		
Mounting		
Mounting position		
Supply		
<b>Dimensions and weight</b>		
Mounting dimensions acc. to DIN 43880		
Pole dimensions (H x D x W)		mm
Pole weight		g
<b>Combination with aux. elements</b>		
Accessories mountable		

\* Also fulfilling the requirement acc. to the protection degree IPXXB





ZCSC400030F0027



ZCSC400030F0015



ZCSC400030F0002

**SH 200**

**SH 200 L**

**SH 200 T**

IEC/EN 60898-1

1P, 2P, 3P, 4P, 1P+N, 3P+N

B, C

6...40 A

50 / 60 Hz

250 V AC (phase to ground) , 440 V AC (phase to phase)

III

2

1P: 230/400 V AC; 1P+N: 230 V AC; 2...4P: 400 V AC; 3P+N: 400 V AC

1P: 253 V AC; 1P+N: 253 V AC; 2...4P: 440 V AC; 3P+N: 440 V AC

12 V AC

6 kA

4.5 kA

3 kA

3

4 kV (test voltage 6.2kV at sea level, 5kV at 2,000m)

2 kV (50 / 60Hz, 1 min.)

B, C: 30°C

$I_n < 32A$ : 20,000 ops (AC),  $I_n \geq 32A$ : 10,000 ops. (AC); 1,000 ops. (DC); 1 cycle (2s - ON, 13s - OFF,  $I_n \leq 32A$ ), 1 cycle (2s - ON, 28s - OFF,  $I_n > 32A$ )

Insulation group II, RAL 7035

Insulation group II, black, sealable

Marking on toggle (I ON / 0 OFF)

IP20\*, IP40 in enclosure with cover

20,000 ops.

25 g - 3 shocks - 11 ms

5g - 20 cycles at 5...150...5 Hz with load 0.8  $I_n$

28 cycles with 55°C/90-96% and 25°C/95-100%

-25 ... +55°C

-40 ... +70°C

Cage Terminal

25 mm<sup>2</sup> / 25 mm<sup>2</sup>

2.0 Nm

No. 2 Pozidrive

On DIN rail 35 mm acc. to EN 60715 by fast clip

any

optional

Mounting dimension 1

85 x 69 x 17.5 mm

ca. 115 g

No

# Ordering Information

## MCB SH 200 T Series - B characteristic

2



SH201T-B

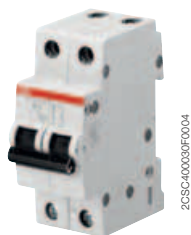

SH201T-B...NA

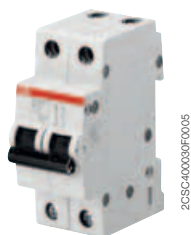

SH202T-B



SH203T-B

The SH 200 miniature circuit breaker is perfectly suitable for protecting lighting and power socket circuits that can be frequently found in residential areas. ABB used its years of experience with miniature circuit breaker to create this product by combining the optimum features for residential use alone.

The Compact Home range is versatile to provide the customer with the perfect solution for residential over current protection. It is available in tripping characteristics B and C type; with breaking capacities between 3 and 6 kA. As usual for ABB miniature circuit breaker, SH 200 is available from one to four poles and additional in one & three pole plus Neutral. The rated currents are limited to 6 A up to 40 A as it is common in residential applications.

N. of poles	Rated current	N° module [17,5 mm]	Bbn 4016779	Order details		Weight 1 piece Kg	Pack unit
	In A		EAN	Type code	Order code		
1	6	1	631921	SH201T-B6	2CDS231001R0065	0.125	10
	10	1	631952	SH201T-B10	2CDS231001R0105	0.125	10
	13	1	631976	SH201T-B13	2CDS231001R0135	0.125	10
	16	1	631990	SH201T-B16	2CDS231001R0165	0.125	10
	20	1	632010	SH201T-B20	2CDS231001R0205	0.125	10
	25	1	632034	SH201T-B25	2CDS231001R0255	0.125	10
	32	1	632058	SH201T-B32	2CDS231001R0325	0.125	10
	40	1	632072	SH201T-B40	2CDS231001R0405	0.125	10
1+N	6	2	632096	SH201T-B6NA	2CDS231103R0065	0.25	5
	10	2	632126	SH201T-B10NA	2CDS231103R0105	0.25	5
	13	2	632140	SH201T-B13NA	2CDS231103R0135	0.25	5
	16	2	632164	SH201T-B16NA	2CDS231103R0165	0.25	5
	20	2	632188	SH201T-B20NA	2CDS231103R0205	0.25	5
	25	2	632201	SH201T-B25NA	2CDS231103R0255	0.25	5
	32	2	632225	SH201T-B32NA	2CDS231103R0325	0.25	5
	40	2	632249	SH201T-B40NA	2CDS231103R0405	0.25	5
2	6	2	632263	SH202T-B6	2CDS232001R0065	0.25	5
	10	2	632294	SH202T-B10	2CDS232001R0105	0.25	5
	13	2	632317	SH202T-B13	2CDS232001R0135	0.25	5
	16	2	632331	SH202T-B16	2CDS232001R0165	0.25	5
	20	2	632355	SH202T-B20	2CDS232001R0205	0.25	5
	25	2	632379	SH202T-B25	2CDS232001R0255	0.25	5
	32	2	632393	SH202T-B32	2CDS232001R0325	0.25	5
	40	2	632416	SH202T-B40	2CDS232001R0405	0.25	5
3	6	3	632430	SH203T-B6	2CDS233001R0065	0.375	1
	10	3	632461	SH203T-B10	2CDS233001R0105	0.375	1
	13	3	632485	SH203T-B13	2CDS233001R0135	0.375	1
	16	3	632508	SH203T-B16	2CDS233001R0165	0.375	1
	20	3	632522	SH203T-B20	2CDS233001R0205	0.375	1
	25	3	632546	SH203T-B25	2CDS233001R0255	0.375	1
	32	3	632560	SH203T-B32	2CDS233001R0325	0.375	1
	40	3	632584	SH203T-B40	2CDS233001R0405	0.375	1



2CSC400330F007

SH203T-B...NA



2CSC400330F008

SH204T-B

N. of poles	Rated current	N° module	Bbn 4016779	Order details		Price	Weight 1 piece Kg	Pack unit
	In A	[17,5 mm]	EAN	Type code	Order code			
3+N	6	4	632607	SH203T-B6NA	2CDS233103R0065		0.5	1
	10	4	632638	SH203T-B10NA	2CDS233103R0105		0.5	1
	13	4	632652	SH203T-B13NA	2CDS233103R0135		0.5	1
	16	4	632676	SH203T-B16NA	2CDS233103R0165		0.5	1
	20	4	632690	SH203T-B20NA	2CDS233103R0205		0.5	1
	25	4	632713	SH203T-B25NA	2CDS233103R0255		0.5	1
	32	4	632737	SH203T-B32NA	2CDS233103R0325		0.5	1
	40	4	632751	SH203T-B40NA	2CDS233103R0405		0.5	1
4	6	4	632775	SH204T-B6	2CDS234001R0065		0.5	1
	10	4	632805	SH204T-B10	2CDS234001R0105		0.5	1
	13	4	632829	SH204T-B13	2CDS234001R0135		0.5	1
	16	4	632843	SH204T-B16	2CDS234001R0165		0.5	1
	20	4	632867	SH204T-B20	2CDS234001R0205		0.5	1
	25	4	632881	SH204T-B25	2CDS234001R0255		0.5	1
	32	4	632904	SH204T-B32	2CDS234001R0325		0.5	1
	40	4	632928	SH204T-B40	2CDS234001R0405		0.5	1

# Ordering Information

## MCB SH 200 T Series - C characteristic

2



2CSC400030R008

SH201T-C



2CSC400030R010

SH201T-C...NA



2CSC400030R011

SH202T-C



2CSC400030R012

SH203T-C

N. of poles	Rated current	N° module [17,5 mm]	Bbn 4016779	Order details		Price	Weight 1 piece Kg	Pack unit
	In A		EAN	Type code	Order code			
1	6	1	631914	SH201T-C6	2CDS231001R0064		0.125	10
	8	1	631938	SH201T-C8	2CDS231001R0084		0.125	10
	10	1	631945	SH201T-C10	2CDS231001R0104		0.125	10
	13	1	631969	SH201T-C13	2CDS231001R0134		0.125	10
	16	1	631983	SH201T-C16	2CDS231001R0164		0.125	10
	20	1	632003	SH201T-C20	2CDS231001R0204		0.125	10
	25	1	632027	SH201T-C25	2CDS231001R0254		0.125	10
	32	1	632041	SH201T-C32	2CDS231001R0324		0.125	10
	40	1	632065	SH201T-C40	2CDS231001R0404		0.125	10
	1+N	6	2	632089	SH201T-C6NA	2CDS231103R0064		0.25
8		2	632102	SH201T-C8NA	2CDS231103R0084		0.25	5
10		2	632119	SH201T-C10NA	2CDS231103R0104		0.25	5
13		2	632133	SH201T-C13NA	2CDS231103R0134		0.25	5
16		2	632157	SH201T-C16NA	2CDS231103R0164		0.25	5
20		2	632171	SH201T-C20NA	2CDS231103R0204		0.25	5
25		2	632195	SH201T-C25NA	2CDS231103R0254		0.25	5
32		2	632218	SH201T-C32NA	2CDS231103R0324		0.25	5
40		2	632232	SH201T-C40NA	2CDS231103R0404		0.25	5
2		6	2	632256	SH202T-C6	2CDS232001R0064		0.25
	8	2	632270	SH202T-C8	2CDS232001R0084		0.25	5
	10	2	632287	SH202T-C10	2CDS232001R0104		0.25	5
	13	2	632300	SH202T-C13	2CDS232001R0134		0.25	5
	16	2	632324	SH202T-C16	2CDS232001R0164		0.25	5
	20	2	632348	SH202T-C20	2CDS232001R0204		0.25	5
	25	2	632362	SH202T-C25	2CDS232001R0254		0.25	5
	32	2	632386	SH202T-C32	2CDS232001R0324		0.25	5
	40	2	632409	SH202T-C40	2CDS232001R0404		0.25	5
	3	6	3	632423	SH203T-C6	2CDS233001R0064		0.375
8		3	632447	SH203T-C8	2CDS233001R0084		0.375	1
10		3	632454	SH203T-C10	2CDS233001R0104		0.375	1
13		3	632478	SH203T-C13	2CDS233001R0134		0.375	1
16		3	632492	SH203T-C16	2CDS233001R0164		0.375	1
20		3	632515	SH203T-C20	2CDS233001R0204		0.375	1
25		3	632539	SH203T-C25	2CDS233001R0254		0.375	1
32		3	632553	SH203T-C32	2CDS233001R0324		0.375	1
40		3	632577	SH203T-C40	2CDS233001R0404		0.375	1



2CSC400030R0013

SH203T-C...NA



2CSC400030R0014

SH204T-C

N. of poles	Rated current	N° module	Bbn 4016779	Order details		Price	Weight 1 piece Kg	Pack unit
	In A	[17,5 mm]	EAN	Type code	Order code			
3+N	6	4	632591	SH203T-C6NA	2CDS233103R0064		0.5	1
	8	4	632614	SH203T-C8NA	2CDS233103R0084		0.5	1
	10	4	632621	SH203T-C10NA	2CDS233103R0104		0.5	1
	13	4	632645	SH203T-C13NA	2CDS233103R0134		0.5	1
	16	4	632669	SH203T-C16NA	2CDS233103R0164		0.5	1
	20	4	632683	SH203T-C20NA	2CDS233103R0204		0.5	1
	25	4	632706	SH203T-C25NA	2CDS233103R0254		0.5	1
	32	4	632720	SH203T-C32NA	2CDS233103R0324		0.5	1
	40	4	632744	SH203T-C40NA	2CDS233103R0404		0.5	1
	4	6	4	632768	SH204T-C6	2CDS234001R0064		0.5
8		4	632782	SH204T-C8	2CDS234001R0084		0.5	1
10		4	632799	SH204T-C10	2CDS234001R0104		0.5	1
13		4	632812	SH204T-C13	2CDS234001R0134		0.5	1
16		4	632836	SH204T-C16	2CDS234001R0164		0.5	1
20		4	632850	SH204T-C20	2CDS234001R0204		0.5	1
25		4	632874	SH204T-C25	2CDS234001R0254		0.5	1
32		4	632898	SH204T-C32	2CDS234001R0324		0.5	1
40		4	632911	SH204T-C40	2CDS234001R0404		0.5	1



# Ordering Information

## MCB SH 200 L Series - B characteristic

2



2CSC400030P0015

SH201L-B



2CSC400030P0016

SH201L-B...NA



2CSC400030P0017

SH202L-B



2CSC400030P0018

SH203L-B

N. of poles	Rated current	N° module [17,5 mm]	Bbn 4016779	Order details		Price	Weight 1 piece Kg	Pack unit
	In A		EAN	Type code	Order code			
1	6	1	632942	SH201L-B6	2CDS241001R0065		0.125	10
	10	1	632973	SH201L-B10	2CDS241001R0105		0.125	10
	13	1	632997	SH201L-B13	2CDS241001R0135		0.125	10
	16	1	633017	SH201L-B16	2CDS241001R0165		0.125	10
	20	1	633031	SH201L-B20	2CDS241001R0205		0.125	10
	25	1	633055	SH201L-B25	2CDS241001R0255		0.125	10
	32	1	633079	SH201L-B32	2CDS241001R0325		0.125	10
	40	1	633093	SH201L-B40	2CDS241001R0405		0.125	10
	1+N	6	2	633116	SH201L-B6NA	2CDS241103R0065		0.25
10		2	633147	SH201L-B10NA	2CDS241103R0105		0.25	5
13		2	633161	SH201L-B13NA	2CDS241103R0135		0.25	5
16		2	633185	SH201L-B16NA	2CDS241103R0165		0.25	5
20		2	633208	SH201L-B20NA	2CDS241103R0205		0.25	5
25		2	633222	SH201L-B25NA	2CDS241103R0255		0.25	5
32		2	633246	SH201L-B32NA	2CDS241103R0325		0.25	5
40		2	633260	SH201L-B40NA	2CDS241103R0405		0.25	5
2		6	2	633284	SH202L-B6	2CDS242001R0065		0.25
	10	2	633314	SH202L-B10	2CDS242001R0105		0.25	5
	13	2	633338	SH202L-B13	2CDS242001R0135		0.25	5
	16	2	633352	SH202L-B16	2CDS242001R0165		0.25	5
	20	2	633376	SH202L-B20	2CDS242001R0205		0.25	5
	25	2	633390	SH202L-B25	2CDS242001R0255		0.25	5
	32	2	633413	SH202L-B32	2CDS242001R0325		0.25	5
	40	2	633437	SH202L-B40	2CDS242001R0405		0.25	5
	3	6	3	633451	SH203L-B6	2CDS243001R0065		0.375
10		3	633482	SH203L-B10	2CDS243001R0105		0.375	1
13		3	633505	SH203L-B13	2CDS243001R0135		0.375	1
16		3	633529	SH203L-B16	2CDS243001R0165		0.375	1
20		3	633543	SH203L-B20	2CDS243001R0205		0.375	1
25		3	633567	SH203L-B25	2CDS243001R0255		0.375	1
32		3	633581	SH203L-B32	2CDS243001R0325		0.375	1
40		3	633604	SH203L-B40	2CDS243001R0405		0.375	1



2CSC400030F0019

SH203L-B...NA



2CSC400030F0020

SH204L-B

N. of poles	Rated current	N° module	Bbn 4016779	Order details		Price	Weight 1 piece Kg	Pack unit
	In A	[17,5 mm]	EAN	Type code	Order code			
3+N	6	4	633628	SH203L-B6NA	2CDS243103R0065		0.5	1
	10	4	633659	SH203L-B10NA	2CDS243103R0105		0.5	1
	13	4	633673	SH203L-B13NA	2CDS243103R0135		0.5	1
	16	4	633697	SH203L-B16NA	2CDS243103R0165		0.5	1
	20	4	633710	SH203L-B20NA	2CDS243103R0205		0.5	1
	25	4	633734	SH203L-B25NA	2CDS243103R0255		0.5	1
	32	4	633758	SH203L-B32NA	2CDS243103R0325		0.5	1
	40	4	633772	SH203L-B40NA	2CDS243103R0405		0.5	1
4	6	4	633796	SH204L-B6	2CDS244001R0065		0.5	1
	10	4	633826	SH204L-B10	2CDS244001R0105		0.5	1
	13	4	633840	SH204L-B13	2CDS244001R0135		0.5	1
	16	4	633864	SH204L-B16	2CDS244001R0165		0.5	1
	20	4	633888	SH204L-B20	2CDS244001R0205		0.5	1
	25	4	633901	SH204L-B25	2CDS244001R0255		0.5	1
	32	4	633925	SH204L-B32	2CDS244001R0325		0.5	1
	40	4	633949	SH204L-B40	2CDS244001R0405		0.5	1

# Ordering Information

## MCB SH 200 L Series - C characteristic

2



2CSC400030R0021

SH201L-C



2CSC400030R0022

SH201L-C...NA



2CSC400030R0023

SH202L-C



2CSC400030R0024

SH203L-C

N. of poles	Rated current	N° module [17,5 mm]	Bbn 4016779	Order details		Price	Weight 1 piece Kg	Pack unit
	In A		EAN	Type code	Order code			
1	6	1	632935	SH201L-C6	2CDS241001R0064		0.125	10
	8	1	632959	SH201L-C8	2CDS241001R0084		0.125	10
	10	1	632966	SH201L-C10	2CDS241001R0104		0.125	10
	13	1	632980	SH201L-C13	2CDS241001R0134		0.125	10
	16	1	633000	SH201L-C16	2CDS241001R0164		0.125	10
	20	1	633024	SH201L-C20	2CDS241001R0204		0.125	10
	25	1	633048	SH201L-C25	2CDS241001R0254		0.125	10
	32	1	633062	SH201L-C32	2CDS241001R0324		0.125	10
	40	1	633086	SH201L-C40	2CDS241001R0404		0.125	10
	1+N	6	2	633109	SH201L-C6NA	2CDS241103R0064		0.25
8		2	633123	SH201L-C8NA	2CDS241103R0084		0.25	5
10		2	633130	SH201L-C10NA	2CDS241103R0104		0.25	5
13		2	633154	SH201L-C13NA	2CDS241103R0134		0.25	5
16		2	633178	SH201L-C16NA	2CDS241103R0164		0.25	5
20		2	633192	SH201L-C20NA	2CDS241103R0204		0.25	5
25		2	633215	SH201L-C25NA	2CDS241103R0254		0.25	5
32		2	633239	SH201L-C32NA	2CDS241103R0324		0.25	5
40		2	633253	SH201L-C40NA	2CDS241103R0404		0.25	5
2		6	2	633277	SH202L-C6	2CDS242001R0064		0.25
	8	2	633291	SH202L-C8	2CDS242001R0084		0.25	5
	10	2	633307	SH202L-C10	2CDS242001R0104		0.25	5
	13	2	633321	SH202L-C13	2CDS242001R0134		0.25	5
	16	2	633345	SH202L-C16	2CDS242001R0164		0.25	5
	20	2	633369	SH202L-C20	2CDS242001R0204		0.25	5
	25	2	633383	SH202L-C25	2CDS242001R0254		0.25	5
	32	2	633406	SH202L-C32	2CDS242001R0324		0.25	5
	40	2	633420	SH202L-C40	2CDS242001R0404		0.25	5
	3	6	3	633444	SH203L-C6	2CDS243001R0064		0.375
8		3	633468	SH203L-C8	2CDS243001R0084		0.375	1
10		3	633475	SH203L-C10	2CDS243001R0104		0.375	1
13		3	633499	SH203L-C13	2CDS243001R0134		0.375	1
16		3	633512	SH203L-C16	2CDS243001R0164		0.375	1
20		3	633536	SH203L-C20	2CDS243001R0204		0.375	1
25		3	633550	SH203L-C25	2CDS243001R0254		0.375	1
32		3	633574	SH203L-C32	2CDS243001R0324		0.375	1
40		3	633598	SH203L-C40	2CDS243001R0404		0.375	1



2CSC400030F025

SH203L-C...NA



2CSC400030F026

SH204L-C

N. of poles	Rated current	N° module	Bbn 4016779	Order details		Price	Weight 1 piece Kg	Pack unit
	In A	[17,5 mm]	EAN	Type code	Order code			
3+N	6	4	633611	SH203L-C6NA	2CDS243103R0064		0.5	1
	8	4	633635	SH203L-C8NA	2CDS243103R0084		0.5	1
	10	4	633642	SH203L-C10NA	2CDS243103R0104		0.5	1
	13	4	633666	SH203L-C13NA	2CDS243103R0134		0.5	1
	16	4	633680	SH203L-C16NA	2CDS243103R0164		0.5	1
	20	4	633703	SH203L-C20NA	2CDS243103R0204		0.5	1
	25	4	633727	SH203L-C25NA	2CDS243103R0254		0.5	1
	32	4	633741	SH203L-C32NA	2CDS243103R0324		0.5	1
	40	4	633765	SH203L-C40NA	2CDS243103R0404		0.5	1
	4	6	4	633789	SH204L-C6	2CDS244001R0064		0.5
8		4	633802	SH204L-C8	2CDS244001R0084		0.5	1
10		4	633819	SH204L-C10	2CDS244001R0104		0.5	1
13		4	633833	SH204L-C13	2CDS244001R0134		0.5	1
16		4	633857	SH204L-C16	2CDS244001R0164		0.5	1
20		4	633871	SH204L-C20	2CDS244001R0204		0.5	1
25		4	633895	SH204L-C25	2CDS244001R0254		0.5	1
32		4	633918	SH204L-C32	2CDS244001R0324		0.5	1
40		4	633932	SH204L-C40	2CDS244001R0404		0.5	1

# Ordering Information

## MCB SH 200 Series - B characteristic

2



2CSC400030F0027

SH201-B



2CSC400030F0028

SH201-B...NA



2CSC400030F0029

SH202-B

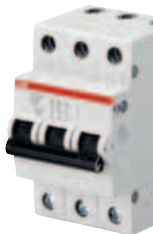

2CSC400030F0030

SH203-B

N. of poles	Rated current	N° module [17,5 mm]	Bbn 4016779	Order details		Price	Weight 1 piece Kg	Pack unit
	In A		EAN	Type code	Order code			
1	6	1	630580	SH201-B6	2CDS211001R0065		0.125	10
	10	1	630610	SH201-B10	2CDS211001R0105		0.125	10
	13	1	630634	SH201-B13	2CDS211001R0135		0.125	10
	16	1	630658	SH201-B16	2CDS211001R0165		0.125	10
	20	1	630672	SH201-B20	2CDS211001R0205		0.125	10
	25	1	630696	SH201-B25	2CDS211001R0255		0.125	10
	32	1	630719	SH201-B32	2CDS211001R0325		0.125	10
	40	1	630733	SH201-B40	2CDS211001R0405		0.125	10
	1+N	6	2	630818	SH201-B6NA	2CDS211103R0065		0.25
10		2	630849	SH201-B10NA	2CDS211103R0105		0.25	5
13		2	630863	SH201-B13NA	2CDS211103R0135		0.25	5
16		2	630887	SH201-B16NA	2CDS211103R0165		0.25	5
20		2	630900	SH201-B20NA	2CDS211103R0205		0.25	5
25		2	630924	SH201-B25NA	2CDS211103R0255		0.25	5
32		2	630948	SH201-B32NA	2CDS211103R0325		0.25	5
40		2	630962	SH201-B40NA	2CDS211103R0405		0.25	5
2		6	2	631044	SH202-B6	2CDS212001R0065		0.25
	10	2	631075	SH202-B10	2CDS212001R0105		0.25	5
	13	2	631099	SH202-B13	2CDS212001R0135		0.25	5
	16	2	631112	SH202-B16	2CDS212001R0165		0.25	5
	20	2	631136	SH202-B20	2CDS212001R0205		0.25	5
	25	2	631150	SH202-B25	2CDS212001R0255		0.25	5
	32	2	631174	SH202-B32	2CDS212001R0325		0.25	5
	40	2	631198	SH202-B40	2CDS212001R0405		0.25	5
	3	6	3	631273	SH203-B6	2CDS213001R0065		0.375
10		3	631303	SH203-B10	2CDS213001R0105		0.375	1
13		3	631327	SH203-B13	2CDS213001R0135		0.375	1
16		3	631341	SH203-B16	2CDS213001R0165		0.375	1
20		3	631365	SH203-B20	2CDS213001R0205		0.375	1
25		3	631389	SH203-B25	2CDS213001R0255		0.375	1
32		3	631402	SH203-B32	2CDS213001R0325		0.375	1
40		3	631426	SH203-B40	2CDS213001R0405		0.375	1





2CSC400030R0031

SH203-B...NA



2CSC400030R0032

SH204-B

N. of poles	Rated current	N° module	Bbn 4016779	Order details		Price	Weight 1 piece Kg	Pack unit
	In A	[17,5 mm]	EAN	Type code	Order code			
3+N	6	4	631501	SH203-B6NA	2CDS213103R0065		0.5	1
	10	4	631532	SH203-B10NA	2CDS213103R0105		0.5	1
	13	4	631556	SH203-B13NA	2CDS213103R0135		0.5	1
	16	4	631570	SH203-B16NA	2CDS213103R0165		0.5	1
	20	4	631594	SH203-B20NA	2CDS213103R0205		0.5	1
	25	4	631617	SH203-B25NA	2CDS213103R0255		0.5	1
	32	4	631631	SH203-B32NA	2CDS213103R0325		0.5	1
	40	4	631655	SH203-B40NA	2CDS213103R0405		0.5	1
4	6	4	631730	SH204-B6	2CDS214001R0065		0.5	1
	10	4	631761	SH204-B10	2CDS214001R0105		0.5	1
	13	4	631785	SH204-B13	2CDS214001R0135		0.5	1
	16	4	631808	SH204-B16	2CDS214001R0165		0.5	1
	20	4	631822	SH204-B20	2CDS214001R0205		0.5	1
	25	4	631846	SH204-B25	2CDS214001R0255		0.5	1
	32	4	631860	SH204-B32	2CDS214001R0325		0.5	1
	40	4	631884	SH204-B40	2CDS214001R0405		0.5	1

# Ordering Information

## MCB SH 200 Series - C characteristic

2



SH201-C

2CSC400030F0033



SH201-C...NA

2CSC400030F0034



SH202-C

2CSC400030F0035



SH203-C

2CSC400030F0036

N. of poles	Rated current	N° module [17,5 mm]	Bbn 4016779	Order details		Price	Weight 1 piece Kg	Pack unit
	In A		EAN	Type code	Order code			
1	6	1	630573	SH201-C6	2CDS211001R0064		0.125	10
	8	1	630597	SH201-C8	2CDS211001R0084		0.125	10
	10	1	630603	SH201-C10	2CDS211001R0104		0.125	10
	13	1	630627	SH201-C13	2CDS211001R0134		0.125	10
	16	1	630641	SH201-C16	2CDS211001R0164		0.125	10
	20	1	630665	SH201-C20	2CDS211001R0204		0.125	10
	25	1	630689	SH201-C25	2CDS211001R0254		0.125	10
	32	1	630702	SH201-C32	2CDS211001R0324		0.125	10
	40	1	630726	SH201-C40	2CDS211001R0404		0.125	10
	1+N	6	2	630801	SH201-C6NA	2CDS211103R0064		0.25
8		2	630825	SH201-C8NA	2CDS211103R0084		0.25	5
10		2	630832	SH201-C10NA	2CDS211103R0104		0.25	5
13		2	630856	SH201-C13NA	2CDS211103R0134		0.25	5
16		2	630870	SH201-C16NA	2CDS211103R0164		0.25	5
20		2	630894	SH201-C20NA	2CDS211103R0204		0.25	5
25		2	630917	SH201-C25NA	2CDS211103R0254		0.25	5
32		2	630931	SH201-C32NA	2CDS211103R0324		0.25	5
40		2	630955	SH201-C40NA	2CDS211103R0404		0.25	5
2		6	2	631037	SH202-C6	2CDS212001R0064		0.25
	8	2	631051	SH202-C8	2CDS212001R0084		0.25	5
	10	2	631068	SH202-C10	2CDS212001R0104		0.25	5
	13	2	631082	SH202-C13	2CDS212001R0134		0.25	5
	16	2	631105	SH202-C16	2CDS212001R0164		0.25	5
	20	2	631129	SH202-C20	2CDS212001R0204		0.25	5
	25	2	631143	SH202-C25	2CDS212001R0254		0.25	5
	32	2	631167	SH202-C32	2CDS212001R0324		0.25	5
	40	2	631181	SH202-C40	2CDS212001R0404		0.25	5
	3	6	3	631266	SH203-C6	2CDS213001R0064		0.375
8		3	631280	SH203-C8	2CDS213001R0084		0.375	1
10		3	631297	SH203-C10	2CDS213001R0104		0.375	1
13		3	631310	SH203-C13	2CDS213001R0134		0.375	1
16		3	631334	SH203-C16	2CDS213001R0164		0.375	1
20		3	631358	SH203-C20	2CDS213001R0204		0.375	1
25		3	631372	SH203-C25	2CDS213001R0254		0.375	1
32		3	631396	SH203-C32	2CDS213001R0324		0.375	1
40		3	631419	SH203-C40	2CDS213001R0404		0.375	1



SH203-C...NA

2CSC400030R0037



SH204-C

2CSC400030R0038

N. of poles	Rated current	N° module	Bbn 4016779	Order details		Price	Weight 1 piece Kg	Pack unit
	In A	[17,5 mm]	EAN	Type code	Order code			
3+N	6	4	631495	SH203-C6NA	2CDS213103R0064		0.5	1
	8	4	631518	SH203-C8NA	2CDS213103R0084		0.5	1
	10	4	631525	SH203-C10NA	2CDS213103R0104		0.5	1
	13	4	631549	SH203-C13NA	2CDS213103R0134		0.5	1
	16	4	631563	SH203-C16NA	2CDS213103R0164		0.5	1
	20	4	631587	SH203-C20NA	2CDS213103R0204		0.5	1
	25	4	631600	SH203-C25NA	2CDS213103R0254		0.5	1
	32	4	631624	SH203-C32NA	2CDS213103R0324		0.5	1
	40	4	631648	SH203-C40NA	2CDS213103R0404		0.5	1
	4	6	4	631723	SH204-C6	2CDS214001R0064		0.5
8		4	631747	SH204-C8	2CDS214001R0084		0.5	1
10		4	631754	SH204-C10	2CDS214001R0104		0.5	1
13		4	631778	SH204-C13	2CDS214001R0134		0.5	1
16		4	631792	SH204-C16	2CDS214001R0164		0.5	1
20		4	631815	SH204-C20	2CDS214001R0204		0.5	1
25		4	631839	SH204-C25	2CDS214001R0254		0.5	1
32		4	631853	SH204-C32	2CDS214001R0324		0.5	1
40		4	631877	SH204-C40	2CDS214001R0404		0.5	1

# Technical details

## Tripping diagrams

2

**B characteristic**

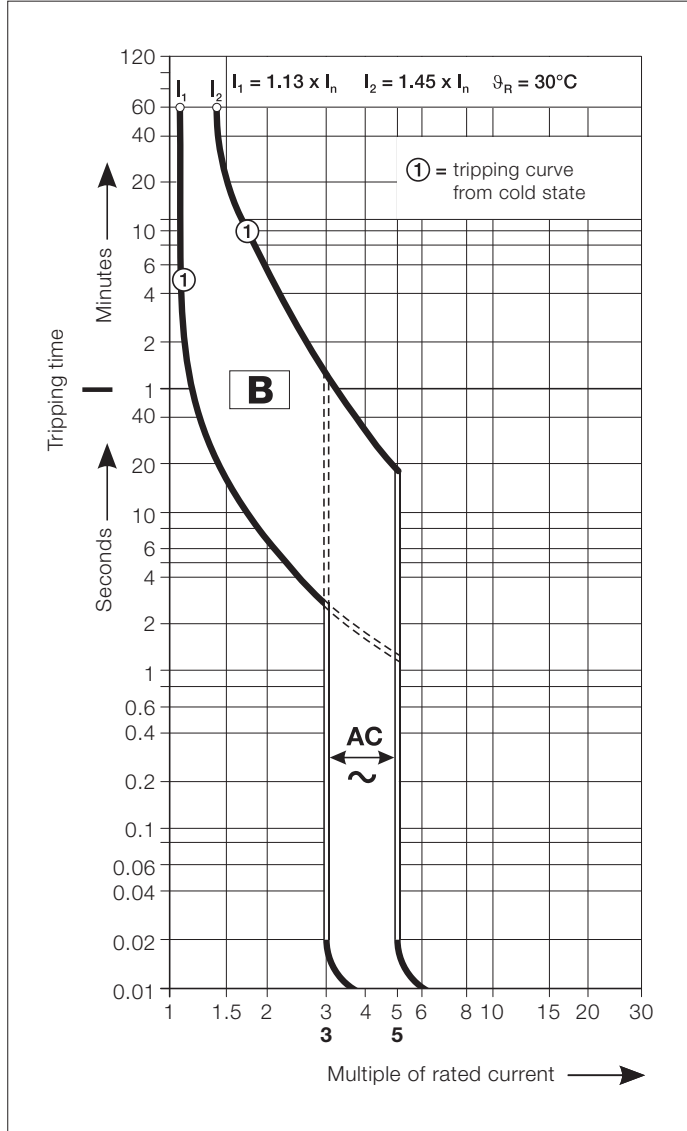

acc. to IEC/EN 60898-1  
 $I_n = 6 \dots 40 \text{ A}$   
 SH 200T / SH 200 L / SH 200

**C characteristic**

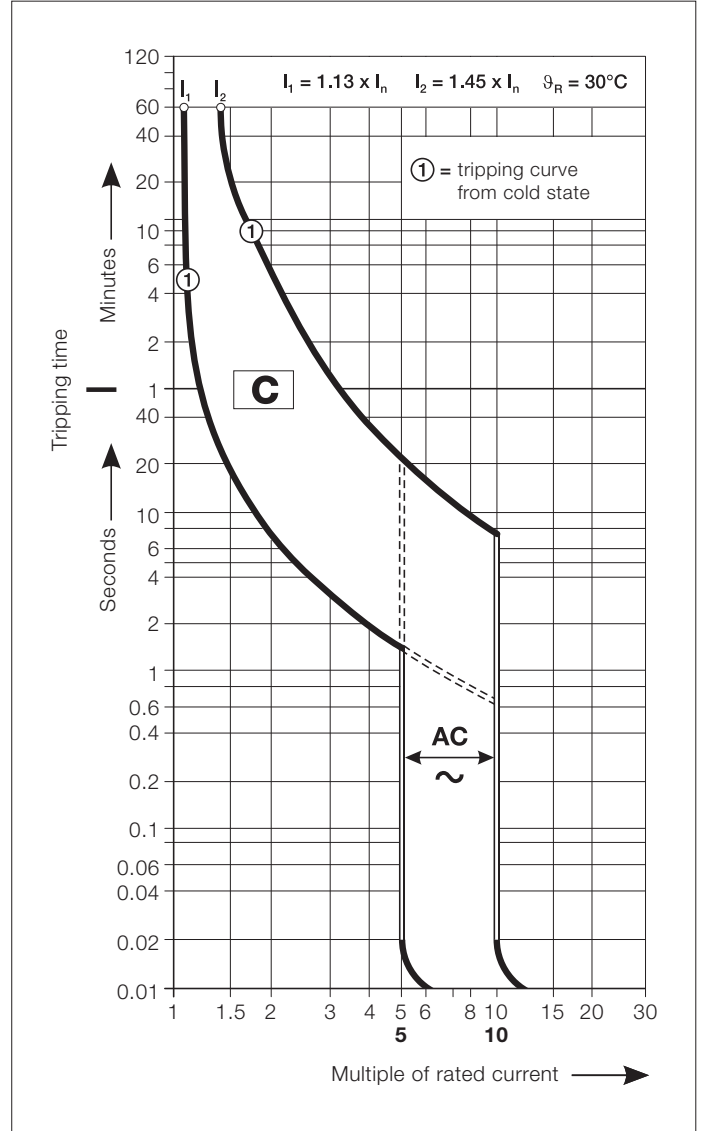

acc. to IEC/EN 60898-1  
 $I_n = 6 \dots 40 \text{ A}$   
 SH 200T / SH 200 L / SH 200

## Internal resistances and power losses of the Miniature Circuit-Breakers

Rated current A	Range SH 200 T B, C		Range SH 200 L B, C		Range SH 200 B, C	
	m Ω	W	m Ω	W	m Ω	W
6	55	2.0	55	2.0	55	2.0
8	15	1.0	15	1.0	15	1.0
10	13.3	1.3	13.3	1.3	13.3	1.3
13	13.3	2.3	13.3	2.3	13.3	2.3
16	7.0	1.8	7.0	1.8	7.0	1.8
20	6.25	2.5	6.25	2.5	6.25	2.5
25	5.0	3.2	5.0	3.2	5.0	3.2
32	3.6	3.7	3.6	3.7	3.6	3.7
40	3.0	4.8	3.0	4.8	3.0	4.8

Internal resistances per pole in m Ω  
Power losses per pole in W

Internal resistances are subject to application-specific and environment-specific conditions and are therefore to be considered as typical values.

## Tripping characteristics

acc. to	Tripping characteristic	Thermal tripping <sup>1</sup>			Electromagnetic tripping <sup>2</sup>		
		Test currents: conventional non-tripping current $I_1$	conventional tripping current $I_2$	Tripping-time	Test currents: conventional non-tripping current	conventional tripping current	Tripping-time
IEC/EN 60898-1	B	$1.13 \cdot I_n$	$1.45 \cdot I_n$	> 1 h < 1 h <sup>3</sup>	$3 \cdot I_n$	$5 \cdot I_n$	0.1 s ... 45 s ≤ 32 A / 0.1 s ... 90 s ≥ 32 A < 0,1 s
	C	$1.13 \cdot I_n$	$1.45 \cdot I_n$	> 1 h < 1 h <sup>3</sup>	$5 \cdot I_n$	$10 \cdot I_n$	0.1 s ... 15 s ≤ 32 A / 0.1 s ... 30 s ≥ 32 A < 0,1 s

<sup>1</sup> Influence of ambient temperature see below.

<sup>2</sup> Electromagnetic tripping valid for AC 50...60 Hz.

<sup>3</sup> From warm operating condition (immediately after  $I_1 > 1h$ ).

## Influence of ambient temperature

The thermal releases are calibrated to a nominal reference temperature of 30°C for B and C characteristic.

In the case of ambient temperatures deviating from these values the trip values:

- are reduced in case of higher temperatures;
- are increased in case of lower temperatures.

**The electromagnetic tripping is independent of the ambient temperature.**



# Technical details

## Current-carrying capacity of the MCBs as a function of the ambient temperature

Max. operating current depending on the ambient temperature of a circuit-breaker in load circuit of characteristics type B and C.

2

B, C In (A)	Ambient temperature T (°C)									
	-30	-20	-10	0	10	20	30	40	50	60
6.0	7.7	7.5	7.2	6.9	6.6	6.3	6.0	5.7	5.3	4.9
8.0	10.3	10.0	9.6	9.2	8.8	8.4	8.0	7.5	7.1	6.5
10.0	12.9	12.5	12.0	11.5	11.1	10.5	10.0	9.4	8.8	8.2
13.0	16.8	16.2	15.6	15.0	14.4	13.7	13.0	12.3	11.5	10.6
16.0	20.7	20.0	19.2	18.5	17.7	16.9	16.0	15.1	14.1	13.1
20.0	25.8	24.9	24.0	23.1	22.1	21.1	20.0	18.9	17.6	16.3
25.0	32.3	31.2	30.0	28.9	27.6	26.4	25.0	23.6	22.0	20.4
32.0	41.3	39.9	38.5	37.0	35.4	33.7	32.0	30.2	28.2	26.1
40.0	51.6	49.9	48.1	46.2	44.2	42.2	40.0	37.7	35.3	32.7

## Mutual thermal influence in the case of simultaneous load

MCBs mounted in a row side by side

MCBs mounted with a separating distance X

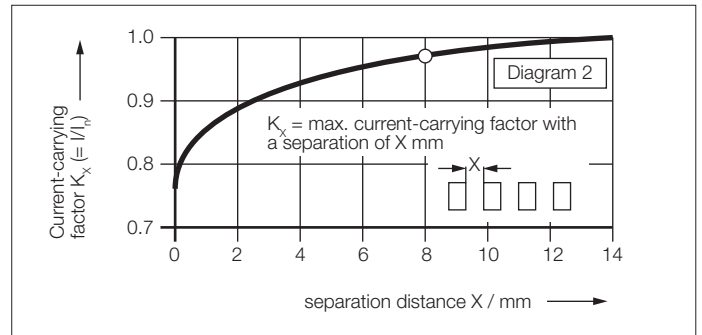
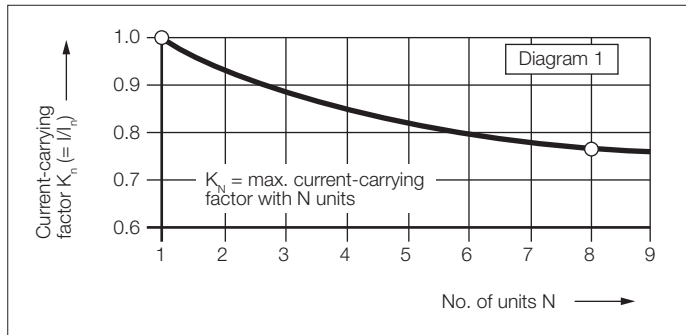

Characteristic	from diagram	Calculation	Example
Rated current and characteristics of MCB		$I_n / B, C$	16 A - B
Continuous load		$\vartheta_{\theta}$	40 °C
Number of MCB's / Mounting distance		$N / X$	8 pieces / 0 and 8 mm
Continuous load > 1 h		$I = I_n \cdot K_{\theta}$	$I_n=16A$
Continuous load, N MCB, Distance 0	1	$I = K_{\theta} \cdot K_N$	incl. derating due to temp. 40°C: $I_n=15.1A$
Continuous load, N MCB, Distance X	2	$I = K_{\theta} \cdot K_X$	$16 \cdot 0.77 = 12.23 A$
			$15.1A \cdot 0.77 = 11.6A$
			$15.1A \cdot 0.98 = 14.8A$

## Max. Back-up protection

SH 200 T / SH 200 L / SH 200	B/C	Max. Back-up protection	
	Rated current	fuse	Main Circuit Breaker S 700
	6/8	63 A	100 A
	10... 32	100 A	100 A
	40	125 A	100 A

## Maximum permissible earth-fault loop impedance $Z_s$

Impedance  $Z_s$  at  $U_0 = 230 \text{ V AC}^1$  to ensure compliance with the operation conditions in accordance to IEC 60 364-4-41.

Operating time  $< 0.4 \text{ s}$ ; at  $400 \text{ V AC} < 0.2 \text{ s}$  and at  $> 400 \text{ V AC} < 0.1 \text{ s}$

The instantaneous tripping of the MCB ensures an operating time of  $\leq 0.1 \text{ s}$  (TN system).

Determined according to DIN VDE 0100-520, supplement 2, 2002-11 (source impedance =  $300 \Omega$ ,  $c = 0.95$  and conductor temperature  $70 \text{ }^\circ\text{C} = \text{factor } 0.8$ ). The internal resistance of the MCB is already included.

### SH 200, SH 200 L, SH 200 T

Rated current $I_n \text{ A}$	B max. $Z_s$ $\Omega$	C max. $Z_s$ $\Omega$
6	7.7	3.8
8	–	2.8
10	4.6	2.2
13	3.5	1.7
16	2.9	1.4
20	2.3	1.2
25	1.8	0.9
32	1.4	0.7
40	1.1	0.6

1)  $U_0$  = rated voltage against earthed conductor; for  $U_0 = 240 \text{ V}$  - is  $Z_s \cdot 1.04$ ; for  $U_0 = 127 \text{ V}$  - is  $Z_s \cdot 0.55$

### Take into account the voltage drop:

e.g. in the case of a  $1.5 \text{ mm}^2$  conductor, protected by a B 16 circuit breaker, the maximum cable length is 82 m.

If the voltage is below 3%, this would result in a maximum cable length (2 wire) of 17 m.

For more details on this topic, get your own copy of the technical information leaflet "Maximum cable lengths".

### Maximum cable length in case of different voltages and cross sections on request.

# Technical details

## Short circuit selectivity

In the case of a short circuit, selectivity exists up to the values indicated.

2

MCBs

short circuit discrimination in kA

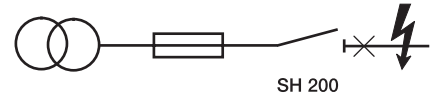
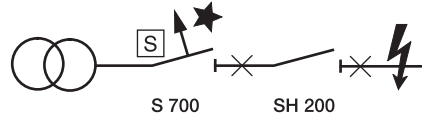

series	I <sub>n</sub> (A)	to main circuit breaker S 700									to fuse gL/gG (IEC 60 269-1)										
		16	20	25	35	40	50	63	80	100	16	20	25	35	50	63	80	100	125	160	
SH 200 T – B, C	6	4.5	4.5	4.5	4.5	4.5	4.5	4.5	4.5	4.5	0.2	0.4	0.6	1.5	2.5	2.8	3	3	3	3	
	8	4.5	4.5	4.5	4.5	4.5	4.5	4.5	4.5	4.5		0.3	0.6	1.4	2.4	2.6	3	3	3	3	
	10	4.5	4.5	4.5	4.5	4.5	4.5	4.5	4.5	4.5			0.5	1.2	2.1	2.5	2.8	3	3	3	
	13	4.5	4.5	4.5	4.5	4.5	4.5	4.5	4.5	4.5			0.4	1.0	1.8	2.4	2.8	3	3	3	
	16	4.5	4.5	4.5	4.5	4.5	4.5	4.5	4.5	4.5				0.8	1.6	2.3	2.8	3	3	3	
	20		4.5	4.5	4.5	4.5	4.5	4.5	4.5	4.5					1.5	2.1	2.5	2.5	3	3	
	25			4.5	4.5	4.5	4.5	4.5	4.5	4.5					1.0	2.0	2.5	2.5	3	3	
	32		**		4.5	4.5	4.5	4.5	4.5	4.5							1.9	2.5	2.5	3	3
	40					4.5	4.5	4.5	4.5	4.5							1.5	2	2	2	2
	SH 200 L – B, C	6	6	6	6	6	6	6	6	6	6	0.2	0.4	0.7	1.8	3	5	4.5	4.5	4.5	4.5
8		6	6	6	6	6	6	6	6	6	0.2	0.3	0.6	0.6	2.5	4	4.5	4.5	4.5	4.5	
10		6	6	6	6	6	6	6	6	6		0.3	0.6	1.4	2.3	3	4	4.5	4.5	4.5	
13		6	6	6	6	6	6	6	6	6			0.5	1.3	2	3	4	4.5	4.5	4.5	
16		6	6	6	6	6	6	6	6	6				1	1.8	2.5	3.5	4.5	4.5	4.5	
20			6	6	6	6	6	6	6	6					1.6	2.2	3	4	4.5	4.5	
25				6	6	6	6	6	6	6					1.5	2.2	3	4	4.5	4.5	
32			**		6	6	6	6	6	6							2	2.8	3.5	4.5	4.5
40						6	6	6	6	6							2	2.5	3	4.5	4.5
SH 200 – B, C		6	10	10	10	10	10	10	10	8	8	0.2	0.5	0.8	2	3.3	5.5	6	6	6	6
	8	10	10	10	10	10	10	10	8	8	0.2	0.4	0.7	1.7	2.8	4.5	6	6	6	6	
	10	10	10	10	10	10	10	10	8	8	0.2	0.4	0.7	1.5	2.5	3.5	5	6	6	6	
	16	10	10	10	10	10	10	10	8	8			0.7	1.5	2.5	3.5	5	6	6	6	
	20		10	10	10	10	10	10	8	8				1.3	2	2.9	4.1	6	6	6	
	25			10	10	10	15	10	8	8					1.8	2.6	3.5	5	6	6	
	32		**		10	10	10	10	8	8					1.8	2.6	3.5	5	6	6	
	40					10	10	10	8	8					2.2	3	4	6	6	6	

\*\* Limited or no selectivity at all possible in the overload range (thermal tripping)

# Overall dimensions

SH 200, SH 200 L, SH 200 T

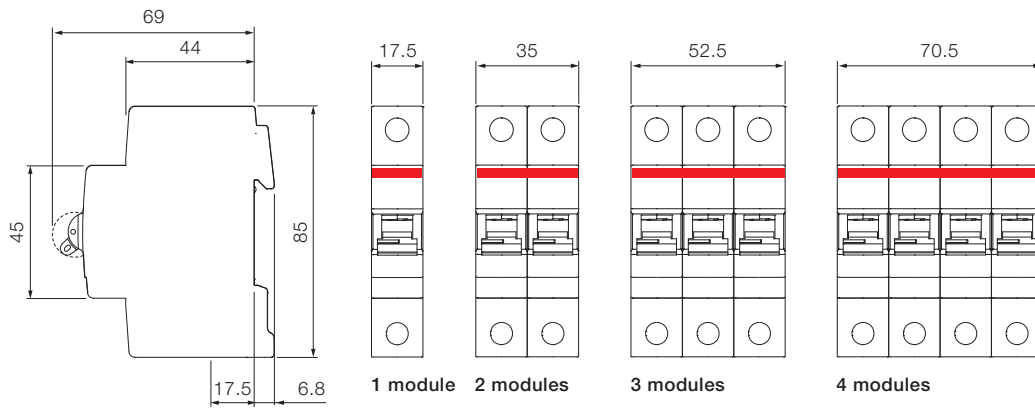





# Residual current devices

## FH200

Plus of range	2/30
Technical features table	2/32
Ordering information	2/34
Technical details	2/37

## DS201 and DS202C

Plus of range	2/38
Technical features table	2/40
Ordering information DS201 series	2/42
Ordering information DS202C series	2/49
Technical details	2/50

Overall dimensions	2/54
--------------------	------

# RCCB FH200. The details make the difference

## A range designed to ensure efficiency and protection

2

Test pushbutton to verify the correct functioning of the device.

Bi-directional cylindrical terminals ensure higher safety of wiring operation, making them easier.

Information on the device are laser printed to make them clearly visible and long lasting.

Laser-marked order code on the front to make easier future orders.





Two terminals are available, the fore one for cables up to 25 mm<sup>2</sup>, the back one for cables up to 10 mm<sup>2</sup> or for busbars.



FH200: a wide range of RCCBs with 2P and 4P configuration, rated currents from 25 to 63 A, available in AC and A type with rated sensitivity from 30 mA up to 300 mA.



The availability of two terminals offers different connection solutions thanks to the possibility to connect two independent cables in the same device: the second terminal can be used for an auxiliary circuit or for the supply of devices with small section cables without connecting them together with the main circuit.



All the safety ensured by the international marks: approvals' marking in a visible area, even if RCDs is installed and with the panel-door closed.



High performances:

- rated breaking capacity and rated residual breaking capacity laser printed on the device:  
 $I_m = I_{\Delta m} = 1000 \text{ A}$
- coordination with a 63 A rated current SCPD (short-circuit protective device) = 6000 A.



The FH202 can be coupled with the autoreclosing unit F2C-ARH in order to ensure continuity of service for the whole installation of your home avoiding lack of supply.

# Technical features table for residual current circuit breakers (RCCBs) FH200 Series

2

Standards			
<b>Electrical features</b>			
Type (wave form of the earth leakage sensed)			
Poles			
Rated current $I_n$			A
Rated sensitivity $I_{\Delta n}$			mA
Rated voltage $U_e$			V
Insulation voltage $U_i$			V
Max. operating voltage of circuit test			V
Min. operating voltage of circuit test			V
Rated frequency			Hz
Rated conditional short-circuit current $I_{nc}=I_{\Delta c}$			kA
Rated residual breaking capacity $I_{\Delta m}=I_m$			kA
Rated impulse withstand voltage (1.2/50) $U_{imp}$			kV
Dielectric test voltage at ind. freq. for 1 min.			kV
Surge current resistance (wave 8/20)			A
<b>Mechanical features</b>			
Toggle			
Contact position indicator (CPI)			
Electrical life			
Mechanical life			
Protection degree	housing		
	terminals		
Tropicalization acc. to IEC/EN 60068-2	humid heat		°C/RH
	constant climatic conditions		°C/RH
	variable climatic conditions		°C/RH
Ambient temperature (with daily average $\leq +35$ °C)			°C
Storage temperature			°C
<b>Installation</b>			
Terminal type			
Terminal size top/bottom for cable			mm <sup>2</sup>
Terminal size top/bottom for busbar			mm <sup>2</sup>
Tightening torque			N*m
Tool			
Mounting			
Connection			
<b>Dimensions and weight</b>			
Dimensions (H x D x W)	2P		mm
	4P		mm
Weight	2P		g
	4P		g
<b>Combination with auxiliary elements</b>			
Combinable with:	F2C-ARH autoreclosing unit		



2CSC400030F0039



2CSC400030F0044

**FH200**

**F200**

IEC/EN 61008

AC	A	A S
2P, 4P		2P, 4P
25, 40, 63		40, 63
30, 100, 300	30	300
230/400 - 240/415		230/400 - 240/415
500		500
254		254
110		110
50..60		50..60
6 (with a SCPD-fuse gG 63A )		10 (with a SCPD-fuse gG 100A )
1		1
4		4
2.5		2.5
250		5000
BLACK sealable in ON-OFF position not available		BLUE sealable in ON-OFF position yes
10.000		10.000
20.000		20.000
IP4X		IP4X
IP2X		IP2X
28 cycles with 55/95...100		28 cycles with 55/95...100
23/83 - 40/93 - 55/20		23/83 - 40/93 - 55/20
25/95 - 40/95		25/95 - 40/95
-5..+40		-25..+55
-40...+70		-40...+70
failsafe bi-directional cylinder-lift terminal at top and bottom (shock protected)		failsafe bi-directional cylinder-lift terminal at top and bottom (shock protected)
25/25		25/25
10/10		10/10
2.8		2.8
Nr. 2 Pozidriv		Nr. 2 Pozidriv
on DIN rail EN 60715 (35 mm) by means of fast clip device from top and bottom		on DIN rail EN 60715 (35 mm) by means of fast clip device from top and bottom
85 x 69 x 35		85 x 69 x 35
85 x 69 x 70		85 x 69 x 70
200		200
350		350
yes (the 2 poles version 30mA and 100mA)		no

# Ordering Information

## FH200 - AC type

2



2CSC400030R1630

FH202 AC



2CSC400030R16041

FH204 AC

**Function:** protection against the effects of sinusoidal alternating earth fault currents; protection against indirect contacts and additional protection against direct (with  $I_{\Delta n}=30$  mA) contacts.

**Standard:** IEC/ EN 61008

**Marking:** according to EN 61008

N. of poles	Rated residual current	Rated current	N° module	Bbn 8012542	Order details		Price	Weight 1 piece Kg	Pack unit
	$I_{\Delta n}$ mA	In A	[17,5 mm]	EAN	Type code	Order code			
2	30	25	2	891802	FH202 AC-25/0.03	2CSF202002R1250		0.225	1/6
		40	2	891901	FH202 AC-40/0.03	2CSF202002R1400		0.225	1/6
		63	2	892007	FH202 AC-63/0.03	2CSF202002R1630		0.225	1/6
	300	25	2	893004	FH202 AC-25/0.3	2CSF202003R3250		0.225	1/6
		40	2	893103	FH202 AC-40/0.3	2CSF202003R3400		0.225	1/6
		63	2	893202	FH202 AC-63/0.3	2CSF202003R3630		0.225	1/6
4	30	25	4	892106	FH204 AC-25/0.03	2CSF204002R1250		0.375	1/3
		40	4	892205	FH204 AC-40/0.03	2CSF204002R1400		0.375	1/3
		63	4	892304	FH204 AC-63/0.03	2CSF204002R1630		0.375	1/3
	300	25	4	893301	FH204 AC-25/0.3	2CSF204003R3250		0.375	1/3
		40	4	893400	FH204 AC-40/0.3	2CSF204003R3400		0.375	1/3
		63	4	893509	FH204 AC-63/0.3	2CSF204003R3630		0.375	1/3



# Ordering Information

## FH200 - AC type (for overseas markets)



FH202 AC



FH204 AC

**Function:** protection against the effects of sinusoidal alternating earth fault currents; protection against indirect contacts and additional protection against direct (with  $I_{\Delta n}=30$  mA) contacts.

**Standard:** IEC/ EN 61008

**Marking:** according to IEC 61008

N. of poles	Rated residual current	Rated current	N° module	Bbn	Order details		Price	Weight 1 piece	Pack unit
	$I_{\Delta n}$ mA	In A	[17,5 mm]	8012542	Type code	Order code			
2	30	25	2	894209	FH202 AC-25/0.03	2CSF202006R1250		0.225	1/6
		40	2	894308	FH202 AC-40/0.03	2CSF202006R1400		0.225	1/6
		63	2	894407	FH202 AC-63/0.03	2CSF202006R1630		0.225	1/6
	100	25	2	894506	FH202 AC-25/0.1	2CSF202006R2250		0.225	1/6
		40	2	894605	FH202 AC-40/0.1	2CSF202006R2400		0.225	1/6
		63	2	894704	FH202 AC-63/0.1	2CSF202006R2630		0.225	1/6
	300	25	2	894803	FH202 AC-25/0.3	2CSF202006R3250		0.225	1/6
		40	2	894902	FH202 AC-40/0.3	2CSF202006R3400		0.225	1/6
		63	2	895008	FH202 AC-63/0.3	2CSF202006R3630		0.225	1/6
4	30	25	4	895107	FH204 AC-25/0.03	2CSF204006R1250		0.375	1/3
		40	4	895206	FH204 AC-40/0.03	2CSF204006R1400		0.375	1/3
		63	4	895305	FH204 AC-63/0.03	2CSF204006R1630		0.375	1/3
	100	25	4	895404	FH204 AC-25/0.1	2CSF204006R2250		0.375	1/3
		40	4	895503	FH204 AC-40/0.1	2CSF204006R2400		0.375	1/3
		63	4	895602	FH204 AC-63/0.1	2CSF204006R2630		0.375	1/3
	300	25	4	895701	FH204 AC-25/0.3	2CSF204006R3250		0.375	1/3
		40	4	895800	FH204 AC-40/0.3	2CSF204006R3400		0.375	1/3
		63	4	895909	FH204 AC-63/0.3	2CSF204006R3630		0.375	1/3

# Ordering Information

## FH200 A type - F200 A S type

2



FH202 A



FH204 A

### FH200 A type

**Function:** protection against the effects of sinusoidal alternating and direct pulsating earth fault currents; protection against indirect contacts and additional protection against direct (with  $I_{\Delta n}=30$  mA) contacts.

**Standard:** IEC/ EN 61008

**Marking:** according to EN 61008

N. of poles	Rated residual current		N° module	Bbn 8012542		Order details		Price	Weight 1 piece	Pack unit
	$I_{\Delta n}$ mA	In A		[17,5 mm]	EAN	Type code	Order code			
2	30	25	2	892403	FH202 A-25/0.03	2CSF202102R1250		0.225	1/6	
		40	2	892502	FH202 A-40/0.03	2CSF202102R1400		0.225	1/6	
		63	2	892601	FH202 A-63/0.03	2CSF202102R1630		0.225	1/6	
4	30	25	4	892700	FH204 A-25/0.03	2CSF204102R1250		0.375	1/3	
		40	4	892809	FH204 A-40/0.03	2CSF204102R1400		0.375	1/3	
		63	4	892908	FH204 A-63/0.03	2CSF204102R1630		0.375	1/3	

### F200 A S type

**Function:** protection against the effects of sinusoidal alternating and direct pulsating earth fault currents with an intentional tripping delay, which permits to realize the selectivity with downstream instantaneous devices; protection against indirect contacts.

**Standard:** IEC/EN 61008

**Marking:** according to EN 61008



F202 A S



F204 A S

N. of poles	Rated residual current		N° module	Bbn 8012542		Order details		Price	Weight 1 piece	Pack unit
	$I_{\Delta n}$ mA	In A		[17,5 mm]	EAN	Type code	Order code			
2	300	40	2	784302	F202 A S-40/0.3	2CSF202201R3400		0.225	1/6	
		63	2	784401	F202 A S-63/0.3	2CSF202201R3630		0.225	1/6	
4	300	40	4	784708	F204 A S-40/0.3	2CSF204201R3400		0.375	1/3	
		63	4	784807	F204 A S-63/0.3	2CSF204201R3630		0.375	1/3	

# Technical details

## Coordination tables

### FH202

	Single-phases 230-240 V circuit		
	25 A	40 A	63 A
SH201 T - SH201 T NA - SH202 T	3	3	3
SH201 L - SH201 L NA - SH202 L	4.5	4.5	4.5
SH201 - SH201 NA - SH202	6	6	6

### FH204

	Three-phases circuits with neutral (y/Δ) 230-240 V/400-415 V		
	25 A	40 A	63 A
SH201 T* - SH201 T NA* - SH202 T*	3	3	3
SH201 L* - SH201 L NA* - SH202 L*	4.5	4.5	4.5
SH201* - SH201 NA* - SH202*	6	6	6

\* The switches are considered between phase and neutral (230/240V)

### FH204

	Three-phases circuits with neutral (y/Δ) 230-240 V/400-415 V		
	25 A	40 A	63 A
SH203 T - SH203 T NA - SH204 T	3	3	3
SH203 L - SH203 L NA - SH204 L	4.5	4.5	4.5
SH203 - SH203 NA - SH204	6	6	6

## Power loss

Rated current In [A]	Power loss W [W]	
	2P	4P
25	1.0	1.3
40	2.4	3.2
63	3.2	4.4

# RCBO DS201 and DS202C. The details make the difference

A range designed to ensure efficiency and protection

2

Information on the device are laser printed to ensure readability over time.

Bi-directional cylindrical terminals ensure higher safety of wiring operations, making them easier.

Label carrier to identify the line the RCBO is protecting.

Each RCBO of the DS201-DS202C range is equipped with an Rfid tag containing a unique serial number assigned to ABB according to the standard ISO/IEC FCD 15693-3 in order to authenticate the product.

Test pushbutton to verify the correct functioning of the device





Any earth fault can be immediately identified through the blue indicator, that signals the differential tripping and which cannot be activated in case of manual operation on the toggle. This prevents any misinterpretations of the device and system status.



Contact position indicator (CPI): to always know the status of the contacts (red: closed contacts; green: open contacts).



The terminals available on DS201-DS202C make easier the supply operation in parallel with busbars as they are composed by two different seats, a front seat for 25 mm² cables and a back seat for 10 mm² busbars.



All the devices of the DS201 and DS202C series have been tested in a wide range of temperatures: from -25 °C (as indicated by the snowflake marked on the front side) up to +55°C.



Label carrier for clear and reliable identification. With the practical label carrier fitted in the new circuit breakers you can give maximum visibility to the information relating to the protected loads.



All the quality ensured by the main international marks is clearly visible on the device even if installed in the switchboard.



Product description and EAN code laser printed on the lateral side of the device for an easier stock management.

# Technical features table for RCBOs DS201 and DS202C Series

2

Standards			
<b>Electrical features</b>			
Type (wave form of the earth leakage sensed)			
Poles			
Rated current $I_n$			A
Rated sensitivity $I_{\Delta n}$			mA
Rated voltage $U_e$			V
Insulation voltage $U_i$			V
Max. operating voltage of circuit test			V
Min. operating voltage of circuit test			V
Rated frequency			Hz
Rated breaking capacity acc. to IEC/EN 61009	ultimate $I_{cn}$		A
Rated residual breaking capacity $I_{\Delta n}$			kA
Rated impulse withstand voltage (1.2/50) $U_{imp}$			kV
Dielectric test voltage at ind. freq. for 1 min.			kV
Thermomagnetic release characteristic	B: $3 I_n \leq I_m \leq 5 I_n$ C: $5 I_n \leq I_m \leq 10 I_n$		
Surge current resistance (wave 8/20)			A
<b>Mechanical features</b>			
Toggle			
Flag indicators			
Electrical life			
Mechanical life			
Protection degree	housing terminals		
Tropicalization acc. to IEC/EN 60068-2	constant climatic conditions variable climatic conditions		°C/RH °C/RH
Reference temperature for setting of thermal element			°C
Ambient temperature (with daily average $\leq +35$ °C)			°C
Storage temperature			°C
<b>Installation</b>			
Terminal type			
Terminal size top/bottom for cables			mm <sup>2</sup>
Terminal size top/bottom for busbar			mm <sup>2</sup>
Tightening torque top/bottom			N*m
Mounting			
Connection			
<b>Dimensions and weight</b>			
Dimensions (H x D x W)			mm
Weight			g
<b>Combination with auxiliary elements</b>			
Combinable with:	auxiliary contact signal contact/auxiliary switch shunt trip undervoltage release		





2CSC400030F0046



2CSC400030F0047



2CSC400030F0048

DS201 L			DS201			DS202C		
IEC / EN 61009								
AC	A	APR	AC	A	APR	A		
1P+N	1P+N	1P+N	1P+N	1P+N	1P+N	1P+N	2P	
6...32	6...32	6...32	6...40	2...40	6...40	6...32	6...32	
30	10, 30, 300	30	30,100	10, 30, 100, 300	30	30	30	
230-240								
500								
254								
110								
50...60								
4500			6000			6000		
4.5			6			6		
4						4		
2.5						2.5		
■	■	■	■	■	■	■	■	
250	250	3000	250	250	3000	250	250	
black sealable in ON-OFF position								
differential trip indicator (blue); contact position indicator (green/red)								
10000								
20000								
IP4X								
IP2X								
23/83 - 40/93 - 55/20								
25/95 - 40/95								
30								
-25...+55								
-40...+70								
failsafe bi-directional cylinder-lift terminal at top and bottom (shock protected)								
25/25								
10/10								
2.8								
on DIN rail EN 60715 (35 mm) by means of fast clip device								
from top and bottom								
85x69x35								
239								
yes								
yes								
yes								
yes								

# Ordering Information

## DS201 L - AC type

2



2CSC400030D0202

DS201 L - AC

**Function:** protection of end user single-phase circuits against overload and short-circuit currents; protection against the effects of sinusoidal alternating earth fault currents; protection against indirect contact and additional protection against direct contact ( $I_{\Delta n}=30$  mA).

**Standard:** IEC/ EN 61009

$I_{cn} = 4500$  A

### C characteristic

N. of poles	Rated residual current		N° module [17,5 mm]	Bbn 8012542 EAN	Order details		Price	Weight 1 piece Kg	Pack unit
	$I_{\Delta n}$ mA	$I_n$ A			Type code	Order code			
1+N	30	6	2	171201	DS201 L C6 AC30	2CSR245040R1064		0.275	5
		10	2	171300	DS201 L C10 AC30	2CSR245040R1104		0.275	5
		16	2	171409	DS201 L C16 AC30	2CSR245040R1164		0.275	5
		20	2	171508	DS201 L C20 AC30	2CSR245040R1204		0.275	5
		25	2	171607	DS201 L C25 AC30	2CSR245040R1254		0.275	5
		32	2	171706	DS201 L C32 AC30	2CSR245040R1324		0.275	5

# Ordering Information

## DS201 L - A type



DS201 L - A

**Function:** protection of end user single-phase circuits against overload and short-circuit currents; protection against the effects of sinusoidal alternating and direct pulsating earth fault currents; protection against indirect contact and additional protection against direct contact ( $I_{\Delta n}=30$  mA).

**Standard:** IEC/ EN 61009

$I_{cn} = 4500$  A

### C characteristic

N. of poles	Rated residual current	Rated current	N° module	Bbn 8012542	Order details		Price	Weight 1 piece Kg	Pack unit
	$I_{\Delta n}$ mA	In A	[17,5 mm]	EAN	Type code	Order code			
1+N	10	6	2	163404	DS201 L C6 A10	2CSR245140R0064		0.275	5
		10	2	171003	DS201 L C10 A10	2CSR245140R0104		0.275	5
		16	2	171102	DS201 L C16 A10	2CSR245140R0164		0.275	5
	30	6	2	172406	DS201 L C6 A30	2CSR245140R1064		0.275	5
		10	2	172505	DS201 L C10 A30	2CSR245140R1104		0.275	5
		16	2	172604	DS201 L C16 A30	2CSR245140R1164		0.275	5
		20	2	172703	DS201 L C20 A30	2CSR245140R1204		0.275	5
		25	2	173809	DS201 L C25 A30	2CSR245140R1254		0.275	5
		32	2	173908	DS201 L C32 A30	2CSR245140R1324		0.275	5
	300	6	2	174004	DS201 L C6 A300	2CSR245140R3064		0.275	5
		10	2	174103	DS201 L C10 A300	2CSR245140R3104		0.275	5
		16	2	174202	DS201 L C16 A300	2CSR245140R3164		0.275	5
		20	2	174301	DS201 L C20 A300	2CSR245140R3204		0.275	5
		25	2	174707	DS201 L C25 A300	2CSR245140R3254		0.275	5
		32	2	174806	DS201 L C32 A300	2CSR245140R3324		0.275	5

# Ordering Information

## DS201 L - APR type

2



DS201 L - APR

**Function:** protection against the effects of sinusoidal alternating and direct pulsating earth fault currents, providing an optimal trade-off between safety and continuity of service, thanks to the resistance to unwanted tripping; protection against indirect contact and additional protection against direct ( $I_{\Delta n}=30\text{mA}$ ) contact; protection and isolation of resistive and inductive loads.

**Standard:** IEC/ EN 61009

$I_{cn} = 4500 \text{ A}$

### C characteristic

N. of poles	Rated residual current		N° module [17,5 mm]	Bbn 8012542 EAN	Order details		Price	Weight 1 piece Kg	Pack unit
	$I_{\Delta n} \text{ mA}$	$I_n \text{ A}$			Type code	Order code			
1+N	30	6	2	174905	DS201 L C6 APR30	2CSR245440R1064		0.275	5
		10	2	175001	DS201 L C10 APR30	2CSR245440R1104		0.275	5
		16	2	175100	DS201 L C16 APR30	2CSR245440R1164		0.275	5
		20	2	175209	DS201 L C20 APR30	2CSR245440R1204		0.275	5
		25	2	175605	DS201 L C25 APR30	2CSR245440R1254		0.275	5
		32	2	175704	DS201 L C32 APR30	2CSR245440R1324		0.275	5

# Ordering Information

## DS201 - AC type



DS201 B - AC



DS201 C - AC

**Function:** protection of end user single-phase circuits against overload and short-circuit currents; protection against the effects of sinusoidal alternating earth fault currents; protection against indirect contact and additional protection against direct contact ( $I_{\Delta n}=30$  mA).

**Standard:** IEC/ EN 61009

$I_{cn} = 6000$  A

### B characteristic

N. of poles	Rated residual current $I_{\Delta n}$ mA	Rated current $I_n$ A	N° module [17,5 mm]	Bbn 8012542 EAN	Order details		Price	Weight 1 piece Kg	Pack unit
					Type code	Order code			
1+N	30	6	2	279709	DS201 B6 AC30	2CSR255040R1065		0.275	5
		10	2	280309	DS201 B10 AC30	2CSR255040R1105		0.275	5
		13	2	285205	DS201 B13 AC30	2CSR255040R1135		0.275	5
		16	2	285304	DS201 B16 AC30	2CSR255040R1165		0.275	5
		20	2	285403	DS201 B20 AC30	2CSR255040R1205		0.275	5
		25	2	285502	DS201 B25 AC30	2CSR255040R1255		0.275	5
		32	2	285601	DS201 B32 AC30	2CSR255040R1325		0.275	5
		40	2	285700	DS201 B40 AC30	2CSR255040R1405		0.275	5
	100	6	2	285809	DS201 B6 AC100	2CSR255040R2065		0.275	5
		10	2	285908	DS201 B10 AC100	2CSR255040R2105		0.275	5
		13	2	286004	DS201 B13 AC100	2CSR255040R2135		0.275	5
		16	2	286103	DS201 B16 AC100	2CSR255040R2165		0.275	5
		20	2	286202	DS201 B20 AC100	2CSR255040R2205		0.275	5
		25	2	286301	DS201 B25 AC100	2CSR255040R2255		0.275	5
		32	2	286400	DS201 B32 AC100	2CSR255040R2325		0.275	5
		40	2	286509	DS201 B40 AC100	2CSR255040R2405		0.275	5

### C characteristic

1+N	30	6	2	294504	DS201 C6 AC30	2CSR255040R1064		0.275	5
		10	2	294603	DS201 C10 AC30	2CSR255040R1104		0.275	5
		13	2	294702	DS201 C13 AC30	2CSR255040R1134		0.275	5
		16	2	294801	DS201 C16 AC30	2CSR255040R1164		0.275	5
		20	2	294900	DS201 C20 AC30	2CSR255040R1204		0.275	5
		25	2	295006	DS201 C25 AC30	2CSR255040R1254		0.275	5
		32	2	296003	DS201 C32 AC30	2CSR255040R1324		0.275	5
		40	2	296102	DS201 C40 AC30	2CSR255040R1404		0.275	5
	100	6	2	296201	DS201 C6 AC100	2CSR255040R2064		0.275	5
		10	2	296409	DS201 C10 AC100	2CSR255040R2104		0.275	5
		13	2	370802	DS201 C13 AC100	2CSR255040R2134		0.275	5
		16	2	370901	DS201 C16 AC100	2CSR255040R2164		0.275	5
		20	2	371601	DS201 C20 AC100	2CSR255040R2204		0.275	5
		25	2	371700	DS201 C25 AC100	2CSR255040R2254		0.275	5
		32	2	371809	DS201 C32 AC100	2CSR255040R2324		0.275	5
		40	2	498100	DS201 C40 AC100	2CSR255040R2404		0.275	5

# Ordering Information

## DS201 - A type

2



DS201 B - A

**Function:** protection of end user single-phase circuits against overload and short-circuit currents; protection against the effects of sinusoidal alternating and direct pulsating earth fault currents; protection against indirect contact and additional protection against direct contact ( $I_{\Delta n}=30$  mA).

**Standard:** IEC/ EN 61009

$I_{cn} = 6000$  A

### B characteristic

N. of poles	Rated residual current	Rated current	N° module	Bbn 8012542	Order details		Price	Weight 1 piece Kg	Pack unit	
	$I_{\Delta n}$ mA	$I_n$ A	[17,5 mm]	EAN	Type code	Order code				
1+N	10	10	2	995708	DS201 B10 A10	2CSR255140R0105		0.275	5	
		13	2	995807	DS201 B13 A10	2CSR255140R0135		0.275	5	
		16	2	995906	DS201 B16 A10	2CSR255140R0165		0.275	5	
	30	30	6	2	638506	DS201 B6 A30	2CSR255140R1065		0.275	5
			10	2	647805	DS201 B10 A30	2CSR255140R1105		0.275	5
			13	2	655503	DS201 B13 A30	2CSR255140R1135		0.275	5
			16	2	655602	DS201 B16 A30	2CSR255140R1165		0.275	5
			20	2	655701	DS201 B20 A30	2CSR255140R1205		0.275	5
			25	2	766902	DS201 B25 A30	2CSR255140R1255		0.275	5
32			2	814504	DS201 B32 A30	2CSR255140R1325		0.275	5	
100	100	40	2	910602	DS201 B40 A30	2CSR255140R1405		0.275	5	
		6	2	990307	DS201 B6 A100	2CSR255140R2065		0.275	5	
		10	2	990406	DS201 B10 A100	2CSR255140R2105		0.275	5	
		13	2	990505	DS201 B13 A100	2CSR255140R2135		0.275	5	
		16	2	990604	DS201 B16 A100	2CSR255140R2165		0.275	5	
		20	2	990703	DS201 B20 A100	2CSR255140R2205		0.275	5	
		25	2	990802	DS201 B25 A100	2CSR255140R2255		0.275	5	
		32	2	990901	DS201 B32 A100	2CSR255140R2325		0.275	5	
300	300	40	2	991007	DS201 B40 A100	2CSR255140R2405		0.275	5	
		6	2	991908	DS201 B6 A300	2CSR255140R3065		0.275	5	
		10	2	992004	DS201 B10 A300	2CSR255140R3105		0.275	5	
		13	2	992103	DS201 B13 A300	2CSR255140R3135		0.275	5	
		16	2	992202	DS201 B16 A300	2CSR255140R3165		0.275	5	
		20	2	992301	DS201 B20 A300	2CSR255140R3205		0.275	5	
		25	2	992400	DS201 B25 A300	2CSR255140R3255		0.275	5	
300	300	32	2	992509	DS201 B32 A300	2CSR255140R3325		0.275	5	
		40	2	992608	DS201 B40 A300	2CSR255140R3405		0.275	5	



# Ordering Information

## DS201 - A type



DS201 C - A

2CSC400030F0053

### C characteristic

N. of poles	Rated residual current		N° module [17,5 mm]	Bbn 8012542 EAN	Order details		Price	Weight 1 piece Kg	Pack unit
	IΔn mA	In A			Type code	Order code			
1+N	10	10	2	996002	DS201 C10 A10	2CSR255140R0104		0.275	5
		13	2	996101	DS201 C13 A10	2CSR255140R0134		0.275	5
		16	2	996200	DS201 C16 A10	2CSR255140R0164		0.275	5
	30	2	2	123958	DS201 C2 A30	2CSR255140R1024		0.275	5
		4	2	942306	DS201 C4 A30	2CSR255140R1044		0.275	5
		6	2	942405	DS201 C6 A30	2CSR255140R1064		0.275	5
		8	2	124054	DS201 C8 A30	2CSR255140R1084		0.275	5
		10	2	952503	DS201 C10 A30	2CSR255140R1104		0.275	5
		13	2	976004	DS201 C13 A30	2CSR255140R1134		0.275	5
		16	2	976103	DS201 C16 A30	2CSR255140R1164		0.275	5
		20	2	976202	DS201 C20 A30	2CSR255140R1204		0.275	5
		25	2	976301	DS201 C25 A30	2CSR255140R1254		0.275	5
		32	2	990109	DS201 C32 A30	2CSR255140R1324		0.275	5
		40	2	990208	DS201 C40 A30	2CSR255140R1404		0.275	5
			100	6	2	991106	DS201 C6 A100	2CSR255140R2064	
10	2			991205	DS201 C10 A100	2CSR255140R2104		0.275	5
13	2			991304	DS201 C13 A100	2CSR255140R2134		0.275	5
16	2			991403	DS201 C16 A100	2CSR255140R2164		0.275	5
20	2			991502	DS201 C20 A100	2CSR255140R2204		0.275	5
25	2			991601	DS201 C25 A100	2CSR255140R2254		0.275	5
32	2			991700	DS201 C32 A100	2CSR255140R2324		0.275	5
40	2			991809	DS201 C40 A100	2CSR255140R2404		0.275	5
	300	6	2	992707	DS201 C6 A300	2CSR255140R3064		0.275	5
		8	2	124351	DS201 C8 A300	2CSR255140R3084		0.275	5
		10	2	992806	DS201 C10 A300	2CSR255140R3104		0.275	5
		13	2	992905	DS201 C13 A300	2CSR255140R3134		0.275	5
		16	2	993001	DS201 C16 A300	2CSR255140R3164		0.275	5
		20	2	993100	DS201 C20 A300	2CSR255140R3204		0.275	5
		25	2	993209	DS201 C25 A300	2CSR255140R3254		0.275	5
		32	2	993308	DS201 C32 A300	2CSR255140R3324		0.275	5
		40	2	993407	DS201 C40 A300	2CSR255140R3404		0.275	5

# Ordering Information

## DS201 - APR type

2



2CSR255440R1064

DS201 C - APR

**Function:** protection of end user single-phase circuits against overload and short-circuit currents; protection against the effects of sinusoidal alternating and direct pulsating earth fault currents, providing an optimal trade-off between safety and continuity of service thanks to the resistance to unwanted tripping; protection against indirect contact and additional protection against direct ( $I_{\Delta n}=30$  mA) contact; protection and isolation of resistive and inductive loads.

**Standard:** IEC/ EN 61009

$I_{cn} = 6000$  A

### C characteristic

N. of poles	Rated residual current	Rated current	N° module	Bbn 8012542	Order details			Weight 1 piece	Pack unit
	$I_{\Delta n}$ mA	In A	[17,5 mm]	EAN	Type code	Order code	Price		
1+N	30	6	2	997306	DS201 C6 APR30	2CSR255440R1064		0.275	5
		10	2	997405	DS201 C10 APR30	2CSR255440R1104		0.275	5
		13	2	997504	DS201 C13 APR30	2CSR255440R1134		0.275	5
		16	2	997603	DS201 C16 APR30	2CSR255440R1164		0.275	5
		20	2	997702	DS201 C20 APR30	2CSR255440R1204		0.275	5
		25	2	997801	DS201 C25 APR30	2CSR255440R1254		0.275	5
		32	2	997900	DS201 C32 APR30	2CSR255440R1324		0.275	5
		40	2	998006	DS201 C40 APR30	2CSR255440R1404		0.275	5

# Ordering Information

## DS202C - A type



DS202 B - A



DS202 C - A

**Function:** protection of end user two-phase circuits against overload and short-circuit currents; protection against the effects of sinusoidal alternating and direct pulsating earth fault currents; protection against indirect contact and additional protection against direct contact ( $I_{\Delta n}=30$  mA).

**Standard:** IEC/ EN 61009

$I_{cn} = 6000$  A

2

### B characteristic

N. of poles	Rated residual current $I_{\Delta n}$ mA	Rated current $I_n$ A	N° module [17,5 mm]	Bbn 8012542 EAN	Order details		Price	Weight 1 piece Kg	Pack unit
					Type code	Order code			
2	30	6	2	132257	DS202C B6 A30	2CSR252140R1065		0.275	5
		10	2	132356	DS202C B10 A30	2CSR252140R1105		0.275	5
		13	2	132455	DS202C B13 A30	2CSR252140R1135		0.275	5
		16	2	132554	DS202C B16 A30	2CSR252140R1165		0.275	5
		20	2	132653	DS202C B20 A30	2CSR252140R1205		0.275	5
		25	2	132752	DS202C B25 A30	2CSR252140R1255		0.275	5
		32	2	132851	DS202C B32 A30	2CSR252140R1325		0.275	5

### C characteristic

2	30	6	2	122357	DS202C C6 A30	2CSR252140R1064		0.275	5
		10	2	122456	DS202C C10 A30	2CSR252140R1104		0.275	5
		13	2	122555	DS202C C13 A30	2CSR252140R1134		0.275	5
		16	2	122654	DS202C C16 A30	2CSR252140R1164		0.275	5
		20	2	122753	DS202C C20 A30	2CSR252140R1204		0.275	5
		25	2	122852	DS202C C25 A30	2CSR252140R1254		0.275	5
		32	2	122951	DS202C C32 A30	2CSR252140R1324		0.275	5

# Technical details

## DS201 and DS202C Series

### Tripping diagrams

#### B characteristic

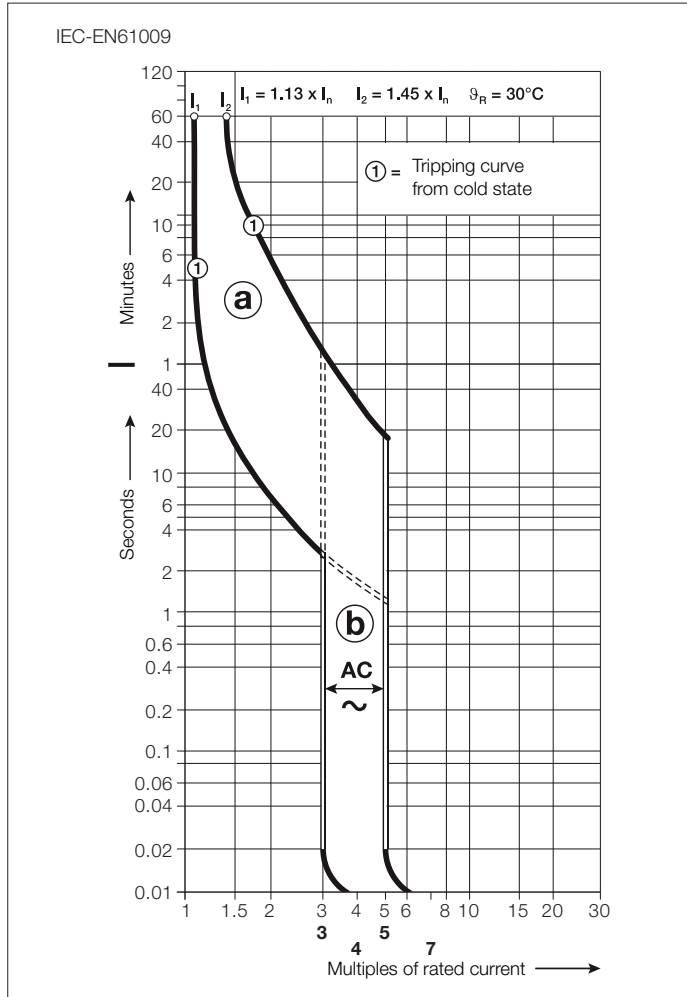

#### C characteristic

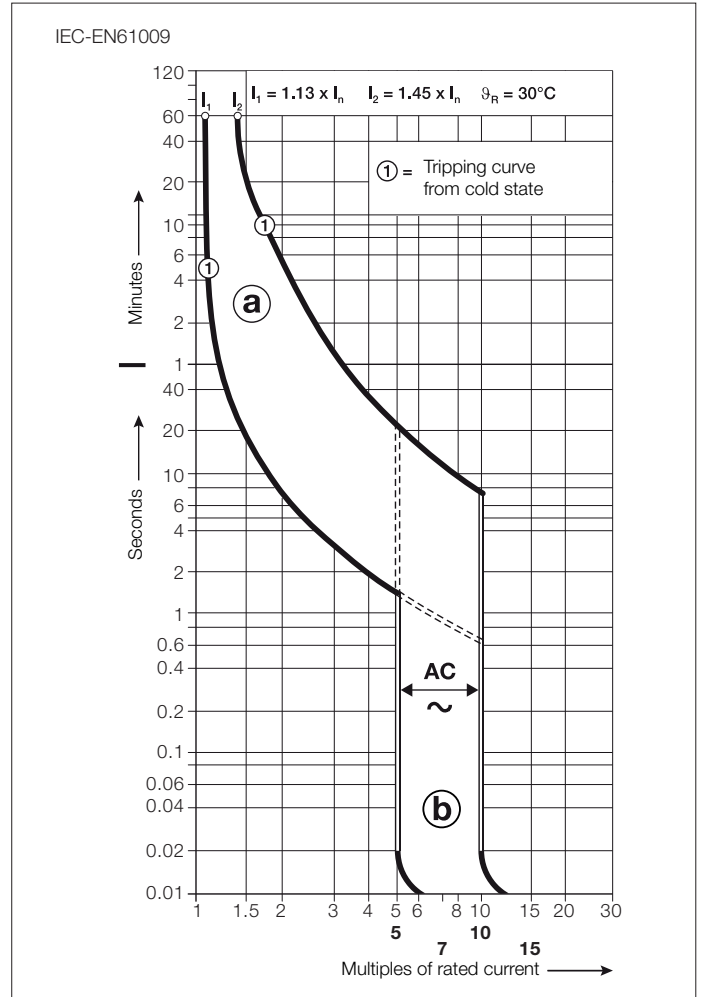

- Ⓐ thermal trip
- Ⓑ electromagnetic trip

## Limitation of specific let-through energy $I^2t$

The  $I^2t$  curves give the values of the specific let-through energy expressed in  $A^2s$  (A=amps; s=seconds) in relation to the perspective short-circuit current ( $I_{rms}$ ) in kA.

**DS201 L - DS201 - DS202C**  
 230 V let-through energy

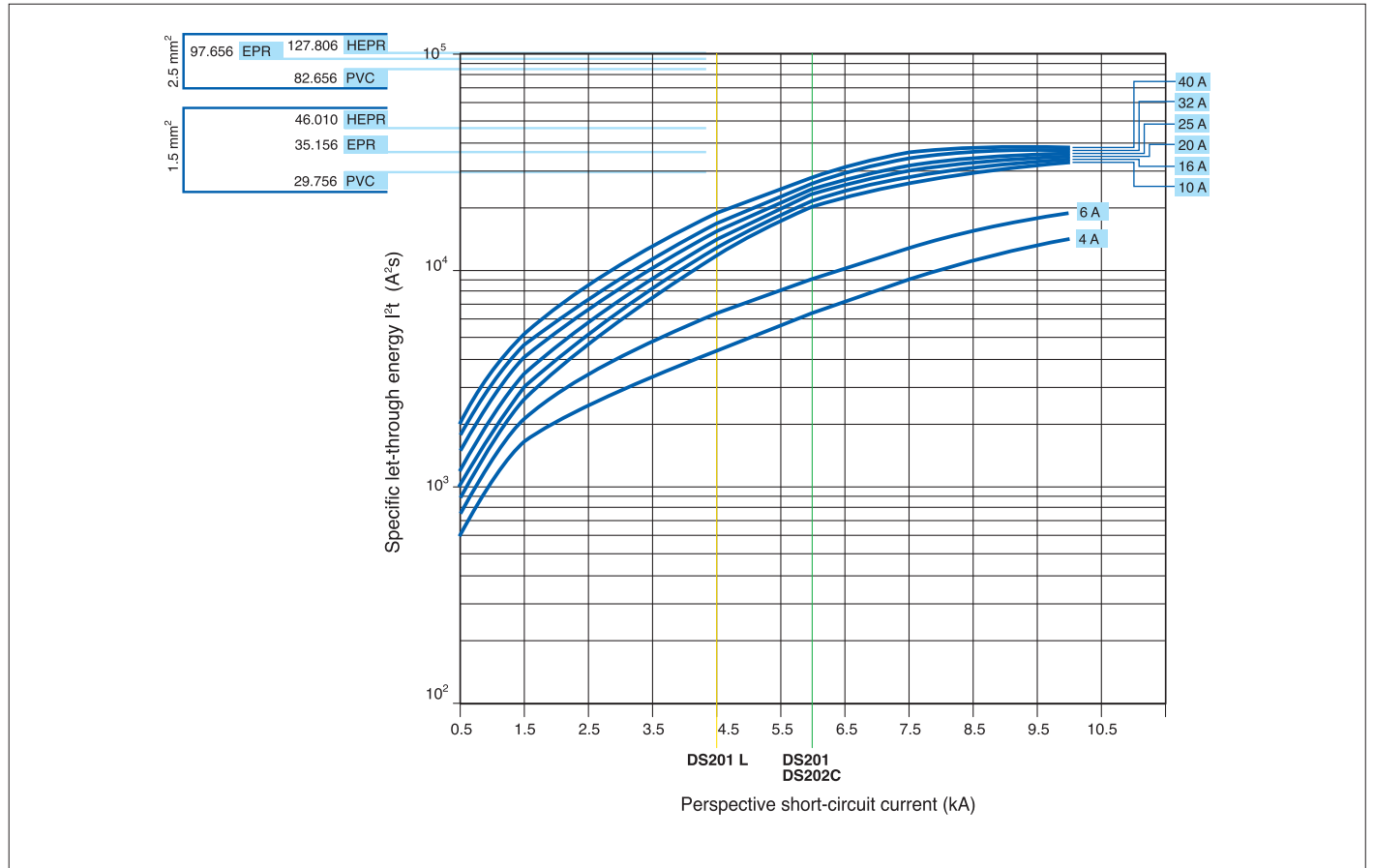

# Technical details

## DS201 and DS202C Series

### Peak current $I_p$

The  $I_p$  curves give the values of the peak current, expressed in kA, in relation to the perspective symmetrical short-circuit current (kA).

2

**DS201 L - DS201 - DS202C**  
230 V

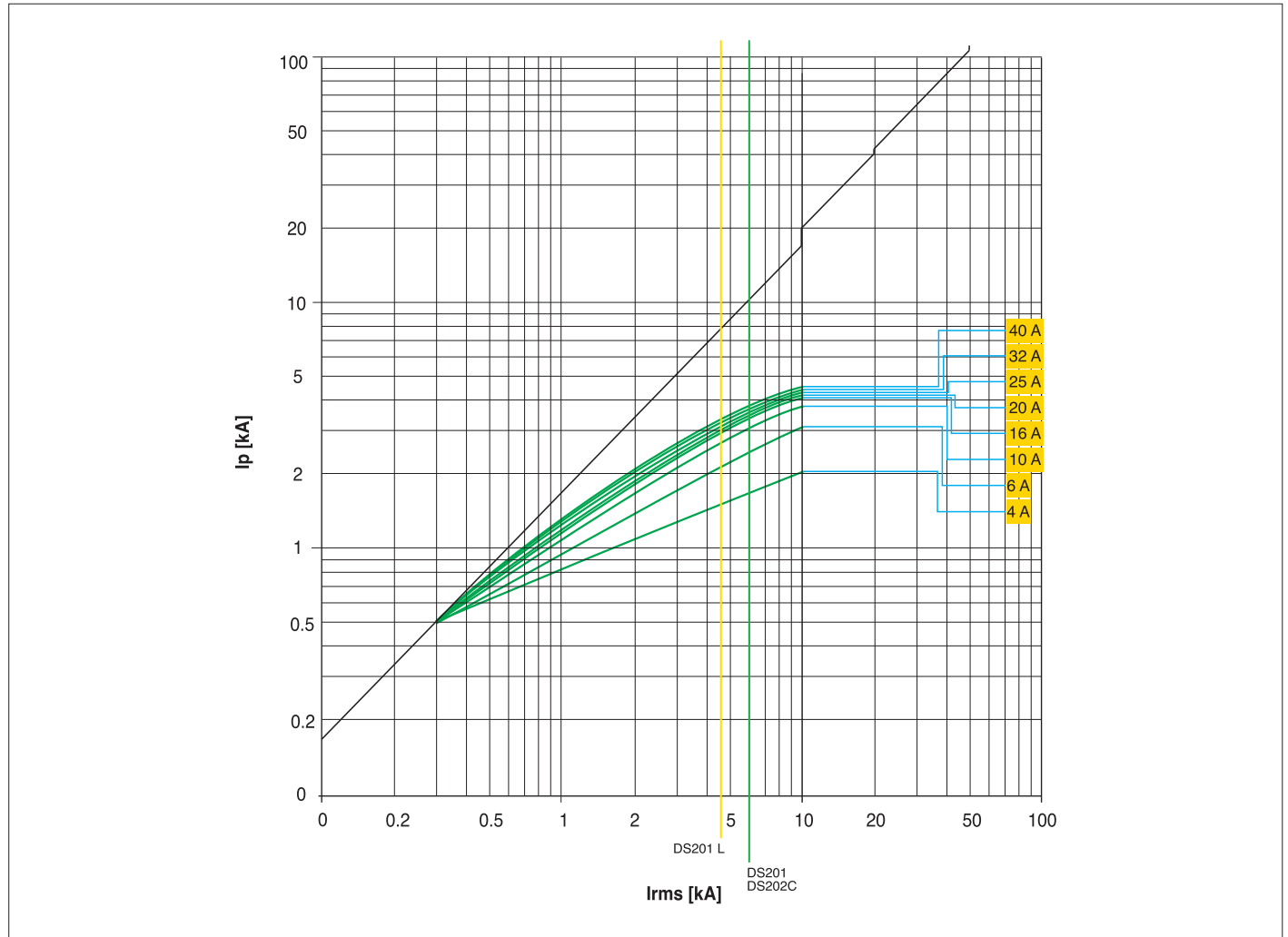



## Power loss and internal resistance

### DS201

Rated current In [A]	Power loss [W]	Internal resistance [mΩ]
2	1.6	411
4	2.5	155
6	4.4	123.4
8	1.5	23.1
10	2.3	23.1
13	2.2	13.3
16	3.4	13.3
20	4.4	11.1
25	3.9	6.2
32	5.9	5.8
40	8.6	5.4

### DS202C

Rated current In [A]	Power loss [W]	Internal resistance [mΩ]
6	8.1	224.8
10	4.1	40.6
13	3.5	21
16	5.4	21
20	6.6	16.6
25	5.5	8.8
32	8.2	8

# Overall dimensions

## FH202 - F202

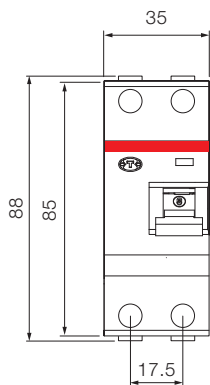
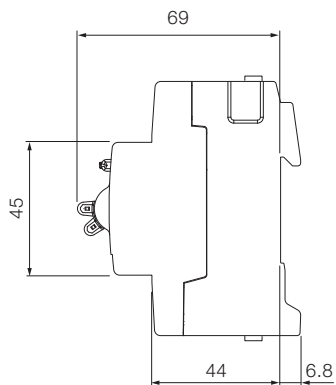

## FH204 - F204

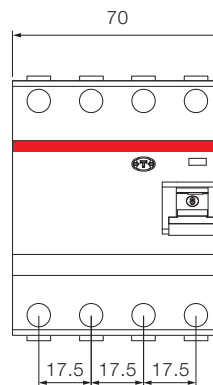

## DS201 - DS202C

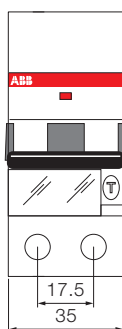
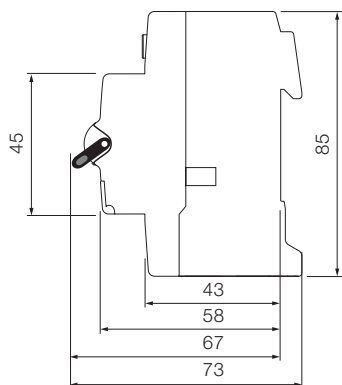

# Surge protective devices

## OVR

Plus of range	2/56
Technical features table	2/58
Ordering information	2/60
Overall dimensions	2/61

# OVR Plus and T2 range. The details make the difference A complete range for your surge protection

2

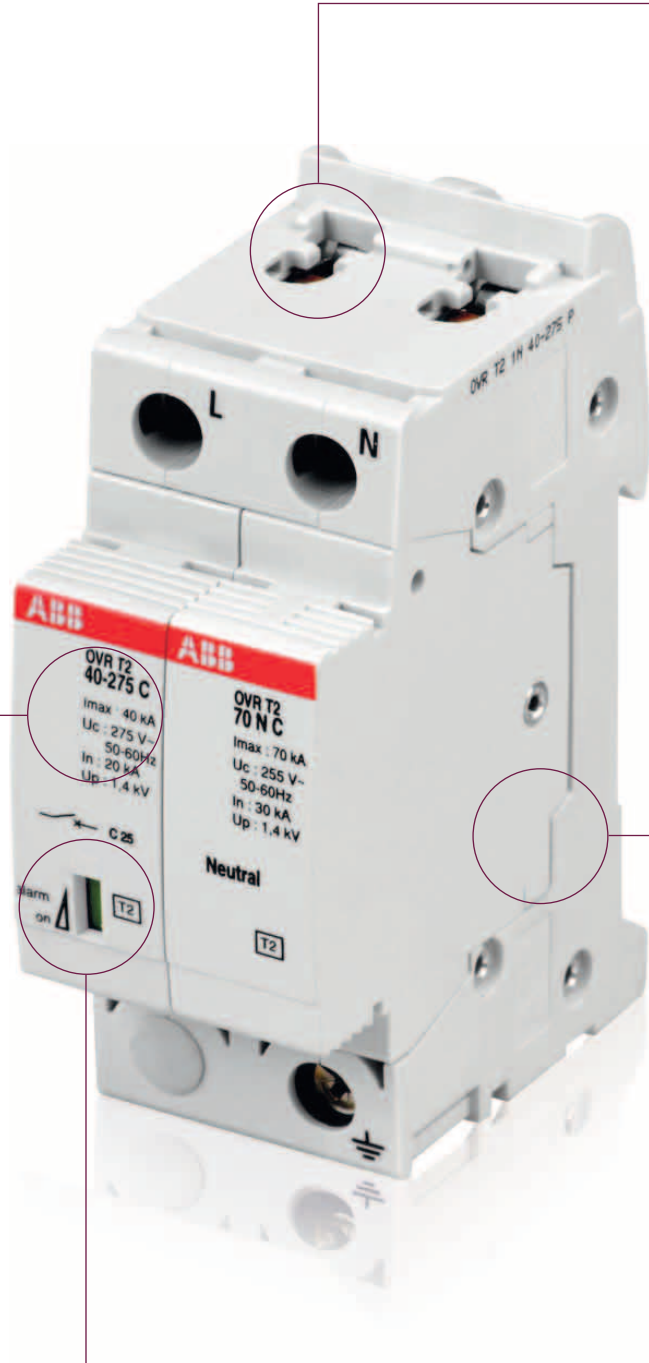

Standard pro *M* terminals design for a better coordination with the complete ABB System pro *M* compact® modular range.

Clear information on the front of the product indicating the technical characteristics of the OVR T2 range.

Pluggable cartridges.

Visualisation of the status of the SPD on the front of the product.



The bidirectional cylindrical terminal block of the OVR T2 and Plus range allows a complete coordination with the ABB range with considerable time savings in wiring operations. All the devices allow connection through busbars, both from above and from below.

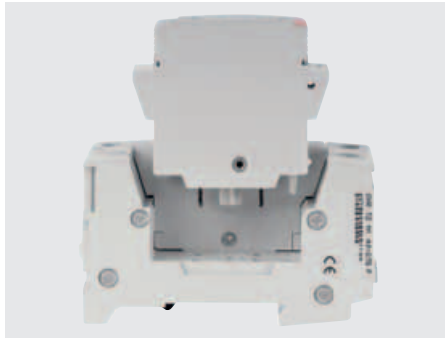

The pluggable feature of ABB surge arresters facilitates maintenance. Should one or more worn cartridges need to be replaced, the electrical circuit does not have to be isolated nor do the wires have to be removed.



The end-of-service-life indicator of the surge protective device signals the status of the device. A mechanical indicator turns from green to red when the SPD reaches the end of its service life.



The toggle of the miniature circuit breaker indicates the status of the OVR Plus range. If the toggle is on, the surge protection is active. If the toggle is off and can be switched on again, the device has protected your equipment. If the toggle is off and cannot be switched on. The device must be changed.



The configuration allows to use the OVR Plus range on TT and TNS network in Phase + Neutral and 3 Phases + Neutral with a high surge capacity up to 40kA Imax.

# Technical features table surge arresters OVR and OVR PLUS Series

2



2CSC400030F00089

		OVR T1+2 xx 7 s P
Technology		MOVs
<b>Electrical features</b>		
Standard		EN 61643-11, IEC 61643-1
Type / test class		T1-T2 / I-II
Poles		- / 1N / 3L / 4L
Types of networks		TNC-TNS-TT
Type of current		V
Nominal voltage Un (L-N/L-L)		V
Max. cont. operating voltage Uc		V
Impulse current Iimp (10/350) per pole		kA
Maximum discharge current Imax (8/20) per pole		kA
Nominal discharge current In (8/20) per pole		kA
Voltage protection level Up (L-N / N-PE / L-PE)		kV
Residual voltage Ures at 3kA (L-N / N-PE)		kV
Follow current interrupting rating Ifi		kA
TOV (Temporary overvoltage) withstand Ut (L-N: 5s./N-PE: 200ms)		V
Continuous operating current Ic		mA
Short-circuit withstand capability		kA
Disconnecter	gG -gL fuse	A
	curve C circuit breaker	A
Pluggable cartridge		Yes
Integrated thermal disconnecter		Yes
State indicator		Yes
TS auxiliary contact		No
<b>Mechanical features</b>		
Stocking temperature		°C
Operating temperature		°C
Degree of protection		IP 20
Fire resistance according to UL 94		V0
<b>Installation</b>		
Wire range (L, N)		
solid wire	mm <sup>2</sup>	2.5 ... 25
stranded wire	mm <sup>2</sup>	2.5 ... 16
Stripping length (L, N)		mm
Tightening torque (L, N)		Nm
<b>Technical features of the integrated auxiliary contact (TS)</b>		
<b>Electrical features</b>		
Contact complement		-
Min. load		-
Max. load		-
<b>Installation</b>		
Connection cross-section		mm <sup>2</sup>





2CSC400030F0070



2CSC400030F0071



2CSC400030F0072



2CSC400030F0073

OVR T2 xx xx 275 P			OVR T2 xx xx 440 P			OVR Plus N1 40		OVR Plus N3 XX	
MOVs			MOVs			MOVs			
EN 61643-11, IEC 61643-1			EN 61643-11, IEC 61643-1			EN 61643-11, IEC 61643-1			
T2 / II			T2 / II			T2 / II			
-	3L / 4L	1N / 3N	-	3L / 4L	1N / 3N	N1	N3		
TNC-TNS		TNS-TT	IT-TNC-TNS		TNS-TT	TT-TNS			
AC			AC			AC			
230/400			400/400			230/400			
275			440			320			
-			-			-		-	
15 / 40			15 / 40			40		15 / 40	
5 / 20			5 / 20			20		5 / 20	
- / - / 1.0	- / - / 1.4	1.4 / 1.4 / 1.5	- / - / 1.0	- / - / 1.9	1.9 / 1.4 / 1.9	1.6 / - / 1.8		1.3 / 1.3 / 1.3 2.0 / 1.5 / 2.0	
- / - / 0.9		0.9 / 0.9 / 0.9	- / - / 1.3		1.3 / 1.2 / 1.3	1.0 / - / 1.0		1.1 / 1.1 / 1.1	
na			na			na		na	
334 / -		334 / 1200	440 / -		440 / 1200	334 / 1200			
<1			<1			<1			
50			50			15		10 / 15	
≤ 50			≤ 50			Integrated MCB disconnector			
≤ 50			≤ 50			Integrated MCB disconnector			
Yes			Yes			No			
Yes			Yes			Yes			
Yes			Yes			Yes (MCB)			
Option			Option			S2C-H6R			
-40 to +80			-40 to +80			-40 to +80			
-40 to +70			-40 to +70			-40 to +70			
IP 20			IP 20			IP 20			
V0			V0			V0			
2.5 ... 25			2.5 ... 25			2.5 ... 25			
2.5 ... 16			2.5 ... 16			2.5 ... 16			
12,5			12,5			11			
2.8			2.8			2.8			
1 NO - 1 NC			1 NO - 1 NC			-			
12 VDC - 10mA			12 VDC - 10mA			-			
250 VAC - 1A			250 VAC - 1A			-			
1.5			1.5			-			

# Ordering Information

## OVR and OVR PLUS Series - Type 1+2 and Type 2

2

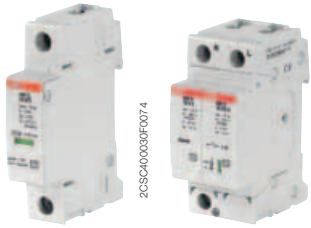

2CSC400030F0074

2CSC400030F0070

OVR T2 15

OVR T2 N1 15



2CSC400030F0072

OVR PLUS N1 40



2CSC400030F0071

OVR T2 3L 40



2CSC400030F0076

OVR T2 3N 15



2CSC400030F0073

OVR PLUS N3 40



2CSC400030F0077

OVR T2 4L 40

Surge Protective Devices, Type 2, to protect sensible equipment and the installation from indirect surges.

N. of poles	Nom. voltage Un V	Impulse current limp	Max. disch. current I <sub>max</sub> kA	N° module 17,5 mm	Bbn 3660308 EAN	Order details		Price	Weight 1 piece Kg	Pack unit
						Type code	Order code			
1	230	7	70	1	513403	OVR T1+2 7 275 s P	2CTB815101R3900		0.120	1
	230	-	15	1	514882	OVR T2 15 275	2CTB804200R0100		0.120	1
	230	-	15	1	512840	OVR T2 15 275 P	2CTB803851R2400		0.120	1
	230	-	40	1	514103	OVR T2 40 275	2CTB804201R0100		0.120	1
	230	-	40	1	512833	OVR T2 40 275 P	2CTB803851R2300		0.120	1
	400	-	15	1	512772	OVR T2 15 440 P	2CTB803851R1100		0.120	1
	400	-	40	1	512789	OVR T2 40 440 P	2CTB803851R1200		0.120	1
1+N	230	-	15	2	513106	OVR T2 1N 15 275 P	2CTB803952R1200		0.220	1
	230	-	40	2	513250	OVR T2 1N 40 275 P	2CTB803952R1100		0.220	1
	230	-	40	2	517005	OVR PLUS N1 40	2CTB803701R0400		0.260	1
3	230	7	70	1	513410	OVR T1+2 3L 7 275 s P	2CTB815101R0400		0.400	1
	230	-	15	2	512987	OVR T2 3L 15 275 P	2CTB803853R3400		0.350	1
	230	-	40	2	513366	OVR T2 3L 40 275 P	2CTB803853R2400		0.350	1
	400	-	40	2	516879	OVR T2 3L 40 440 P	2CTB803953R2600		0.350	1
3+N	230	7	70	1	514141	OVR T1+2 3N 7 275 s P	2CTB815502R1000		0.500	1
	230	-	15	2	513151	OVR T2 3N 15 275 P	2CTB803953R1200		0.450	1
	230	-	40	2	513267	OVR T2 3N 40 275 P	2CTB803953R1100		0.450	1
	230	-	15	2	517081	OVR PLUS N3 15	2CTB803701R0400		0.790	1
	230	-	40	2	517074	OVR PLUS N3 40	2CTB803701R0300		0.790	1
4	230	7	70	1	513427	OVR T1+2 4L 7 275 s P	2CTB815101R4100		0.500	1
	230	-	15	2	513038	OVR T2 4L 15 275 P	2CTB803853R6000		0.450	1
	230	-	40	2	513274	OVR T2 4L 40 275 P	2CTB803853R5600		0.450	1
	400	-	40	2	516916	OVR T2 4L 40 440 P	2CTB803853R5100		0.450	1

# Overall dimensions

## OVR T2

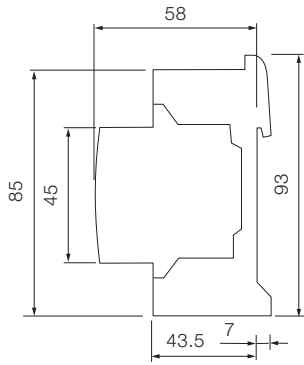

## OVR T2 with TS

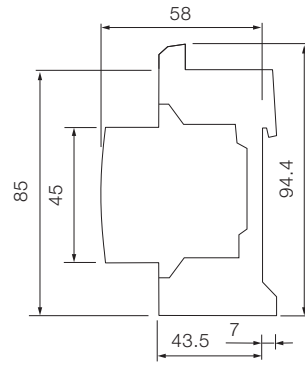

### 1-pole

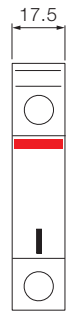

OVR T1+2 7  
OVR T2 15  
OVR T2 40

### 2-poles (1P+N)

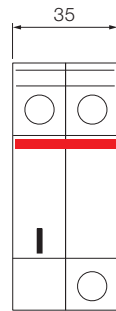

OVR T2 1N 15  
OVR T2 1N 40

### 3-poles

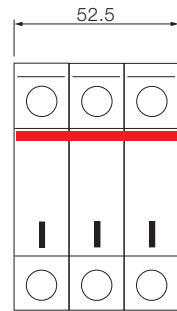

OVR T1+2 3L 7  
OVR T2 3L 15  
OVR T2 3L 40

### 4 poles (4P+0)

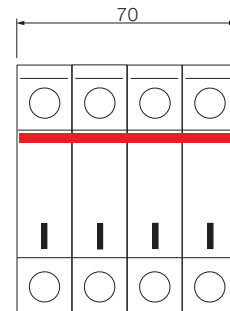

OVR T1+2 4L 7  
OVR T2 4L 15  
OVR T2 4L 40

### 3 poles (3P+N)

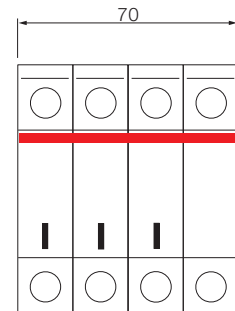

OVR T1+2 3N 7  
OVR T2 3N 15  
OVR T2 3N 40

## OVR Plus

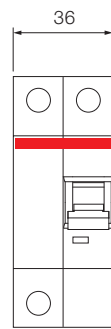
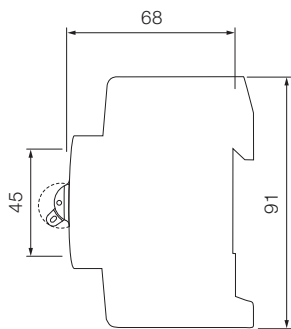

OVR Plus N1 40

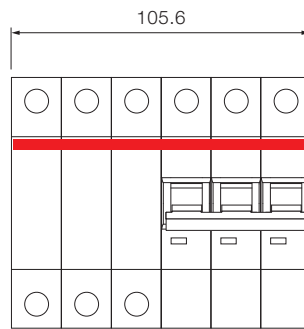

OVR Plus N3 15  
OVR Plus N3 40



# Other protection devices

## Ordering information

E 90	2/64
TM	2/65
TS	2/66
TS C	2/67
TSM and TSR	2/68

Technical details	2/69
Overall dimensions	2/74

# Ordering Information

## E 90 fuseholders for 10.3x38 mm fuses

2



2CSC400030F0057

E 91/32



2CSC400030F0088

E 91HN/32



2CSC400030F0089

E 93HN/32

E 90h fuseholders are suitable for protection against overloads and short circuits. Available in a single module 1P+N version and in a three-module 3P+N version, they are designed for use with gG and aM cylindrical fuse links. The body is made from self-extinguishing material resistant to high temperatures, while the contact clips are in silver-plated copper.

E 90h fuseholders can be sealed or padlocked to assure operator safety during maintenance. Versions with blown fuse indicator allow to check whether the fuse is still working correctly or not.

N. of poles	Rated current	N° module	Bbn	Order details			Weight 1 piece	Pack unit
	In A		8012542	Type code	Order code	Price		
		[17,5 mm]	EAN					
1	32	1	009238	E 91/32	2CSM200923R1801		0.061	6
1+N	32	1	009139	E 91HN/32	2CSM200913R1801		0.070	6
3+N	32	3	047438	E 93HN/32	2CSM204743R1801		0.192	2



# Ordering Information

## TM fail safe bell transformers



TM15/12

These transformers, with safety extremely-low voltage secondary (SELV), are suitable for loads that require a discontinuous supply, and in particular doorbells and chimes.

Fail safe operation and excellent safety are assured thanks to the perfect isolation and separation between the primary and secondary circuits.

Maxim. rated power (disc.)	Second. voltage rating	N° module	Bbn 8012542	Order details		Weight 1 piece	Pack unit
VA	V AC	[17,5 mm]	EAN	Type code	Order code	Price Kg	
10	4-8-12	2	367109	TM10/12	2CSM101021R0801	0.300	6
10	12-24	2	367208	TM10/24	2CSM101041R0801	0.300	6
15	4-8-12	2	367307	TM15/12	2CSM151021R0801	0.300	6
15	12-24	2	367406	TM15/24	2CSM151041R0801	0.300	6
30	4-8-12	3	367505	TM30/12	2CSM301021R0801	0.450	4
30	12-24	3	367604	TM30/24	2CSM301041R0801	0.450	4

# Ordering Information

## TS non-inherently short-circuit proof bell transformers

2



2CSC400030F0061

TS8/8



2CSC400030F0062

TS8/12 SW



2CSC400030F0063

TS24/8-12-24

These transformers, with safety extremely-low voltage secondary (SELV), are suitable for driving loads that call for a discontinuous supply, and in particular doorbells and chimes. In addition to perfect isolation and separation between the primary and secondary circuits, the TS transformers have a thermal protection device integrated into the secondary that makes them resistant to short circuit currents (non-inherently short-circuit proof).

In addition, the TS8/SW series is equipped with a switch for controlling loads connected to the secondary.

Maxim. rated power (disc.)	Second. voltage rating	Switch 0-1	N° module	Bbn 8012542	Order details		Weight 1 piece	Pack unit	
VA	V AC		[17,5 mm]	EAN	Type code	Order code	Price	Kg	
8	8		2	368007	TS8/8	2CSM081301R0811		0.355	6
8	12		2	368106	TS8/12	2CSM081401R0811		0.355	6
8	24		2	368205	TS8/24	2CSM081501R0811		0.355	6
8	8	■	2	368304	TS8/8SW	2CSM081302R0811		0.277	6
8	12	■	2	368403	TS8/12SW	2CSM081402R0811		0.277	6
8	4-6-8	■	2	368601	TS8/4-6-8SW	2CSM081012R0811		0.280	6
8	4-8-12	■	2	368700	TS8/4-8-12SW	2CSM081022R0811		0.280	6
16	8		2	368809	TS16/8	2CSM161301R0811		0.355	6
16	12		2	368908	TS16/12	2CSM161401R0811		0.355	6
16	24		2	369004	TS16/24	2CSM161501R0811		0.330	6
16	4-6-8		2	369103	TS16/4-6-8	2CSM161011R0811		0.330	6
16	4-8-12		2	369202	TS16/4-8-12	2CSM161021R0811		0.330	6
24	4-8-12		3	369301	TS24/4-8-12	2CSM241021R0811		0.465	4
24	8-12-24		3	369400	TS24/8-12-24	2CSM241031R0811		0.465	4

# Ordering Information

## TS-C safety isolating transformers for general use



2CSC400030F0064

TS25/12-24 C



2CSC400030F0065

TS63/12-24 C

These transformers are non-inherently short-circuit proof. In fact they are equipped with a thermal protective device which automatically restores the power when the transformer is sufficiently cooled down. So even during an overload or a short-circuit they maintain their temperature below the specified limits and they continue functioning after the fault's removal. They are ideal for supplying permanent power to meters, auxiliary electronic devices (e.g. measurement, video-entry phone systems, BUS communication) and circuits with safety extremely-low voltage (SELV) for bathrooms and showers, lighting, fountains, electro-medical devices and suchlike.

One important feature of these new devices is that they take up very little space in the 4-module size for the 25 and 40 VA versions and the 5-module size for the 63 VA version.

Rated power (cont.)	Second. rated voltage	N° module	Bbn 8012542	Order details		Price	Weight 1 piece	Pack unit
				Type code	Order code			
VA	V	[17,5 mm]	EAN					
25	12-24	4	928508	TS25/12-24 C	2CSM251043R0811		0.920	1
40	12-24	4	928607	TS40/12-24 C	2CSM401043R0811		1.000	1
63	12-24	5	928706	TS63/12-24 C	2CSM631043R0811		1.150	1

# Ordering Information

## Bells and buzzers

2



TSM



TSR

The range of bells and buzzers includes modular versions for discontinuous use SM1, RM1, TSM and TSR, suitable for acoustic signalling in residential and commercial sectors, and versions for continuous use SM2 and RM2, which are able to operate continuously for up to 12 hours while maintaining the quality and level of the sound. RM2 and SM2 are dedicated to specific applications such as acoustic signalling in the industry, alarms notification, supervision and intensive use (schools, factories etc...). TSM and TSR versions also include a transformer: the input is 230V a.c. and the bell is supplied in 12 or 24 V.

Rated voltage	Use	N° module	Bbn 8012542	Order details			Weight 1 piece	Pack unit
V AC		[17,5 mm]	EAN	Type code	Order code	Price	Kg	
<b>TSM modular electronic bell (two-tones) + transformer included</b>								
230	Discontinuous	2	007005	TSM	2CSM100000R0841		0.300	6
<b>TSR bell + buzzer + transformer included</b>								
230	Discontinuous	2	369608	TSR	2CSM100000R0831		0.300	1

# Technical details

## E 90

		E 90/32	E 90hN/32
Fuse	mm	10 x 38	
Current type		AC / DC	
Rated frequency	Hz	= / 50-60	
Rated current	A	32	
Max power dissipation	W	3	
Tightening torque	Nm	PZ2 2-2.5	PZ2 0.8-1.2
Terminal cross section	mm <sup>2</sup>	25	16
Protection degree		IP20	
Can be padlocked (open)		■	
Can be sealed (closed)		■	
<b>IEC 60947-3</b>			
Rated operating voltage	V	400	-
Utilization category		AC-22B	-
Markings		IMQ, NF	-
<b>Alternate current characteristics according to IEC 60947 - 3</b>			
Rated operating voltage	V	690	-
Utilization category		AC-22B	-
<b>Direct current characteristics according to IEC 60947 - 3</b>			
Rated operating voltage	V	690	-
Utilization category		DC-20B*	-
<b>IEC 60269-1</b>			
Rated AC voltage	V	690	
Rated DC voltage	V	690	
<b>IEC 60269-2</b>			
Fuse system		F	
Rated AC voltage	V	690	
Rated DC voltage	V	440	
Breaking capacity	kA	200 (AC) – 100 (DC)	
<b>IEC 60269-3</b>			
Fuse system		B	
Rated AC voltage	V	400	
Markings		-	IMQ
<b>IEC 60269-4</b>			
Fuse system		F	
Rated AC voltage	V	690	
Rated DC voltage	V	690	
<b>UL 4248</b>			
Mark		-	cURus

### Electrical symbols

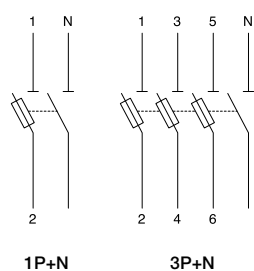

# Technical details

## TM

2

		<b>TM</b>
Rated primary voltage Un	V	230 a.c.
Rated secondary voltage Un	V	4, 8, 12, 24
Rated frequency	Hz	50/60
Rated power (discontinuous)	VA	10, 15, 30, 40
Power loss	W	1...4
Modules	No.	2 (TM10, TM15), 3 (TM30, TM40)
Cable section (Ø min/max)	mm <sup>2</sup>	1.5 / 10
Tightening torque	Nm	1
Protection degree		IP 20
Reference standards		IEC/EN 61558-2-8
Approvals		GOST, IMQ (TM10, TM15, TM30)

### Wiring diagrams and marking information

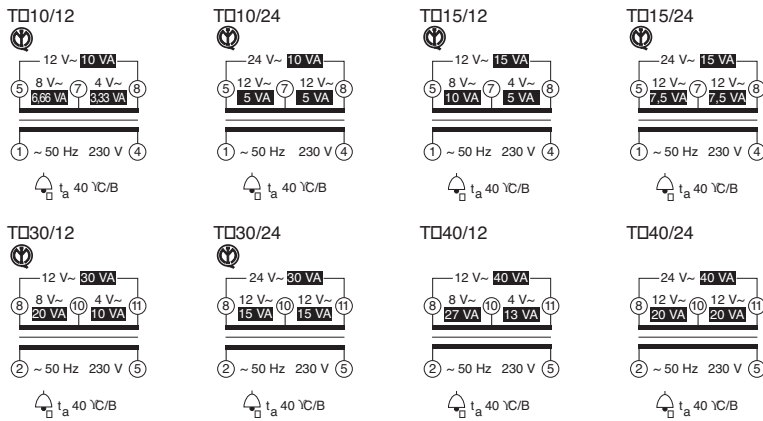

# Technical details

## TS

		<b>TS</b>
Rated primary voltage Un	V	230 a.c.
Rated secondary voltage Un	V	4, 8, 12, 24
Rated frequency	Hz	50/60
Rated power (discontinuous)	VA	10, 15, 30, 40
Power loss	W	1...4
Modules	No.	2 (TM10, TM15), 3 (TM30, TM40)
Cable section (Ø min/max)	mm <sup>2</sup>	1.5 / 10
Tightening torque	Nm	1
Protection degree		IP 20
Reference standards		IEC/EN 61558-2-8
Approvals		VDE, GOST

2

### Wiring diagrams and marking information

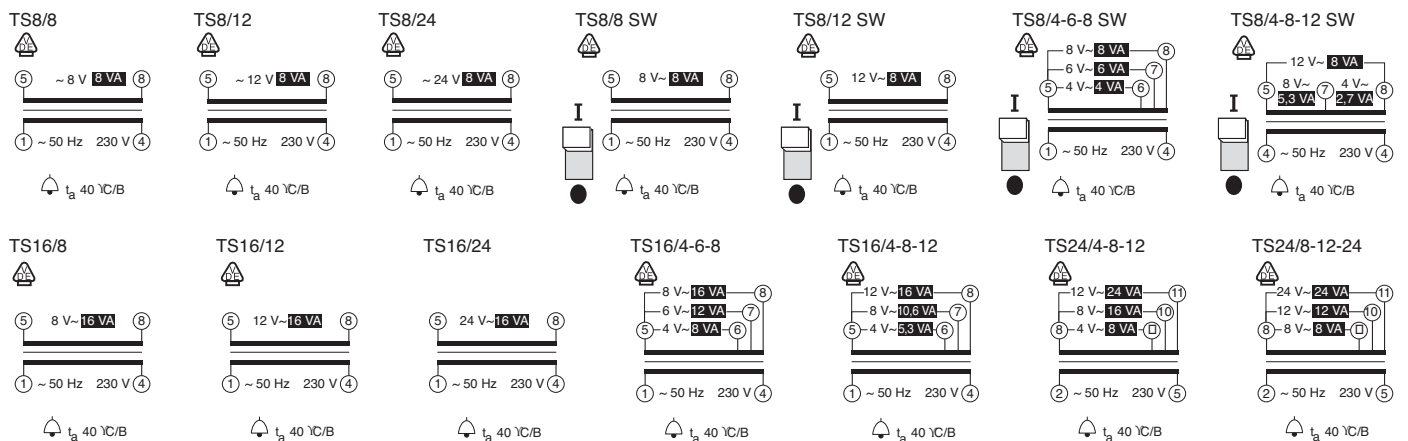



# Technical details

## TS C

2

		<b>TS 25 C</b>	<b>TS 40 C</b>	<b>TS 63 C</b>
Primary rated voltage Un	V	230 AC	230 AC	230 AC
Secondary rated voltage Un	V	12 - 24 V AC	12 - 24 V AC	12 - 24 V AC
Rated frequency	Hz	50/60	50/60	50/60
Rated power (continuous use)	VA	25	40	63
Power loss	W	5	10	16,7
Modules	No.	4	4	5
Standards		IEC/EN 61558-2-6		
Approvals		IMQ, VDE, GOST		

### Wiring diagrams and marking information

TS25/12-24 C

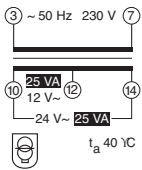

TS40/12-24 C

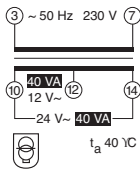

TS63/12-24 C

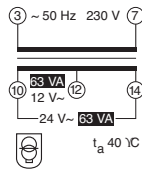

# Technical details

## TSM, TSR

		<b>TSM, TSR</b>	
Rated Voltage Un	V AC	230	
Rated frequency	Hz	50	
Power consumption	VA	5,5	
Sound level at 1 meter	SM:	dB	80
	RM:	dB	70
Max permanent working time		TSM: 1 min TSR: 5 min	
Max cable cross-section	mm <sup>2</sup>	10	
Mounting position		vertical only	
Protection degree		IP20-IP40, switchboard mounting	
Modules	No.	2	

2

### Wiring diagrams and marking information

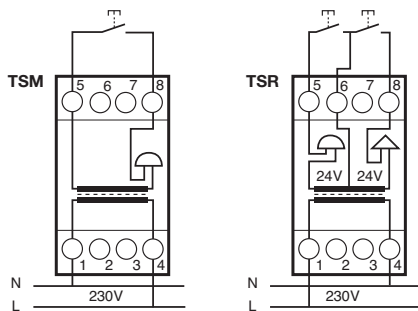

# Overall dimensions

## E 90 fuse disconnectors and E 90h fuse holders

2

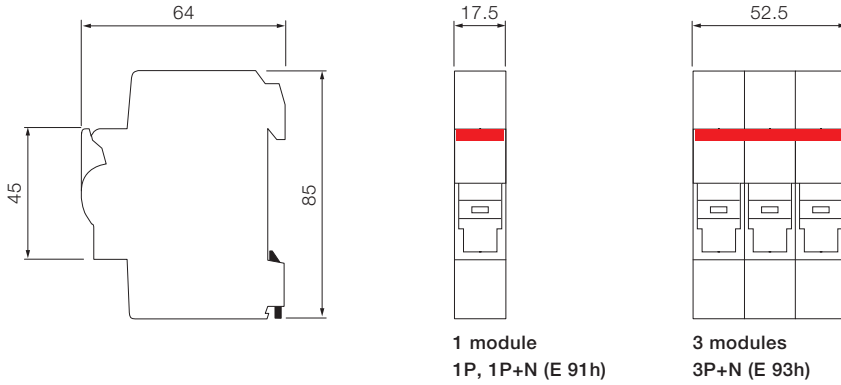

## TM/TS bell transformers

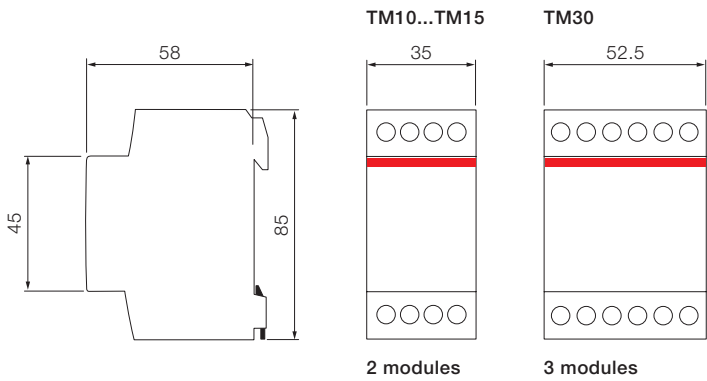

## TS-C safety isolating transformers for general use

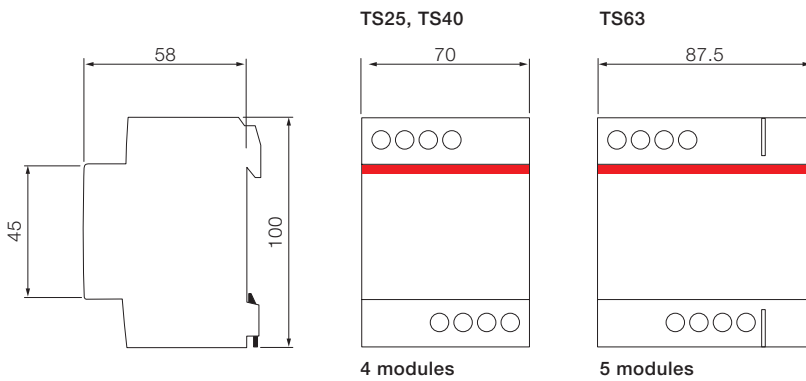

## Bells and buzzers

TSR

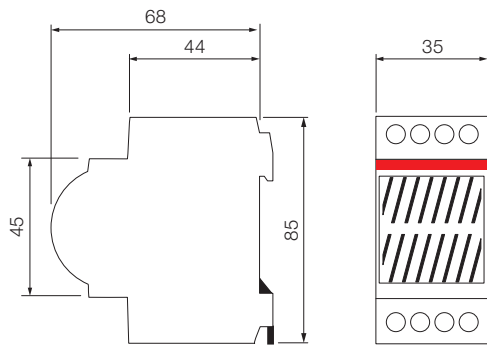

TSM

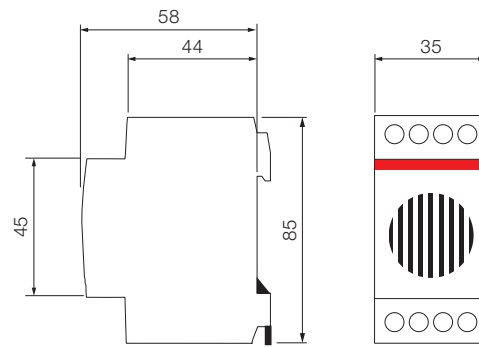



# Busbars and end caps

# Ordering Information

2

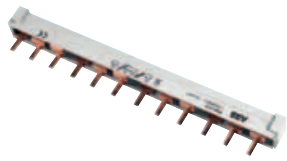

PSH3/12

2CSC400030F0068

Phase sequence	End cap	Bbn 4016779	Order details			Pack unit
		EAN	Type code	Order code	Price	
<b>Busbar</b>						
L1-L1-...	PSH-END 1.1	-	PSH 1/6	2CDL110001R1006		50
L1-L1-...	PSH-END 1.1	-	PSH 1/7	2CDL110001R1007		50
L1-L1-...	PSH-END 1.1	651868	PSH 1/12	2CDL110001R1012		50
L1-L1-...	PSH-END 1.1	651875	PSH 1/60	2CDL110001R1060		20
L1-L2-L1-...	incl.	651882	PSH 2/12	2CDL120001R1012		50
L1-L2-L1-...	PSH-END	651899	PSH 2/58	2CDL120001R1058		10
L1-L2-L3-L1-...	incl.	651905	PSH 3/12	2CDL130001R1012		50
L1-L2-L3-L1-...	PSH-END	651912	PSH 3/60	2CDL130001R1060		10
L1-L2-L3-N-L1-...	incl.	651929	PSH 4/12	2CDL140001R1012		30
L1-L2-L3-N-L1-...	PSH-END 1	651936	PSH 4/60	2CDL140001R1060		10
L1-N-L2-N-L3-N-...	PSH-END 1	-	PSH 4/58N	2CDL140001R1058		10
<b>End cap</b>						
-	-	653169	PSH-END 1.1	2CDL100011R0011		50
-	-	514729	PSH-END	2CDL100001R0001		50
-	-	653183	PSH-END 1	2CDL100001R0002		50



# Command and alerts

Introduction	3/2
--------------	-----

## Ordering information

E 210 switches	3/4
E 210 pushbuttons with and without LEDs	3/6
E 210 indicator Lights with LEDs	3/7
E 200 switches	3/8
E 250 latching relays	3/10
E 260 electronic latching relays	3/12
FLR flush mounting latching relays	3/14
E 259 installation relays	3/15
SM/RM bells and buzzers	3/16
ESB installation contactors	3/17
EN series contactors	3/19
EH04... auxiliary contact block	3/21

Overall dimensions	3/22
--------------------	------

## Simplicity of control makes life easier

### Command and alert devices

Using modular DIN-rail mounted devices (MDRC) such as on-off switches, pushbuttons, indicator lights, disconnectors, relays, contactors, bells and buzzers makes it possible to switch and control electric loads from a central location. Thanks to signalling, operating states can be recognized easily and user always has the complete control of the situation.

3

The range is completed by a complete range of accessories and auxiliary elements such as auxiliary contact blocks, sealing cover and distance pieces



ABB offers a complete range of modular DIN-rail mounted devices (MDRC) that makes it possible to switch and control electric loads from a central location. Thanks to the new narrow width of only 9 mm (0.5 modular width) place is saved in the distribution board. Integration of modular installation devices in the distribution boards affords the additional advantage of intelligible signalling of electric loads operating states. Easy operation or interpretation of devices is ensured by the clearly recognizable switching position (toggle lever) and/or a status display by means of an LED light. Depending on the system requirements, further signalling or control functionality for reliable operation can be used in the subdistribution board in the form of pushbuttons or indicator lights. Switch are available for different functions: on-off, change over, group control. Commands can be coupled with electro-magnetic and electronic latching relays which allow contact switching for each impulse sent using single or parallel pushbutton. Ideal for load controlling from different positions, they are

available in various versions according to pick-up voltage, contact position, installation options. They also allow manual operation on the product and contact position indicator (visual on the product). Also important in command portfolio of product is the range of bells and buzzers, which includes modular versions for discontinuous use SM1 and RM1, suitable for acoustic signalling in residential and commercial sectors. Finally ESB and EN series of contactors, suitable for loads to be automatically controller through high number of operations. Contactors are used mainly in buildings for switching and controlling lighting, heating, ventilation and pumps. The ESB 24, 40, 63 contactors are used for the control of loads up to 24, 40, 63 A. Due to their DC solenoid actuator, the ESB 24 can be connected to AC or DC voltages. The EN contactors have a built-in toggle switch to select between three function modes: Off position, automatic run (normal contactor function), manual override with a return to Auto the next time the coil is energized.



# Ordering Information

## E 210 switches

3

These devices are specifically made for commanding loads and signalling electrical conditions in any low-voltage switchboard. They are available in half module or 1 module, depending on the contact-layout. The devices with indicator lights are equipped with a LED, which grants an optimal illumination with very low consumption.

The functions of these devices are particularly switching, pushing and signalling electrical conditions in any installations (low-voltage area)

General new features

- Space-saving through 9mm modules
- All terminals equipped with Pozidrive 1 screws
- Safe connection due to cage-clamp
- LED with bright colours and available in three different voltage ranges
- Different lens and button colours
- Compliance to international standards



E211

### E 211-... ON-OFF switches

For example, such devices are used to switch indicators or other electrical components (like fan's, air-conditions, e.g.). The new On-Off switches distinguish themselves through simple handling, easy mounting and optimal functionality.

Rated current = 16A

Cont.	Rated voltage	Power loss	Width	N° module	Bbn 7612270	Order details		Price	Weight 1 piece	Pack unit
	V AC	W	mm	[17.5 mm]	EAN	Type code	Order code		Kg	
1 NO	250	0.32	9	0.5	938575	E211-16-10	2CCA703000R0001		0.035	10
2 NO	230/400	0.82	9	0.5	938582	E211-16-20	2CCA703005R0001		0.045	10



E211X

### E 211X-... ON-OFF switches with yellow LED for contact indication

Rated current = 16A

LED voltage 115-250 V AC

LED colour yellow

Cont.	Rated voltage	Power loss	Width	N° module	Bbn 7612270	Order details		Price	Weight 1 piece	Pack unit
	V AC	W	mm	[17.5 mm]	EAN	Type code	Order code		Kg	
1 NO	250	0.50	9	0.5	938872	E211X-16-10	2CCA703100R0001		0.040	10
2 NO	230/400	1.00	18	0.5	938889	E211X-16-20	2CCA703110R0001		0.050	10



E214-16-101

E214-16-202

### E 214-... Group switches (I-0-II, manual-OFF-automatic)

The new Group switches can be used to control the main installation of an emergency supply. Such devices distinguish themselves through simple handling, easy mounting and optimal functionality.

Rated current = 16A

Cont.	Rated voltage	Power loss	Width	N° module	Bbn 7612270	Order details		Price	Weight 1 piece	Pack unit
	V AC	W	mm	[17.5 mm]	EAN	Type code	Order code			
1 CO	250	0.32	9	0.5	938735	E214-16-101	2CCA703025R0001		0.032	10
2 CO	250	0.82	18	1.0	938742	E214-16-202	2CCA703030R0001		0.064	10

#### Technical details

Switching capacity		according to EN 60669-1
Isolating properties		according to EN 60669-2-4; IEC/EN 60947-3
Utilization category		AC-22A; DC-22A acc. IEC/EN60947-3
Short-circuit withstand capacity	[kA]	3
Rated voltage U <sub>n</sub>	[V]	250/400 in accordance with EN 240 in accordance UL 508
Lowest operat. voltage		24 V; 25 mA
Rated current I <sub>n</sub>	[A]	16, 25, 32
LED current	[mA]	5
Rated frequency	[Hz]	50/60
Modules	[No]	0.5 or 1
Sealable		in ON and OFF position
Climatic resistance		according to IEC 60068-2-2 (Dry heat) IEC 60068-2-30 (Damp heat) IEC 60068-2-1 (Cold)
Ambient temperature	[°C/°F]	-25°C/-13°F to +55°C/+131°F
Storage temperature	[°C]	-40°C to +70°C
Connection capacity	[mm <sup>2</sup> ]	rom 1x1 mm <sup>2</sup> to 1x6 mm <sup>2</sup> or 2x2.5 mm <sup>2</sup> massive; flexible up 1x0.75 mm <sup>2</sup> to 2x1.5 mm <sup>2</sup> with connector leve or pin-endconnector
Tightening torque	[Nm]	1.2 - 1.5
Positive opening		according to EN 60204-1
Standards		DIN EN 60669-1 *VDE 0632-1 DIN EN 60669-2-4 *VDE 0632-2-4 UL 508
Approvals		VDE, UL, GOST, CCC

# Ordering Information

## E 210 pushbuttons with and without LEDs

The new products are available in 9 mm widths (= 0.5 modules).  
 The devices can be used in distribution boards and are all distinguished by their simple handling, ease of mounting and optimal functionality. The pushbuttons are used for remote control in all kinds of electrical installation (e.g. public, industrial). The range offers three different voltages.

(Ranges: 12-48 V AC/DC; 115-250 V AC and 110-220 V DC).

3



E215

### E 215-... Pushbuttons

Rated current = 16A

Contacts: 1NO+1NC

Rated voltage: 250 V AC

Power loss W	Button colour	Width mm	N° module [17.5 mm]	Bbn 7612270 EAN	Order details		Price	Weight 1 piece Kg	Pack unit
					Type code	Order code			
0.50	grey	9	0.5	938810	E215-16-11B	2CCA703150R0001		0.042	10
0.50	red	9	0.5	938827	E215-16-11C	2CCA703151R0001		0.042	10
0.50	green	9	0.5	938834	E215-16-11D	2CCA703152R0001		0.042	10



E217

### E 217-... Luminous Pushbuttons (3 different LED colours)

Rated current = 16A

Contacts: 1NO

Rated voltage: 250 V AC

LED Voltage range = 115-250 V AC

Power loss W	LED colour	Width mm	N° module [17.5 mm]	Bbn 7612270 EAN	Order details		Price	Weight 1 piece Kg	Pack unit
					Type code	Order code			
1.10	white	9	0.5	938988	E217-16-10B	2CCA703160R0001		0.050	10
1.10	red	9	0.5	938995	E217-16-10C	2CCA703161R0001		0.050	10
1.10	green	9	0.5	939008	E217-16-10D	2CCA703162R0001		0.050	10



# Ordering Information

## E 210 indicator Lights with LEDs



E219

The new products are available in 9 mm width (= 0.5 modules) and can be used for indicating any operational condition such as signalling loss of a phase.

The range offers three different voltages.

(Ranges: 12-48 V AC/DC; 115-250 V AC and 110-220 V DC).

Rated current = 16A

LED Voltage range = 115-250 V AC

Power loss	LED colour	Width	N° module	Bbn	Order details		Price	Weight	Pack
					7612270				
W		mm	[17.5 mm]	EAN	Type code	Order code	Kg		unit
0.47	white	9	0.5	939282	E219-B	2CCA703400R0001		0.040	10
0.47	red	9	0.5	939299	E219-C	2CCA703401R0001		0.040	10
0.47	green	9	0.5	939305	E219-D	2CCA703402R0001		0.040	10
0.47	yellow	9	0.5	939312	E219-E	2CCA703403R0001		0.040	10
0.47	blue	9	0.5	939329	E219-G	2CCA703404R0001		0.040	10

### Pushbuttons and Indicator lights

Rated Voltage $U_n$	[V]	250/400
Lowest operat. voltage		24 V; 25 mA
Rated current $I_n$	[A]	16
LED current	[mA]	5
Rated frequency	[Hz]	50/60
Modules	[No]	0.5
Tightening torque	[Nm]	1.2 - 1.5
Standards		EN 60669-1; EN 62094-1; UL 508
Approvals		Pushbuttons: VDE, UL, GOST, CCC Indicator lights: VDE, UL, GOST*

\*CCC approval for these Indicator lights not required



# Ordering Information

## E 200 switches



E201



E202



E203



E204

Isolator for panel installation onto DIN rail acc. to DIN EN 60715  
 Mounting depth: 70mm  
 Mounting width: per pole = 17.5mm = 1 module  
 Colour: grey, RAL 7035  
 Colour of switch lever: red RAL 3000 (r); grey RAL 7000 (g)

### Special features

- Fast removal without dismantling of the busbar
- Captive screws with recessed/slotted head, Pozidriv size 2
- Add-on of up to 3 auxiliary contact S2C-H6R possible
- Integrated lay-on edge for labeling system ILS
- Locking device as accessories for unauthorized ON/OFF
- Approval: VDE, CCC, KEMA

N. of poles	Rated current	Rated voltage	Power loss	N° module	Bbn	Order details		Price	Weight	Pack
	A	V AC	W	[17.5 mm]	4016779	Type code	Order code		1 piece	unit
1	16	230	0.15	1	645621	E201/16r	2CDE281001R0016		0.095	10
	25	230	0.30	1	645645	E201/25r	2CDE281001R0025		0.095	10
	32	230	0.50	1	645669	E201/32r	2CDE281001R0032		0.095	10
	40	230	0.70	1	645683	E201/40r	2CDE281001R0040		0.095	10
	45	230	0.90	1	645706	E201/45r	2CDE281001R0045		0.095	10
	63	230	1.65	1	645720	E201/63r	2CDE281001R0063		0.095	10
2	16	400	0.30	2	645805	E202/16r	2CDE282001R0016		0.190	5
	25	400	0.60	2	645829	E202/25r	2CDE282001R0025		0.190	5
	32	400	0.95	2	645843	E202/32r	2CDE282001R0032		0.190	5
	40	400	1.40	2	645867	E202/40r	2CDE282001R0040		0.190	5
	45	400	1.80	2	645881	E202/45r	2CDE282001R0045		0.190	5
	63	400	3.30	2	645904	E202/63r	2CDE282001R0063		0.190	5
3	16	400	0.45	3	645980	E203/16r	2CDE283001R0016		0.290	3
	25	400	0.90	3	646000	E203/25r	2CDE283001R0025		0.290	3
	32	400	1.40	3	646024	E203/32r	2CDE283001R0032		0.290	3
	40	400	2.10	3	646048	E203/40r	2CDE283001R0040		0.290	3
	45	400	2.65	3	646062	E203/45r	2CDE283001R0045		0.290	3
	63	400	4.90	3	646086	E203/63r	2CDE283001R0063		0.290	3
4	16	400	0.60	4	646161	E204/16r	2CDE284001R0016		0.390	2
	25	400	1.20	4	646185	E204/25r	2CDE284001R0025		0.390	2
	32	400	1.90	4	646208	E204/32r	2CDE284001R0032		0.390	2
	40	400	2.80	4	646222	E204/40r	2CDE284001R0040		0.390	2
	45	400	3.50	4	646246	E204/45r	2CDE284001R0045		0.390	2
	63	400	6.55	4	646260	E204/63r	2CDE284001R0063		0.390	2

**E 200**

Switching capacity	1.25 x In; 1.1 x Un; cosφ = 0.3 acc. to DIN VDE 0632 16...100 A : AC-22A / 125 A : AC-23A acc. to VDE 0660 part 107, DIN EN 60947-3 resp. IEC 947-3, DC21-B for applications up to 60 V DC
Protection fuse	NH00 gL-gG ≤ rated current E 200
Positive opening	acc. to DIN VDE 0113
Suitable for isolation	acc. to DIN EN 60947-3
Short-circuit withstand capacity	16...100 A : 25 kA <sub>eff</sub> in series with NH 00 ≤ 100 A gL-gG; 125 A : 6 kA <sub>eff</sub> in series with NH 00 125 A gL-gG and S 2.. ≤63 A
Rated voltage	230/400 V AC; 50/60 Hz
Surge withstand capability U <sub>imp</sub>	4 kV acc. to EN 60947-1
Ambient temperature	-25 °C to +55 °C
Storage temperature	-40 °C to +70 °C
Climatic resistance	constant climate 23/83, 40/93, 55/20 [°C/RH] alternating climate 25/95 - 40/93 [°C/RH]
Mounting position	optional
Degree of protection	IP10, IP40 in panelboard
Mechanical endurance	20000 switching cycles
Electrical endurance	1000 switching cycles
Min. voltage	12 V AC/DC at 0.1 VA
Min. contact loading	24 V/4 mA
Wire range	2.5 to 50 mm <sup>2</sup>
Busbars	cross section ≥ 16 mm <sup>2</sup>
Torque	2.5 Nm

# Ordering Information

## E 250 latching relays



2CSC400030FF0112

3

E251

Allow switching of the contacts in response to each pulse sent to the coil via the normally open pushbuttons. Their high performance in the single or multi-point control of lamps make them an ideal solution for lighting circuits. The manual control lever also gives an indication of the contact position.

The relays come in versions with different coil voltages and contact configurations. The main modules, available in one-and two-contact versions, can be combined with two-pole power contact modules to obtain three-contact and four-contact devices. They can also be provided with auxiliary signal contacts.

### E 250, 16 A

Contacts	Coil voltage	N° module [17.5 mm]	Bbn 8012542 EAN	Order details		Price	Weight 1 piece Kg	Pack unit
				Type code	Order code			
1 NO	230 V AC/ 115 V DC	1	530305	E251-230	2CSM111000R0201		0.114	12
2 NO	230 V AC/ 115 V DC	1	530800	E252-230	2CSM112000R0201		0.116	12

## Technical details

Rated current $I_n$		[A]	16	32	
Rated voltage $U_n$		[V]	250 (1-2 contacts) 400 (3-4 contacts)	250 (1-2 contacts) 400 (3-4 contacts)	
Rated frequency		[Hz]	50/60 <sup>(1)</sup>	50/60 <sup>(1)</sup>	
Contacts	main module	NO	1 - 2	1 - 2	
		change-over	1 - 2	1 - 2	
		NO+NC	1 + 1	1 + 1	
	additional power contacts	NO	2	2	
		change-over	2	-	
		NO+NC	1+1	-	
Width	main module	[mod.]	1	1	
(no. of DIN modules)	with additional power contacts	[mod.]	2	2	
Control coil characteristics	supply voltage: DC/AC ratio <sup>(2)</sup>			0,5 : 1	
	tolerance on supply voltage			±10%	
	power consumption AC	holding <sup>(3)</sup>	[VA]	11	11,5
		pick-up	[VA]	14,5	16,5
		power consumption DC	[W]	7,5	8
Pulse durations	minimum pulse duration (at $U_n$ )		[s]	0,05	
	minimum pulse duration (90% $U_n$ )		[s]	0,1	
	minimum interval between two pulses		[s]	0,15	
	maximum number of pulses per minute			250	
Lifetime in number of operations <sup>(4)</sup>	electrical (in AC-1 at full load)			$4 \times 10^5$	
	mechanical			$2 \times 10^6$	
Load characteristics	maximum load in AC-1 per phase		[A]	20	
	minimum load per phase (under 5 V)		[W]	2	
	short circuit protection fuse (gL)		[A]	20	
Maximum no. of lamps (103 operations/h)	incandescent and halogen		[W]	3000	
	fluorescent, corrected power factor ( $\cos\phi = 0,9$ )	series	[VA]	4000	
		parallel	[VA]	2500	
	fluorescent, uncorrected power factor ( $\cos\phi = 0,5$ )		[VA]	1800	
Maximum number of buttons	non illuminated			unlimited	
	illuminated	3 wires		unlimited	
General characteristics	DIN rail mount			yes	
	hooking on bistable DIN rail			yes	
	two position knob			yes	
	contact position indication			yes	
	label-holder			yes	
	cage terminals			yes	
	captive screws			yes	
	sealable terminals			yes	
	cable section (o min./max.)		[mm <sup>2</sup> ]	1,5/10 (2P: 6)	
	min./max. operating temperature		[°C]	-20...+45	

<sup>(1)</sup> All latching relays can also be used at 60Hz. In this case and excluding E255, you can use maximum one auxiliary contact E250H but it is not possible to use power contacts E250CM.

<sup>(2)</sup> Supply voltage: all devices operate in both a.c. and d.c., with the specified voltage ratios, except for the 115 V a.c. version that operates at 48 V d.c..

<sup>(3)</sup> The relays can withstand the "button stuck" condition. When the application calls for the relays to be permanently supplied, spacers must be used on either side, making sure that the duty cycle allows the device to cool down to ambient temperature.

<sup>(4)</sup> 1 cycle = 2 operations per pole (closing + opening)

# Ordering Information

## E 260 electronic latching relays



2CSC400030F0113

E262



2CSC400030F0114

E262C

The electronic version of latching relays guarantees maximum reliability, life, and noiseless operation. The E 260 C version also allows centralized reset function (ON/OFF).

### Latching relays with control electronics

Coil voltage  $U_c = 230 \text{ V AC}$

Contacts	Power loss	N° module [17.5 mm]	Bbn 4016779	Order details		Price	Weight 1 piece Kg	Pack unit
	W*		EAN	Type code	Order code			
1 NO	1.5 (2.0)	1	575966	E261-230	2CDE141000R0301		0.085	1
2 NO	1.7 (3.6)	1	575973	E262-230	2CDE142000R0301		0.096	1
1 NO+1 NC	1.7 (3.6)	1	575980	E266-230	2CDE144000R0301		0.096	1

### Latching relays with control electronics for central ON/OFF switch

The central commands have always priority and reliably switch on/off any given number of devices connected in parallel, irrespective of their previous switching position. Local control inputs are blocked when a central command is received. Same potential at central / local control input.

Coil voltage  $U_c = 230 \text{ V AC}$

Contacts	Power loss	N° module [17.5 mm]	Bbn 4016779	Order details		Price	Weight 1 piece Kg	Pack unit
	W*		EAN	Type code	Order code			
1 NO	1.5 (2.0)	1	576024	E261C-230	2CDE141000R0311		0.085	1
2 NO	1.7 (3.0)	1	576031	E262C-230	2CDE142000R0311		0.096	1
1 NO+1 NC	1.7 (3.0)	1	576048	E266C-230	2CDE144000R0311		0.096	1

\* Values in brackets indicate power loss when permanently excited, rated voltage and rated contact loading.

	E 260/E 260 C	E 261 SRV-230
<b>Technical details</b>		
Rated load at 250 V AC	8 A	16 A
Incandescent lamp load	1000 W	1600 W
Fluorescent lamp load in twin-lamp circuit	1000 W	1000 W
Fluorescent lamp load shunt compensated	350 W <sup>(1)</sup>	500 W
Fluorescent lamp load inductive or capacitive	500 W	1000 W
Electronic ballast	$I_{on}$ m 70 A/10 ms <sup>(2)</sup>	$I_{on}$ m 70 A/10 ms <sup>(2)</sup>
Inductive load, $\cos\phi = 0.6/230$ V ~	5 A	5 A
Contact rating at DC	100 W	100 W
Minimum contact rating	4 V AC/10 mA	4 V AC/10 mA
Contact gap/contact material	0.5 mm/Ag SnO <sub>2</sub>	0.5 mm/Ag SnO <sub>2</sub>
Service life mechanical switchover at 103/h	> 10 <sup>7</sup>	> 10 <sup>7</sup>
Service life at rated load $\cos\phi = 1$ and 103/h	> 10 <sup>5</sup>	> 10 <sup>5</sup>
Service life with filament lamps at 103/h	800 W > 10 <sup>5</sup> , 1000 W > 0.8x10 <sup>5</sup>	1000 W > 10 <sup>5</sup>
Service life at rated load $\cos\phi = 0.6$ and 103/h	> 10 <sup>4</sup>	> 10 <sup>4</sup>
Max. switching rate	10 <sup>3</sup> /h	10 <sup>3</sup> /h
Bounce time	3 ms	
Connection capacity	2 x 1.5 mm <sup>2</sup> with connector sleeve 2 x 2.5 mm <sup>2</sup> without connector sleeve	
Tightening torque	0.5 ... 0.8 Nm	0.5 ... 0.8 Nm
ON duration at rated voltage	100 %	100 %
Coil voltage range	0.9 to 1.1 U <sub>n</sub>	0.9 to 1.1 U <sub>n</sub>
Minimum command time/interval between commands	50/1000 ms	50 ms
Ambient temperature	-20 °C / -4 °F to 50 °C / 122 °F	-20 °C / -4 °F to 50 °C / 122 °F
Control current when controlled locally	230 V AC 115 mA, after 10s 8 mA ± 20 % 24 V UC 140 mA, after 10s 80 mA ± 20 %	
Control current when controlled centrally	230 V AC 8 mA, after 10s 3 mA ± 20 % 24 V UC 17 mA ± 20 %	
Max. parallel capacity of individual control wire at 230 V ~	0.7 µF (ca. 2000 m)	
Max. parallel capacity of central control wire at 230 V ~	0.2 µF (ca. 700 m)	
Max. glow lamp current – parallel to 230 V control buttons	10 mA	10 mA
Max. induced voltage at 230 V control inputs	0.2 U <sub>n</sub>	120 V

Latching relays for lamp installations on request.

<sup>(1)</sup> E 260 C can not be used with fluorescent lamp load shunt compensated.

<sup>(2)</sup> In the case of electronic control gear, take into account a 40-fold inrush current.

# Ordering Information

## FLR flush mounting latching relays



FLR

2CSC400030D0115

Speed and ease of assembly, along with their compact size, make the FLR flush mounting latching relays suitable for installation inside flush mount or junction boxes. They are ideal for implementing multipoint command of lighting systems in residential and commercial installations, so as to simplify and reduce the cost of wiring.

Contacts	N° module [17.5 mm]	Bbn 8012542 EAN	Order details		Price	Weight 1 piece Kg	Pack unit
			Type code	Order code			
1	-	063759	FLR1-230	2CSM206375R0241		0.060	20
2	-	063957	FLR5-230	2CSM206395R0241		0.060	20

### FLR1

### FLR5

#### Technical details

		FLR1	FLR5
Contact type		1NO	2NO
Number of sequences	[No.]	2	4
Rated voltage	[V]	12 / 230 AC	
Rated load		10 A / 250 V AC	
Max. Peak current	[A]	15	
Max. switching power	[VA]	2500	
Max. switching voltage	[V]	250 AC	
Incandescent lamp load	[W]	805	
Fluorescent lamp load	[W]	345	
Frequency	[Hz]	50-60	
Type of operation		sequential - mechanical	
Protection degree		IP20	
Max. number of electrical operations	[No.]	100000	
Max. number of mechanical operations	[No.]	300000	
Insulation resistance	[MΩ]	100 (500 V DC)	
Dielectric strength (contacts)	[V]	2000 AC	
Dielectric strength (coil)	[V]	3500 AC	
Power dissipation	[VA]	4.5	
Operating temperature	[°C]	-25...+55	
Max. Cable section at terminals	[mm²]	1..2.5	
Terminals		screw	
Installation type		wall/flush mounting	
Dimensions (LxWxH)	[mm]	45 x 22 x 45	
Standards		EN 60669-1; EN 60669-2-1	



# Ordering Information

## E 259 installation relays



E259

E 259 Installation relays are 16 A contactors specifically engineered for residential and commercial applications. Their high performance in the control of lamps makes them ideal for lighting circuit applications.

The front control lever indicates the position of the contacts and allows the relay to be commanded, for example for local testing of the circuit.

In installations that require several E 259 relays side by side, it is advisable to use E 259 DIS half-module width spacer elements every second relay for heat dissipation.

Contacts	Coil voltage	N° module [17.5 mm]	Bbn 8012542	Order details		Price	Weight 1 piece Kg	Pack unit
			EAN	Type code	Order code			
1 NO	230 V AC / 115 V DC	1	735939	E259 16-10/230	2CSM273593R0401		0.100	12
2 NO	230 V AC / 115 V DC	1	736233	E259 16-20/230	2CSM273623R0401		0.100	12
1 NO+1NC	230 V AC / 115 V DC	1	736530	E259 16-11/230	2CSM273653R0401		0.100	12

### E 259

#### Technical details

Rated voltage $U_n$		[V]	250	
Rated frequency		[Hz]	50	
Rated current in AC1/AC-7a		[A]	16	
Control coil characteristics	AC power supply voltage	[V]	8, 12, 24, 48, 115, 230	
	DC power supply voltage	[V]	6, 12, 24, 48, 115	
	DC/AC ratio <sup>(1)</sup>		0.5 : 1	
	operation limits		±10%	
power consumption AC	pick-up	[VA]	3.4	
	holding	[VA]	1.8	
power consumption DC		[W]	2.1	
Load characteristics per phase	maximum load AC-1	[kW]	3	
	maximum load AC-5b	[kW]	1.8	
	maximum load AC-7b	[kW]	0.9	
	maximum load AC-3 (400V)	[kW]	-	
	maximum load (under 5V)	[W]	2	
	short circuit fuse protection [gL]	[A]	20	
Lifetime in number of operations	electrical (in AC-1 at full load)	[No.]	3 x 10 <sup>5</sup>	
	mechanical	[No.]	2 x 10 <sup>6</sup>	
Max.lamp power	Incandescent and halogen (40-200W)		[W]	1800
	Fluorescent	Parallel p.f. correction (cosφ=0.9)	[VA]	500
		p.f. uncorrected (cosφ=0.5)	[VA]	900
Width (number of DIN modules)		[No.]	1	
Cable cross section (Ø min/max)		[mm <sup>2</sup> ]	1.5 / 10	
Maximum torque on terminals		[Nm]	1	
Min./Max. ambient T ° at installation point		[°C]	-20 ... +45	
Standard			IEC EN 60947-4-1, IEC EN 61095	

<sup>(1)</sup> Control coil voltage: all the products work both in AC and DC (with the specified ratio) except the 115 V AC version that works at 48 DC

# Ordering Information

## SM/RM bells and buzzers



3

SM1

The range of bells and buzzers includes modular versions for discontinuous use SM1, RM1, TSM and TSR, suitable for acoustic signalling in residential and commercial sectors, and versions for continuous use SM2 and RM2, which are able to operate continuously for up to 12 hours while maintaining the quality and level of the sound. RM2 and SM2 are dedicated to specific applications such as acoustic signalling in the industry, alarms notification, supervision and intensive use (schools, factories etc...). TSM and TSR versions also include a transformer: the input is 230V a.c. and the bell is supplied in 12 or 24 V.

Rated voltage	Use	N° module	Bbn 8012542	Order details		Weight 1 piece	Pack unit
V AC		[17.5 mm]	EAN	Type code	Order code	Price Kg	
<b>SM electro-mechanical modular bells</b>							
8/12	Discontinuous	1	886204	SM1-12	2CSM111000R0821		0.076 12
230	Discontinuous	1	886303	SM1-230	2CSM131000R0821		0.076 12
<b>RM electro-mechanical modular buzzers</b>							
8/12	Discontinuous	1	886419	RM1-12	2CSM211000R0821		0.076 12
230	Discontinuous	1	886518	RM1-230	2CSM231000R0821		0.076 12

			SM1-12, RM1-12	SM1-230, RM1-230
<b>Technical details</b>				
Rated Voltage $U_n$	[V AC]		8-12	230
Rated frequency	[Hz]		50	50
Power consumption	[VA]		2,5-6,5	4,5
Sound level at 1 meter	SM: [dB]		82	82
	RM: [dB]		80	80
Max permanent working time			15 min	15 min
Max cable cross-section	[mm <sup>2</sup> ]		10	10
Mounting position			vertical only	
Protection degree			IP20-IP40, switchboard mounting	
Modules	[No.]		1	1

# Ordering Information

## ESB installation contactors



ESB 20-20



ESB 24-40



ESB 63-40

Application: the ESB contactors are used mainly in buildings for switching and controlling lighting, heating, ventilation and pumps. They are part of the complete range of Din rail products and can be integrated easily in dedicated panels.

ESB20 are AC coil operated.

The ESB 24, 40, 63 contactors are used for the control of loads up to 24, 40, 63 A.

Due to their DC solenoid actuator, the ESB 24 can be connected to AC or DC voltages.

This provides the following benefits:

Hum-free operating system, no vibration, silent in operation, low power consumption, integrated high overvoltage protection 5 kV. You can choose between a various N.O. and N.C. contacts combination.

Main accessories for ESB 24, 40, 63: auxiliary contact blocks EH04.

Main poles	Control coil voltage		N° module [17.5 mm]	Bbn 3471520 EAN	Order details		Price	Weight 1 piece Kg	Pack unit
	50 Hz	60 Hz			Type code	Order code			
<b>ESB 20</b>									
2 NO	230 V	264 V	1	263263	ESB 20-20	GHE 321 1102 R0006		0.140	10
2 NC	230 V	264 V	1	263867	ESB 20-02	GHE 321 1202 R0006		0.140	10
1 NO	230 V	264 V	1	263560	ESB 20-11	GHE 321 1302 R0006		0.140	10
1 NC									

Main poles	Control coil voltage		N° module [17.5 mm]	Bbn 4013614 EAN	Order details		Price	Weight 1 piece Kg	Pack unit
	40...450 Hz	DC			Type code	Order code			
<b>ESB 24</b>									
2 NO	230...240 V	230...240 V	2	146756	ESB 24-20	GHE 329 1402 R0006		0.280	5
4 NO	230...240 V	230...240 V	2	084454	ESB 24-40	GHE 329 1102 R0006		0.280	5
4 NC	230...240 V	230...240 V	2	084546	ESB 24-04	GHE 329 1202 R0006		0.280	5
<b>ESB 40</b>									
4 NO	230...240 V	230...240 V	3	084867	ESB 40-40	GHE 349 1102 R0006		0.400	3
<b>ESB 63</b>									
4 NO	230...240 V	230...240 V	3	084973	ESB 63-40	GHE 369 1102 R0006		0.420	3

# Ordering Information

## ESB installation contactors

3

		ESB20 (AC operated)	ESB24 (AC/DC operated)	ESB40 (AC/DC operated)	ESB63 (AC/DC operated)
<b>Technical details</b>					
<b>Main Pole - Utilization Characteristics according to IEC</b>					
Rated operational voltage $U_e$ max.	V	250	400		
Rated frequency limits	Hz	50/60	40...450		
Utilization category AC-1 / AC-7a					
for air temperature close to contactor < 55 °C (NO)	A	20	24	40	63
Max. rated operational current $I_e$ AC-1 / AC-7a (NC)	A	20	24	30	30
Rated operational power AC-1					
230 V - 1 phase	kW	4	5.3	8.8	13.8
400 V - 3 phases	kW	-	16	26	41
Utilization category AC-3 / AC-7b for air temperature close to contactor < 55 °C					
Max. rated operational current $I_e$ AC-3/AC-7b					
230 V - 1 phase	A	9	9	22	30
400 V - 3 phases	A	-	9	22	30
Rated operational power AC-3					
230 V - 1 phase	kW	1.1	2.2	5.5	8
400 V - 3 phases	kW	-	4	11	15
Rated making capacity AC-3					
		$10 \times I_e / AC-3$			
Rated breaking capacity AC-3					
		$8 \times I_e / AC-3$			
Short-circuit protection for contactors gG type fuse	A	20	35	63	80
Rated short-time withstand current $I_{cw}$ at 40 °C ambient temp., in free air, from a cold state 10 s	A	72		176	240
Heat dissipation per pole $I_e/AC-1/AC-7a$	W	1	1.5	3	6
Max. electrical switching frequency					
- for AC-1 / AC-7a	cycles/h	300			
- for AC-3 / AC-7b	cycles/h	600			
Electrical durability					
- for AC-1 / AC-7a	cycles	150000	150000	150000	150000
- for AC-3 / AC-7b	cycles	150000	500000	170000	240000
Mechanical durability					
- millions of operating cycles		1.000.000			
<b>Magnet System Characteristics</b>					
Coil operating limits acc. to IEC 60947-4-1		0.85 ... 1.1 x $U_e$ (at $\theta_m$ 55 °C)			
Drop-out voltage in % of $U_c$		approx. 20 ... 75 %	approx. 20 ... 70 %		
Frequency range	Hz	50/60	40 ... 450		
Coil consumption					
Average pull-in value	VA/W	8 / 5	4 / 4	5 / 5	65 / 65
Average holding value	VA/W	3.2 / 1.2	4 / 4	5 / 5	4.2 / 4.2
<b>Connecting Characteristics</b>					
Connecting capacity (min. ... max.)					
Main pole terminals					
Rigid	1 x mm <sup>2</sup>	1.5 ... 10	-	1.5 ... 25	-
	2 x mm <sup>2</sup>	1.5 ... 4	-	1.5 ... 10	-
Degree of protection acc. to IEC 60947-1 / EN 60947-1 and IEC 60529 / EN 60529 Protection against direct contact in acc. with EN 50274					
All terminals		IP20	-	IP20	-

# Ordering Information

## EN series contactors



2CSC4003039F0121

EN 20-20



2CSC4003039F0122

EN 24-40



2CSC4003039F0123

EN 40-40

Application: the EN contactors are used mainly in buildings for switching and controlling lighting, heating, ventilation and pumps. They are part of the complete range of Din rail products and can be integrated easily in dedicated panels.

Description: EN contactors have a built-in toggle switch to select between three function modes: Off position, automatic run (normal contactor function), manual override with a return to Auto the next time the coil is energized.

This offers many advantages as: You can make functional test before installation start-up. It can be used for maintenance operation, to change lamps and test it. It provides higher safety and drop out as you can switch the application manually.

The toggle switch is also used for household application like water heating where double tariff of kWh is used.

Main poles	Control coil voltage		N° module	Bbn 3471520	Order details		Price	Weight 1 piece Kg	Pack unit
	50 Hz	60 Hz			Type code	Order code			
<b>EN 20</b>									
2 NO	230 V	264 V	1	265069	EN 20-20	GHE 322 1101 R0006		0.140	10

Main poles	Control coil voltage		N° module	Bbn 4013614	Order details		Price	Weight 1 piece Kg	Pack unit
	40...450 Hz	DC			Type code	Order code			
<b>EN 24</b>									
4 NO	230...240 V	230...240 V	2	133688	EN 24-40	GHE 326 1101 R0006		0.240	5
3 NO	230...240 V	230...240 V	2	134319	EN 24-30	GHE 326 1501 R0006		0.230	5
<b>EN 40</b>									
2 NO	230...240 V	230...240 V	3	129582	EN 40-20	GHE 342 1401 R0006		0.400	3
3 NO	230...240 V	230...240 V	3	212338	EN 40-30	GHE 342 1501 R0006		0.400	3
4 NO	230...240 V	230...240 V	3	133701	EN 40-40	GHE 342 1101 R0006		0.410	3

# Ordering Information

## EN series contactors

3

		EN20 (AC operated)	EN24 (AC/DC operated)	EN40 (AC/DC operated)
<b>Technical details</b>				
Main Pole - Utilization Characteristics according to IEC				
Rated operational voltage $U_e$ max.	V	250	400	
Rated frequency limits	Hz	50/60	40...450	
Utilization category AC-1 / AC-7a				
for air temperature close to contactor < 55 °C (NO)	A	20	24	40
Max. rated operational current $I_e$ AC-1 / AC-7a (NC)	A	20	24	30
Rated operational power AC-1				
230 V - 1 phase	kW	4	5.3	8.8
400 V - 3 phases	kW	-	16	26
Utilization category AC-3 / AC-7b for air temperature close to contactor < 55 °C				
Max. rated operational current $I_e$ AC-3/AC-7b				
230 V - 1 phase	A	9	9	22
400 V - 3 phases	A	-	9	22
Rated operational power AC-3				
230 V - 1 phase	kW	1.1	2.2	5.5
400 V - 3 phases	kW	-	4	11
Rated making capacity AC-3				
$10 \times I_e / AC-3$				
Rated breaking capacity AC-3				
$8 \times I_e / AC-3$				
Short-circuit protection for contactors gG type fuse	A	20	35	63
Rated short-time withstand current $I_{cw}$ at 40 °C ambient temp., in free air, from a cold state 10 s	A	72		176
Heat dissipation per pole $I_e/AC-1/AC-7a$	W	1	1.5	3
Max. electrical switching frequency				
- for AC-1 / AC-7a	cycles/h	300		
- for AC-3 / AC-7b	cycles/h	600		
Electrical durability				
- for AC-1 / AC-7a	cycles	150000	150000	150000
- for AC-3 / AC-7b	cycles	150000	500000	170000
Mechanical durability				
- millions of operating cycles		1.000.000		

# Ordering Information

## EH04... auxiliary contact block



EH 04

Contactor Type	Contact blocks		N° module [17.5 mm]	Bbn 3471520	Order details		Price	Weight 1 piece Kg	Pack unit
				EAN	Type code	Order code			
ESB/EN 24, 40, 63	2	-	0.5	084768	EH 04-20	GHE 340 1321 R0001		0.004	10
	1	1	0.5	084768	EH 04-11	GHE 340 1321 R0002		0.004	10

ESB20 (AC operated)	ESB24 (AC/DC operated)	ESB40 (AC/DC operated)	ESB63 (AC/DC operated)
------------------------	---------------------------	---------------------------	---------------------------

### Technical details

Rated operational voltage $U_g$ max.	V	-	500
Conventional free air thermal current $I_{th}$ $\theta < 40$ °C	A	-	6
Rated frequency limits	Hz	-	50/60
Rated operational current $I_g$ / AC-15 acc. to IEC 60947-5-1			
240 V 50/60 Hz	A	-	4
415 V 50/60 Hz	A	-	3
500 V 50/60 Hz	A	-	2
Making capacity acc. to IEC 60947-5-1		-	11 x $I_g$ AC-15
Breaking capacity acc. to IEC 60947-5-1		-	11 x $I_g$ AC-15
Short-circuit protection gl type fuse	A	-	10
Minimum switching capacity with failure rate acc. to IEC 60947-5-4	V/mA	-	17 / 5
Heat dissipation per pole at 6 A	W	-	0.1



# Overall dimensions

## E 210 - Switches, pushbuttons and indicator lights

3

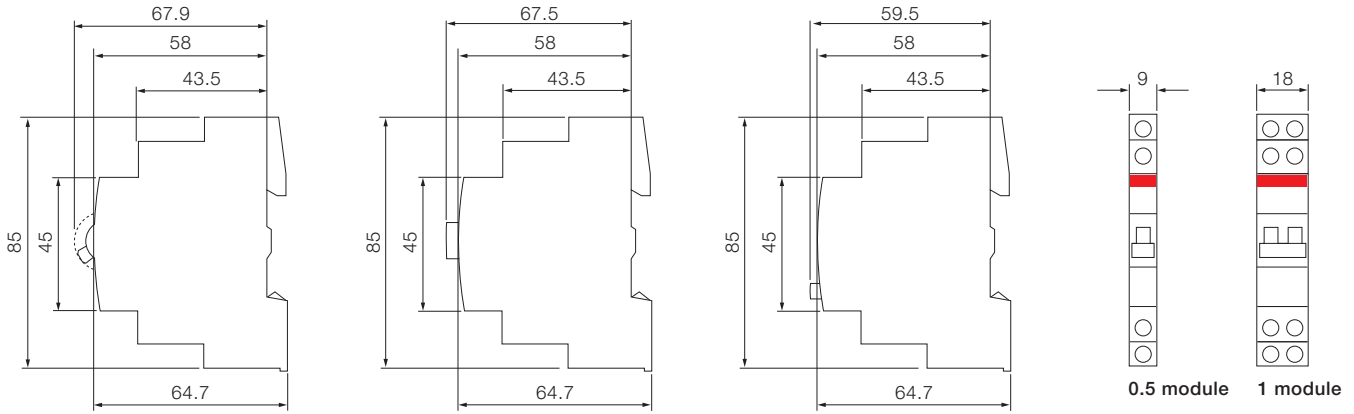

## E 200

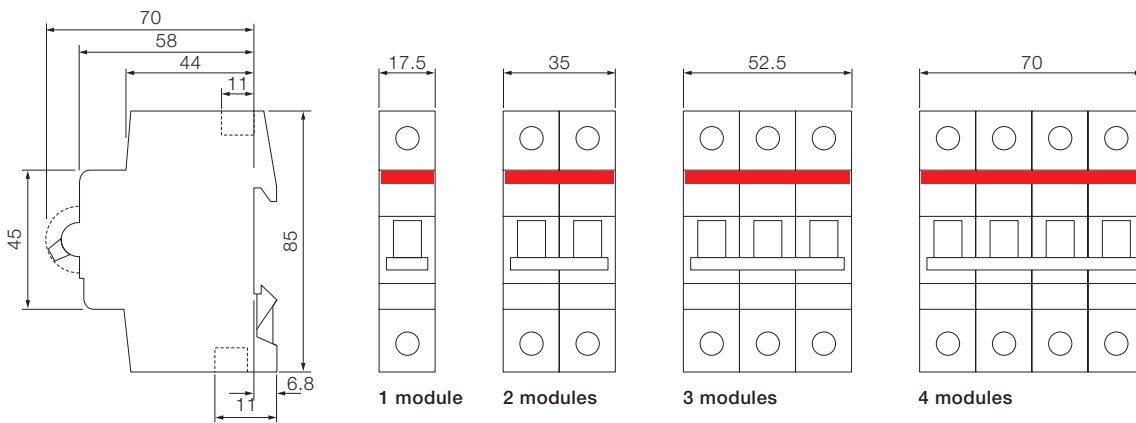

## E 250

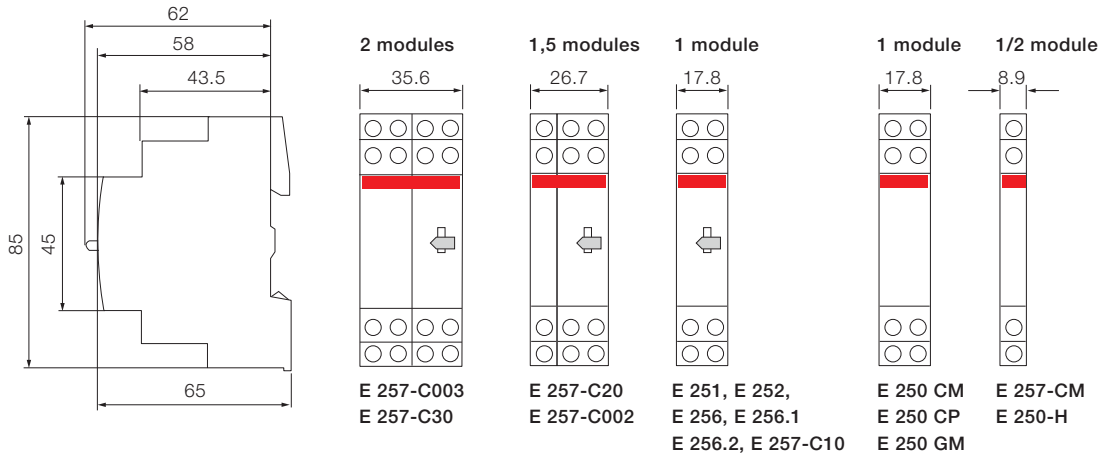

## E 260

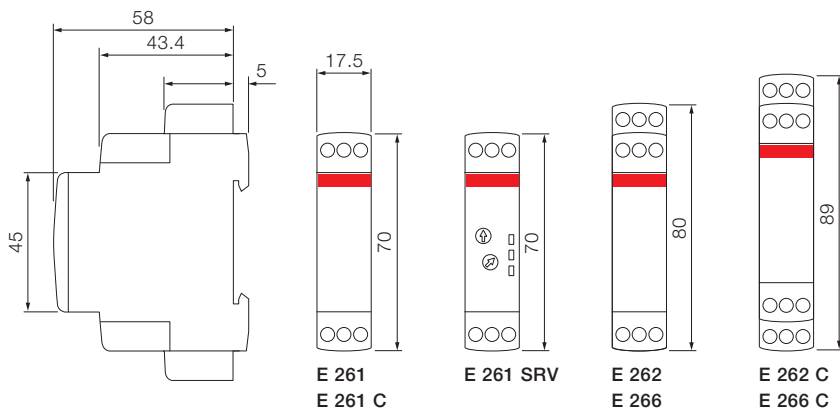

## FLR

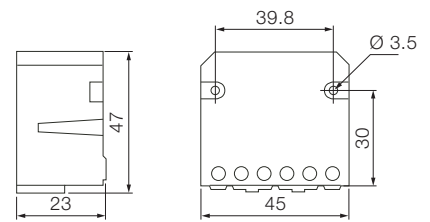

## E 259

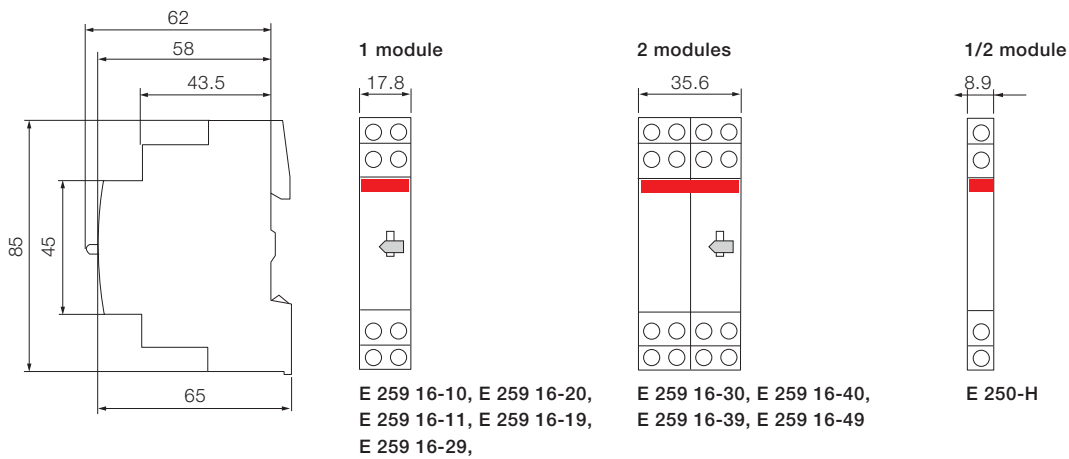

# Overall dimensions

## SM, RM

3

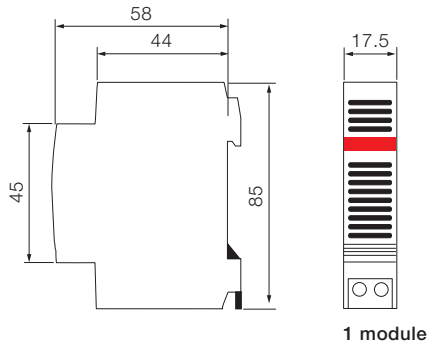

## ESB/EN contactors

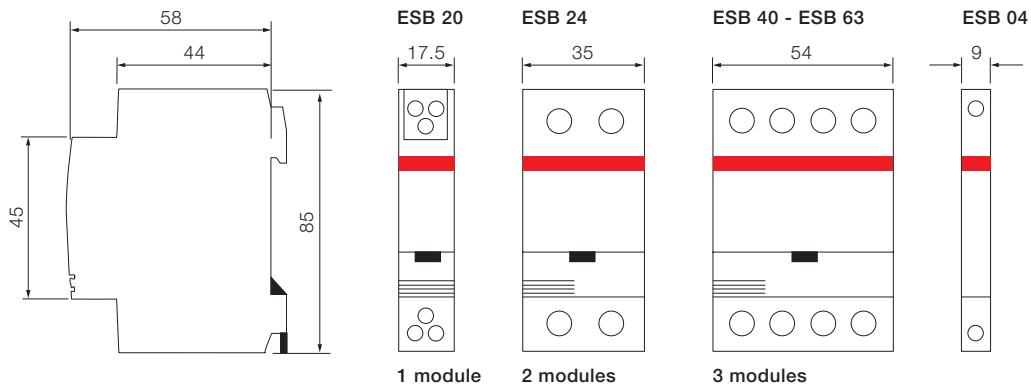

Introduction	4/2
--------------	-----

Plus of range	4/4
---------------	-----

### Ordering information

F2C-ARH and F2C-ARH-T	4/6
-----------------------	-----

E 450	4/7
-------	-----

ATT	4/8
-----	-----

RAL	4/10
-----	------

LSS1/2	4/11
--------	------

E 235	4/12
-------	------

Socket outlets	4/13
----------------	------

LEE 230	4/14
---------	------

Overall dimensions	4/15
--------------------	------

# Comfortable living, easy to manage ABB solutions for home comfort

The basic idea behind a modern electrical installation is to adapt the system to the users' needs and not vice versa, providing simple operation, safety and energy efficiency. ABB products have all the necessary features to control homes through a flexible networking of solutions that make life easy.

4

Electronic components have always been used to improve the performance, increase comfort and save energy.

Even in domestic installations, loads must be protected and monitored to guarantee their correct behaviour in critical conditions. This is a fundamental aspect for the comfort of users. The ABB's portfolio of products devoted to improve the comfort is very complete.

The F2C-ARH-T autoreclosing unit for domestic and similar application periodically performs the auto test and reclosure of the associated residual current device (2-pole

RCCBs up to 63 A - 30 mA / 100 mA), only after having checked that there are no effective faults in the system protected by the RCCB.

The ATT modules are GSM telephone actuators for remotely controlling electrical loads over the mobile phone network, which answer the installation requirements of a variety of application settings. Instructions and alarms can be sent via SMS message, free phone call ring, fax or e-mail according to need. Configuration can be accomplished by SMS messages or using the ATT-Tool software.



Modular devices in the load management devices category react automatically to variations of parameters and other events in the system to allow installation optimization. The priority switch is used in wiring systems where existing lead cross sections or the size of the power supply service box. The E 450 priority switches in particular disconnects the long-term load as long as the short-term consumer is switched on. Installed downstream of the main circuit-breaker, LSS1/2 load shedding switch compares the actual power consumption of the system to a preset maximum permitted value, and prevents tripping of the main circuit-breaker by sequentially switching off a maximum of two non-priority loads (NPL1 and NPL2) when the preset threshold is exceeded. A green LED indicates the presence of the supply voltage, and two red LEDs indicate the load OFF conditions. At preset time intervals, the device automatically attempts to reconnect the previously disabled loads.

E 235 mains disconnection relays – Bioswitch - constant exposure of electrical interference fields originating from live conductors - as is the case e.g. in bedrooms – which may impair the well-being of people.

LEE 230 extractable power failure signalling lamp is an automatic electronic lamp that can be installed in any modular socket or wiring accessory socket conforming to the German VDE Schuko standard, to the Italian standard P11 10A, or to the 10/16 A Italian dual standard. The device functions both as a power failure signalling lamp and as a lighting device, to be used for example during maintenance activities or when seeking faults in the panel.



# F2C-ARH and F2C-ARH-T

The details make the difference

The characteristics and assets of an efficient and reliable product

4

Supply cables of the device

Plastic prong to couple Greenlight to the residual current circuit-breaker

Coupler that connects to the operating lever of the RCCB

Slide that activates/ de-activates the automatic resetting function

Wiring cables of the device

Autotest programming key (only on F2C-ARH-T)

Selector switch for activating the RCCB's automatic test function (only on F2C-ARH-T)

Indicator LED

Withdrawable terminals to connect the auxiliary signalling contact





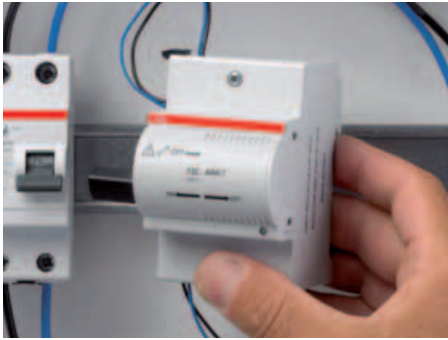

**Wiring**

Greenlight auto-reclosing units are supplied already wired and ready to be installed and connected. You only need a screwdriver to turn the hooks that fasten it to the circuit-breaker and to tighten the terminals. The four wires of the Greenlight device are specially designed to be simply and reliably connected to the rear terminals of FH202 30 mA / 100 mA residual current circuit-breaker.

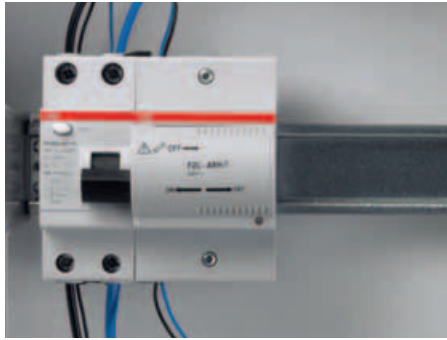

**Set-up**

Just a few minutes for the assembly, connection and programming procedures: Greenlight can be activated within an exceptionally short time. The operations are so simple that there is absolutely no room for error and the first autotest (available on F2C-ARHT), already included in the start-up procedure, allows you to immediately make sure that the system is working in an efficient and reliable way.



**Autotest programming (only on F2C-ARH-T)**

Once Greenlight with autotest has been assembled and connected, just power it, close the residual current circuit-breaker and move the slide towards the left to free the programming button. The red LED alongside the programming button will flash to indicate that the autotest needs to be programmed. Keep pressed the programming button for three seconds. The red LED light will become fixed and the device will perform the first test. The test will be repeated, at the same time of day, every six months.



Colour	State	Auxiliary contact	Meaning
None	Off	Open	Greenlight not powered
Green	Flashing	Open	Greenlight powered and auto-reclosing not activated
Green	Fixed	Open	Auto-reclosing activated
Red	Flashing	Open	Inspection of the installation after the RCCB has tripped
Red	Fixed	Closed	Greenlight has blocked owing to a permanent fault in the line
Orange (only on F2C-ARH-T)	Fixed	Open	The RCCB automatic test has given a negative result: call an electrician.

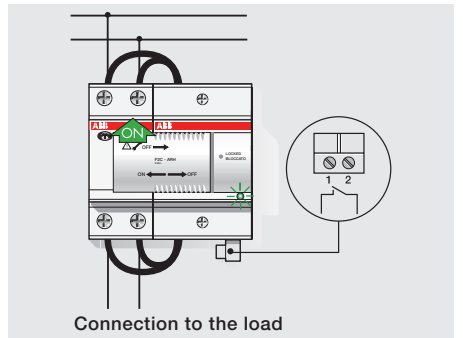

**Delay time (only on F2C-ARH-T)**

A simple programming system allows you to delay the time at which the test is performed in relation to the time when the autotest system was activated. A five, ten and fifteen hour delay can be obtained by releasing and pressing the programming key once, twice or three times when the red LED light has become fixed after having been pressed the first time.

**LED light**

The multicolored LED on the front of the Greenlight device informs the user at a glance when the system is in the normal condition: if the reclosing system is activated, if the system is being tested because the residual current circuit-breaker has tripped, if the device is in the blocked status owing to a permanent fault in the installation and, lastly, if the residual current circuit-breaker has not passed the automatic test (only F2C-ARH-T) and maintenance work by an electrician is required in order to inspect.

**Signalling contacts**

A signalling contact allows the device to signal faults by remote control. For example, in combination with a telephone actuator (ATT-22) it can transmit information to a mobile phone to warn the user that the residual current circuit-breaker has tripped and that Greenlight has failed its reclosing because it has detected a fault in the installation.

# Ordering Information

## F2C-ARH, F2C-ARH-T



F2C-ARH

2CSC400030D0202

Description	N° module [17.5 mm]	Bbn 8012542 EAN	Order details		Price	Weight 1 piece Kg
			Type code	Order code		
Auto-reclosing device for 30 mA 2P RCCBs	3	732433	F2C-ARH	2CSF200992R0005		0.200
Auto-reclosing device for 100 mA 2P RCCBs	3	658535	F2C-ARH100	2CSF200990R0005		0.200
Auto-reclosing device with automatic test for 30 mA 2P RCCBs	3	733232	F2C-ARH-T	2CSF200991R0005		0.200
Auto-reclosing device with automatic test for 100 mA 2P RCCBs	3	593836	F2C-ARH-T100	2CSF200989R0005		0.200

4

### F2C-ARH, F2C-ARH100

### F2C-ARH-T, F2C-ARH-T100

#### Technical details

	F2C-ARH, F2C-ARH100	F2C-ARH-T, F2C-ARH-T100
Power supply	230 V a.c. (-15% / +10%)	230 V a.c. (-15% / +10%)
Number of automatic reclosing attempts	1	1
Reset time for counter of automatic reclosing attempts	12 sec	12 sec
Power consumption during operation	(t<0.5s) 20VA max	(t<0.5s) 20VA max
Power consumption when idle	0.4W max	0.4W max
Number of operations	≤ 10,000	≤ 10,000
Operating temperature	-25 ... + 55 °C	-25 ... + 55 °C
Signalling contact cable section	≤ 2.5 mm <sup>2</sup>	≤ 2.5 mm <sup>2</sup>
Type of RCCB compatible	FH202-F202 30mA/100 mA (depending on version), up to 63A	FH202-F202 30mA/100 mA (depending on version), up to 63A
Locked state signalling contact (terminals 1-2)	1NO (change-over)	1NO (change-over)
Rated current of locked state contact	3A (250 V a.c.)	3A (250 V a.c.)
Autotest of the residual current circuit-breaker	NO	YES

# Ordering Information

## E 450 priority switches



E 451-5,7A

The priority switch is used in wiring systems where existing lead cross sections or the size of the power supply service box do not allow for simultaneous operation of two powerful loads (e.g. storage heating and flow-type heater).

The priority switch disconnects the long-term load (storage heating) for as long as the short-term consumer (flow-type heater) is switched on.

The coil of the priority switch is connected in series to the short-term load. When this load is switched on, the NC contact of the priority switch disconnects e.g. the heating system contactor.

Rated current range	Power loss W	N° module [17.5 mm]	Bbn 4016779 EAN	Order details		Price	Weight 1 piece Kg	Pack unit
				Type code	Order code			
6,7 ... 39 A	2.4	1	415903	E 451 - 5.7 A	2CDE160000R0901		0.1	10
6.7 ... 39 A	2.4	1	209502	E 452 - 5.7 A	2CDE160010R0901		0.1	10

	E 451-5.7	E 452-5.7
<b>Technical details</b>		
<b>Operating coil</b>		
Range of rated current	6.7 ... 39 A	
equivalent to	1.5 ... 9 kW at 230 V, 4.6 ... 27 kW at 230/400 V	
Threshold current	3.1 ... 5.3 A	
OFF delay (max.)	0 main half waves	2 main half waves
Max. continuous current	43 A	
Therm. continuous capacity at 40 °C/104 °F	5 W	
<b>Contact assembly</b>		
Control contact	1 NC contact	
Rated contact current at 250 V	1 A	
Contact material	solid silver	
Max. switching voltage	400 V	
Max. switching capacity	230 VA	
Max. switched current	1 A	
Max. inrush current peak	5 A	
Electr. service life	> 10 <sup>9</sup> operations	
Mechanical service life	ca. 2 x 10 <sup>6</sup> operations	
Max. electrical switching rate	ca. 1800 operations/hour	
ON duration	100 %	
Ambient temperature	- 20 °C/- 4 °F to + 40 °C/104 °F	
Response time	10 ... 20 ms	
Release time	5 ... 20 ms	≥ 20 ms
Test voltage contact/coil	2.5 kV	
Clearance and creepage distance	C/250 V AC cording to IEC 669-1-23	
Degree of protection	IP 40	
Protection against electric shock	according to DIN VDE 0106 Part 100 (BGV A2)	
Terminal contact	series coil up to 16 mm <sup>2</sup> , control contact up to 2.5 mm <sup>2</sup>	

# Ordering Information

## ATT GSM modules



2CSC40030R137

ATT-22

4

The ATT modules are GSM telephone actuators for remotely controlling electrical loads over the mobile phone network, which answer the installation requirements of a variety of application settings.

In particular, the ATT-22 version consists of a control module with 2 outputs and 2 inputs for residential, services-sector and industrial installations, while the ATT-81 alarm module, with 8 inputs and one output, is suitable for status and alarm monitoring in industrial and services-sector installations.

Instructions and alarms can be sent via SMS message, free phone call ring, fax or e-mail according to need. Configuration can be accomplished by SMS messages or using the ATT-Tool software.

All the ATT modules are supplied with backup lithium battery, ATT-Tool programming software and PC connecting cable. In addition, the ATT-22E and ATT-81E models are equipped with a pre-wired external antenna – essential if the module is installed in locations that do not assure adequate GSM coverage, such as cellars, enclosed metal structures, etc.

The modules can be supplied with an ABB type TS 25/12-24 C modular transformer and are compatible with the GSM SIM cards of all mobile telephone operators.

Inputs	Outputs	N° module [17.5 mm]	Bbn 8012542 EAN	Order details		Price	Weight 1 piece Kg	Pack unit
				Type code	Order code			
2 analog or digital	2 NO	4	944904	ATT-22	2CSM322000R1371		0.200	1
8 digital	1 NO	4	945000	ATT-81	2CSM381000R1371		0.200	1
2 analog or digital	2 NO	4	083450	ATT-22E	2CSM208345R1371		0.200	1
8 digital	1 NO	4	083559	ATT-81E	2CSM208355R1371		0.200	1

**ATT-22**

**Technical details**

GSM module			Dual band EGSM900 and GSM1800 for data, sms, fax and voice applications. Full Type Approved conforming to ETSI GSM Phase 2+
Output power			Class 4 (2 W@900 MHz ) Class 1 (1 W@1800 MHz )
Commands sent by			SMS, call rings, DTMF tones, GPRS connection
Incoming alarms			SMS, call rings, e-mail, fax
Inputs	digital		self-powered max. 20 V DC, 2 mA
	analog (only ATT-22)		input voltage 0..10 V input impedance < 10 Kohm / 100 nF sampling rate 90 Ksps
Outputs	relay		NO 4 A 250 V AC - max 2500 VA
	minimum load		100 mA, 12 V
GSM indicator LED	OFF		device not supplied
	STEADY ON		device under power not connected to mobile network, SIM pin code missing or incorrect
	SLOW BLINK		device under power, connected to mobile network
	FAST BLINK		communication in progress
Power supply		[V]	12 ±10% AC/DC
Power consumption	when transmitting	[W]	2.5
	in stand-by	[W]	0.4
Terminal section			2.5 mm <sup>2</sup>
Temperature	ambient	[°C]	-20..55
	storage	[°C]	-30..85
Relative humidity	ambient		5...95% non condensing
	storage		5...95% only external condensation
Modules			4
Protection degree			IP40

# Ordering Information

## RAL overload relays



RAL6

Installed downstream of the main circuit-breaker in a single-phase system, they constantly compare the actual power consumption to the preset threshold. An acoustic alarm alerts that some appliances must be switched off to avoid tripping the main circuit-breaker whenever the preset threshold is exceeded. The device calibration is 3 kW.

RAL built in relay output contact allows the following functions to be implemented:

a) remote signalling (acoustic or lighting)

b) opening a divisional circuit-breaker to disable a non essential electrical appliance.

Function b) allows one or more appliances to be automatically switched off in order to keep the power consumption within the preset limit and avoid unwanted tripping of the current-limiting device installed outside the home (e.g. in the basement). RAL must be reset manually.

Adjustable range	N° module	Bbn 8012542	Order details		Price	Weight 1 piece	Pack unit
			Type code	Order code			
kW	[17.5 mm]	EAN					
0/3	2	400509	RAL 3	2CSM111200R1301		0.200	6
0/6	2	400608	RAL 6	2CSM121200R1301		0.200	6

		RAL3	RAL6
<b>Technical details</b>			
Rated voltage $U_n$	[V]	AC 230	
Rated current $I_n$	[A]	18.3	27.5
Rated contact capacity $I_n$	[A]	12 $\cos\phi=1$ ; 4 $\cos\phi=0.8$	
Rated frequency	[Hz]	50	
Adjustment ranges	[A]	0...18.3	0...27.5
Power consumption	[W]	10	
Modules	[No.]	2	
Intervention delay		instantaneous	

# Ordering Information

## LSS1/2 load shedding switch



2CSC400030D020

LSS1/2

Installed downstream of the main circuit-breaker, it compares the actual power consumption of the system to a preset maximum permitted value, and prevents tripping of the main circuit-breaker by sequentially switching off a maximum of two non-priority loads (NPL1 and NPL2) when the preset threshold is exceeded. A green LED indicates the presence of the supply voltage, and two red LEDs indicate the load OFF conditions. At preset time intervals, the device automatically attempts to reconnect the previously disabled loads.

N° module	Bbn 8012542	Order details		Weight 1 piece	Pack unit
[17.5 mm]	EAN	Type code	Order code	Price	Kg
5	274407	LSS1/2	2CSM112500R1311		0.400

4

### LSS1/2

#### Technical details

Rated voltage $U_n$	[V]	a.c. 230
Rated capacity $I_n$	[A]	90
Rated contact capacity $I_n$ NPL1 and NPL2	[A]	16 each (terminals 12 and 14)
Rated frequency	[Hz]	50/60
Regulating thresholds	[A]	5...30 10...60 15...90
Load reinsertion delay		5-7 min. (NPL1); 4-5, 50 min. (NPL2)
Load disinsertion delay		about 2 sec.
Indicators		1 green LED = supply voltage available 2 red LEDs = loads switched off
Load OFF remote signalling	[A]	1 (terminals 11 and 13)
Terminals	Primary load	35 mm <sup>2</sup>
	Non priority loads	10 mm <sup>2</sup>
Power consumption	[W]	5
Modules	[No.]	5



# Ordering Information

## E 235 mains disconnection relays - Bioswitch



E 235-NFS



E 235-GLA

Constant exposure of electrical interference fields originating from live conductors - as is the case e.g. in bedrooms - may impair the well-being of people, experts say. With the extra base load adapter E235-GLA, the mains disconnection relays can be switched on manually.

For the permanent installation of loads that switch on independently of the supply voltage, such as fluorescent lamps, a E235-GLE PTC base load element is available.

Description	N° module [17.5 mm]	Bbn 4016779 EAN	Order details		Price	Weight 1 piece Kg
			Type code	Order code		
mains disconnection relay	1	571821	E 235-NFS	2CDE110000R1701		0.065
base load element	1	571814	E 235-GLE	2CDE100500R1711		0.001
base load adapter	1	571869	E 235-GLA	2CDE100510R1711		0.070

### E 235

#### Technical details

Short circuit rupturing capacity	16 A/230 V AC
Rated frequency	50/60 Hz
Range of control voltage	0.9 to 1.1 Un
Load of filament lamps	2300 W
Fluorescent lamp load:	
twin lamp circuit	100 W
shunt compensated	56 W
electronic ballast	max. 36 W, dependent on manufacturer
Induce load	6 A $\cos\phi = 0.6$
Max. switching capacity ( $\cos\phi 0.5$ )	3500 VA
Intrinsic consumption ca.	1 W
Control voltage	5 V AC
Adjustable making capacity	2 - 15 VA
Breaking capacity	0.66 x making capacity
ON delay	50 ms
OFF delay	ca. 3 sec.
Contact assembly	1 NO contact
Service life at rated load	> 100000 switching cycles
Ambient temperature	- 10 °C/14 °F to +45 °C/113 °F
Connection capacity (clamping terminal)	max 2.5 mm <sup>2</sup>

# Ordering Information

## Socket Outlets



2CSC400030F0132

M1175



2CSC400030F0133

M1173



2CSC400030F0134

M1174

N° module	Bbn 8012542	Order details			Weight 1 piece	Pack unit
[17.5 mm]	EAN	Type code	Order code	Price	Kg	
<b>German Shuko standard modular sockets</b>						
2.5	027850	M1175	2CSM210000R0721		0.120	4
<b>Italian P30 standard modular sockets</b>						
2.5	004103	M1173	2CSM110000R0701		0.120	4
<b>French standard modular sockets</b>						
2.5	006602	M1174	2CSM110000R0711		0.120	4

4

		M1175	M1174	M1173
<b>Technical details</b>				
Rated voltage $U_n$	[V]	250 AC		
Rated current $I_n$	[A]	16 (M1170, M1173, M1174, M1175),		
Rated frequency	[Hz]	50/60		
Power loss	[W]	0,6		
Modules	[No.]	2.5		
Safety shutters		yes, on entire range		
Terminal type		positive safety		
Cable section (ø min./max.)	[mm <sup>2</sup> ]	2.5 / 16		
Tightening torque	[Nm]	1.2		
Temperature	storage	[°C] -40 ... +70		
	operating	[°C] -25 ... +35		
Protection degree		IP20		
Reference standards		DIN VDE 0620-1	NF C 61 303	CEI 23-50
Approvals		VDE, GOST	LCIE, CEBEC, GOST	IMQ, GOST

# Ordering Information

## LEE 230 extractable power failure signalling lamp



LEE 230



The LEE 230 lamp is an automatic electronic lamp that can be installed in any modular socket or wiring accessory socket conforming to the German VDE Schuko standard (e.g. ABB M1173 or M1175), to the Italian standard P11 10A, or to the 10/16 A Italian dual standard. The device functions both as a power failure signalling lamp and as a lighting device, to be used for example during maintenance activities or when seeking faults in the panel.

Pack	N° module [17.5 mm]	Bbn 8012542 EAN	Order details		Price Kg	Weight 1 piece	Pack unit
			Type code	Order code			
Blister	-	507406	LEE 230	2CSM111000R1361		0.100	1

### LEE 230

#### Technical details

2P 10 A plug		distance between pins 19 mm, pin ø 4 mm
Supply	[V]	230 AC, 50-60 Hz
Recharge time	[h]	24
Endurance	[h]	3
Lighting level	[mcd]	3000
Operating temperature	[°C]	0...+45
Min. life cycle		5 years (battery)

#### Additional technical features

LEE-230 lamp automatically switches on when the voltage fails; the built-in rechargeable battery guarantees the supply. It is particularly useful thanks to its construction and functional characteristics:

- it can be extracted from the socket and used as a torch with ON-OFF button on its frontal side
- when necessary it can work with standard sockets
- it can be moved when it is needed
- it has a long operation endurance, up to three hours
- it is ready to use, it does not require installation
- with a screw (ø 3.5 mm, L 16 mm) it is possible to fix it preventing the extraction from the M1173 ABB sockets with central hole
- the projecting part of the Schuko profile is very small (8 mm).

The two LEDs placed on the frontal side of the lamp indicate its operation condition:

- the red LED indicates the recharge activity and that, in the case of a network voltage back-out, the lamp will remain off
- the green LED indicates the recharge activity and that, in the case of a network voltage black-out, the lamp will switch on (it will automatically switch off when the voltage returns).

By pushing the frontal pushbutton it is possible to change the status; if you do not use the lamp for a prolonged time it is suggested to set the first condition in order to preserve the battery life.

# Overall dimensions

## F2C-ARH, F2C-ARH-T

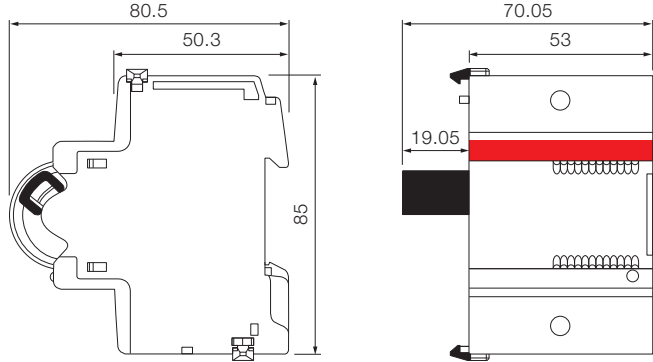

## ATT

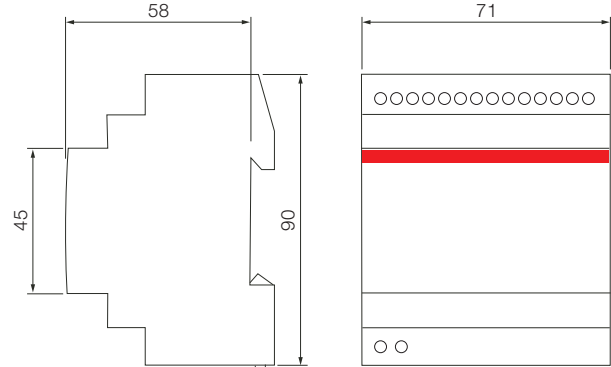

## E 450

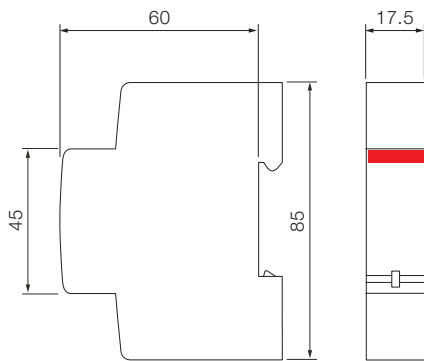

## RAL

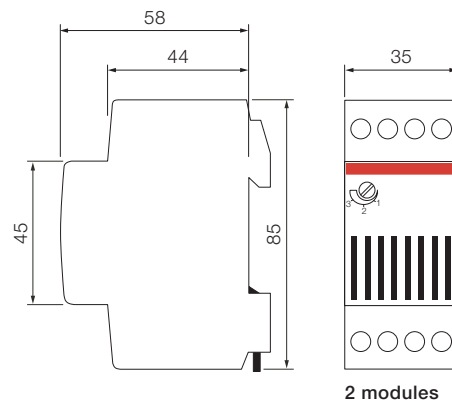

## LSS1/2

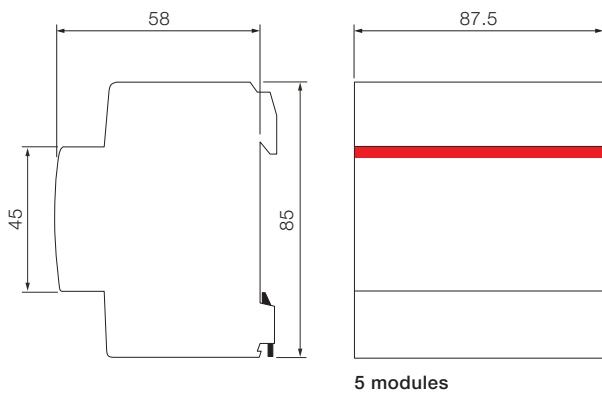

## E 235

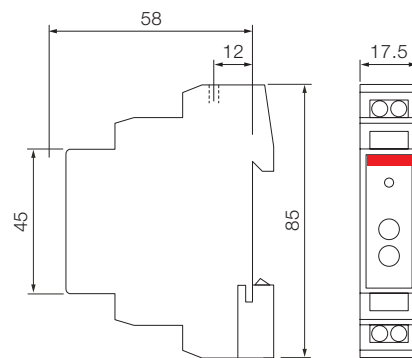

# Overall dimensions

## M1175, M1174, M1173 sockets

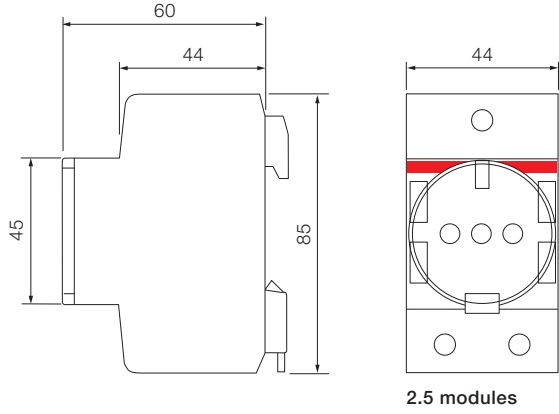

## LEE 230

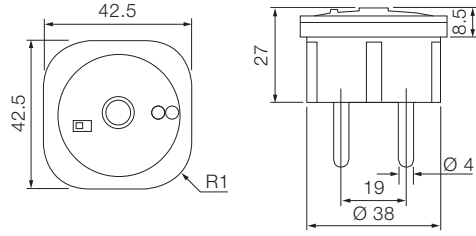

# Energy efficiency

Introduction	5/2
Plus of range	5/4
Technical features	5/6
<b>Ordering information</b>	
EQ meters C11	5/8
EQ meters A41	5/9
ODIN	5/10
EQ meters A43	5/11
Communication adapters	5/12
AT electro-mechanical time switches	5/14
D Line digital time switches	5/15
E 232 staircase lighting time-delay switches	5/16
TW modular twilight switches	5/18
TWP pole mounting twilight switch	5/19
TWA twilight astronomical switches	5/20
E 233 electro-mechanical hour counters	5/21
VLMD, AMTD digital instruments with alarm relay	5/22
Overall dimensions	5/23

## Energy savings, safety gains ABB for energy efficiency

ABB is a leading producer of low-voltage devices for commercial and residential building sector. Its complete offering that can help to achieve significant reduction of energy budget through an accurate monitoring and control of every parameter of the building: heating temperature, lighting, energy consumption of electric appliances can be adapted to actual needs, with a substantial saving potential without compromising comfort, safety or quality of life.

5





Commercial and residential buildings account for a big part of global end-user energy demand. ABB systems that can help to achieve savings through an accurate monitoring and control of electric loads such HVAC systems, lighting installations and appliances.

The modular DIN rail electricity meters of ABB's portfolio offer a wide range of programmable functions useful to measure electricity consumption and reduce energy costs. The line of DIN-mounted electricity meters and the wide range of communication adapters offer an ideal solution for every application.

Control loads operations in a system improves functionality and optimize power consumption. Programming the control of electric appliances according to the needs of each application obtains measurable advantages in terms of comfort and reduction of power wastage.

The range of ABB's modular analogue and digital time switches includes several functions that guarantee the opening and closing of electrical circuits according to a scheduled program. AT analogue time-switches are available in both daily and weekly versions, with 16 A contact which can be operated according to a timing program. Some versions are equipped with a built-in battery, generally charged by the network voltage, which enables them to maintain the timing function even in case of lengthy power supply failures.

DT digital time switches ABB are equipped with a permanent EEPROM memory to ensure that the scheduled timing is followed and the date and hour settings are maintained even in case of power down. The range, used for both daily and weekly programming, includes single/double channel versions with a change-over contact and a switching capacity of 16 or 10 A. Some time switches can be combined with DT-DCF antenna for automatic synchronization with Frankfurt official time. New features include a holiday mode that allows forcing

of the ON-OFF output for a certain period, a random mode used to simulate event presence, and a waiver mode to carry out waivers remotely or locally.

Rationalization of the light consumption is very important. To command the lighting in stairs of buildings, ABB offers the time-delay switch E 232. The switch includes an electro-mechanical timer with a synchronous motor drive to ensure high operational safety in whatever mounting position. The time range is adjustable in increments of 15 seconds from 1 to seven minutes. Devices include an integrated warning feature (warning by blinking) according to DIN 18015-2 as well as a 60 minute long-time function.

For lamps control, ABB's TW modular twilight switches allow to switch on and off lighting devices according to a scheduled level of ambient light. They are used in combination with a sensor to detect if the ambient light is higher or lower than the set level. TW2/10K, equipped with three different types of adjustment range (2:100, 2:1000, 2:10000), fits the daylight applications where Lux values are very high. This range addresses all applications, for example shop windows, parking areas and so on.

Hour counters – as E 233 series – offer a very important function for energy budget improvement. They are used to record operating times as well as to determine idle times and off times of electric loads in commercial or domestic installations, with an immediate feedback on energy consumption.

In terms of energy quality, modular digital instruments of VLMD and AMTD series measure voltage, current and frequency. The range is composed by a voltmeter for a.c./d.c. voltage monitoring, ammeter for a.c./d.c. currents, and frequency meter. Ammeters measure in indirect insertion thanks to measuring accessories, like current transformer for a.c. and shunt for d.c. The full scale is programmable by the user.



# Electricity meters

## The details make the difference

Infrared port for communication between communications adapter and meter

DIN rail mounted and pro M design

5

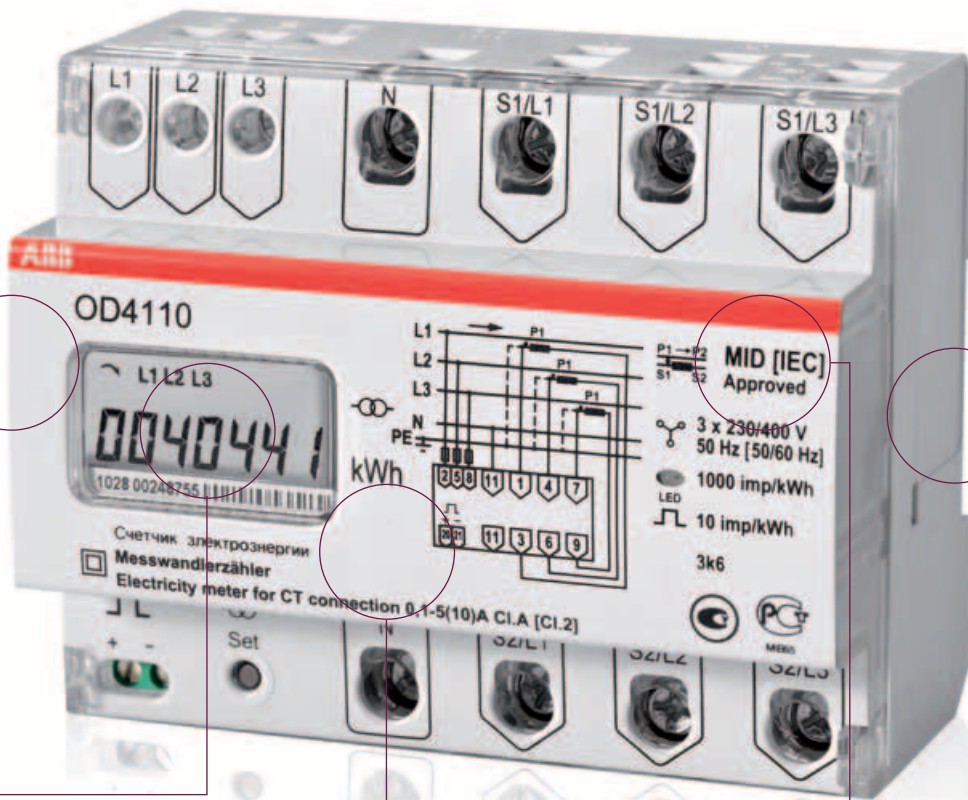

LCD display

MID approved  
“annex B and D”

Wide temperature range

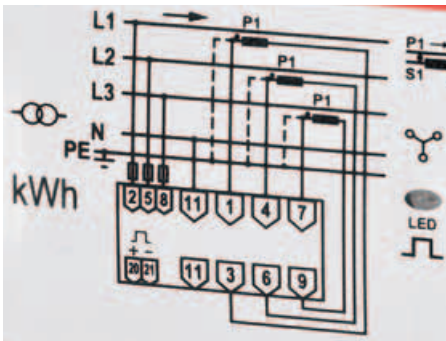

The DIN rail mounted electricity meters are available in two product families: ODINsingle and EQ meters C11 and A41 for single phase metering and EQ meters A43 three phase metering. The meters are available in several configurations to suite many applications.

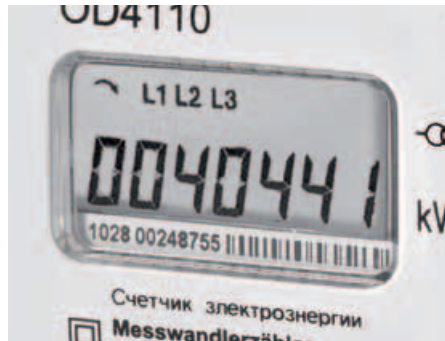

EQ meters A-series have a pixel-oriented display that shows the values clearly and is easy to navigate through the menu. Due to compact design of the meters, only 1 to 7 modules, space will be saved at installation. The meters have a temperature range from -40 °C to +70 °C (storage +85 °C).



The EQ meters A-series, ODINsingle and ODIN meters offer flexible solutions for communication with in-built communication, standard pulse output and/or infrared (IR) port. The IR port can be connected to any of the Serial Communication Adapters (SCA) available. Due to open protocols and the possibility to add a SCA later the installation is flexible and adaptable to any future communication needs. The Serial Communication Adapter (SCA) enables serial data communication between the electricity meter and an Automatic Meter Reading system (AMR).

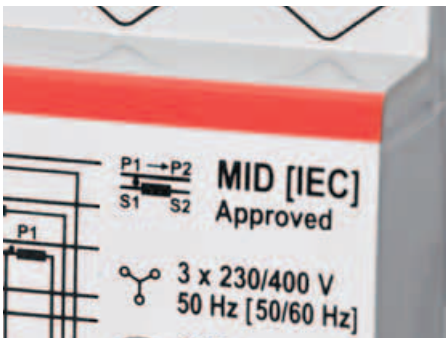

MID – Measuring Instrument Directive - means common testing rules based on IEC standards for all EU and EES countries. You find a label certifying that the ABB electricity meter is tested and approved according to MID directive.

# Technical features table for electricity meters EQ meters and ODIN



5

	C11	ODINsingle
<b>Technical Data</b>		
Single phase	Yes	Yes
Three phase 3 wire (TPE)	N/A	N/A
Three phase 4 wire (TPE+N)	N/A	N/A
Accuracy class MID [IEC]	B [1]	B [1]
Internal clock	N/A	N/A
Voltage	230 VAC	230 V
Frequency	50/60 Hz	50/60 Hz
Active energy	Yes	Yes
Reactive energy	N/A	N/A
Tariffs	1	1
Pulse output	Yes	Yes
Built-in communication	N/A	IR
Width, DIN modules	1	2
Direct connected	Yes	Yes
$I_{min}$	0,25 A	0,25 A
$I_{ref}$	5 A	5 A
$I_{max}$	40 A	65 A
$I_{st}$	< 20 mA	20 mA
Power consumption Current circuits	0,02 W	0,004 VA, 0,004 W
Power consumption voltage circuits	< 0,8 VA, 0,2 W	1,0 VA, 1,0 W
Transformer connected <sup>1)</sup>	N/A	N/A
$I_{min}$	N/A	N/A
$I_n$	N/A	N/A
$I_{max}$	N/A	N/A
$I_{st}$	N/A	N/A
Max transformer ratio	N/A	N/A
Power consumption Current circuits	N/A	N/A
Power consumption voltage circuits	N/A	N/A
Tariff control	N/A	N/A
Instrumentation values	Yes	N/A
I/O	N/A	N/A
Previous values	N/A	N/A
Max Demand	N/A	N/A
Load profiles	N/A	N/A
Harmonics	N/A	N/A

<sup>1)</sup> For ABB current/voltage transformers range, please see System pro M compact® catalogue 2CSC400002D0209



2CSC400030F0141



2CSC400030F0138



2CSC400030F0143

**A41**

**ODIN**

**A43**

Yes  
N/A  
N/A  
B [1]  
Yes  
57,7 - 288 VAC  
50/60 Hz  
Yes  
Yes  
4  
Yes  
IR, Modbus, M-bus  
4

N/A  
N/A  
Yes  
A [2]  
N/A  
230/400  
50/60 Hz  
Yes  
N/A  
1  
Yes  
IR  
6

Yes  
Yes  
Yes  
B [1]  
Yes  
3x57,7-288/100-500 VAC  
50/60 Hz  
Yes  
Yes  
4  
Yes  
IR, Modbus, M-bus  
7

Yes  
0,25 A  
5 A  
80 A  
< 20 mA  
0,007 VA, 0,007 W  
0,8 VA, 0,8 W

Yes  
0,25 A  
5 A  
65 A  
25 mA  
0,004 VA, 0,004 W per phase  
0,9 VA, 0,9 W per phase

Yes  
0,25 A  
5 A  
80 A  
< 20 mA  
0,007 VA, 0,007 W  
0,8 VA, 0,8 W

N/A  
N/A  
N/A  
N/A  
N/A  
N/A  
N/A  
N/A

CT  
0,1 A  
5 A  
10 A  
15 mA  
900/5  
0,004 VA, 0,004 W per phase  
0,9 VA, 0,9 W per phase

N/A  
N/A  
N/A  
N/A  
N/A  
N/A  
N/A  
N/A

I/O, internal clock, communication  
Yes  
2 fixed inputs, 2 fixed outputs  
Day, week, month  
1, ..., 1440 min interval  
1, ..., 1440 min interval  
N/A

N/A  
N/A  
N/A  
N/A  
N/A  
N/A  
N/A

I/O, internal clock, communication  
Yes  
2 fixed inputs, 2 fixed outputs  
Day, week, month  
1, ..., 1440 min interval  
1, ..., 1440 min interval  
N/A



# Ordering Information

## EQ meters C11



C11

The C11 is a very compact single phase meter for direct connected applications up to 40 A. The small size and the DIN rail mounting makes it suitable for installation in distribution boards and small standard enclosures. The power consumption of the meter is very low, less than 0.8 VA (0.2 W).

Main characteristics include:

- Single phase metering
- Active energy, accuracy class B (Cl. 1)
- Direct metering up to 40 A
- LCD display
- Pulse output or alarm
- IEC and MID type approval

EQ meters C11 has an LCD with large digits on a vertical line and small digits on a horizontal line below. Due to the compact design of the meter, only 1 module, space will be saved at installation. The meter has a wide temperature range which makes it possible to install the meter in many locations, - 25°C - +70°C (storage - 25°C - +80°C).

Navigating the meter is easily done via the push-button below the display. The C11 meters support reading of instrument values. A number of electrical properties can be read:

- Power factor
- Active power
- Current
- Voltage

C11 has one output that could be used as pulse output or as an alarm output.

The C11 is tested and approved according to different standards. These standards cover technical aspects of the meter such as climate conditions, electromagnetic compatibility (EMC), electrical requirements, mechanical requirements and accuracy.

N° module	Bbn	Order details		Price	Weight	Pack unit
	7392696	Type code	Order code		1 piece	
[17.5 mm]	EAN				Kg	
1	705509	C11 110-300	2CMA170550R1000		0.070	1

# Ordering Information

## EQ meters A41



A41

EQ meters A41 is an advanced single phase electricity meter for active energy. It is designed for installation on a DIN rail in distribution boards and small enclosures. Key product features are internal clock for tariff handling and direct metering up to 80 A.

Main specifications are:

- Single phase measuring
- Active energy, accuracy class B (Cl. 1)
- Measure import/export energy
- Direct metering up to 80A
- Pixel-oriented display
- In-built M-bus or Modbus, pulse output and IR for SCA
- Internal clock for up to 4 tariffs and monthly values
- Memory back-up (EEPROM)
- IEC and MID approval

This active energy, single phase meter for direct metering up to 80 A is equipped with a pixel-oriented display which allows for showing values clearly together with instrumentation values and a easy navigated menu system. The meter has a compact design, only 4 modules (72 mm) that saves space in the installation. In the case of a power failure, the meter is equipped with a "Super Cap" power backup capacitor that will run the clock for 48 hours at +20° C. A red LED (Light Emitting Diode) on the front flashes proportionally to the energy consumed. The operating temperature range is from -40 to +70° C (storage +80° C).

EQ meters A41 has 4 ways to communicate depending on type

- In-built M-bus or Modbus (RS485)
- IR interface for serial communication (together with the serial communication adapter)
- Pulse output
- Front display

It is possible to choose information shown on the display and change the settings in the meter using the push buttons. The push button used for changing settings can be sealed. The EQ meters A41 includes up to 4 tariffs options which can be changed by inputs, communication or internal clock. All EQ meters A41 are tested and approved according to different standards. These standards covers all technical aspects of the meter such as climate conditions, electromagnetic compatibility (EMC), electrical requirements, mechanical requirements as well as accuracy.

N° module	Bbn 7392696	Order details		Price	Weight Kg	Pack unit
		Type code	Order code			
[17.5 mm]	EAN					
4	705059	A41 412-100	2CMA170505R1000		0.230	1
4	705066	A41 413-100	2CMA170506R1000		0.230	1

# Ordering Information

## ODIN and ODINsingle



2CSC400030F0142

OD4165

Basic 3-phase ODIN Meter is an electricity meter in a compact format designed to measure active energy and for mounting on a DIN rail. It is suitable for use in distribution boards and standard cabinets.

ODIN meter is an active energy, 3-phase meter for up to 65A or transformer connected up to 10 A secondary.

The LCD display (Liquid Crystal Display) has 7 digits, 6 mm high and reports information such as phase, load or transformer ratio.

The compact design, only 6 modules, saves space in the installation.

Selection of the transformer ratio is easily achieved by using the push button on the front.

The programming / push button can be sealed.

N° module	Bbn 7392696	Order details			Weight 1 piece	Pack unit
[17.5 mm]	EAN	Type code	Order code	Price	Kg	
6	310246	OD4165	2CMA131024R1000		0.420	1
6	310253	OD4110	2CMA131025R1000		0.450	1



2CSC400030F0136

OD1065

ODINsingle is a compact, single phase electricity meter for direct connection up to 65 A. The small size and the DIN rail mounting makes it suitable for installation in distribution boards and small standard enclosures.

Main characteristics include:

- Single phase measuring
- Active energy, accuracy class B (Cl. 1)
- Direct metering up to 65A
- LCD display, Pulse output and IR for SCA
- IEC and MID approval

N° module	Bbn 7392696	Order details			Weight 1 piece	Pack unit
[17.5 mm]	EAN	Type code	Order code	Price	Kg	
2	310406	OD1065	2CMA131040R1000		0.100	1
2	310413	OD1310	2CMA131041R1000		0.100	1

ODIN and ODINsingle has three ways to communicate:

- Front backlit LCD display
- IR interface for serial communication (together with a Serial Communication Adapter)
- Pulse output.

The ODIN and ODINsingle types are tested and approved according to different standards. These

standards cover technical aspects of the meter such as climate conditions, electromagnetic compatibility (EMC), electrical requirements, mechanical requirements and accuracy.



# Ordering Information

## EQ meters A43



ZCSC400030D0202

A43

The EQ meters A43 is an advanced four quadrant meter for installation in three phase networks. The meter is mounted on a DIN rail and is suitable for installation in distribution boards and small enclosures such as consumer units. The meter measures (active and reactive) energy. The product supports a wide voltage range and a wide temperature range which makes it suitable for installation in many applications.

EQ meters A43 has a in-built clock function for controlling tariffs, save monthly values, and demand functionality. It is also used to log events with a time stamp for easy learn what have happend and when. All values can easily be read on the large pixel-oriented display together with the eady navigated menu system. The meter has a LED on the front that flashes proportionally to the measured energy. The energy consumption of the meter is very low, only 0.8 VA.

Data from EQ meters A43 is collected via pulse output or serial communication. The pulse output is a polarity independent solid state relay that generates pulses proportionally to the measured energy. EQ meters A43 can be equipped with a built-in communication interface for M-bus or Modbus (RS485). All EQ meters A43 come with an infrared port for communication with an external Serial Communication Adapter (SCA). There are SCAs for M-Bus, RS-232, Ethernet and GSM/GPRS.

The EQ meters A43 can handle up to 4 tariffs which could be controlled via internal clock, via communication or through inputs.

Through the instrumentation functionality of EQ meters A43 can be read electrical properties such as active power, apparent power, reactive power, current, voltage, frequency, power factor, active quadrant, and much more.

EQ meters A43 supports four fixed I/O's, two inputs and two outputs. Outputs can be used for controlling external apparatus like a contactor or an alarm (max 100 mA). Inputs can be used for counting pulses from e.g. a water meter, or for reading status from external devices.

The configuration of EQ meters A43 is very simple. Using the push bottoms you can configure transformer ratio, pulse frequency, M-Bus address and baud rate when applicable.

The settings button is under a sealable cover. When sealed, meter values can still be read but no configuration is possible. EQ meters is type approved according to IEC and it is both type approved and verified according to MID. MID is the Measuring Instruments Directive 2004/22/EC from the European Commission. MID type approval and verification is mandatory for meters in billing applications within EU and EEA.

The type approval is according to standards that covers all relevant technical aspects of the meter. These include climate conditions, electromagnetic compatibility (EMC), electrical requirements, mechanical requirements and accuracy.

N° module	Bbn 7392696	Order details			Weight 1 piece	Pack unit
[17.5 mm]	EAN	Type code	Order code	Price	Kg	
7	705288	A43 412-100	2CMA17528R1000		0.440	1
7	705295	A43 413-100	2CMA170529R100		0.440	1

# Ordering Information

## Communication adapters



CMM05000

2CSC400030FD144

5

The Serial Communication Adapter (SCA) enables serial data communication between the electricity meter and an Automatic Meter Reading system (AMR). These compact size, 2 DIN-modules complements ABB DIN-rail mounted electricity meters, which have an optical interface for remote reading of measured data and identity, using the M-Bus protocol. A SCA converts the optical signals to different chosen media (Twisted pair, etc.) and protocols (MODBUS, M-Bus, TCP/IP, etc.). The SCA is designed for DIN-rail mounting. The optical interface on the left side of ABB meter must face the optical interface on the right side of the SCA. It is important that the electricity meter and the adapter are installed close to each other. They are available in different versions. The SCA Two-wire M-bus can be ordered for two-wire an-Bus usage. To connect the M-Bus loop, terminals 1-2 or 3-4 can be used. The loop continues on the other two free terminals. The M-Bus two-wire connection is polarity insensitive. The two-wire connection is mainly used when several M-Bus slaves are to be connected into an M-Bus loop. The Adapter is powered directly by the M-Bus and does not require an additional power source. The M-Bus adapter consumes 3 mA i.e. two standard M-Bus loads. The RS232 M-Bus connection is used when connecting an M-Bus slave directly to a Master (e.g. PC/modem). The SCA Ethernet M-bus adapter is used for communication over Ethernet networks. It has two main functions. One is supporting remote reading using M-Bus over UDP or TCP. It is used by AMR systems. The other function is a built in web server. The Ethernet adapter is powered by 100 – 240 VAC (-20/+15%) between terminal 1 and 4. To connect to an Ethernet network a RJ-45 connector is used. The SCA GSM/GPRS M-bus communication adapter is a quad band GSM/GPRS device, which enables AMR with GSM or GPRS over GSM 850/900 and GSM 1800/2900 networks. Furthermore the ABB GSM/GPRS communication adapter support remote configuration using Short Message Service (SMS). The adapter is powered with 100-240 VAC (-15/+10%).

Voltage	IR port output	N° module	Bbn 7392696	Order details		Price	Weight 1 piece	Pack unit
V		[17.5 mm]	EAN	Type code	Order code		Kg	
100-240	Yes	2	371216	CEM 05100	2CMA137121R1000		-	1
100-240	Yes	2	371049	CGM 05000	2CMA137104R1000		0.105	1
100-240	Yes	2	371209	CMM 05000	2CMA137120R1000		0.070	1
-	Yes	2	370912	CRM 04000	2CMA137091R1000		0.072	1
100-240	-	2	371247	CSO 05000	2CMA137124R1000		0.102	1
-	Yes	2	370905	CTM 04000	2CMA137090R1000		0.073	1
-	Yes	2	-	ZS/S 1.1	2CDG110083R0011		0.067	1

## Technical details

Media	Protocol	Voltage	Connection	Additional function	SCA
Ethernet, IR	M-Bus	100-240 V	RJ-45	Web server	CEM 05100
GSM/GPRS, IR	M-Bus	100-240 V	SMA	Short Message Service (SMS)	CGM 05000
IR, IR, M-Bus TP	M-Bus	100-240 V	Bus connection terminal	M-Bus Master extension for 32 slaves	CMM 05000
RS-232, IR	M-Bus	Powered from RS-232	Screw terminal	N/A	CRM 04000
M-Bus TP, IR	M-Bus	Powered from bus	Screw terminal	N/A	CTM 04000
KNX bus, IR	KNX	Powered from bus	Bus connection terminal	N/A	ZS/S 1.1
MODBUS	-	-	-	-	CSO 05000

## Communication network

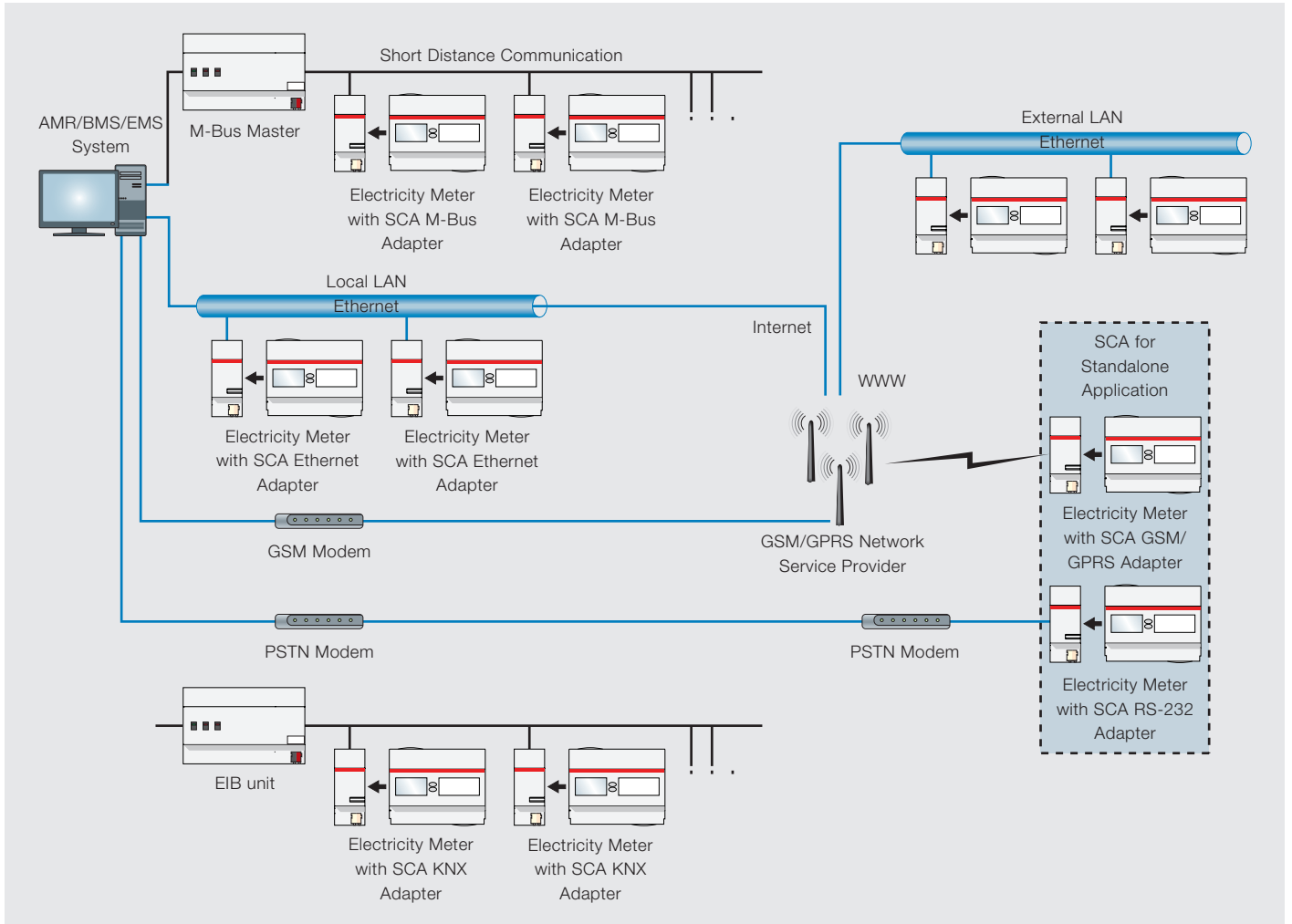

### Abbreviations:

- AMR** Automatic Meter Reading
- BMS** Building Management System
- EMS** Energy Management System
- GPRS** General Packet Radio System
- GSM** Global System for Mobile Communication
- LAN** Local Area Network
- PSTN** Public Switched Telephone Network
- SCA** Serial Communication Adapter

# Ordering Information

## AT electro-mechanical time switches



AT1



AT3

They control circuit opening and closing according to the scheduled program. Available both on daily and weekly version and equipped with a 16A contact, they can be set on the scheduled program or on the permanent ON function (ON-OFF only for three modules versions). The AT1-R, AT3-R and AT3-7R versions are equipped with a built-in battery, generally charged by the network voltage, which allows the devices to maintain the set time also in case of long (up to 200h) power supply failures. The products fit applications such as lighting systems, heating, irrigation systems and so forth.

Running reserve	Version	N° module [17.5 mm]	Bbn 8012542 EAN	Order details		Price	Weight 1 piece Kg	Pack unit
				Type code	Order code			
<b>Contact 1N0</b>								
200h	daily	1	042150	AT1-R	2CSM204215R0601		0.095	1
<b>Contact 1C0</b>								
200h	daily	3	042358	AT3-R	2CSM204235R0601		0.180	1
200h	weekly	3	042457	AT3-7R	2CSM204245R0601		0.180	1

				AT1-R	AT3-R	AT3-7R
<b>Technical details</b>						
Rated supply voltage		[V]		230 AC + 10%		
Contact type				1N0	1C0	1C0
Switching capacity	resistive load	[A]		16		
	inductive load	[A]		4	3	3
Rated frequency		[Hz]		50-60		
Time base				quartz		
Minimum switching time		[min]		15	15	120
Max number of commands per cycle				96	96	84
Running reserve		[h]		200	200	200
Accuracy				± 1sec / 24h		
Power consumption		[VA]		0.5		
Max. switching power		[W]		4000		
Terminal size for cable		[mm <sup>2</sup> ]		4		
Terminals				loss-proof screw		
Mounting				on DIN rail		
Operating temperature		[°C]		-10...+55		
Storage temperature		[°C]		-10...+55	-10...+55	-10...+55
Modules				1	3	3
Reference standards				EN 60730-1; EN 60730-2-7		

# Ordering Information

## D Line digital time switches



D1



D2

The unique design, with white backlit LCD display, and extreme ease of use with two lines of text menu and only four buttons, make D LINE ideal to automate the installation functions. Thanks to the innovative management of time vacation, the D Line digital time switches allow the exclusion of the normal weekly program in one or more periods of several years or between two different years.

The range includes 1 and 2 channel versions, equipped with large capacity internal battery to maintain operation without power supply and permanent memory EEPROM, to avoid the risk of program loss and to maintain the date and time settings in the event of power failure, irrespective of its duration.

The D Line is particularly useful in environments and situations where user management is required with a time schedule flexible enough to predict or exclude activities according to time and day of week or month.

Channels no.	N° module [17.5 mm]	Bbn 8012542 EAN	Order details		Price	Weight 1 piece Kg	Pack unit
			Type code	Order code			
1	2	587637	D1	2CSM258763R0621		0.140	1
2	2	563136	D2	2CSM256313R0621		0.140	1

5

		D1	D2
<b>Technical details</b>			
Rated voltage	[V]	230 AC ± 10%	
Rated pulsating voltage	[kV]	4	
Contact type		Contact relay in free exchange from potential	
250 V contact capacity			
Ohm loads	[A]	16	16
Inductive loads	[A]	10	2
Rated frequency	[Hz]	50-60	
Time base		quartz	
Minimum switching	[sec.]	1	
Max programs per cycle	[No.]	64 (can be coupled in day blocks)	
Load reserve	[years]	6 from the first start-up (lithium battery)	
External input	[No.]	1	2
Activity suspension		From 1 day to 12 months	
Operating precision	sec./ day	± 0.5	
Max. dissipated power	[VA]	6.5	7.8
Max. switch power	[VA]	3500	
Incandescent LP power	[W]	3000	
Non-rephased fluorescent tube LP power	[W]	1100	
Fluorescent tube LP power rephased in parallel	[W]	900	
Fluorescent tube LP power with electronic reactor	[W]	7 ÷ 23 (max. 23 lamp.)	
Fluorescent tube LP power rephased in series	[W]	1100	
Protection grade	[IP]	20	
Max. terminal section	[mm²]	6	
Terminals		In positive safety with captive screw	
Installation type		DIN rail	
Operating temperature	[°C]	-5 ... +55	
Storage temperature	[°C]	-10 ... +65	
Modules	[No.]	2	

# Ordering Information

## E 232 staircase lighting time-delay switches



E232-230



E232E-8/230N



E232-HLM

Staircase lighting time-delay switches are usually operated by pushbuttons, often fitted with a glow lamp. Switches are designed for a glow lamp current of up to 150 mA and thus perfectly suitable for installations in multi-storey buildings.

The E 232-230 staircase lighting time-delay switch includes an electro-mechanical timer with a synchronous motor drive to ensure high operational safety in whatever mounting position. The time range is adjustable in increments of 15 seconds from 1 to seven minutes. Resettable after 30 seconds.

E 232E-230N and E 232E-8/230N devices feature electronic time delays. A high switching capacity, 150 mA glow lamp current parallel to the pushbuttons, steplessly adjustable time range from 0.5 to 20 min, as well as low switching noise make these devices so special.

Devices of the E 232E-230 Multi 10 and E 232E-8/230 Multi 10 series are multi-functional products with 10 functions to choose from that can be adjusted from the front. Through an electronically controlled connection of the load at voltage zero, a very high switching capacity of 3,600 W (load of filament lamp) is reached.

The devices include an integrated warning feature (warning by blinking) according to DIN 18015-2 as well as a 60 minute long-time function.

The E 232E-8/230N and E 232E-8/230 Multi 10 staircase lighting time-delay switches offer an additional metallically separated control input for 8...240 V AC/DC.

The electronic E 232-HLM half-light module is a supplementary device for staircase lighting time-delay switches for semi-light control according to DIN 18015-2. The module switches filament lamps and 230 V halogen lamps up to 2,300 W in the warning phase to an output voltage that is reduced by 50%. Adjustable time range from 20 – 60 seconds.

Time range	Power loss	N° module	Bbn 4016779	Order details		Price	Weight 1 piece	Pack unit
				EAN	Type code			
1...7 min.	1 V A	1	548243	E232 230	2CDE110000R0501		0.081	10
20...60 sec.	6 V A	1	548281	E232-HLM	2CDE150000R0521		0.075	10
20 min	6 V A	1	654166	E232 E-230N	2CDE110003R0511		0.095	10
20 min	6 V A	1	654173	E232 E-8/230N	2CDE010003R0511		0.100	10
20 min	6 V A	1	654180	E232 E-230 Multi 10	2CDE110013R0511		0.100	10
20 min	6 V A	1	654197	E232 E-8/230 Multi 10	2CDE010013R0511		0.095	10

	E 232-230	E 232E-230N	E 232E-8/230N	E 232E-230 Multi 10	E 232E-8/230 Multi 10	E 232E-HLM
<b>Technical details</b>						
Time range (stepless)	1 – 7 min. in 15 sec. increments	0.5 – 20 min. stepless				20 – 60 sec. stepless
Control voltage 230 V AC	■	■	■	■	■	
Universal voltage in addition	-	-	8 ... 240 V AC/DC	-	8 ... 240 V AC/DC	-
Glow lamp load	50 mA	150 mA				-
3/4 conductor operated	switches	automatically				-
Resettable	■	■	■	■	■	
Steady-light switch	■	■	■	■	■	
Advance warning acc. DIN 18015-2				■	■	■
Long-time range of 60 min.				■	■	
Multi-functional device (10 functions)				■	■	
Rated voltage	230 V AC	230 ... 240 V AC				
	50Hz	50 / 60 Hz				
Control voltage range	0.9 ... 1.1 Un	0.85 ... 1.1 Un				0.9 ... 1.1 Un
Power loss	1 VA	6 VA				
Rated switching capacity	16 A, 230 V AC					10 A, 230 V AC
Filament lamp load	2,300 W			3,600 W		2,300 W
Halogen lamp load	2,300 W			3,600 W		2,300 W
Fluorescent lamps series compensated / uncorrected	2,300 VA			3,600 VA *		not permitted
Fluorescent lamps inductive or capacitive	2,300 VA			3,600 VA *		not permitted
Fluorescent lamps shunt compensated	1,300 VA (70 µF)	400 VA (42 µF)		1,200 VA (120 µF) *		not permitted
Electronic controlgear	9x7 W, 6x11 W	9x7 W, 7x11 W		34x7 W, 27x11 W		not permitted
	5x15 W, 5x20 W	7x20 W, 7x23 W		24x15 W, 22x23 W		-
Inductive load (cos φ = 0.6/230 V AC)	2,300					not permitted
Contact material	AgSnO2					
Contact gap	≥ 3 mm	< 3 mm				≥ 3 mm
Mech. serviceable life	> 10 <sup>6</sup>	> 10 <sup>7</sup>				
Serviceable life at rated load, cos φ =1	> 10 <sup>5</sup>	> 2x10 <sup>5</sup>				> 10 <sup>5</sup>
Serviceable life at rated load, cos φ =0.6	> 10 <sup>4</sup>	> 4x10 <sup>4</sup>				> 10 <sup>4</sup>
Terminal capacity	10.7 mm <sup>2</sup>	13 mm <sup>2</sup>				13.6 mm <sup>2</sup>
Max. conductor capacity	6 mm <sup>2</sup>	4 mm <sup>2</sup>				6 mm <sup>2</sup>
ON duration	Resettable after 30 sec.	100 %				
Ambient temperature	- 10 °C to + 50 °C	- 25 °C to + 50 °C				- 10 °C to + 50 °C
Housing and insulation material	heat resistant, self-extinguishing thermoplast					
Control current at 230 V AC	4.5 mA	26 mA		26 mA (min. 8 mA at 8 V AC)		-
Minimum command duration	10 ms	20 ms		20 ms / 50 ms for multi voltage input		-

\* no disconnection advance warning possible for this application.



# Ordering Information

## TW modular twilight switches



TW1



TW2/10K

They allow to switch on and switch off lighting devices according to a scheduled level of the ambient light. They are used in combination with a sensor to detect if the ambient light is higher or lower than the set level. TW2/10K, equipped with three different types of adjustment range (2:100, 2:1000, 2:10000), fits well the daylight applications where the Lux value is very high. This range, thanks to its features, fits all applications where the rationalization of the energy consumption is required.

Brightness range	N° module	Bbn 8012542	Order details		Weight 1 piece	Pack unit
lx	[17.5 mm]	EAN	Type code	Order code	Price Kg	
2 : 100	1	041351	TW1	2CSM204135R1341		0.107 1
2 : 10.000	2	041450	TW2/10K	2CSM204145R1341		0.215 1

			TW1	TW2/10K
<b>Technical details</b>				
Rated supply voltage		[V]	230 AC	
Contact type			1NO	1CO
Switching capacity	resistive load	[A]	16	
	inductive load cosφ 0.6	[A]	3	
	incandescent lamps	cosφ 1	max 960 W	max 1080 W
	fluorescent lamps	cosφ 0.8	max 720 W	max 720 W
	fluorescent - duo./electronic lamps	cosφ 0.9	max 200 W	max 200 W
Rated frequency		[Hz]	50-60	
Programs ON-OFF			-	-
Switching delay	ON	[s]	8 ±10%	8 ±10%
	OFF	[s]	38 ±10%	38 ±10%
Brightness range		[lx]		2:100
			2:100	2:1,000
				2:10,000
Accuracy			-	-
Protection degree	twilight switch		IP20	IP20
	sensor		IP65	IP65
Operating temperature	twilight switch	[°C]	0...+55	0...+55
	sensor	[°C]	-30...+65	-30...+65
Storage temperature	twilight switch		-10...+65	-10...+65
	sensor		-40...+75	-40...+75
Power consumption			4.5	2.5
Max. commutable power			3500	
Terminal size for cable			2.5	
Terminals			loss-proof screw	
Mounting			on DIN rail	
Switching status indication/brightness range			red Led / green Led	
Max wiring length			100	
Modules			1	2
Reference standards			EN 60669-1; EN 60669-2-1	

# Ordering Information

## TWP pole mounting twilight switch



TWP

The TWP pole twilight switch, equipped internally with a preset sensor of 10 Lux, is the ideal solution for the management of external light systems such as the public ones. The sensor is extractable from the base and allows an easy and efficient maintenance without needing further wiring.

Brightness range	N° module	Bbn 8012542	Order details		Weight 1 piece	Pack unit
lx	[17.5 mm]	EAN	Type code	Order code	Price Kg	
2 : 200	-	041658	TWP	2CSM204165R1341		1

### TWP

#### Technical details

Rated supply voltage		[V]	230 AC
Contact type			1NO polarized
Switching capacity	resistive load	[A]	16
	inductive load cos $\phi$ 0.6	[A]	3
	incandescent lamps	cos $\phi$ 1	max 960 W
	fluorescent lamps	cos $\phi$ 0.8	max 720 W
	fluorescent - duo./electronic lamps	cos $\phi$ 0.9	max 200 W
Rated frequency		[Hz]	50-60
Switching delay	ON	[s]	25 $\pm$ 10%
	OFF	[s]	25 $\pm$ 10%
Brightness range		[lx]	2-200
Protection degree		IP65	
Operating temperature		[°C]	-30...+60
Storage temperature		[°C]	-30...+65
Power consumption		[VA]	7.5
Max. commutable power		[W]	3500
Terminal size for cable		[mm <sup>2</sup> ]	2.5
Terminals		screw	
Mounting		pole	
Switching status indication/ brightness range			- / red Led
Reference standards			EN 60669-1; EN 60669-2-1

# Ordering Information

## TWA twilight astronomical switches



TWA-1

They allow to control automatically the light systems according to the hour when the sun rises and sets. The programming is made defining the longitude and latitude parameters of the geographical area where the switch is mounted. Thanks to its features the TWA fits applications, particularly when the external sensor is subjected to strong external inconveniences like in area with high level of pollution or in area exposed to vandalic acts.

Contacts	N° module	Bbn 8012542	Order details		Price	Weight 1 piece Kg	Pack unit
			Type code	Order code			
1 CO	[17.5 mm]	EAN 043652	TWA-1	2CSM204365R1341		0.160	1

5

### TWA-1

#### Technical details

Rated supply voltage		[V]	230 AC ± 15%
Contact type			1CO
Switching capacity	resistive load	[A]	16
	inductive load cosφ 0.6	[A]	10
Max. number of lamps	incandescent and halogen fluorescent	[W]	2300
	compensated (max. 45μF)	[W]	400
	non-compensated, series compensated	[W]	1000
	compact fluorescent	[W]	500
Rated frequency		[Hz]	50-60
Time base			quartz
Minimum time between two steps		[min]	1
Program steps			56
Power reserve		[years]	5
Accuracy			± 1,5sec / 24h
Astronomical time accuracy		[min]	± 10
Power consumption		[VA]	6
Terminal size for cable	flexible	[mm²]	1 to 6
	rigid	[mm²]	1.5 to 10
Terminals			loss-proof screw
Mounting			on DIN rail
Operating temperature		[°C]	-10...+55
Storage temperature		[°C]	-20...+60
Protection degree			IP20
Modules			2
Reference standards			NFC 15 100; IEC 60 634-1

# Ordering Information

## E 233 electro-mechanical hour counters



E233-230

Hour counters are used to record operating times as well as to determine idle times and off times of electrical loads in domestic installations.  
No reset functionality.

Rated voltage	N° module [17.5 mm]	Bbn 4012233 EAN	Order details		Price	Weight 1 piece Kg	Pack unit
			Type code	Order code			
AC 230 V/50 Hz	1	630004	E233-230	2CDE100000R1601		0.050	10

Technical details	AC equipment	DC equipment
	Rated voltage	50 Hz: 24 V, 230 V 60 Hz: 24 V, 120 V, 240 V*
Voltage tolerance	±15 %	±10 %
Power consumption	1.5 VA	ca. 20 mW (at 12 V DC)
Ambient temperature	-15 °C/5 °F... +50 °C/122 °F	-10 °C/14 °F ... +50 °C/122 °F
Counting capacity	99.999 h	99.999 h
Precision class	0.01 h	0.1 h
Operation display	fast running	LED blinking
Protection against electric shock	according to DIN VDE 0106 Part 100 (BGV A2)	according to DIN VDE 0106 Part 100 (BGV A2)
Terminal size	up to 10 mm <sup>2</sup>	up to 10 mm <sup>2</sup>

\* UL approval

# Ordering Information

## VLMD, AMTD digital instruments with alarm relay



VLMD-1-2



AMTD-1

The range comprises one voltmeter and one ammeter that display and monitor a value, tripping a relay contact and signalling the alarm condition if it over- or undershoots a programmable threshold. The alarm threshold as either a minimum or a maximum limit, the peak maximum and minimum values measured are stored in the non volatile instrument memory.

The contact type is NO, so that the contact is open when the instrument is powered off, but it is possible to obtain positive safety operation via a software setting which determines whether the alarm condition is with an open or closed contact.

The instrument with relay can be used as either a minum or maximum relay, but not for both functions simultaneously

Version	N° module [17.5 mm]	Bbn 8012542 EAN	Order details		Price	Weight 1 piece Kg	Pack unit
			Type code	Order code			
AC/DC digital voltmeter with alarm relay	3	746935	VLMD-1-2-R	2CSM274693R1011		0.300	1
AC digital ammeter with alarm relay	3	747734	AMTD-1-R	2CSM274773R1011		0.300	1

### VLMD, AMTD

#### Technical details

Power supply	[V]	230 V AC
Rated frequency	[Hz]	50÷60
Ammeter full scale value	[A]	5, 20, 25, 40, 60, 100, 150, 200, 250, 400, 600
Voltmeter full scale value	[V]	300, 500
Frequency meter range	[Hz]	35...400
Tripping delay	[s]	1, 5, 10, 20, 30
Hysteresis	[%]	5, 10, 20, 30 set threshold
Output pins		3-4
Output relay		NO
Rated voltage relay	[V]	230 V AC
Rated current relay	[A]	AC1 16, AC15 3
Relay configuration		NO relay closes in alarm status NC relay opens in alarm status, positive safety
Overload	[In/Vn]	1, 2
Accuracy class	[%]	±0,5 full scale ±1digit at 25 °C
Max. signal input value for ammeters		5 A AC
Display		3 digit LED display
Operating temperature	[°C]	-10...+55
Storage temperature	[°C]	-40...+70
Protection degree		IP20
Power consumption	[VA]	4
Modules		3
Overall dimensions front panel devices	[mm]	36x72x61.5 (51.5 depth inside the switchboard)

# Overall dimensions

## ODINsingle

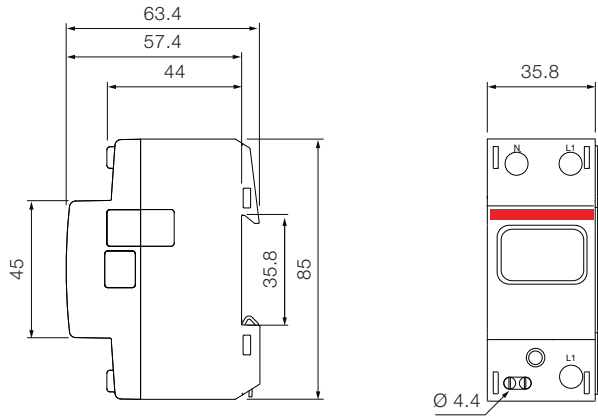

5

## EQ meters A41

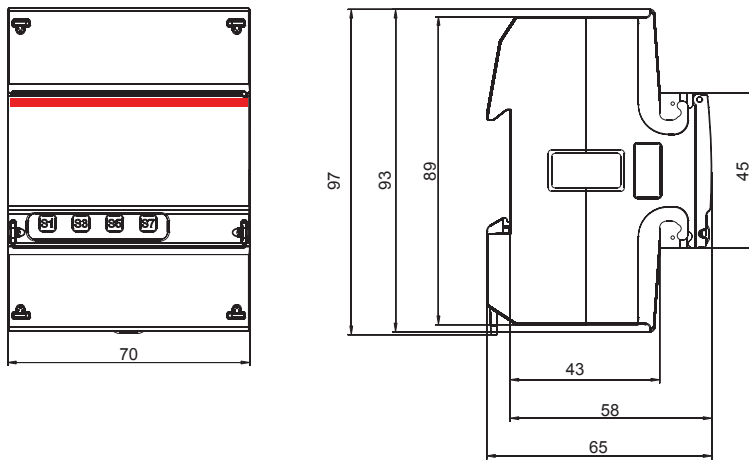

## ODIN

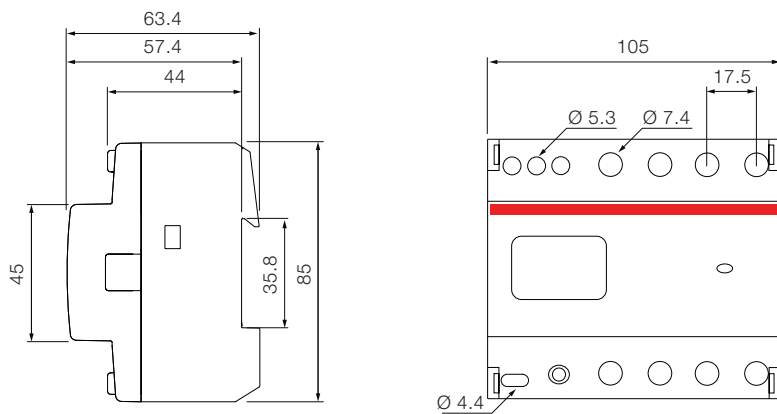

# Overall dimensions

## EQ meters A43

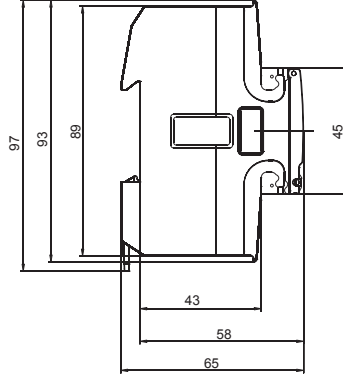
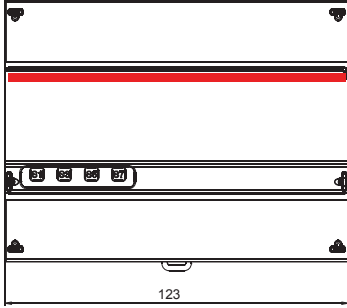

5

## Communication adapters

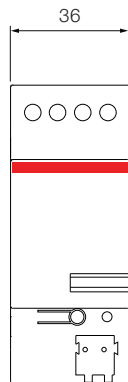
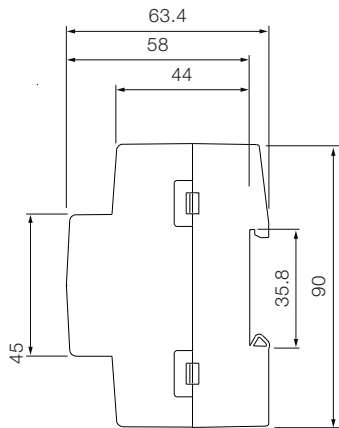



## AT

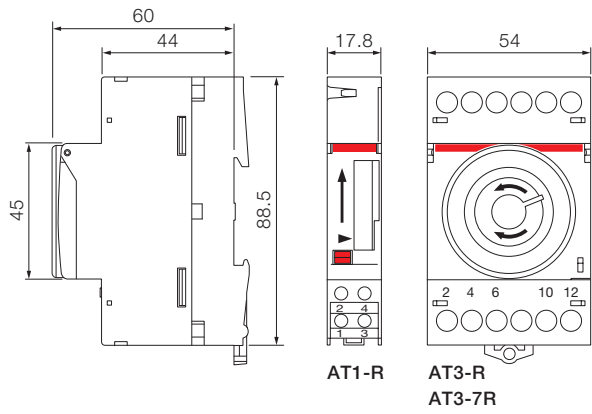

## D Line

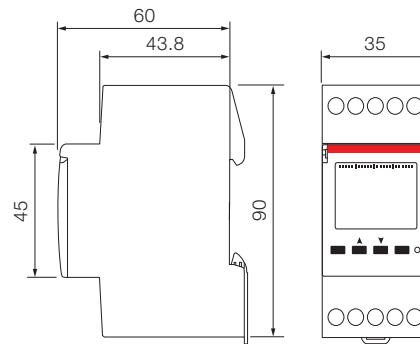

## E 232

E 232-230

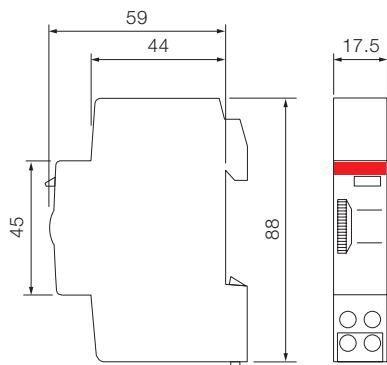

E 232 E - E 232 HLM

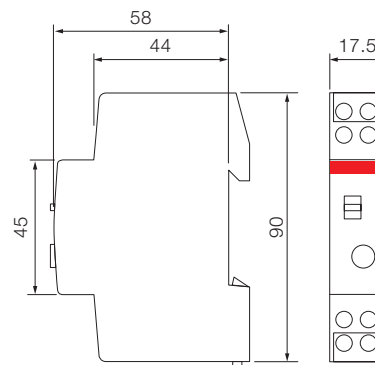

# Overall dimensions

## TW

TW1

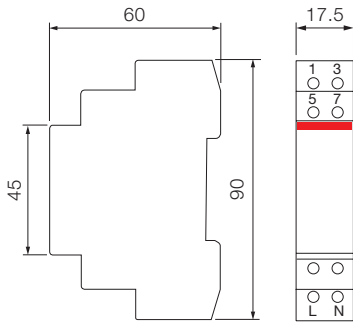

TW2/10K

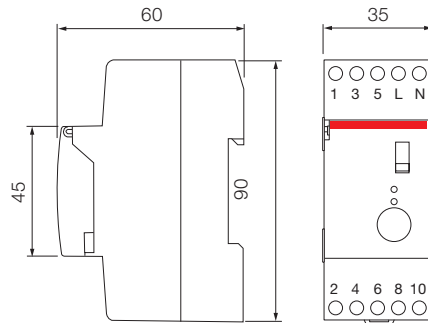

5

TWA-1

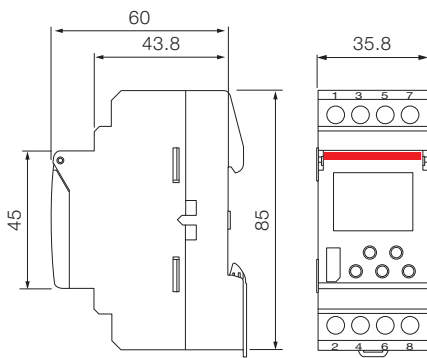

TWP

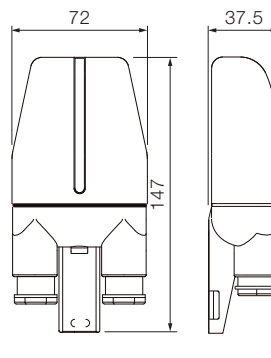

## E 233

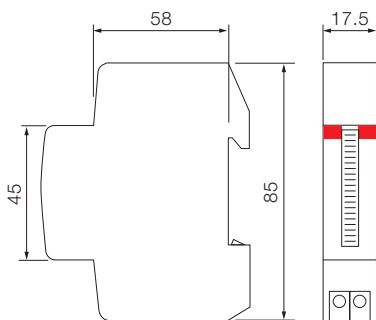

## VLMD, AMTD

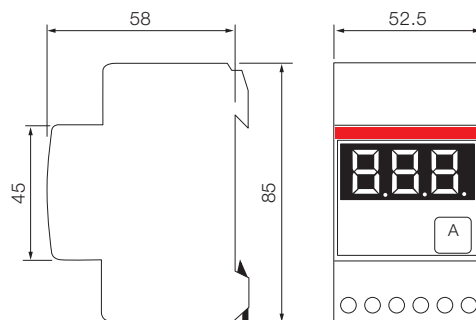

3 modules

# Consumer units and junction boxes

Introduction	6/2
<b>UK500 Flush-mounting Series</b>	
Plus of range	6/4
N/PE Quick-terminals	6/6
Ordering information	6/8
<b>Unibox Wall-mounting Series</b>	
Plus of range	6/20
Ordering information	6/22
<b>Alpha</b>	
Plus of range	6/26
Ordering information	6/28
<b>AT/U Series</b>	
Plus of range	6/30
N/PE Quick-terminals	6/32
Compact distribution boards	6/34
Ordering information	6/36
<b>IP65 Europa Series</b>	
Plus of range	6/52
Ordering information	6/54
<b>IP40 Wall-mounting covers</b>	
Plus of range	6/60
Ordering information	6/62
<b>IP44, IP55 and IP65 Junction boxes</b>	
Plus of range	6/64
Ordering information	6/66
<b>CJ8/16 Cable joint</b>	
Plus of range	6/74
Ordering information	6/75
Technical details	6/78
Overall dimensions	6/89

## Freedom of choice, the best solution for any need ABB Consumer units and Junction boxes

There has been a trend towards an ever increasing offer of products for residential installation. Technology is increasingly present in the domestic environment, and technological components are required to seamlessly integrate into the structure. ABB offers a wide range of consumer units for the installation of modular components to meet the requirements for domestic applications. The portfolio enables to implement any type of application for electrical distribution in residential and non-residential environments according to highest safety conditions and international regulations. The modularity of the products allows significant savings during installation.



Installation products for the residential application must respond to a series of specific requirements. Within the wide range of the ABB portfolio you can choose the electrical installation that fulfills the technical requirements and still looks good.

The **UK500 Series** sets a new aesthetical standard. The flush-mounting consumer unit offers a range of different designs which covers all customer's needs of elegance. The UK500 Series is an ideal combination of engineering and design, offering quick and flexible installation. The wall box is non-warp, non-breakable and non-flammable. It offers a large wiring space. The installation process is simple, quick and well thought-out. Various types of doors adapt all furnishing styles, from classic to modern as well as for multi-media applications.

The **Unibox Series** is distinguished by an advanced and elegant design which complements easy installation and user-friendliness. These IP40 wall-mounting consumer units perfectly fit into any architectural style. The range accommodates configurations from 8 to 54 modules which can be easily wired extracting the frame. Resistance to chemical agents, atmospheric agents, UV rays and shocks is guaranteed. Its wide set of accessories completes the functions of these units.

The range of **IP40 wall-mounting covers** also offers 2,4 and 6 module housings for electrical devices.

ABB offers with the **Alpha Series** enhanced features for your comfort. The Alpha Series with 18 modules per row comes with a smoky brown door which can be opened wide (210°), to allow easy access to the protective and control devices, if required. The wall-mounting Alpha enclosure is not only easy and quick to assemble, but also its timeless design ensures that it also fits harmoniously in any environment, for residential as well as for tertiary applications.

Whether for high-end residential or for tertiary sectors, the range of the **AT/U Series** offers a solution for every application. Specially designed accessories and spare parts guarantee that the AT/U Series will be a flexible and reliable partner for various applications – for flush-mounting as well as for wall-mounting or for hollow-wall-mounting. ABB provides with the AT/U compact distribution boards one complete solution for all electrical installation requirements in your home and makes the work easier for the electrical contractor.

The high level of reliability of the various models of watertight boxes of ABB, perfectly meets the need for watertight enclosures which guarantee complete protection in any situation where watertight consumer units and wall-mounted junction boxes are required. In industrial and tertiary, as well as in residential outdoor applications (heating rooms, garages, cellars, etc.) ABB's watertight boxes fulfill any requirements of robustness, reliability and ease of installation. The **IP65 Europa watertight consumer units** are available in RAL 9016 white and in RAL 7035 grey and can be equipped with blind and transparent doors. Designed for the use of the UNIFIX SL fast wiring system, IP65 Europa switchboards can be fitted with modular terminal boards.

To further enhance the existing range of **IP44 and IP55 watertight boxes**, ABB has expanded the portfolio by the IP65 junction boxes. The new range of **IP65 boxes** (with smooth sides) are now in halogen free thermoplastic material. ABB's range of consumer units and junction boxes present a safe use even under the most difficult environmental conditions: In particular the unique design of ABB's **able joint CJ8/16** eliminates the need for foam seals. Cables can be connected outside the casing and offers ample space for both joining and derivation.



# UK500 Flush-mounting Series

## The details make the difference

Cover with sealable 90° quick-action locking screws

Time-saving installation thanks to intelligent plug-in technology in the form of the N/PE quick busbar

6

Design doors, picture frame, stainless steel, transparent and differently coloured doors available as an accessory

Wall box made of torsionally-rigid, non-breakable, flame-resistant, low-halogen plastic with cable entry slides

UK500 series can be used for flush-mounting, hollow-wall or as a wall-mounting version, as well as for partially-recessed mounting



Removable cable inlet allows easy insertion of incoming and outgoing cables and uses a quick, single-hand-operated push and-stay design. Both cable inlets can be screwed tight when installation is complete.

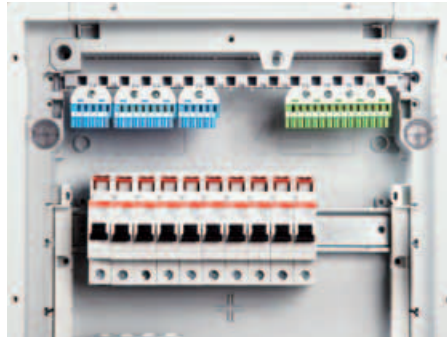

The non-warp, non-breakable and non-flammable wall box offers large wiring space. The strain-relief comb for neat cabling is an integral part of the wall box. There are ample further pre-formed cable entry points on the sides and back of the wall box.



All UK500 Series are suitable for hollow-wall installation. Upgrading is incredibly quick and simple – just as easy as the hollow wall installation itself. You just need the UZ90P4 hollow wall set for UK500. No screws, yet nothing can slip. Fastening it is as easy as fastening cable ties.

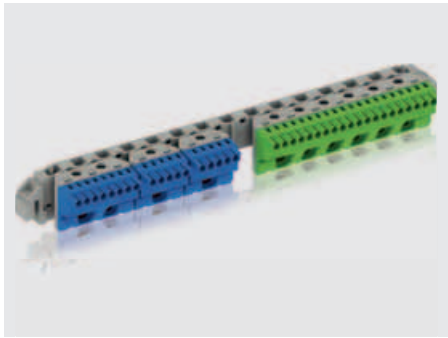

Time-saving installation thanks to intelligent plug-in technology. The N/PE Quick busbars are of the plug-in variety. If required, the N-RCD terminal can also be attached to the DIN rail and will not twist. There are also versions available with screw-type terminals.



Multifunctional wall grips: Can be used as a spacer when mounting consumer units side by side or to adjust the mounting depth by two more levels.



The removable device support can be snapped in and is installed quickly without tools. Here too, a variety of common installation techniques have been catered for – the device support can also be fixed in position using screws.



The “tech line” control panel of the UK500 Series offers that extra bit more. The monitoring and operation such as the control of lighting systems is taken care of by the control panel in a way that’s both easy-to view and decorative. The control panel can be finished by the user or supplied already wired and printed by the factory.



The rapid development of information technologies means that ever more media and communication devices are to be found in homes. In the new multimedia enclosure you have all your media applications at a glance with the central assembly of media and communications technology in distribution cabinets.



Functional yet elegant – a perfect example of how easy it can be to combine these two essential features. Beautiful and perfectly formed – the design doors for the UK500 Series are an embodiment of the design principle based on reducing things right down to the essentials. You would never believe that these high-quality design doors conceal a technical product.



# N/PE Quick-terminals

## Standardised, future-oriented and flexible

The new N/PE Quick-terminals from STRIEBEL & JOHN are designed for the things to come. Conforming to the current standard DIN VDE 0100 Part 410 and extremely flexible in terms of expandability, these N/PE Quick-terminals are unmatched for safe, efficient and future-oriented conductor connections.

As an electrician you no longer have to compromise. The new N/PE Quick-terminals from STRIEBEL & JOHN can simplify your work: Just choose the right terminal blocks and plug them in! The resulting installation is tidy and flexible. The colour coding ensures that you will find your way even with expansions.

### Product benefits

- Compliance with DIN VDE 0100 Part 410 (protection against electric shock)
- Flexible terminal system for several N power circuits: Screw connections: 2.5 to 25 mm<sup>2</sup>; spring terminals: 1.5 to 4 mm<sup>2</sup>.
- Optimal when using several residual current circuit breaker (RCDs)
- Combination of several Quick-terminals on one common quick carrier
- Ease of expansion using connecting bridges
- Precise assignment of the terminal blocks (clear colour coding: N = blue, PE = yellow-green)
- Easy labelling of the terminals (DIN VDE 0603 Part 1) using pre-printed, self-adhesive number strips
- Wide range of applications: can be used in the UK500 and A300 consumer unit series, in all compact distribution boards, and with all meter cabinets, wall-mounting and floor-standing cabinets
- The new terminal system replaces the N/PE Quick-busbars that were previously in use

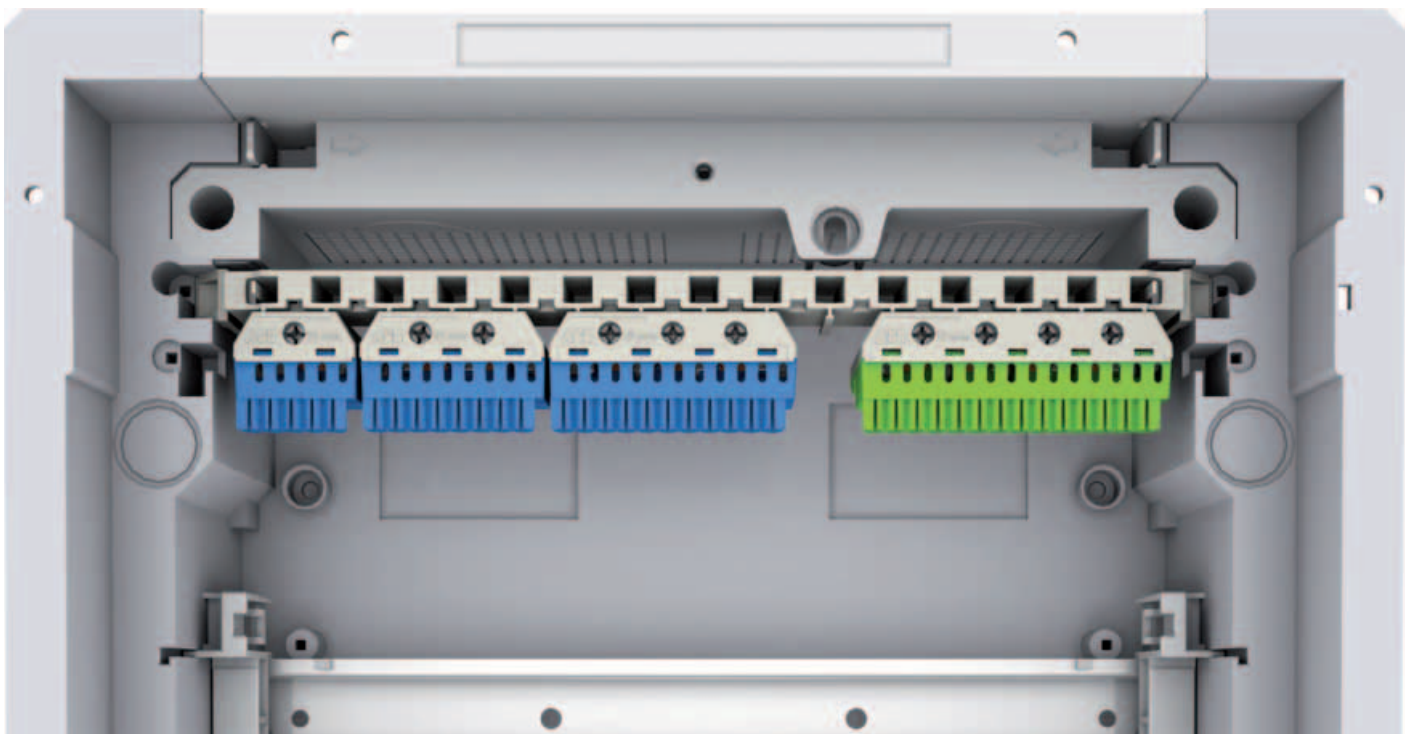



# N/PE Quick-terminals

## The complete range of products

### Clean and tidy work

Anyone would like their distribution board so tidy: all Quick-terminals are mounted next to each other on one carrier with standardised colour coding.

### Configure based on your needs

The modularity of the new series and the extensive range of products allow customising the new products to the needs based on real-world use. Various Quick-terminals can be combined on one quick carrier as necessary.

### Flexible by design

You need a larger N terminal? No problem. You can connect individual Quick-terminals with connecting bridges and remain in compliance with the technical requirements of IEC 60364-4-41 and DIN VDE 0100 Part 410 in an economic way.

The high flexibility of the new series is a crucial advantage here and in other solutions. The ability to combine terminal blocks with different numbers of terminals offers numerous possibilities.

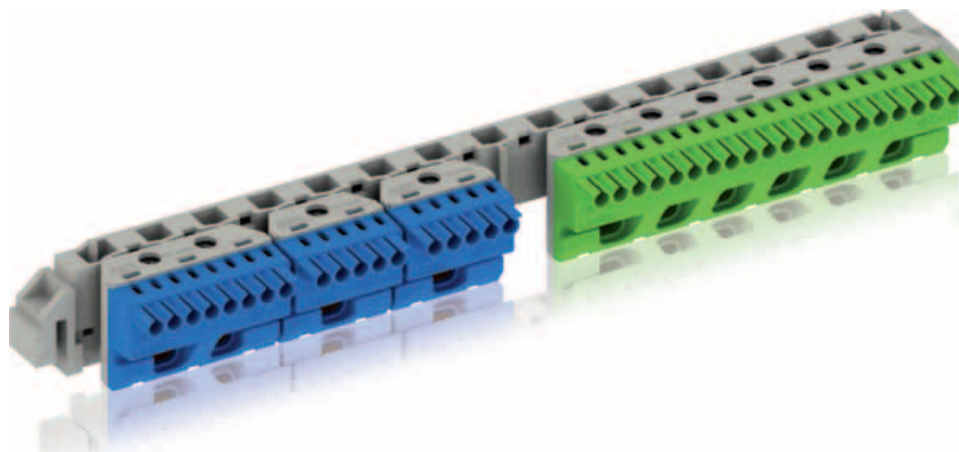

### N Quick-terminals

	1 x 25 mm <sup>2</sup> + 5 x 1.5 - 4 mm <sup>2</sup>
	2 x 25 mm <sup>2</sup> + 8 x 1.5 - 4 mm <sup>2</sup>
	3 x 25 mm <sup>2</sup> + 11 x 1.5 - 4 mm <sup>2</sup>
	4 x 25 mm <sup>2</sup> + 14 x 1.5 - 4 mm <sup>2</sup>
	5 x 25 mm <sup>2</sup> + 17 x 1.5 - 4 mm <sup>2</sup>
	6 x 25 mm <sup>2</sup> + 20 x 1.5 - 4 mm <sup>2</sup>
	0 x 25 mm <sup>2</sup> + 5 x 1.5 - 4 mm <sup>2</sup>

### PE Quick-terminals

	1 x 25 mm <sup>2</sup> + 5 x 1.5 - 4 mm <sup>2</sup>
	2 x 25 mm <sup>2</sup> + 8 x 1.5 - 4 mm <sup>2</sup>
	3 x 25 mm <sup>2</sup> + 11 x 1.5 - 4 mm <sup>2</sup>
	4 x 25 mm <sup>2</sup> + 14 x 1.5 - 4 mm <sup>2</sup>
	5 x 25 mm <sup>2</sup> + 17 x 1.5 - 4 mm <sup>2</sup>
	6 x 25 mm <sup>2</sup> + 20 x 1.5 - 4 mm <sup>2</sup>

# Complete version UK500N with trim frame and doors

## With the new N/PE Quick-terminals



### Flush-mounted consumer units – UK500N, IP30

I<sub>n</sub> up to 63 A

Consumer unit DIN VDE 0603-1, DIN 43871

Available in 1 up to 4 row versions as flush-mounted consumer units

Upgradeable for hollow-wall mounting using UZ90P4

Wall box:

- Non-warp, break-proof, non-flammable, low-halogen plastic
- With cable strain relief comb
- With detachable cable inlets

Wall grips

Removable device support

#### With the new N/PE Quick-terminals

Cover with 90° quick-action screws, lead-sealable

45 mm slots for 12 devices, expandable to 14

Labelling system

Trim frame and sheet steel door, adjustable for uneven surface

Colour: White, RAL 9016

\* In connection with UZ90P4

6



2CSC400030F0600

UK512N2



2CSC400030F0601

UK524N3



2CSC400030F0602

UK536N3



2CSC400030F0603

UK548N3

Article	H x W x D in mm	SU	Type	Ord. no.	Price
<b>Flush-mounted consumer units, 1-row</b>					
Niche dimensions	335 x 350 x 95	12 (13)	UK512N2	2CPX031281R9999	
Wall cut out dimensions for hollow-wall mounting	308 x 327 x 88				
<b>Flush-mounted consumer units, 2-row</b>					
Niche dimensions	460 x 350 x 95	24 (28)	UK524N3	2CPX031282R9999	
Wall cut out dimensions for hollow-wall mounting	433 x 327 x 88				
<b>Flush-mounted consumer units, 3-row</b>					
Niche dimensions	585 x 350 x 95	36 (41)	UK536N3	2CPX031283R9999	
Wall cut out dimensions for hollow-wall mounting	558 x 327 x 88				
<b>Flush-mounted consumer units, 4-row</b>					
Niche dimensions	710 x 350 x 95	48 (56)	UK548N3	2CPX031284R9999	
Wall cut out dimensions for hollow-wall mounting	683 x 327 x 88				

> Dimensions and technical details, see page 6/78 and 6/89

# N/PE Quick-terminals

## Accessories / Equipment in the UK500N



2CSC400030F0604

ZK113B



2CSC400030F0605

ZK50BT



2CSC400030F0606

ZK113G



2CSC400030F0607

ZK10P10



2CSC400030F0608

ZK11



2CSC400030F0609

ZK15

Article	Number of terminals 1.5 - 4 mm <sup>2</sup>	Number of terminals 2.5 - 25 mm <sup>2</sup>	External dimensions H x W x D in mm	Pcs.	Type	Ord. no.	Price
<b>N Quick-terminals</b>							
For quick carriers	5	0	23 x 32 x 21	1	ZK50B	2CPX062750R9999	
	5	1	32 x 32 x 31	1	ZK51B	2CPX062751R9999	
	8	2	32 x 49 x 31	1	ZK82B	2CPX062752R9999	
	11	3	32 x 65 x 31	1	ZK113B	2CPX062753R9999	
	14	4	32 x 82 x 31	1	ZK144B	2CPX062754R9999	
	17	5	32 x 98 x 31	1	ZK175B	2CPX062755R9999	
	20	6	32 x 115 x 31	1	ZK206B	2CPX062756R9999	
<b>N Quick-terminal with adapter ZK15</b>							
For lateral assembly to the UK5... , A3... or for fastening to the DIN rail	5	0	28 x 39 x 25	1	ZK50BT	2CPX062745R9999	
<b>PE Quick-terminals</b>							
For quick carriers	5	1	32 x 32 x 31	1	ZK51G	2CPX062757R9999	
	8	2	32 x 49 x 31	1	ZK82G	2CPX062758R9999	
	11	3	32 x 65 x 31	1	ZK113G	2CPX062759R9999	
	14	4	32 x 82 x 31	1	ZK144G	2CPX062760R9999	
	17	5	32 x 98 x 31	1	ZK175G	2CPX062761R9999	
	20	6	32 x 115 x 31	1	ZK206G	2CPX062762R9999	
<b>Connecting bridges</b>							
For Quick-terminals				10	ZK10P10	2CPX062763R9999	
<b>Quick carriers</b>							
For consumer units UK5... Usable width for Quick-terminals 247 mm				1	ZK11	2CPX064980R9999	
<b>Adapter for ZK50B</b>							
Engaging the ZK50B N Quick-terminal in the adapter ZK15, leads to ZK50BT to be laterally fastened UK5... , A3 or to the DIN rail				1	ZK15	2CPX064984R9999	

6

Article	Type	Equipment with new N/PE Quick-terminals*			
		UK512N2	UK524N3	UK536N3	UK548N3
Quick carrier for UK500N	ZK11	1 pc.	1 pc.	1 pc.	1 pc.
Adapter for ZK50B	ZK15			1 pc.	1 pc.
N Quick-terminal	ZK50B		1 pc.	1 pc.	1 pc.
	ZK51B	1 pc.			
	ZK82B	1 pc.	2 pcs.		1 pc.
	ZK113B			2 pcs.	
	ZK144B				1 pc.
PE Quick-terminal	ZK113G	1 pc.			
	ZK144G		1 pc.		
	ZK175G			1 pc.	
	ZK206G				1 pc.

\* Included in the scope of delivery

# Basic version UK500BN without trim frame and doors

## With the new N/PE Quick-terminals

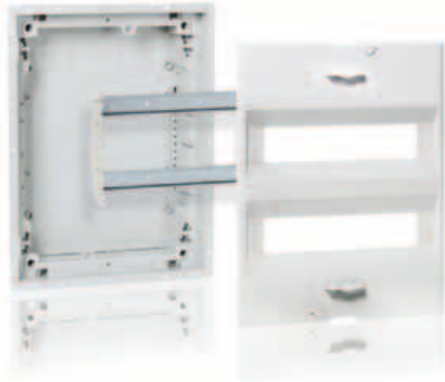

### Flush-mounted consumer units – UK500BN, IP30

I<sub>n</sub> up to 63 A

Consumer unit DIN VDE 0603-1, DIN 43871

Available in 1 up to 4 row versions as flush-mounted consumer units

Upgradeable for hollow-wall mounting using UZ90P4

Wall box:

- Non-warp, break-proof, non-flammable, low-halogen plastic
- With cable strain relief comb
- With detachable cable inlets

Wall grips

Removable device support

### With the new N/PE Quick-terminals

Cover with 90° quick-action screws, lead-sealable

45 mm slots for 12 devices, expandable to 14

Labelling system

\* In connection with UZ90P4

6



2CSC400030F0610

UK512BN



2CSC400030F0611

UK524BN



2CSC400030F0612

UK536BN



2CSC400030F0613

UK548BN

Article	H x W x D in mm	SU	Type	Ord. no.	Price
<b>Flush-mounted consumer units, 1-row</b>					
Niche dimensions	335 x 350 x 95	12 (14*)	UK512BN2	2CPX031285R9999	
Wall cut out dimensions for hollow-wall mounting	308 x 327 x 88				
<b>Flush-mounted consumer units, 2-row</b>					
Niche dimensions	460 x 350 x 95	24 (28)	UK524BN3	2CPX031286R9999	
Wall cut out dimensions for hollow-wall mounting	433 x 327 x 88				
<b>Flush-mounted consumer units, 3-row</b>					
Niche dimensions	585 x 350 x 95	36 (42*)	UK536BN3	2CPX031287R9999	
Wall cut out dimensions for hollow-wall mounting	558 x 327 x 88				
<b>Flush-mounted consumer units, 4-row</b>					
Niche dimensions	710 x 350 x 95	48 (56)	UK548BN3	2CPX031288R9999	
Wall cut out dimensions for hollow-wall mounting	683 x 327 x 88				

\* In connection with a standard door, "vision line" or "color line" with TIP-in closure there will be one space unit less.

> Dimensions and technical details, see page 6/8

# N/PE Quick-terminals

## Accessories / Equipment with UK500BN



2CSC400030F0604

ZK113B



2CSC400030F0605

ZK50BT



2CSC400030F0606

ZK113G



2CSC400030F0607

ZK10P10



2CSC400030F0608

ZK11



2CSC400030F0609

ZK15

Article	Number of terminals 1.5 - 4 mm <sup>2</sup>	Number of terminals 2.5 - 25 mm <sup>2</sup>	External dimensions H x W x D in mm	Pcs.	Type	Ord. no.	Price
<b>N Quick-terminals</b>							
For quick carriers	5	0	23 x 32 x 21	1	ZK50B	2CPX062750R9999	
	5	1	32 x 32 x 31	1	ZK51B	2CPX062751R9999	
	8	2	32 x 49 x 31	1	ZK82B	2CPX062752R9999	
	11	3	32 x 65 x 31	1	ZK113B	2CPX062753R9999	
	14	4	32 x 82 x 31	1	ZK144B	2CPX062754R9999	
	17	5	32 x 98 x 31	1	ZK175B	2CPX062755R9999	
	20	6	32 x 115 x 31	1	ZK206B	2CPX062756R9999	
<b>N Quick-terminal with adapter ZK15</b>							
For lateral assembly to the UK5... , A3... or for fastening to the DIN rail	5	0	28 x 39 x 25	1	ZK50BT	2CPX062745R9999	
<b>PE Quick-terminals</b>							
For quick carriers	5	1	32 x 32 x 31	1	ZK51G	2CPX062757R9999	
	8	2	32 x 49 x 31	1	ZK82G	2CPX062758R9999	
	11	3	32 x 65 x 31	1	ZK113G	2CPX062759R9999	
	14	4	32 x 82 x 31	1	ZK144G	2CPX062760R9999	
	17	5	32 x 98 x 31	1	ZK175G	2CPX062761R9999	
	20	6	32 x 115 x 31	1	ZK206G	2CPX062762R9999	
<b>Connecting bridges</b>							
For Quick-terminals				10	ZK10P10	2CPX062763R9999	
<b>Quick carriers</b>							
For consumer units UK5... Usable width for Quick-terminals 247 mm				1	ZK11	2CPX064980R9999	
<b>Adapter for ZK50B</b>							
Engaging the ZK50B N Quick-terminal in the adapter ZK15, leads to ZK50BT to be laterally fastened UK5... , A3 or to the DIN rail				1	ZK15	2CPX064984R9999	

6

Article	Type	Equipment with new N/PE Quick-terminals*			
		UK512BN2	UK524BN3	UK536BN3	UK548BN3
Quick carrier for UK500BN	ZK11	1 pc.	1 pc.	1 pc.	1 pc.
Adapter for ZK50B	ZK15			1 pc.	1 pc.
N Quick-terminal	ZK50B		1 pc.	1 pc.	1 pc.
	ZK51B	1 pc.			
	ZK82B	1 pc.	2 pcs.		1 pc.
	ZK113B			2 pcs.	
	ZK144B				1 pc.
PE Quick-terminal	ZK113G	1 pc.			
	ZK144G		1 pc.		
	ZK175G			1 pc.	
	ZK206G				1 pc.

\* Included in the scope of delivery

# Complete version UK500 with trim frame and doors

## With screwable N/PE terminals



2CSC400030F0600

UK510E



2CSC400030F0601

UK520E



2CSC400030F0602

UK530E



2CSC400030F0603

UK540E

Article	H x W x D in mm	SU	Type	Ord. no.	Price
<b>Flush-mounted consumer units, 1-row</b>					
Niche dimensions for flush-mounting	335 x 350 x 95	12 (13)			
Wall cut out dimensions for hallow wall mounting	308 x 327 x 88				
With screwable N/PE terminals and sheet steel door			UK510E	2CPX077600R9999	
With screwable N/PE terminals and transparent door			UK510ETT	2CPX031017R9999	
Without N/PE terminals With sheet steel door			UK510KE	2CPX031001R9999	
With screwable N/PE terminals With sheet steel door and cable inlet for tubes		UK510SN	2CPX030819R9999		
<b>Flush-mounted consumer units, 2-row</b>					
Niche dimensions for flush-mounting	460 x 350 x 95	24 (28)			
Wall cut out dimensions for hallow wall mounting	433 X 327 x 88				
With screwable N/PE terminals and sheet steel door			UK520E	2CPX077601R9999	
With screwable N/PE terminals and transparent door			UK520ETT	2CPX031018R9999	
Without N/PE terminals With sheet steel door			UK520KE	2CPX031002R9999	
With screwable N/PE terminals With sheet steel door and cable inlet for tubes		UK520SN	2CPX030820R9999		
<b>Flush-mounted consumer units, 3-row</b>					
Niche dimensions for flush-mounting	585 x 350 x 95	36 (41)			
Wall cut out dimensions for hallow wall mounting	558 X 327 x 88				
With screwable N/PE terminals and sheet steel door			UK530E	2CPX077602R9999	
With screwable N/PE terminals and transparent door			UK530ETT	2CPX031019R9999	
Without N/PE terminals With sheet steel door			UK530KE	2CPX031003R9999	
With screwable N/PE terminals With sheet steel door and cable inlet for tubes		UK530SN	2CPX030821R9999		
<b>Flush-mounted consumer units, 4-row</b>					
Niche dimensions for flush-mounting	710 x 350 x 95	48 (56)			
Wall cut out dimensions for hallow wall mounting	683 X 327 x 88				
With screwable N/PE terminals and sheet steel door			UK540E	2CPX077603R9999	
With screwable N/PE terminals and transparent door			UK540ETT	2CPX031020R9999	
Without N/PE terminals With sheet steel door			UK540KE	2CPX031004R9999	
With screwable N/PE terminals With sheet steel door and cable inlet for tubes		UK540SN	2CPX030822R9999		

> Dimensions and technical details, see page 6/8

# Multimedia enclosures with and without trim frame and doors

## Consumer units with control panel FPT500



UK530MV

2CSC400030F0614



UZM530MV

2CSC400030F0615



FPT520

2CSC400030F0616

Article	Remark	H x W x D in mm	Type	Ord. no.	Price
<b>Flush-mounted multimedia enclosures with doors</b>					
Wall box with perforated sheet steel mounting plate, wire holders, DIN rail, wall grips, double socket with euro-plug insert, trim frame and door with ventilation holes	Niche dimensions	585 x 350 x 95	UK530MV	2CPX030839R9999	
	Wall cut out dimensions	558 x 327 x 88			
	Mounting plate dimensions	447 x 277 x 1.5			
Niche dimensions	710 x 350 x 95	UK540MV	2CPX030840R9999		
	Wall cut out dimensions				638 x 327 x 88
	Mounting plate dimensions				572 x 277 x 1.5
<b>Flush-mounted multimedia enclosures without doors</b>					
with perforated sheet steel mounting plate, wire holders, DIN rail and wall grips	Niche dimensions	585 x 350 x 95	UZM530MV	2CPX030985R9999	
	Wall cut out dimensions	558 x 327 x 88			
	Mounting plate dimensions	447 x 277 x 1.5			
Niche dimensions	710 x 350 x 95	UM540MV	2CPX030986R9999		
	Wall cut out dimensions				683 x 327 x 88
	Mounting plate dimensions				572 x 277 x 1.5

Article	Internal dimensions of the control panel H x W in mm	External dimensions of the control panel H x W x D in mm	Type	Ord. no.	Price
<b>Consumer units with control panel</b>					
Wall box with device support, removable DIN rails; aluminium control panel unprinted and unwired; the control panel can be finished by the user or supplied already wired and printed by the factory; control panels must only be mounted in vertical direction; door hinged right	282 x 293	362 x 374 x 22	FPT510	2CPX030825R9999	
	403 x 293	487 x 374 x 22	FPT520	2CPX030826R9999	
	528 x 293	612 x 374 x 22	FPT530	2CPX030827R9999	

- > Dimensions and technical details, see page 6/8
- > Useable space of the control panel, see page 6/90



# Multimedia enclosures

## Accessories



ZX29

2CSC400030F0617



ZE225

2CSC400030F0618



ED57P10

2CSC400030F0619



ED44P10

2CSC400030F0620



ZX287P10

2CSC400030F0621

Article	Pcs.	Type	Ord. no.	Price
<b>Cross member</b>				
For double socket	1	ZX29	2CPX061178R9999	
<b>Double socket with euro-plug insert</b>				
For supplying 230 V power to power supplies	1	ZE225	2CPX061177R9999	
<b>Adapter</b>				
To fasten the ED44P10 wire holder to the perforated sheet steel mounting plate	10	ED57P10	2CPX061179R9999	
<b>Wire holder</b>				
28.5 mm	10	ED44P10	2CPX062335R9999	
<b>Screws M4 x14 thread rolling</b>				
For the perforated sheet steel mounting plate	10	ZX287P10	2CPX061180R9999	



# Doors for UK500

## Door selection



2CSC400030F0622

BL5



2CSC400030F0623

BL528D



2CSC400030F0624

BL521D



2CSC400030F0625

BL527D

Article	To be used with...	Internal dimensions of the trim cover H x W x D in mm	External dimensions of the trim cover H x W x D in mm	Type	Ord. no.	Price
<b>Trim frame with door (complete version)</b>						
Colour: white, RAL 9016 Sheet steel, powder coated	UK51...	282 x 297 x 33	352 x 367 x 9	BL510	2CPX030853R9999	
	UK52...	407 x 297 x 33	477 x 367 x 9	BL520	2CPX030854R9999	
	UK53...	532 x 297 x 33	602 x 367 x 9	BL530	2CPX030855R9999	
	UK54...	657 x 297 x 33	727 x 367 x 9	BL540	2CPX030856R9999	
<b>art line</b>						
Brushed stainless steel	UK52...	407 x 297 x 33	490 x 407 x 39	BL528D	2CPX030918R9999	
	UK53...	532 x 297 x 33	615 x 407 x 39	BL538D	2CPX030919R9999	
<b>addition line</b>						
Picture frame door Brushed aluminium	UK52...	407 x 297 x 27	487 x 378 x 26	BL521D	2CPX030858R9999	
	UK53...	532 x 297 x 27	612 x 378 x 26	BL531D	2CPX030859R9999	
Picture frame door Colour: white, RAL 9016	UK52...	407 x 297 x 27	487 x 374 x 22	BL527D	2CPX030897R9999	
	UK53...	532 x 297 x 27	612 x 374 x 22	BL537D	2CPX030898R9999	

> Dimensions and technical details, see page 6/14

> Dimensions picture frame doors, see page 6/14

# Doors for UK500

## Door selection



BL516C

2CSC400030F0426



BL517C

2CSC400030F0427



BL518C

2CSC400030F0428

6



BL510K

2CSC400030F0429



BL530L

2CSC400030F0430

Article	To be used with...	Internal dimensions of the trim cover H x W x D in mm	External dimensions of the trim cover H x W x D in mm	Type	Ord. no.	Price
<b>color line</b>						
Trim frame with door Colour: anthracite RAL 7016	UK51...	282 x 297 x 33	352 x 367 x 9	BL516C	2CPX031251R9999	
	UK52...	407 x 297 x 33	477 x 367 x 9	BL526C	2CPX031252R9999	
	UK53...	532 x 297 x 33	602 x 367 x 9	BL536C	2CPX031253R9999	
	UK54...	657 x 297 x 33	727 x 367 x 9	BL546C	2CPX031254R9999	
Trim frame with door Colour: silver RAL 9006	UK51...	282 x 297 x 33	352 x 367 x 9	BL517C	2CPX031255R9999	
	UK52...	407 x 297 x 33	477 x 367 x 9	BL527C	2CPX031256R9999	
	UK53...	532 x 297 x 33	602 x 367 x 9	BL537C	2CPX031257R9999	
	UK54...	657 x 297 x 33	727 x 367 x 9	BL547C	2CPX031258R9999	
Trim frame with door Colour: light grey RAL 7035	UK51...	282 x 297 x 33	352 x 367 x 9	BL518C	2CPX031259R9999	
	UK52...	407 x 297 x 33	477 x 367 x 9	BL528C	2CPX031260R9999	
	UK53...	532 x 297 x 33	602 x 367 x 9	BL538C	2CPX031261R9999	
	UK54...	657 x 297 x 33	727 x 367 x 9	BL548C	2CPX031262R9999	
<b>vision line</b>						
Transparent door	UK51...	282 x 297 x 33	352 x 367 x 9	BL510K	2CPX030835R9999	
	UK52...	407 x 297 x 33	477 x 367 x 9	BL520K	2CPX030836R9999	
	UK53...	532 x 297 x 33	602 x 367 x 9	BL530K	2CPX030837R9999	
	UK54...	657 x 297 x 33	727 x 367 x 9	BL540K	2CPX030838R9999	
<b>media line</b>						
Trim frame and door with ventilation holes Colour: white, RAL 9016 Sheet steel, powder-coated	UZM530MV	532 x 297 x 33	602 x 367 x 9	BL530L	2CPX030990R9999	
	UZM540MV	657 x 297 x 33	727 x 367 x 9	BL540L	2CPX030991R9999	

Dimensions and technical details, see page 1/28

# Consumer units UK500

## Accessories



UZ7

2CSC400030F0681



UZM5

2CSC400030F0632



UZ4P2

2CSC400030F0633



UZ530G

2CSC400030F0634



UZ510A

2CSC400030F0635



UZ90P4

2CSC400030F0636



AP5

2CSC400030F0637



ZK502

2CSC400030F0638



ZK505

2CSC400030F0639



ZK506

2CSC400030F0639



ZK507

2CSC400030F0640



ZA120

2CSC400030F0641

Article	Pcs	Type	Ord. no.	Price
<b>Door hinge set</b> UK500	1	UZ7	2CPX030917R9999	
<b>Wall box with wall grips</b>				
To be used with UK51...	1	UZM510	2CPX030805R9999	
To be used with UK52...	1	UZM520	2CPX030806R9999	
To be used with UK53...	1	UZM530	2CPX030807R9999	
To be used with UK54...	1	UZM540	2CPX030808R9999	
<b>Wall grips</b>				
To fix the wall box in two mounting depths	4	UZ4P2	2CPX062447R9999	
<b>DIN rail with device support</b>				
To be used with UK51...	1	UZ510G	2CPX030841R9999	
To be used with UK52...	1	UZ520G	2CPX030842R9999	
To be used with UK53...	1	UZ530G	2CPX030843R9999	
To be used with UK54...	1	UZ540G	2CPX030844R9999	
<b>Cover with 90° quick-action screws</b>				
To be used with UK51...	1	UZ510A	2CPX030845R9999	
To be used with UK52...	1	UZ520A	2CPX030846R9999	
To be used with UK53...	1	UZ530A	2CPX030847R9999	
To be used with UK54...	1	UZ540A	2CPX030848R9999	
<b>Hollow-wall mounting set</b>				
To modify the flush-mounting consumer unit into a hollow-wall consumer unit UK500 (type label and 20 cable ties included) wall thickness min. 8 mm, max. 35 mm	1	UZ90P4	2CPX062563R9999	
<b>On wall mounting set</b>				
For wall mounting or partially recessed installation				
To be used with UK51...	1	AP510	2CPX030849R9999	
To be used with UK52...	1	AP520	2CPX030850R9999	
To be used with UK53...	1	AP530	2CPX030851R9999	
To be used with UK54...	1	AP540	2CPX030852R9999	
<b>NP/E terminals</b>				
3 x 16 mm <sup>2</sup> + 14 x 4 mm <sup>2</sup> , Cu screwable (each)	1	ZK502	2CPX030887R9999	
<b>N terminals</b>				
5 x 16 mm <sup>2</sup> + 19 x 10 mm <sup>2</sup> , Cu screwable	1	ZK505	2CPX030890R9999	
<b>NP terminals</b>				
5 x 16 mm <sup>2</sup> + 19 x 10 mm <sup>2</sup> , Cu screwable	1	ZK506	2CPX030891R9999	
<b>N-RCD-busbar</b>				
3 x 16 mm <sup>2</sup> + 2 x 10 mm <sup>2</sup> Cu pluggable	1	ZK507	2CPX030892R9999	
<b>Touch-up applicator</b>				
Colour RAL 9016, 12 ml	1	ZA120	2CPX039043R9999	

# Consumer units UK500

## Accessories

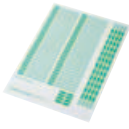

2CSC400030F0642

UZ3



2CSC400030F0643

ZA89P20

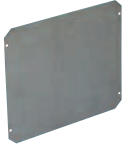

2CSC400030F0644

UZ510M



2CSC400030F0645

UZ530L



2CSC400030F0646

UZ2



2CSC400030F0647

UZ1



2CSC400030F0648

ZA3P5



2CSC400030F0649

UZ5



2CSC400030F0650

UZ52



2CSC400030F0651

UZ84

Article	Pcs.	Type	Ord. no.	Price
<b>Labelling system</b>				
Self-adhesive, for identifying circuits, 17.5 mm	1	UZ3	2CPX030882R9999	
<b>Screws</b>				
20 pcs. for fixing DIN rails and mounting plates	1	ZA89P20	2CPX062376R9999	
<b>Mounting plate, sheet steel, galvanised</b>				
H x W in mm				
130 x 255 to be used with UK510S	1	UZ510M	2CPX030872R9999	
255 x 255 to be used with UK520S	1	UZ520M	2CPX030873R9999	
380 x 255 to be used with UK530S	1	UZ530M	2CPX030874R9999	
505 x 255 UK540S	1	UZ540M	2CPX030875R9999	
<b>Perforated mounting plate for multimedia enclosures</b>				
H x W in mm				
447 x 227 UZM530MV	1	UZ530L	2CPX030992R9999	
572 x 227 to be used with UZM540MV	1	UZ540L	2CPX030993R9999	
<b>TIP-in-closure</b>				
Colour: white	1	UZ2	2CPX030885R9999	
<b>Closure with lock</b>				
With 2 keys	1	UZ1	2CPX030870R9999	
<b>Slot cover, 5 pcs.</b>				
Colour: white, RAL 9016	5	ZA3P5	2CPX062385R9999	
<b>Cable inlet for wall box</b>				
Top or bottom, 1 to 4 rows	1	UZ5	2CPX030871R9999	
<b>Vertical partition</b>				
1-row	1	UZ51	2CPX030878R9999	
2-row	1	UZ52	2CPX030879R9999	
3-row	1	UZ53	2CPX030880R9999	
4-row	1	UZ54	2CPX030881R9999	
<b>Horizontal partition</b>				
	1	UZ84	2CPX030877R9999	

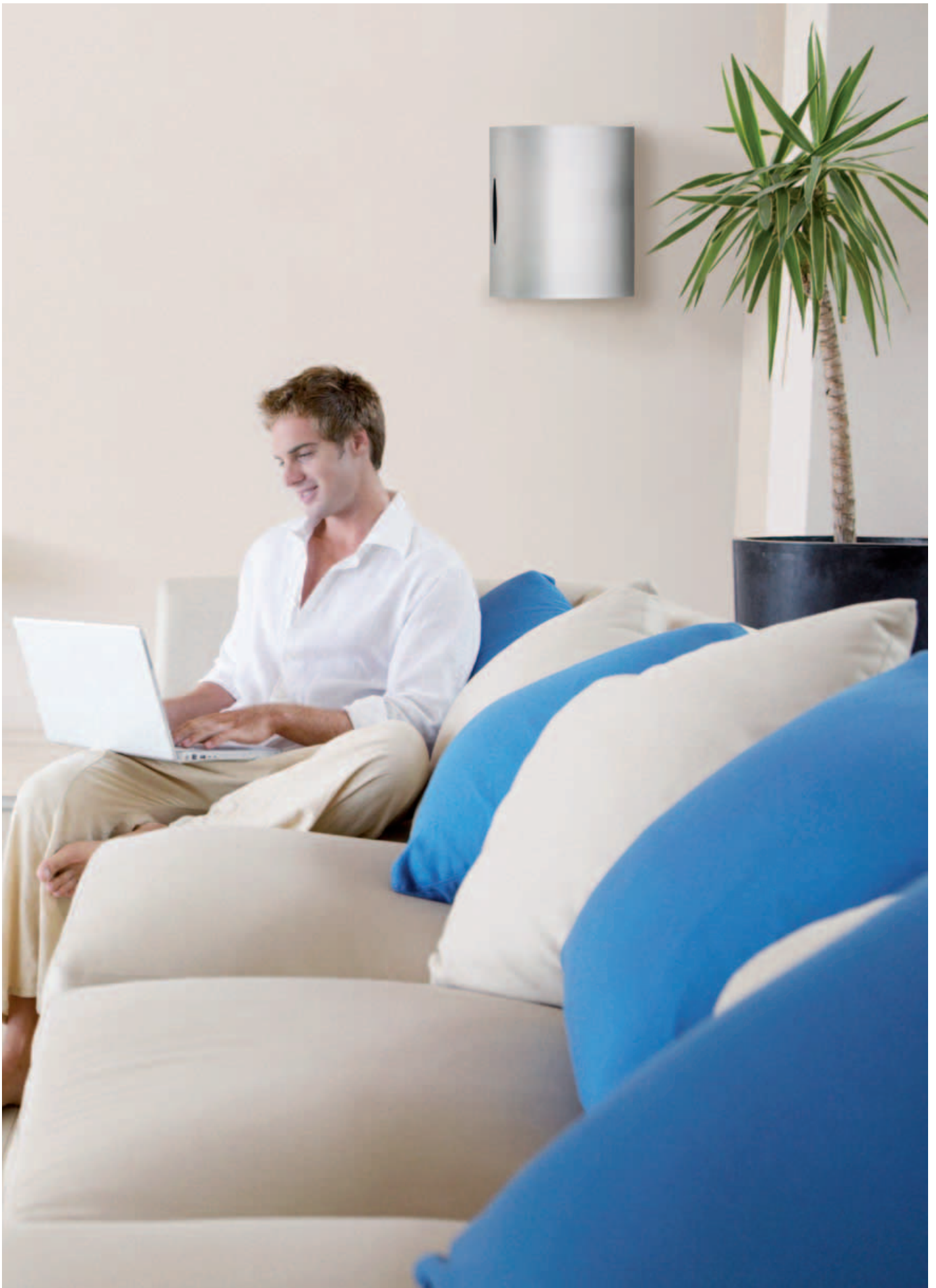

# Unibox Wall-mounting Series

## The details make the difference

The cover is fitted using rapid pitch screws in insulating thermo-plastic that can be lead-sealed if necessary

Extractable and inclinable frame, snap fixing onto the base; components and accessories are easy to assembly by snapping on, without the need for screws



Available dimensions from 8 up to 54 modules

Elegant attractive line following the latest trends in design (patented model)



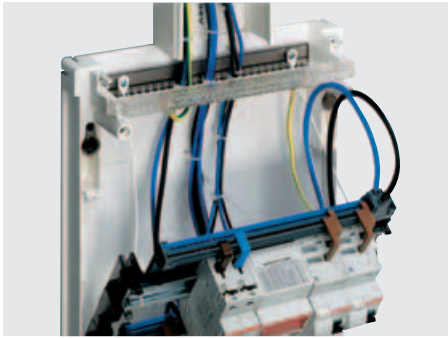

A characteristic of consumer units in the UNIBOX Series is the frame, which can be kept in an angled position thanks to practical wires, making it easier to work on the connection cables.



The consumer unit is designed with a flange so that it can be used for branch connection using a conduit. The knockouts make it possible to make branch connections with conduits with a maximum diameter of 40 mm.

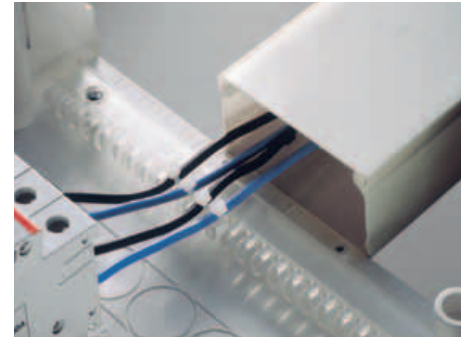

The practical holding system secures the incoming and outgoing cables to a special comb accessory, which not only keeps the cables tidy but also protects the devices' terminals from any direct mechanical contact.

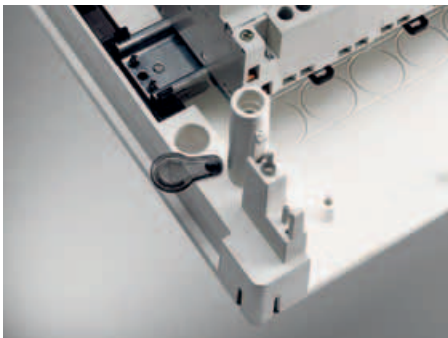

The special caps used to cover the holes for attaching to the wall ensure that the consumer unit is double insulated.



Complete with accessories for tidy wiring and for clamping of incoming and outgoing cables



Equipped with spring door closure employing the push-pull system, prepared for the fitting of a lock



Thanks to plenty of room under the DIN rail it is possible to install the cables tidily and rationalise their paths.



The knockouts in the cover give maximum flexibility in trunking branch connections. The knockout cut halfway down the module on both sides makes it possible to fit an extra module corresponding to each row of circuit breakers.

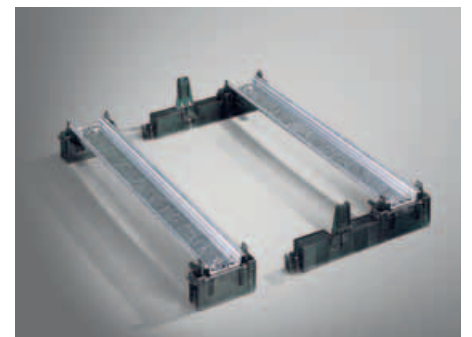

The modular, snap-on frame is easy to extract and is therefore ideal for bench cabling.

# Ordering Information

## Unibox Wall-mounting Series



Unibox 1-row with opaque door

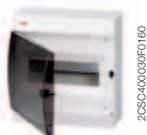

Unibox 1-row with transparent, smoky door



Unibox 1-row with opaque door



Unibox 1-row with transparent, smoky door



Unibox 2-row opaque door



Unibox 2-row transparent, smoky door

- Unibox wall-mounting series for residential applications (houses, flats).
- Rated current  $I_n = 125A$ ; Protection degree IP40; Protection class II (double insulated); Shock resistance 10 Joules (IK level 09).
- In thermoplastic, self-extinguishing and resistant to abnormal heat and fire up to 650°C (glow wire flammability index) in compliance with IEC 60695-2-11 Standard.
- Installation temperature from -25°C to +60°C; resistant to heat: ball thermopressure up to +85°C in compliance with EN 60695-10-2 Standard.
- Unibox consumer units are manufactured in compliance with CEI 23-49 (1996) + V1 + V2, CB certificate IEC 60670-24 Standards.
- IP40 Unibox Series wall-mounting consumer units obtained the IMQ mark of approval IMQ.
- Unibox consumer units are supplied complete with: module covers; protective film for door; cable-clip accessory; rigid flange for branch connections with conduits; 1 self-adhesive indicator strip per row; 1 plate for CEI 23-51 certification; instruction sheet; 4 protection caps.

Description	N° module [18 mm]	Dimensions HxWxD [mm]	Order code	Price
<b>1-row</b>				
Unibox, wall-mounting, RAL 9016, with opaque door	8	215x220x105	12238	
Unibox, wall-mounting, RAL 9016, with opaque door, with terminal bars (n°1 12531 + n°1 12532)	8	215x220x105	M12238000U	
Unibox, wall-mounting, RAL 9016, with transparent, smoky door	8	215x220x105	12258	
Unibox, wall-mounting, RAL 9016, with transparent, smoky door, with terminal bars (n°1 12531 + n°1 12532)	8	215x220x105	M12258000U	
Unibox, wall-mounting, RAL 9016, with opaque door	12	295x245x115	12242	
Unibox, wall-mounting, RAL 9016, with opaque door, with terminal bars (n°2 12535)	12	295x245x115	M12242000A	
Unibox, wall-mounting, RAL 9016, with transparent, smoky door	12	295x245x115	12262	
Unibox, wall-mounting, RAL 9016, with transparent, smoky door, with terminal bars (n°2 12535)	12	295x245x115	M12262000A	
<b>2-row</b>				
Unibox, wall-mounting, RAL 9016, with opaque door	24	295x390x115	12244	
Unibox, wall-mounting, RAL 9016, with opaque door, with terminal bars (n°2 12531 + n°2 12533)	24	295x390x115	M12244000U	
Unibox, wall-mounting, RAL 9016, with transparent, smoky door	24	295x390x115	12264	
Unibox, wall-mounting, RAL 9016, with transparent, smoky door, with terminal bars (n°2 12531 + n°2 12533)	24	295x390x115	M12264000U	





Unibox with opaque door



Unibox with transparent, smoky door



Unibox with opaque door



Unibox with transparent, smoky door

Description	N° module	Dimensions HxWxD	Order code	Price
	[18 mm]	[mm]		
<b>3-row</b> ☐				
Unibox, wall-mounting, RAL 9016, with opaque door	36	295x515x115	12246	
Unibox, wall-mounting, RAL 9016, with opaque door, with terminal bars (n°2 12531 + n°2 12534)	36	295x515x115	M12246000U	
Unibox, wall-mounting, RAL 9016, with transparent, smoky door	36	295x515x115	12266	
Unibox, wall-mounting, RAL 9016, with transparent, smoky door, with terminal bars (n°2 12531 + n°2 12534)	36	295x515x115	M12266000U	
<b>3-row</b> ☐				
Unibox, wall-mounting, RAL 9016, with opaque door	54	405x515x115	12247	
Unibox, wall-mounting, RAL 9016, with opaque door, with terminal bars (n°2 12535)	54	405x515x115	M12247000U	
Unibox, wall-mounting, RAL 9016, with transparent, smoky door	54	405x515x115	12267	
Unibox, wall-mounting, RAL 9016, with transparent, smoky door, with terminal bars (n°2 12535)	54	405x515x115	M12267000U	

### Terminal bars configuration

No modules	N (holes x mm <sup>2</sup> )	PE (holes x mm <sup>2</sup> )
8	(10 x 16) + (3 x 25)	(5 x 16)
12	(10 x 16) + (3 x 25)	(10 x 16) + (3 x 25)
24	(16 x 16) + (3 x 25) + (5 x 16)	(16 x 16) + (3 x 25) + (5 x 16)
36	(15 x 16) + (6 x 25) + (5 x 16)	(15 x 16) + (6 x 25) + (5 x 16)
54	(19 x 16) + (6 x 25)	(19 x 16) + (6 x 25)

# Ordering Information

## Unibox Wall-mounting Series

### Accessories



Terminal blocks

2CSC400030F0169



Terminal holders

2CSC400030F0170



Terminal bars

2CSC400030F0171



Spare doors

2CSC400030F0172

6

#### Terminal blocks

The complete terminal blocks are composed of a combination of terminal holders and terminal bars as indicated in the description, with the terminal bars already mounted on terminal holders. Configuration of the complete terminal block is standard. For different requirements (customized terminal block), the terminal holders and bars must be procured separately in the versions indicated in the table.

Description	Order code	Price	Box/Pack No items
<b>Terminal blocks</b>			
For 8 modules – composed of 12540x1 + 12531x1 + 12532x1	12492		10/40
For 12 modules – composed of 12541x1 + 12532x2	12495		10/40
For 24 modules – composed of 12541x2 + 12531x2 + 12533x2	12504		10/40
For 36 modules – composed of 12541x2 + 12531x2 + 12534x2	12505		10/40
For 54 modules – composed of 12542x2 + 12535x2	12501		5/20
<b>Terminal holders</b>			
For 8 modules – for Unibox 12238 and 12258	12540		12/144
For 12 modules per row – for Unibox 12262, 12244, 12264, 12246 and 12266	12541		12/144
For 18 modules per row – for Unibox 12247 and 12267	12542		12/108
The terminal block is completed by combining the necessary terminal bars to the terminal holders, taking care to keep the terminal bars separated from each other.			
<b>Terminal bars</b>			
5 holes x Ø 4.5	12531		20/240
10 holes Ø 4.5 mm and 3 holes Ø 5.6 mm <sup>2</sup>	12532		20/240
16 holes Ø 4.5 mm and 3 holes Ø 5.6 mm <sup>2</sup>	12533		20/240
15 holes Ø 4.5 mm and 6 holes Ø 5.6 mm <sup>2</sup>	12534		20/240
19 holes Ø 4.5 mm and 6 holes Ø 5.6 mm <sup>2</sup>	12535		20/240
The terminal bars can be installed on any kind of terminal holder; they are snapped onto these with 2 clips per bar, through two holes made at the ends of the bar itself.			
Terminal holders and terminal bars are supplied separately. In this way, by inserting one or two terminal bars into the terminal holder you can create the best terminal for your requirements, with the advantage of obtaining a terminal block that is cheap as well as personalized, due to the fact that you only need to use material that is really necessary. Some standard configurations are illustrated in the table. All the possible configurations that can be created for each type of consumer unit are given in the technical details.			
<b>Spare doors</b>			
Opaque door, RAL 9016 white, for Unibox 12238 and M12238000U	12511		1/25
Opaque door, RAL 9016 white, for Unibox 12242 and M12242000A	15212		1/15
Opaque door, RAL 9016 white, for Unibox 12244 and M12244000U	12513		1/10
Opaque door, RAL 9016 white, for Unibox 12246 and M12246000U	12514		1/5
Opaque door, RAL 9016 white, for Unibox 12247 and M12247000U	12515		1/5
Transparent, smoky door for Unibox 12258 and M12258000U	12521		1/25
Transparent, smoky door for Unibox 12262 and M12262000A	12522		1/15
Transparent, smoky door for Unibox 12264 and M12264000U	12523		1/10
Transparent, smoky door for Unibox 12266 and M12266000U	12524		1/5
Transparent, smoky door for Unibox 12267 and M12267000U	12525		1/5



2CSC400030F0173

Door accessories

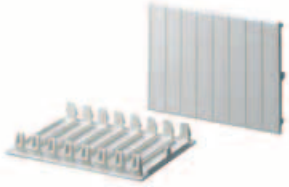

2CSC400030F0174

Closure



2CSC400030F0175

Coupling element



2CSC400030F0176

Spare doors

Description	Order code	Price	Box/Pack No items
<b>Door accessories</b>			
The mechanism for push-pull code No 12526 (in packs of 5 items) should be always ordered with each door.	12526		1/1
<b>Closure</b>			
Lock with Key for Unibox	12 530		20/300
<b>Cover strips</b>			
RAL 9016 wgrite, module cover strips for 1 module	1SL2857A00		50/1500
RAL 9016 wgrite, module cover strips for 4 modules	1SL2859A00		25/300
<b>Coupling element</b>			
Unibox coupling element	12556		10/100
<b>Spare doors</b>			
Cable-clip com for Unibox Series	12550		1/30

# Alpha Series

The details make the difference

6

Flexible frame allows mounting on uneven surfaces

Removable frames (complete frame and individual DIN-rails)

IP40 Wall-mounting consumer unit; 18 modules (17,5-18mm) per row; DIN-rail row spacing: 150mm

Takes trunking up to 260x65mm; Feed wire (25mm<sup>2</sup>) can be easily inserted



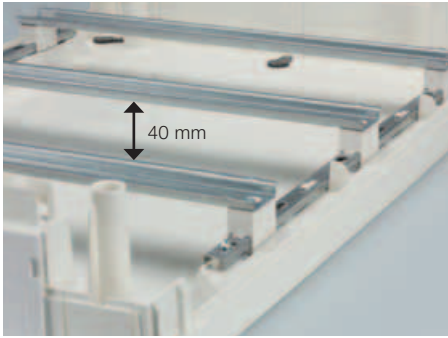

Plenty of wiring space in the Alpha Series: the distance between the DIN-rail and the back plate is 40mm.



Flexible and easy wiring: Removable complete DIN-rail frame to facilitate cabling and wiring. The DIN-rails can be also taken out individually. The distance of 150 mm between each DIN-rail allows more space for wiring.

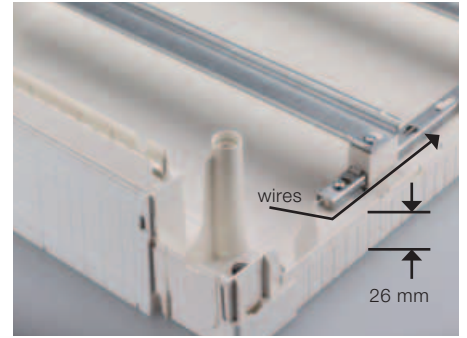

Easiness and flexibility: low sides of the Alpha consumer units for easy access; wires can be led around the frame. Flexible frame allows mounting on uneven surfaces.



Reversible door: left or right opening by flipping of cover. Lock can be inserted in door.



Door can be opened up onto the wall (210°).



Easy alignment thanks to slotted holes.



Sliding screw covers to ensure protection class II (double insulated).

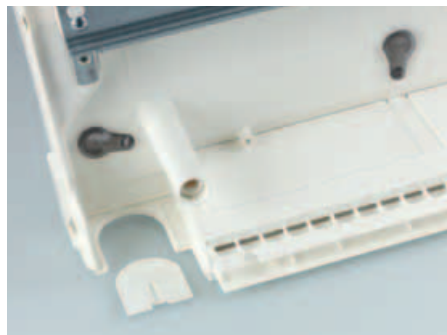

Possibility for inserting cable gland M25 on all four corners.

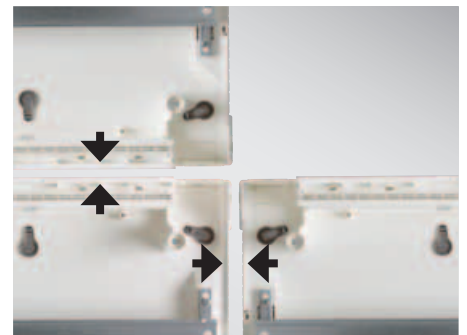

Alpha enclosures can be interconnected horizontally and vertically.

# Ordering Information

## Alpha Series



2CSC400030F0177

1-row



2CSC400030F0178

2-row



2CSC400030F0179

3-row



2CSC400030F0180

4-row

- Rated current  $I_n = 100A$ ; Protection degree IP41; Protection class II (double insulated); Shock resistance 2 Joules (IK level 07)
- In thermoplastic, self-extinguishing and resistant to abnormal heat and fire up to 750°C (GWT)
- Installation temperature from  $-5^{\circ}C \div +40^{\circ}C$
- Row Distance: 150mm
- Alpha Series are manufactured in compliance with IEC 60439 Standard
- Alpha consumer units are supplied complete with: Cover strip 13 modules; labelling sheet; labelling pictogrammes; PE terminal bars

Description	N° module [18 mm]	Dimensions HxWxD [mm]	Order code	Price
<b>1-row</b> ☐				
Alpha, wall-mounting, RAL 9010 white, with smoky brown door, with PE terminal bar 9 x 10 + 8 x 16 mm <sup>2</sup>	18	307x390x152	1SPE007711F0001	
<b>2-row</b> ☐				
Alpha, wall-mounting, RAL 9010 white, with smoky brown door, with PE terminal bar 9 x 10 + 8 x 16 mm <sup>2</sup>	36	457x390x152	1SPE007711F0002	
<b>3-row</b> ☐				
Alpha, wall-mounting, RAL 9010 white, with smoky brown door, with PE terminal bar 13 x 10 + 12 x 16 mm <sup>2</sup>	54	607x390x152	1SPE007711F0003	
<b>4-row</b> ☐				
Alpha, wall-mounting, RAL 9010 white, with smoky brown door, with PE terminal bar 13 x 10 + 12 x 16 mm <sup>2</sup>	72	757x390x152	1SPE007711F0004	

# Ordering Information

## Alpha Series - Accessories



2CSC400030F0181

Cover strip



2CSC400030F0182

Circuit identification label



2CSC400030F0183

Cable insert



2CSC400030F0184

PE terminal bar



2CSC400030F0185

Lock with unique key code

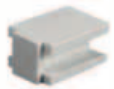

2CSC400030F0186

Coupler

Description	Order code	Price
Cover strip 18 modules, RAL 9010 white	1SPE007711F0007	
Circuit identification label	1SPE007711F0008	
Cable insert	1SPE007711F0009	
PE terminal bar 13x10+12x16 mm <sup>2</sup>	1SPE007711F0010	
Lock with random key code	1SPE007710F0420	
Lock with unique key code 134	1SPE007710F0425	
Coupler (for horizontal & vertical coupling)	1SPE007710F0710	



# AT/U Series

The details make the difference

Compact distribution boards AT/U series: for wall-mounting, flush-mounting and hollow-wall mounting (in connection with ZKV200P4)

Doors are assembled and disassembled without tools, and the door hinges can be adjusted steplessly

Integrated cable strain-relief, spacious wall mounting

The installed distribution panels can be removed for equipping and wiring

Wide range: with metal or transparent door; Range from 36 up to 240 modules (18 mm)





With its slightly inclined sides, the bright white cabinet and the attractive locking system, the compact distribution boards sets new standards in design.



All AT wall-mounting compact distribution boards are equipped with one integrated flush fitting membrane flange per panel width on top.

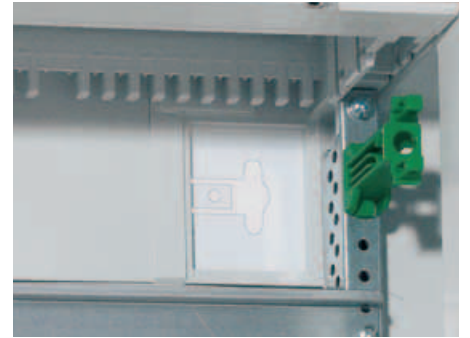

A further standard feature per panel width is the cable strain-relief at the top and the bottom, which considerably simplifies the installation for every wall-mounting and flush-mounting type.



All flush-mounting compact distribution boards can be installed in the hollow wall in just a few steps using the hollow wall set (accessory). No longer two separate cabinets need to be kept on stock - you only need one cabinet for two applications.

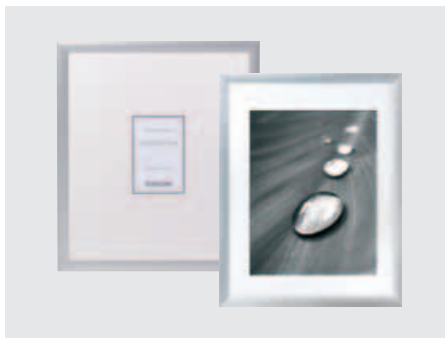

An alternative picture frame door is available for the U flush-mounting version. Control panels for commercial and industrial buildings are also available: they can be supplied to be finished and wired by the user, or can be printed and wired according to the user's requirements already in the factory.



Easy any flexible: AT and U Series offers a wide range for almost all applications: wall-mounting, flush-mounting, with metal, transparent or design door, with mounting plates or with DIN-rails and many more. And all with one single order number.

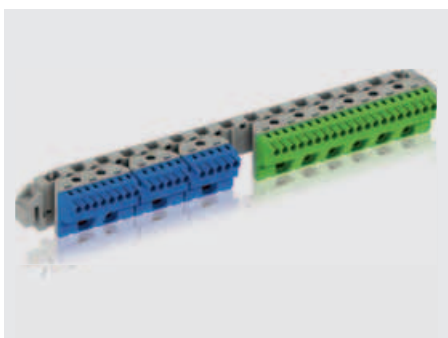

AT and U series allows with its user-friendly snap-in type N/PE quick busbars considerable time-saving.



Fast assembly of the sealable covers using 90° press and turn closures, which fit into all modular cabinets.



Prepared for all requirements: An earthing set for conversion to protection class I (earthed) is available as an accessory for AT and for U Series.

# N/PE Quick-terminals standardised, future-oriented and flexible

The new N/PE Quick-terminals from STRIEBEL & JOHN are designed for the things to come. Conforming to the current standard DIN VDE 0100 Part 410 and extremely flexible in terms of expandability, these N/PE Quick-terminals are unmatched for safe, efficient and future-oriented conductor connections.

As an electrician you no longer have to compromise. The new N/PE Quick-terminals from STRIEBEL & JOHN can simplify your work: Just choose the right terminal blocks and plug them in! The resulting installation is tidy and flexible. The colour coding ensures that you will find your way even with expansions.

## Product benefits

- Compliance with DIN VDE 0100 Part 410 (protection against electric shock)
- Flexible terminal system for several N power circuits: Screw connections: 2.5 to 25 mm<sup>2</sup>; spring terminals: 1.5 to 4 mm<sup>2</sup>.
- Optimal when using several residual current circuit breaker (RCDs)
- Combination of several Quick-terminals on one common quick carrier
- Ease of expansion using connecting bridges
- Precise assignment of the terminal blocks (clear colour coding: N = blue, PE = yellow-green)
- Easy labelling of the terminals (DIN VDE 0603 Part 1) using pre-printed, self-adhesive number strips
- Wide range of applications: can be used in the UK500 and A300 consumer unit series, in all compact distribution boards, and with all meter cabinets, wall-mounting and floor-standing cabinets
- The new terminal system replaces the N/PE Quick-busbars that were previously in use

6

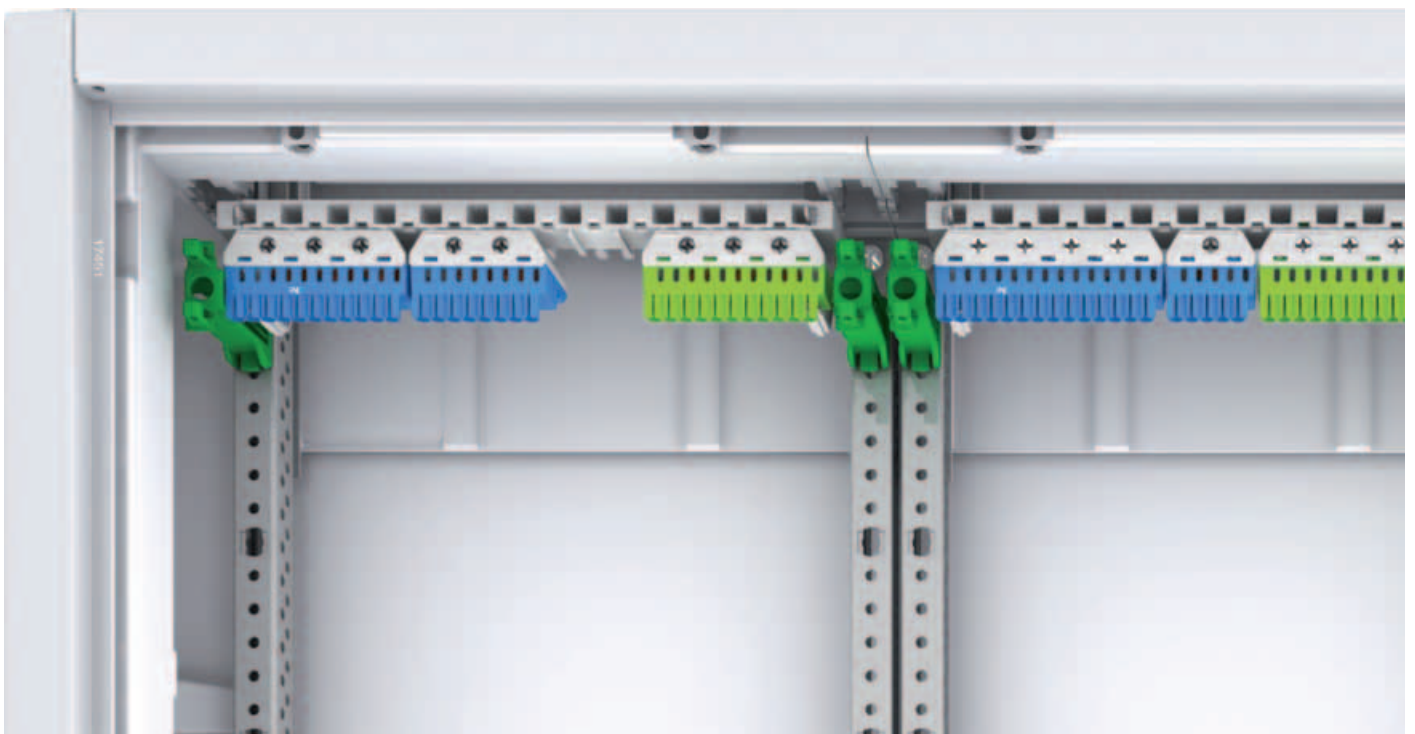

# N/PE Quick-terminals

## The complete range of products

### Clean and tidy work

Anyone would like their distribution board so tidy: all Quick-terminals are mounted next to each other on one carrier with standardised colour coding.

### Configure based on your needs

The modularity of the new series and the extensive range of products allow customising the new products to the needs based on real-world use. Various Quick-terminals can be combined on one quick carrier as necessary.

### Flexible by design

You need a larger N terminal? No problem. You can connect individual Quick-terminals with connecting bridges and remain in compliance with the technical requirements of IEC 60364-4-41 and DIN VDE 0100 Part 410 in an economic way.

The high flexibility of the new series is a crucial advantage here and in other solutions. The ability to combine terminal blocks with different numbers of terminals offers numerous possibilities.

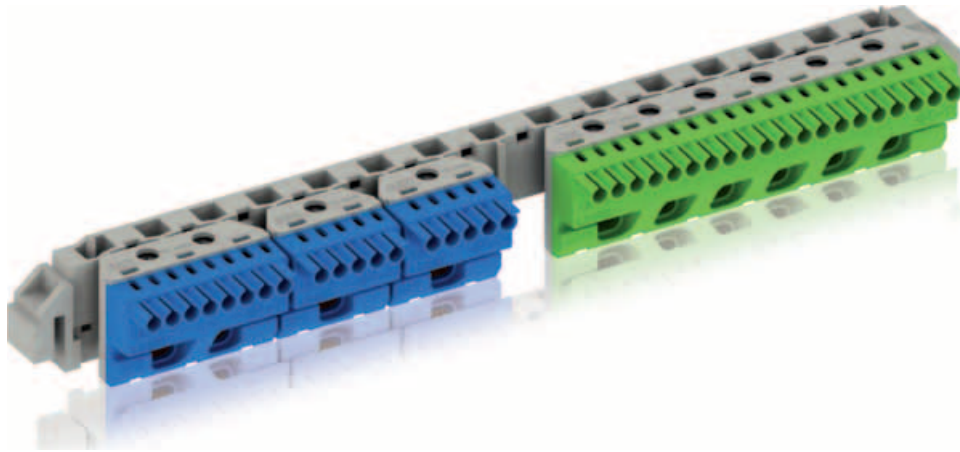

### N Quick-terminals

	1 x 25 mm <sup>2</sup> + 5 x 1.5 - 4 mm <sup>2</sup>
	2 x 25 mm <sup>2</sup> + 8 x 1.5 - 4 mm <sup>2</sup>
	3 x 25 mm <sup>2</sup> + 11 x 1.5 - 4 mm <sup>2</sup>
	4 x 25 mm <sup>2</sup> + 14 x 1.5 - 4 mm <sup>2</sup>
	5 x 25 mm <sup>2</sup> + 17 x 1.5 - 4 mm <sup>2</sup>
	6 x 25 mm <sup>2</sup> + 20 x 1.5 - 4 mm <sup>2</sup>
	0 x 25 mm <sup>2</sup> + 5 x 1.5 - 4 mm <sup>2</sup>

### PE Quick-terminals

	1 x 25 mm <sup>2</sup> + 5 x 1.5 - 4 mm <sup>2</sup>
	2 x 25 mm <sup>2</sup> + 8 x 1.5 - 4 mm <sup>2</sup>
	3 x 25 mm <sup>2</sup> + 11 x 1.5 - 4 mm <sup>2</sup>
	4 x 25 mm <sup>2</sup> + 14 x 1.5 - 4 mm <sup>2</sup>
	5 x 25 mm <sup>2</sup> + 17 x 1.5 - 4 mm <sup>2</sup>
	6 x 25 mm <sup>2</sup> + 20 x 1.5 - 4 mm <sup>2</sup>

# Compact distribution boards

## With panels and doors



2CSC400030D0202

Panels and doors

### Compact distribution boards with panels and doors

#### 125 mm or 150 mm DIN rail spacing

I<sub>n</sub> up to 125 A

DIN EN 60439-1 (VDE 0660-500)

Degree of protection IP43 (AT)

Degree of protection IP31 (U)

Protection class II, double insulated

Protection class I, earthed in connection with an earthing set (accessory)

The installed distribution board panels can be removed for equipping and wiring

The covers of U and AT compact distribution boards are made of polystyrene

Panels for DIN rail devices come with N/PE quick terminals

125 mm or 150 mm DIN rail spacing

Enclosures and doors made of sheet steel, 1 mm

Colour: white, RAL 9016

3 or more panels wide: double-wing doors

#### With new N/PE Quick-terminals for panels for rail mounting devices

#### Without N/PE Quick-terminals for panels with wiring space or mounting plates

Panels for terminals have DIN rails assembled insulated (without N/PE Quick terminals) (K)

Panels with mounting plate (without N/PE Quick-terminal) (M)

Hollow-wall-mounting set for flush-mounting versions (accessory)

With cable strain relief

With one membrane flange per panel width on top (AT)

With labelling system

Trim frame adjusted for uneven surfaces (U)

Cable entry covers (accessory)

# Compact distribution boards

## The new N/PE Quick-terminals



The new N/PE Quick-terminals

### Compact distribution boards, IP43 (AT), IP31(U) \*

$I_n$  up to 125 A

DIN EN 60439-1 (VDE 0660-500)

The installed distribution board panels can be removed for equipping and wiring

125 mm or 150 mm DIN rail spacing

Enclosures and doors made of sheet steel, 1 mm

Colour: white, RAL 9016

3 or more panels wide: Double-wing doors

**With new N/PE Quick-terminals for panels for rail mounting devices**

**Without N/PE Quick-terminals for panels with wiring space or mounting plates**

With cable strain relief

With one membrane flange per panel width on top (AT)

With labelling system

Trim frame adjusted for uneven surfaces (U)

\* In connection with earthing set

\*1 In connection with a hollow-wall set ZKV200P4

Article	Type	Equipment with new N/PE Quick-terminals Compact distribution boards*
N/PE quick carriers	ZK13	1 pc.
N Quick terminal	ZK82B	1 pc.
	ZK113B	1 pc.
PE Quick-terminal	ZK175G	1 pc.

\*Included in the scope of delivery for distribution board panels for rail mounting devices

# N/PE Quick-terminals Accessories

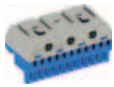

2CSC400030F0604

ZK113B



2CSC400030F0605

ZK50BT

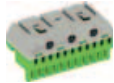

2CSC400030F0606

ZK113G



2CSC400030F0607

ZK10P10



2CSC400030F0608

ZK13



2CSC400030F0609

ZK15

Article	Number of terminals 1.5 - 4 mm <sup>2</sup>	Number of terminals 2.5 - 25 mm <sup>2</sup>	External dimensions H x W x D in mm	Pcs.	Type	Ord. no.	Price
<b>N Quick-terminals</b>							
For quick carriers	5	0	23 x 32 x 21	1	ZK50B	2CPX062750R9999	
	5	1	32 x 32 x 31	1	ZK51B	2CPX062751R9999	
	8	2	32 x 49 x 31	1	ZK82B	2CPX062752R9999	
	11	3	32 x 65 x 31	1	ZK113B	2CPX062753R9999	
	14	4	32 x 82 x 31	1	ZK144B	2CPX062754R9999	
	17	5	32 x 98 x 31	1	ZK175B	2CPX062755R9999	
	20	6	32 x 115 x 31	1	ZK206B	2CPX062756R9999	
<b>N Quick-terminal with adapter ZK15</b>							
For lateral assembly to the UK5... , A3... or for fastening to the DIN rail	5	0	28 x 39 x 25	1	ZK50BT	2CPX062745R9999	
<b>PE Quick-terminals</b>							
For quick carriers	5	1	32 x 32 x 31	1	ZK51G	2CPX062757R9999	
	8	2	32 x 49 x 31	1	ZK82G	2CPX062758R9999	
	11	3	32 x 65 x 31	1	ZK113G	2CPX062759R9999	
	14	4	32 x 82 x 31	1	ZK144G	2CPX062760R9999	
	17	5	32 x 98 x 31	1	ZK175G	2CPX062761R9999	
	20	6	32 x 115 x 31	1	ZK206G	2CPX062762R9999	
<b>Connecting bridges</b>							
For Quick-terminals				10	ZK10P10	2CPX062763R9999	
<b>Quick carriers</b>							
For consumer units AT/U Usable width for Quick-terminals 214 mm				1	ZK13	2CPX064982R9999	
<b>Adapter for ZK50B</b>							
Engaging the ZK50B N Quick-terminal in the adapter ZK15, leads to ZK50BT to be laterally fastened UK5... , A3 or to the DIN rail				1	ZK15	2CPX064984R9999	



# AT wall-mounting distribution boards

## With panels and sheet steel doors



2CSC400030F0300

AT31



2CSC400030F0301

AT42



2CSC400030F0302

AT42/2



2CSC400030F0303

AT53



2CSC400030F0304

AT54E

PW	GU	SU	External dimensions		Type	Ord. no.	Price
			H x W x D in mm				
<b>For rail mounting devices, 125 mm DIN rail spacing, with membran flanges</b>							
1	3	36	524 x 324 x 140		AT31	2CPX030099R9999	
	4	48	674 x 324 x 140		AT41	2CPX030121R9999	
	5	60	824 x 324 x 140		AT51	2CPX030124R9999	
	6	72	974 x 324 x 140		AT61	2CPX030130R9999	
2	2	48	374 x 574 x 140		AT22E	2CPX071740R9999	
	4	96	674 x 574 x 140		AT42	2CPX030122R9999	
	5	120	824 x 574 x 140		AT52	2CPX030125R9999	
	6	144	974 x 574 x 140		AT62	2CPX030131R9999	
2 (1/1)	7	168	1124 x 574 x 140		AT72	2CPX030134R9999	
	3	72	524 x 574 x 140		AT32	2CPX030120R9999	
	4	96	674 x 574 x 140		AT42/2	2CPX030138R9999	
3 (2/1)	5	120	824 x 574 x 140		AT52/2	2CPX030139R9999	
	4	144	674 x 824 x 140		AT43	2CPX030123R9999	
	5	180	824 x 824 x 140		AT53	2CPX030127R9999	
4 (2/2)	6	216	974 x 824 x 140		AT63E	2CPX071751R9999	
	5	240	824 x 1074 x 140		AT54E	2CPX071748R9999	

> For cable entry cover accessories, see page 2/16

# AT wall-mounting distribution boards

## With panels and sheet steel doors



2CSC400030F0306

AT41R3



2CSC400030F0306

AT42R3



2CSC400030F0307

AT53R4

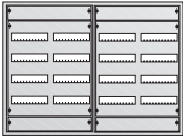

2CSC400030F0308

AT54R4



2CSC400030F0309

AT41R3IE



2CSC400030F0310

AT42R3IE



2CSC400030F0311

AT53R4IE



2CSC400030F0312

AT54R4IE

PW	GU	SU	External dimensions		Type	Ord. no.	Price
			H x W x D in mm				
<b>For rail mounting devices, 150 mm DIN rail spacing, with membran flanges</b>							
1	3	36	674 x 324 x 140		AT41R3	2CPX071681R9999	
	4	48	824 x 324 x 140		AT51R4	2CPX071684R9999	
	5	60	974 x 324 x 140		AT61R5	2CPX071688R9999	
2	2	48	524 x 574 x 140		AT32R2	2CPX071680R9999	
	3	72	674 x 574 x 140		AT42R3	2CPX071682R9999	
	4	96	824 x 574 x 140		AT52R4	2CPX071685R9999	
3 (2/1)	5	120	974 x 574 x 140		AT62R5	2CPX071689R9999	
	6	144	1124 x 574 x 140		AT72R6	2CPX071691R9999	
	3	108	674 x 824 x 140		AT43R3	2CPX071683R9999	
4 (2/2)	4	144	824 x 824 x 140		AT53R4	2CPX071686R9999	
	5	180	974 x 824 x 140		AT63R5	2CPX071690R9999	
	6	216	1124 x 824 x 140		AT73R6	2CPX071692R9999	
4 (2/2)	4	192	824 x 1074 x 140		AT54R4	2CPX071687R9999	
<b>For rail mounting devices, 150 mm DIN rail spacing, with sheet steel flange</b>							
1	3	36	674 x 324 x 140		AT41R3IE	2CPX071681R9999	
	4	48	824 x 324 x 140		AT51R4IE	2CPX071684R9999	
	5	60	974 x 324 x 140		AT61R5	2CPX071688R9999	
2	2	48	524 x 574 x 140		AT32R2IE	2CPX071680R9999	
	3	72	674 x 574 x 140		AT42R3IE	2CPX071682R9999	
	4	96	824 x 574 x 140		AT52R4IE	2CPX071685R9999	
3 (2/1)	5	120	974 x 574 x 140		AT62R5IE	2CPX071689R9999	
	6	144	1124 x 574 x 140		AT72R6IE	2CPX071691R9999	
	3	108	674 x 824 x 140		AT43R3IE	2CPX071683R9999	
4 (2/2)	4	144	824 x 824 x 140		AT53R4IE	2CPX071686R9999	
	5	180	974 x 824 x 140		AT63R5IE	2CPX071690R9999	
	6	216	1124 x 824 x 140		AT73R6IE	2CPX071692R9999	
4 (2/2)	4	192	824 x 1074 x 140		AT54R4IE	2CPX071687R9999	

> For cable entry cover accessories, see page 2/16

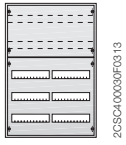

AT52K

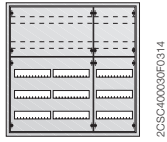

AT53K

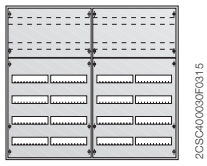

AT64K

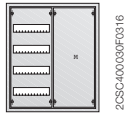

AT42M

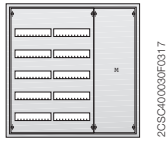

AT53M

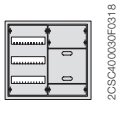

AT32EP

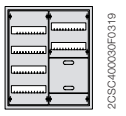

AT42EP



AT52EP

PW	GU	SU	External dimensions		Type	Ord. no.	Price
			H x W x D in mm				
<b>For rail mounting devices and terminals, DIN rail spacing 125 mm</b>							
2	5	120	824 x 574 x 140		AT52K	2CPX030126R9999	
	6	144	974 x 574 x 140		AT62K	2CPX030132R9999	
	7	168	1124 x 574 x 140		AT72K	2CPX030135R9999	
3 (2/1)	5	180	824 x 824 x 140		AT53K	2CPX030128R9999	
	6	216	974 x 824 x 140		AT63K	2CPX030133R9999	
	7	252	1124 x 824 x 140		AT73K	2CPX030136R9999	
4 (2/2)	5	240	824 x 1074 x 140		AT54K	2CPX030129R9999	
	6	288	974 x 1074 x 140		AT64K	2CPX030137R9999	
<b>For rail mounting devices and mounting plates, DIN rail spacing 125 mm</b>							
2 (1/1)	4	96	674 x 574 x 140		AT42M	2CPX030148R9999	
3 (2/1)	5	180	824 x 824 x 140		AT53M	2CPX030149R9999	
<b>For rail mounting devices and meter plates, DIN rail spacing 125 mm</b>							
2 (1/1)	3	72	524 x 574 x 140		AT32EP	2CPX071760R9999	
2 (1/1)	4	96	674 x 574 x 140		AT42EP	2CPX071761R9999	
2 (1/1)	5	120	824 x 574 x 140		AT52EP	2CPX071762R9999	

> For cable entry cover accessories, see page 2/16

# AT wall-mounting distribution boards

## With panels and transparent doors

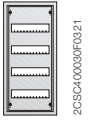

2CSC400030F0321

AT41TE



2CSC400030F0322

AT32TE

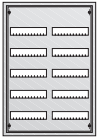

2CSC400030F0323

AT52TE

6



2CSC400030F0324

AT41TR3



2CSC400030F0325

AT52TR4



2CSC400030F0326

AT63TR5



2CSC400030F0327

AT54TR4

PW	GU	SU	External dimensions		Type	Ord. no.	Price
			H x W x D in mm				
<b>For rail mounting devices, 125 mm DIN rail spacing</b>							
1	4	48	674 x 324 x 140		AT41TE	2CPX071585R9999	
	5	60	824 x 324 x 140		AT51TE	2CPX071587R9999	
	6	72	974 x 324 x 140		AT61TE	2CPX071589R9999	
2 (1/1)	3	72	524 x 574 x 140		AT32TE	2CPX071584R9999	
2	4	96	674 x 574 x 140		AT42TE	2CPX071586R9999	
	5	120	824 x 574 x 140		AT52TE	2CPX071588R9999	
	6	144	974 x 574 x 140		AT62TE	2CPX071590R9999	
<b>For rail mounting devices, 150 mm DIN rail spacing</b>							
1	3	36	674 x 324 x 140		AT41TR3	2CPX071695R9999	
	4	48	824 x 324 x 140		AT51TR4	2CPX071698R9999	
	5	60	974 x 324 x 140		AT61TR5	2CPX071702R9999	
2	2	48	524 x 574 x 140		AT32TR2	2CPX071694R9999	
	3	72	674 x 574 x 140		AT42TR3	2CPX071696R9999	
	4	96	824 x 574 x 140		AT52TR4	2CPX071699R9999	
	5	120	974 x 574 x 140		AT62TR5	2CPX071703R9999	
	6	144	1124 x 574 x 140		AT72TR6	2CPX071705R9999	
	3 (2/1)	3	108	674 x 824 x 140		AT43TR3	2CPX071697R9999
3 (2/1)	4	144	824 x 824 x 140		AT53TR4	2CPX071700R9999	
	5	180	974 x 824 x 140		AT63TR5	2CPX071704R9999	
	6	216	1124 x 824 x 140		AT73TR6	2CPX071706R9999	
4 (2/2)	4	192	82 x 1074 x 140		AT54TR4	2CPX071701R9999	

> For cable entry cover accessories, see page 2/16

# AT wall-mounting distribution boards

## Accessories cable entry covers

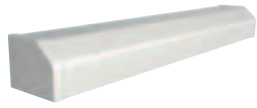

KB19

2CSC400030F0328

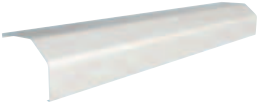

KB219

2CSC400030F0329



KBS9

2CSC400030F0330



KBW1

2CSC400030F0331

Article	Type	Ord. no.	Price
<b>Cable entry covers</b>			
With end plates and mounting brackets			
colour RAL 9016, adjusted to the colour of the cabinets			
Panel width 1, width = 300 mm	KB19	2CPX044049R9999	
Panel width 2, width = 550 mm	KB29	2CPX044050R9999	
Panel width 3, width = 800 mm	KB39	2CPX044051R9999	
Panel width 4, width = 1050 mm	KB49	2CPX044052R9999	
<b>Profile</b>			
Colour RAL 9016, width 2000 mm	KB219	2CPX044055R9999	
<b>End plate left/right</b>			
Colour RAL 9016	KBS9	2CPX044057R9999	
<b>Mounting brackets</b>			
	KBW1	2CPX044058R9999	

# U flush-mounting compact distribution boards

## With panels and sheet steel doors

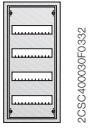

2CSC400030F0332

U41



2CSC400030F0333

U52



2CSC400030F0334

U42/2



2CSC400030F0335

U53

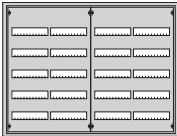

2CSC400030F0336

U54E



2CSC400030F0337

U41R3



2CSC400030F0338

U42R3



2CSC400030F0339

U53R4



2CSC400030F0340

U54R4

PW	GU	SU	Wall cut out dimensions	Trim frame dimensions	Type	Ord. no.	Price
			H x W x D in mm	H x W x D in mm			
<b>For rail mounting devices, 125 mm DIN rail spacing</b>							
1	4	48	684 x 310 x 120	694 x 354 x 27	U41	2CPX030101R9999	
	5	60	834 x 310 x 120	844 x 354 x 27	U51	2CPX030104R9999	
	6	72	984 x 310 x 120	994 x 354 x 27	U61	2CPX030110R9999	
2	4	96	684 x 560 x 120	694 x 604 x 27	U42	2CPX030102R9999	
	5	120	834 x 560 x 120	844 x 604 x 27	U52	2CPX030105R9999	
	6	144	984 x 560 x 120	994 x 604 x 27	U62	2CPX030111R9999	
	7	168	1134 x 560 x 120	1144 x 604 x 27	U72	2CPX030114R9999	
2 (1/1)	3	72	534 x 560 x 120	544 x 604 x 27	U32	2CPX030100R9999	
	4	96	684 x 560 x 120	694 x 604 x 27	U42/2	2CPX030118R9999	
	5	120	834 x 560 x 120	844 x 604 x 27	U52/2	2CPX030119R9999	
3 (2/1)	4	144	684 x 810 x 120	694 x 854 x 27	U43	2CPX030103R9999	
	5	180	834 x 810 x 120	844 x 854 x 27	U53	2CPX030107R9999	
	6	216	984 x 810 x 120	994 x 854 x 27	U63E	2CPX071787R9999	
4 (2/2)	5	240	834 x 1060 x 120	844 x 1104 x 27	U54E	2CPX071784R9999	
<b>For rail mounting devices, 150 mm DIN rail spacing</b>							
1	3	36	684 x 310 x 120	694 x 354 x 27	U41R3	2CPX071708R9999	
	4	48	834 x 310 x 120	844 x 354 x 27	U51R4	2CPX071711R9999	
	5	60	984 x 310 x 120	994 x 354 x 27	U61R5	2CPX071715R9999	
2	2	48	534 x 560 x 120	544 x 604 x 27	U32R2	2CPX071707R9999	
	3	72	684 x 560 x 120	694 x 604 x 27	U42R3	2CPX071709R9999	
	4	96	834 x 560 x 120	844 x 604 x 27	U52R4	2CPX071712R9999	
	5	120	984 x 560 x 120	994 x 604 x 27	U62R5	2CPX071716R9999	
	6	144	1134 x 560 x 120	1144 x 604 x 27	U72R6	2CPX071718R9999	
3 (2/1)	3	108	684 x 810 x 120	694 x 854 x 27	U43R3	2CPX071710R9999	
	4	144	834 x 810 x 120	844 x 854 x 27	U53R4	2CPX071713R9999	
	5	180	984 x 810 x 120	994 x 854 x 27	U63R5	2CPX071717R9999	
4 (2/2)	6	216	1134 x 810 x 120	1144 x 854 x 27	U73R6	2CPX071719R9999	
	4	192	834 x 1060 x 120	844 x 1104 x 27	U54R4	2CPX071714R9999	

# U flush-mounting compact distribution boards

## With panels and sheet steel doors

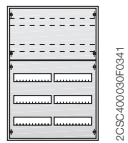

U52K

2CSC400030F0341

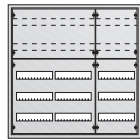

U53K

2CSC400030F0342

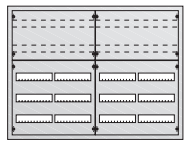

U54K

2CSC400030F0343



U42M

2CSC400030F0344



U53M

2CSC400030F0345



U51EP

2CSC400030F0346



U32EP

2CSC400030F0347



U42EP

2CSC400030F0348



U52EP

2CSC400030F0349

PW	GU	SU	Wall cut out dimensions		Trim frame dimensions		Type	Ord. no.	Price
			H x W x D in mm		H x W x D in mm				
<b>For rail mounting devices and terminals, DIN rail spacing 125 mm</b>									
2	5	120	834 x 560 x 120		844 x 604 x 27		U52K	2CPX030106R9999	
	6	144	984 x 560 x 120		994 x 604 x 27		U62K	2CPX030112R9999	
	7	168	1134 x 560 x 120		1144 x 604 x 27		U72K	2CPX030115R9999	
3 (2/1)	5	180	834 x 810 x 120		844 x 854 x 27		U53K	2CPX030108R9999	
	6	216	984 x 810 x 120		994 x 854 x 27		U63K	2CPX030113R9999	
	7	252	1134 x 810 x 120		1144 x 854 x 27		U73K	2CPX030116R9999	
4 (2/2)	5	240	834 x 1060 x 120		844 x 1104 x 27		U54K	2CPX030109R9999	
	6	288	984 x 1060 x 120		994 x 1104 x 27		U64K	2CPX030117R9999	
<b>For rail mounting devices and mounting plates, 125 mm DIN rail spacing</b>									
2 (1/1)	4	96	684 x 560 x 120		694 x 604 x 27		U42M	2CPX030146R9999	
3 (2/1)	5	180	834 x 810 x 120		844 x 854 x 27		U53M	2CPX030147R9999	
<b>For rail mounting devices and meter plates, DIN rail spacing 125 mm</b>									
1	5	60	834 x 310 x 120		844 x 354 x 27		U51EP	2CPX071564R9999	
2 (1/1)	3	72	534 x 560 x 120		544 x 604 x 27		U32EP	2CPX071560R9999	
2 (1/1)	4	96	684 x 560 x 120		694 x 604 x 27		U42EP	2CPX071561R9999	
2 (1/1)	5	120	834 x 560 x 120		844 x 604 x 27		U52EP	2CPX071562R9999	



# U flush-mounting compact distribution boards

## With panels and transparent doors

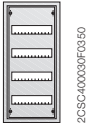

2CSC400030F03E0

U41TE



2CSC400030F03E1

U32TE



2CSC400030F03E2

U42TE

6

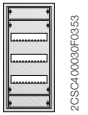

2CSC400030F03E3

U41TR3

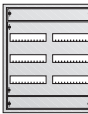

2CSC400030F03E4

U42TR3



2CSC400030F03E5

AT53TR4

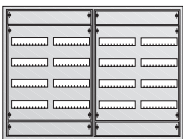

2CSC400030F03E6

U54TR4

PW	GU	SU	Wall cut out dimensions	Trim frame dimensions	Type	Ord. no.	Price
			H x W x D in mm	H x W x D in mm			
<b>For rail mounting devices, 125 mm DIN rail spacing</b>							
1	4	48	684 x 310 x 120	694 x 354 x 27	U41TE	2CPX071592R9999	
	5	60	834 x 310 x 120	844 x 354 x 27	U51TE	2CPX071594R9999	
	6	72	984 x 310 x 120	994 x 354 x 27	U61TE	2CPX071596R9999	
2 (1/1)	3	72	534 x 560 x 120	544 x 604 x 27	U32TE	2CPX071591R9999	
2	4	96	684 x 560 x 120	694 x 604 x 27	U42TE	2CPX071593R9999	
	5	120	834 x 560 x 120	844 x 604 x 27	U52TE	2CPX071595R9999	
	6	144	984 x 560 x 120	994 x 604 x 27	U62TE	2CPX071597R9999	
<b>For rail mounting devices, 150 mm DIN rail spacing</b>							
1	3	36	684 x 310 x 120	694 x 354 x 27	U41TR3	2CPX071722R9999	
	4	48	834 x 310 x 120	844 x 354 x 27	U51TR4	2CPX071725R9999	
	5	60	984 x 310 x 120	994 x 354 x 27	U61TR5	2CPX071729R9999	
2	2	48	534 x 560 x 120	544 x 604 x 27	U32TR2	2CPX071721R9999	
	3	72	684 x 560 x 120	694 x 604 x 27	U42TR3	2CPX071723R9999	
	4	96	834 x 560 x 120	844 x 604 x 27	U52TR4	2CPX071726R9999	
	5	120	984 x 560 x 120	994 x 604 x 27	U62TR5	2CPX071730R9999	
	6	144	1134 x 560 x 120	1144 x 604 x 27	U72TR6	2CPX071733R9999	
	3 (2/1)	3	108	684 x 810 x 120	694 x 854 x 27	U43TR3	2CPX071724R9999
3 (2/1)	4	144	834 x 810 x 120	844 x 854 x 27	U53TR4	2CPX071727R9999	
	5	180	984 x 810 x 120	994 x 854 x 27	U63TR5	2CPX071731R9999	
	6	216	1134 x 810 x 120	1144 x 854 x 27	U73TR6	2CPX071734R9999	
	4 (2/2)	4	192	834 x 1060 x 120	844 x 1104 x 27	U54TR4	2CPX071728R9999

# U flush-mounting compact distribution boards

## With panels and picture frame doors



2CSC400030F0657

U42D



2CSC400030F0658

U42FPT

PW	GU	SU	Wall cut out dimensions	Trim frame dimensions	Type	Ord. no.	Price
			H x W x D in mm	H x W x D in mm			
<b>With picture frame door, aluminium anodised, DIN rail spacing 125 mm</b>							
2	4	96	684 x 560 x 120	716 x 625 x 25	U42D	2CPX038152R9999	
<b>With control panel, unprinted and not wired, distribution board panel without cover and N/PE rail</b>							
2	4	96	684 x 560 x 120	716 x 625 x 25	U42FPT	2CPX038151R9999	

Example picture frame door with decoration picture (delivery without picture)



Example control panel with layout and control lights (delivery unprinted/not wired)



# Ordering Information

## AT/U Series - Accessories

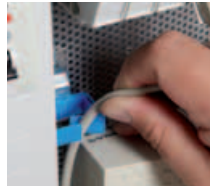

- Media panels with perforated sheet steel mounting plate without cover
- With fitted DIN rail
- Wire holders supplied
- Quick mounting of devices without drilling

6

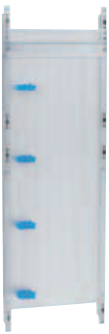

2CSC400030F0359



2CSC400030F0360

ZE225



2CSC400030F0361

ZX29



2CSC400030F0362

ED44P10



2CSC400030F0363

ED57P10



2CSC400030F0364

ZX287P10

Article	Pcs.	Type	Ord. no.	Price
<b>Media panel with perforated sheet steel mounting plate</b>				
Overall height 4 GU	1	1MM0A	2CPX030987R9999	
Overall height 5 GU	1	1MM1A	2CPX030988R9999	
Overall height 6 GU	1	1MM2A	2CPX030989R9999	
<b>Double socket with Euro plug insert</b>				
For supplying 230 V power to power supplies	1	ZE225	2CPX061177R9999	
<b>Mounting cross member</b>				
For double socket (ZE225)	1	ZX29	2CPX061178R9999	
<b>Wire holder</b>				
28.5 mm	10	ED44P10	2CPX062335R9999	
<b>Adapter</b>				
For assembling ED44P10 wire holders on the perforated sheet steel mounting plate	10	ED57P10	2CPX061179R9999	
<b>Screws</b>				
M4 x 14 thread rolling for the perforated sheet steel mounting plate	10	ZX287P10	2CPX061180R9999	



ZB113



ZB111



ZX456



ZX440



ZH800



ZH220



ZH130



ZH132



ZH134



ZH137

Article	Pcs.	Type	Ord. no.	Price
<b>Standard closure</b>				
Included in the scope of delivery	1	ZB113	2CPX038478R9999	
<b>Closure with lock</b>				
With 2 keys	1	ZB111	2CPX038479R9999	
<b>Espagnolette closure</b>				
In combination with standard closure ZB113* (earthing part!) or closure with lock ZB111				
Overall height 4 GU	1	ZX456	2CPX039586R9999	
Overall height 5 GU	1	ZX457	2CPX039587R9999	
Overall height 6 GU	1	ZX458	2CPX039588R9999	
Overall height 7 GU	1	ZX459	2CPX039589R9999	
<b>Espagnolette closure</b>				
In combination with ZH203, ZH220, ZH221, ZH222, ZH227, ZH228				
Overall height 4 GU	1	ZX440	2CPX039570R9999	
Overall height 5 GU	1	ZX441	2CPX039571R9999	
Overall height 6 GU	1	ZX442	2CPX039572R9999	
Overall height 7 GU	1	ZX443	2CPX039573R9999	
<b>Installation set*</b>				
Of different closure systems in combination with ZH220/ZH221/ZH222	1	ZH800	2CPX038544R9999	
<b>Latch plate</b>				
Double bit operating pin, 3 mm standard and 5 mm (ZH800 must be ordered separately)	1	ZH220	2CPX045700R9999	
For triangular or square operating pins and for Daimler-Benz insert (ZH800 must be ordered separately)	1	ZH221	2CPX045701R9999	
For T-handle or latch handle (ZH800 must be ordered separately)	1	ZH222	2CPX045702R9999	
<b>Operating pin</b>				
Double-bit 3 mm	1	ZH130	2CPX060490R9999	
Double-bit 5 mm	1	ZH131	2CPX060491R9999	
Triangular 7 mm	1	ZH132	2CPX060492R9999	
Triangular 8 mm	1	ZH133	2CPX060493R9999	
Square 6 mm	1	ZH134	2CPX060494R9999	
Square 7 mm	1	ZH135	2CPX060495R9999	
Square 8 mm	1	ZH136	2CPX060496R9999	
Daimler-Benz insert	1	ZH137	2CPX060497R9999	

\* Leave not less than 2 SU for DIN rail devices behind the closure

# Compact distribution boards

## Accessories



ZH157

2CSC400030F0375



ZH91

2CSC400030F0376



ZH138

2CSC400030F0377



ZH139

2CSC400030F0378



ZH140

2CSC400030F0379



ZH141

2CSC400030F0380



ZH228

2CSC400030F0381



ZH227

2CSC400030F0382



ZH203

2CSC400030F0383



ZH142

2CSC400030F0384

Article	Pcs.	Type	Ord. no.	Price
<b>Operating keys</b>				
Triangular 7 mm	1	ZH157	2CPX060657R9999	
Triangular 8 mm	1	ZH158	2CPX060658R9999	
Double-bit 3 mm	1	ZH160	2CPX060660R9999	
Double-bit 5 mm	1	ZH161	2CPX060661R9999	
Square 6 mm	1	ZH162	2CPX060662R9999	
Square 7 mm	1	ZH163	2CPX060663R9999	
Square 8 mm	1	ZH164	2CPX060664R9999	
Daimler-Benz insert	1	ZH165	2CPX060665R9999	
<b>Universal key</b>				
Double bit 3 and 5 mm	1	ZH91	2CPX066091R9999	
Triangular 8 mm				
Square 6 and 8 mm				
<b>T-handle*</b>				
Without lock	1	ZH138	2CPX060498R9999	
With lock	1	ZH139	2CPX060498R9999	
<b>Latch handle*</b>				
Without lock	1	ZH140	2CPX060500R9999	
With lock	1	ZH141	2CPX060501R9999	
<b>Swivel handle with lead sealable cap*</b>				
For semi-cylinder 40 mm (30/10)	1	ZH228	2CPX045709R9999	
<b>Swivel handle with lead sealable cap*</b>				
With cabinet handle Berlin	1	ZH227	2CPX045708R9999	
<b>Swivel handle with lead sealable cap*</b>				
With closure E0 12	1	ZH203	2CPX045707R9999	
<b>Dummy insert</b>				
Instead of a semi-cylinder for the swivel handle ZH228	1	ZH142	2CPX060502R9999	

\* Leave not less than 2 SU for DIN rail devices behind the closure

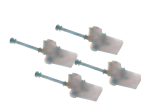

ZKV200P4

2CSC4000309F0385



ZE11

2CSC4000309F0386



ZE12

2CSC4000309F0387



ZB43

2CSC4000309F0388



ZB40

2CSC4000309F0389



ZB101

2CSC4000309F0390



ZX69

2CSC4000309F0391



ZA1P5

2CSC4000309F0392



ZA6

2CSC4000309F0393



ZA5

2CSC4000309F0394



ZX139LR

2CSC4000309F0395

Article	Pcs.	Type	Ord. no.	Price
<b>Hollow-wall-mounting set</b> For retrofitting flush-mounted distribution boards Wall thickness: min. 14 mm, max. 58 mm	1	ZB19	2CPX038187R9999	
<b>Earthing set for wall-mounting compact distribution boards</b> For conversion into protection class 1	1	ZE11	2CPX038143R9999	
<b>Earthing set for flush-mounting compact distribution boards</b> For conversion into protection class 1	1	ZE12	2CPX038144R9999	
<b>Membrane flange</b> For inserting the cable from below	1	ZB43	2CPX038183R9999	
<b>Nipple Flange</b>	1	ZB40	2CPX038195R9999	
<b>Closing Flange</b>	1	ZB101	2CPX038181R9999	
<b>Flange for conduits (bottom)</b>	1	ZB107E	2CPX071211R9999	
<b>Flange for conduits (top)</b>	1	ZB108E	2CPX071212R9999	
<b>Vertical partitions</b> Between distribution board panels, not arc-resistant				
Overall height 3 GU	1	ZX69	2CPX039069R9999	
Overall height 4 GU	1	ZX70	2CPX039070R9999	
Overall height 5 GU	1	ZX71	2CPX039071R9999	
Overall height 6 GU	1	ZX72	2CPX039072R9999	
Overall height 7 GU	1	ZX73	2CPX039073R9999	
<b>Slot cover</b> Colour RAL 7035 For 12 space units, break-off type	5 50	ZA1P5 ZA1P50	2CPX062384R9999 2CPX062378R9999	
<b>Document holder DIN A4</b> Self-adhesive with transparent sleeve	1 10	ZA6 ZA6P10	2CPX038227R9999 2CPX062380R9999	
Self-adhesive with transparent sleeve and reinforced back	10	ZA61P10	2CPX062375R9999	
<b>Document holder DIN A4</b> Self-adhesive	1 10	ZA13 ZA13P10	2CPX038233R9999 2CPX062381R9999	
<b>Document holder DIN A5</b> Self-adhesive	1 10	ZA5 ZA5P10	2CPX038228R9999 2CPX062382R9999	
<b>Door hinge (plastic)</b>	2	ZX139LR	2CPX039139R9999	

# Compact distribution boards

## Accessories

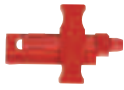

2CSC400030F0396

ZX464



2CSC400030F0397

ZX374



2CSC400030F0388



2CSC400030F0389

ZH411

ZH412



2CSC400030F0400



2CSC400030F0401

ZH425

ZH428

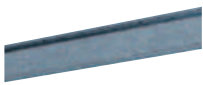

2CSC400030F0402

ZX371



2CSC400030F0403

ZK90P2

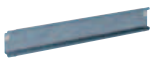

2CSC400030F0404

ZX21



2CSC400030F0384

ZB32P20

Article	Pcs.	Type	Ord. no.	Price
<b>Door bolt for double-wing doors</b>				
For cabinets with three or more panel widths	1	ZX464	2CPX039596R9999	
<b>Cross member</b>				
For fuse switch disconnectors size 00, 1 panel wide	1	ZX374	2CPX068079R9999	
<b>Fuse switch disconnecter</b>				
Size 00 160 A (without trim cover)				
With M8 screw connection	1	ZH411	2CPX062947R9999	
With clip terminal up to 50 mm <sup>2</sup>	1	ZH412	2CPX062948R9999	
<b>Trim cover</b>				
For fuse switch disconnecter size 00				
Single trim cover	1	ZH425	2CPX062952R9999	
Double trim cover	1	ZH426	2CPX062953R9999	
Blank cover	1	ZH428	2CPX062955R9999	
<b>DIN rail for terminals</b>				
35 x 7.5 mm				
For recessed mounting in conjunction with mounting bracket ZX372P2 and insulator ZK90P2				
1 panel wide	1	ZX371	2CPX068076R9999	
2 panels wide	1	ZX389	2CPX068190R9999	
<b>Insulator for DIN rails</b>				
35 x 7.5 mm including fastening material	2	ZK90P2	2CPX062426R9999	
<b>DIN rail</b>				
35 x 7.5 mm				
1 panel wide	1	ZX21	2CPX039021R9999	
2 panels wide	1	ZX22	2CPX039022R9999	
<b>Fastening screws for DIN rails</b>				
Slotted/hexalobular socket pan head thread rolling screw T25 –	20	ZB32P20	2CPX062651R9999	
Slotted/hexalobular socket pan head thread rolling screw T25 –	500	ZB32P500	2CPX062652R9999	





2CSC400030F0406

ED137P4



2CSC400030F0407

ED50P12

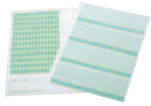

2CSC400030F0408

ZKV201

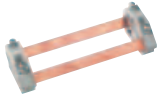

2CSC400030F0409

ZK300

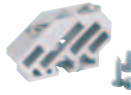

2CSC400030F0410

ZX518



2CSC400030F0411

ZX400



2CSC400030F0412

ZB19



2CSC400030F0413

ZA122



2CSC400030F0414

ZA20



2CSC400030F0415

ZA120

Article	Pcs.	Type	Ord. no.	Price
<b>Cover holder 45 mm high</b>	4	ED137P4	2CPX062600R9999	
For fastening on the EDF profile	40	ED137P40	2CPX062601R9999	
For DIN rails 35 x 7.5 mm, use only these cover holders				
<b>Press-and-turn fixing</b>				
To cover distribution board panels	12	ED50P12	2CPX062337R9999	
<b>Labelling system</b>				
Self-adhesive, for AT and U distribution boards	1	ZKV201	2CPX038148R9999	
<b>Busbar system for N/PE</b>				
Cu 12 x 5 mm, max. connection 95 mm <sup>2</sup>				
1 panel wide	1	ZK300	2CPX038551R9999	
2 panels wide	1	ZK301	2CPX038552R9999	
<b>N/PE busbar holder</b>				
For copper busbars 12 x 5 mm, 20 x 5 mm, 30 x 5 mm	1	ZX518	2CPX067805R9999	
	10	ZX518P10	2CPX062551R9999	
<b>Copper busbars</b>				
12 x 5 mm = 250 A				
1 m long		ZX400	2CPX061400R9999	
2 m long		ZX401	2CPX061401R9999	
3 m long		ZX402	2CPX061402R9999	
4 m long		ZX350	2CPX061350R9999	
<b>Cover profile</b>				
For copper busbars 12 x 5 and 12 x 10 mm, length 1 m		ZB19	2CPX038187R9999	
To clip on busbars				
<b>Cleaner</b>				
For distribution board panel covers	1	ZA122	2CPX038293R9999	
Spray dispenser, 500 ml				
<b>Spray paint can</b>				
Colour RAL 9016, 150 ml	1	ZA20	2CPX038229R9999	
<b>Touch-up applicator</b>				
Colour RAL 9016, 12 ml	1	ZA120	2CPX039043R9999	

# IP65 Europa Series

## The details make the difference

Available in two versions: with opaque door and with transparent, smoky door; Range from 4 up to 54 modules.

Versions with sealable spring closure and with key lock.

Designed to use the UNIFIX L rapid cabling system

The snap-on, extractable DIN rail frame simplifies and speeds up bench cabling operations.

Cover with special hinges: possibility to attach cover on the door (on the right or the left); door plus cover with 140° opening





Perfectly symmetrical consumer units with the possibility of attaching the door hinge onto the front (by means of the special articulated screws supplied) on the right or left with 140° opening.



Europa IP65 models with 8 modules and more fitted with one rigid and one bi-material flange to facilitate input of conduits and cables.

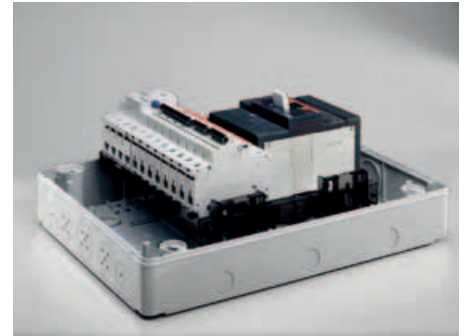

Extractable DIN-rail frame to facilitate bench cabling. It can also be dismantled (and snapped on to reassemble it) to make it easier and faster to cable the individual wires

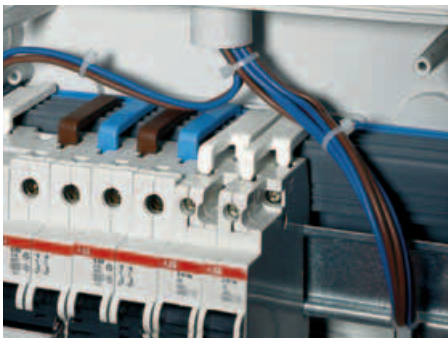

Europa IP65 with 8 modules and more have been designed to use the UNIFIX L rapid cabling system.



When fixing the unit to the wall from the inside, the special hole caps ensure double insulation is maintained.



Using the brackets it is easy to fix the Europa IP65 consumer unit in any environment.



The frame that can be fitted onto the consumer unit makes semi-flush mounting possible, guaranteeing an attractive finish.

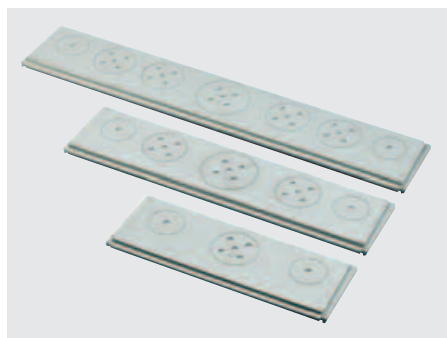

The two-component flange for direct wiring with conduits and cables: thanks to the two-component technology (molding of two materials at the same time) the flange obtains rigid plastic and softer plastic (rubber) and a rubber coating.



The elastic properties of the rubber of the two-component flange ensure the complete tightness to the plastic of the conduit or of the cable case. By using a simple screwdriver and a scissor you get the wiring by saving considerable time (no drill). Various ways of wiring are possible: directly with the conduit or directly with the cable or with cable/conduit gland (traditional).

# Ordering Information

## IP65 Europa Series



- IP65 Europa watertight series for outdoor applications, heating rooms, garages, farms, cellars, photovoltaic installations, etc.
- Rated current  $I_n = 125A$ ; Protection degree IP65; Protection class II (double insulated); Shock resistance 6 Joules (IK level 08)
- In thermoplastic material, self-extinguishing and resistant to abnormal heat and fire up to 650°C (glow wire flammability index) in compliance with IEC 60695-2-11 Standard
- Installation temperature from -25°C to +60°C; resistant to heat: ball thermopressure up to +85°C in compliance with EN 60695-10-2 Standard
- Rated isolation voltage: 1000 V AC; 1500 V DC
- Consumer units manufactured in compliance with CEI 23-49 (1996) + V1 + V2, CB certificate IEC 60670-24 Standards
- IP65 Europa Series wall-mounting consumer units obtained the IMQ mark of approval
- IP65 Europa consumer units are supplied complete with: module covers; 4 screw-cover caps to guarantee protection class II; accessories for attaching the hinges to the front; 1 self-adhesive indicator strip per row; 1 plate for CEI 23-51 certification, instruction sheet

Description	N° module	Dimensions HxWxD	Order code	Price
	[18 mm]	[mm]		
<b>1-row</b>				
IP65 Europa, wall-mounting, RAL 7035 grey, with opaque door	4	140x220x140	12724	
IP65 Europa, wall-mounting, RAL 7035 grey, with transparent, smoky door	4	140x220x140	12744	
IP65 Europa, wall-mounting, RAL 7035 grey, with opaque door	8	205x220x140	12728	
IP65 Europa, wall-mounting, RAL 7035 grey, with transparent, smoky door	8	205x220x140	12748	
IP65 Europa, wall-mounting, RAL 7035 grey, with opaque door	12	275x220x140	12732	
IP65 Europa, wall-mounting, RAL 7035 grey, with transparent, smoky door	12	275x220x140	12752	
IP65 Europa, wall-mounting, RAL 7035 grey, with opaque door	18	380x220x140	12733	
IP65 Europa, wall-mounting, RAL 7035 grey, with transparent, smoky door	18	380x220x140	12753	



2CSC400030F0208

IP65 Europa



2CSC400030F0209

IP65 Europa



2CSC400030F0210

IP65 Europa



2CSC400030F0211

IP65 Europa



2CSC400030F0212

IP65 Europa



2CSC400030F0213

IP65 Europa



2CSC400030F0214

IP65 Europa



2CSC400030F0215

IP65 Europa

Description	N° module	Dimensions HxWxD	Order code	Price
	[18 mm]	[mm]		
<b>2-row</b>				
IP65 Europa, wall-mounting, RAL 7035 grey, with opaque door	24	275x370x140	12734	
IP65 Europa, wall-mounting, RAL 7035 grey, with transparent, smoky door	24	275x370x140	12754	
IP65 Europa, wall-mounting, RAL 7035 grey, with opaque door	36	380x370x140	12735	
IP65 Europa, wall-mounting, RAL 7035 grey, with transparent, smoky door	36	380x370x140	12755	
<b>3-row</b>				
IP65 Europa, wall-mounting, RAL 7035 grey, with opaque door	36	275x570x140	12736	
IP65 Europa, wall-mounting, RAL 7035 grey, with transparent, smoky door	36	275x570x140	12756	
IP65 Europa, wall-mounting, RAL 7035 grey, with opaque door	54	380x570x140	12738	
IP65 Europa, wall-mounting, RAL 7035 grey, with transparent, smoky door	54	380x570x140	12758	



# Ordering Information

## IP65 Europa Series - Accessories



Terminal blocks

2CSC400030F0216



Terminal holders

2CSC400030F0217

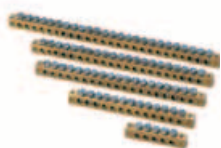

Terminal bars

2CSC400030F0218

6

### Terminal blocks

The complete terminal blocks are composed of a combination of terminal holders and terminal bars as indicated in the description, with the terminal bars already mounted on terminal holders. Configuration of the complete terminal block is standard. For different requirements (customized terminal block), the terminal holders and bars must be procured separately in the versions indicated in the table.

Description	Order code	Price	Box/Pack No items
<b>Terminal blocks</b>			
For 4 modules – composed of 12538x2 + 12531x2	12490		10/60
For 8 modules – composed of 12539x2 + 12531x2	12491		10/60
For 12 modules – composed of 12540x1 + 12531x1 + 12532x1	12492		10/40
For 18 modules – composed of 12543x1 + 12531x1 + 12535x1	12498		10/40
For 24 modules – composed of 12540x2 + 12533x2	12494		10/40
For 36 modules (3 rows) – composed of 12540x2 + 12534x2	12493		10/40
For 36 modules (2 rows) – composed of 12543x2 + 12534x2	12507		10/40
For 54 modules – composed of 12543x2 + 12535x2	12497		10/40

### Terminal holders

For 4 modules – for IP65 Europa 12724 and 12744	12538		12/360
For 8 modules – for IP65 Europa 12728 and 12748	12539		12/360
For 12 modules per row – for IP65 Europa 12732, 12752, 12734, 12754, 12736 and 12756	12540		12/144
For 18 modules per row – for IP65 Europa 12733, 12753, 12735, 12755, 12738 and 12758	12543		12/108

The terminal block is completed by combining the necessary terminal bars to the terminal holders, taking care to keep the terminal bars separated from each other.

### Terminal bars

5 holes x Ø 4.5	12531		20/240
10 holes Ø 4.5 mm and 3 holes Ø 5.6 mm <sup>2</sup>	12532		20/240
16 holes Ø 4.5 mm and 3 holes Ø 5.6 mm <sup>2</sup>	12533		20/240
15 holes Ø 4.5 mm and 6 holes Ø 5.6 mm <sup>2</sup>	12534		20/240
19 holes Ø 4.5 mm and 6 holes Ø 5.6 mm <sup>2</sup>	12535		20/240

The terminal block is completed by combining the necessary terminal bars to the terminal holders, taking care to keep the terminal bars separate from each other.

Terminal holders and terminal bars are supplied separately. In this way, by inserting one or two terminal bars into the terminal holder you can create the best terminal for your requirements, with the advantage of obtaining a terminal block that is cheap as well as personalised, due to the fact that you only need to use material that is really necessary. Some standard configurations are illustrated in the table. All the possible configurations that can be created for each type of consumer unit are given in the technical details.



2CSC400030F0219

Spare doors



2CSC400030F0220

Closure



2CSC400030F0221

Plastic wall brackets



2CSC400030F0222

Cover strips

Description	Order code	Price	Box/Pack No items
<b>Spare doors</b>			
Opaque Door, RAL 7035 grey, for IP65 Europa 12724 and 12744	12568		1/8
Opaque Door, RAL 7035 grey, for IP65 Europa 12728 and 12748	12569		1/10
Opaque Door, RAL 7035 grey, for IP65 Europa 12732 and 12752	12570		1/8
Opaque Door, RAL 7035 grey, for IP65 Europa 12734 and 12754	12571		1/5
Opaque Door, RAL 7035 grey, for IP65 Europa 12736 and 12756	12572		1/10
Opaque Door, RAL 7035 grey, for IP65 Europa 12738 and 12758	12573		1/8
Opaque Door, RAL 7035 grey, for IP65 Europa 12733 and 12753	12584		1/20
Opaque Door, RAL 7035 grey, for IP65 Europa 12735 and 12755	12585		1/8
Transparent, smoky door for IP65 Europa 12724 and 12744	12578		1/8
Transparent, smoky door for IP65 Europa 12728 and 12748	12579		1/10
Transparent, smoky door for IP65 Europa 12732 and 12752	12580		1/8
Transparent, smoky door for IP65 Europa 12734 and 12754	12581		1/5
Transparent, smoky door for IP65 Europa 12736 and 12756	12582		1/10
Transparent, smoky door for IP65 Europa 12738 and 12758	12583		1/8
Transparent, smoky door for IP65 Europa 12733 and 12753	12586		1/20
Transparent, smoky door for IP65 Europa 12735 and 12755	12587		1/8
<b>Closure</b>			
Lock with Key for IP65 Europa	12866		10/300
<b>Plastic wall brackets</b>			
Wall fixing brackets in insulating material (4 pieces)	12858		20/240
<b>Cover strips</b>			
RAL 7035 grey module cover strips for 1 module	12861		50/1500
RAL 7035 grey module cover strips for 4 modules	12863		25/300



# Ordering Information

## IP65 Europa Series - Accessories



2CSC400030F0223

Spare Flanges



2CSC400030F0224

Semi-flush-mounting frame

6

Description	Order code	Price	Box/Pack No items
<b>Spare Flanges</b>			
Flange for 8 modules, bi-material for boxes width 205 mm	12600		30/120
Flange for 12, 24, 36 (12x3 rows) modules, bi-material for boxes width 275 mm	12601		20/80
Flange for 18, 36 (18x2 rows), 54 modules, bi-material for boxes width 385 mm	12602		20/80
Rigid flange, for 8 modules per row	1SL0550A00		30/120
Rigid flange, for 12 modules per row	1SL0551A00		20/80
Rigid flange, for 18 modules per row	1SL0552A00		20/80
<b>Semi-flush-mounting frame</b>			
Semi-flush-mounting frame box 140 x 220 for IP65 Europa 12724 and 12744	12590		5/20
Semi-flush-mounting frame box 205 x 220 for IP65 Europa 12728 and 12748	12591		5/20
Semi-flush-mounting frame box 275 x 220 for IP65 Europa 12732 and 12752	12592		5/20
Semi-flush-mounting frame box 275 x 370 for IP65 Europa 12734 and 12754	12593		5/20
Semi-flush-mounting frame box 275 x 570 for IP65 Europa 12736 and 12756	12594		5/5
Semi-flush-mounting frame box 380 x 570 for IP65 Europa 12738 and 12758	12595		5/5
Semi-flush-mounting frame box 380 x 220 for IP65 Europa 12733 and 12753	12596		5/5
Semi-flush-mounting frame box 380 x 370 for IP65 Europa 12735 and 12755	12597		5/5



## IP40 Wall-mounting covers

### The details make the difference

Rated maximum current 63A, installation temperature from -25°C to +60°C

In thermoplastic, self-extinguishing and resistant to abnormal heat and fire up to 650°C (glow wire test) in compliance with IEC 60695-2-11 Standard



Colors, white RAL 9016 and grey RAL 7035

Supplied with module covers and instruction sheet



The wall covers are mainly for residential and commercial (shops, office buildings, etc.) applications.



The IP40 Wall covers are available in white, RAL 9016 and in grey, RAL 7035. Both ranges are without door and available with 2, 4 and 6 modules.



The screw lead sealing (code 12860) can also be used for the range of IP40 wall covers.

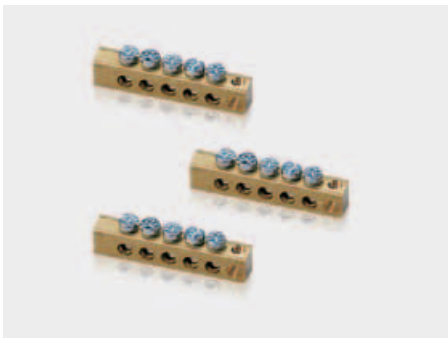

The terminal bar can be fixed to covers by using the supplied screws.



The wall cover with 2 modules can be sealed very easy (with frame of 1/2 modules).

# Ordering Information

## IP40 Wall-mounting covers



- IP40 Wall-mounting covers for residential and commercial applications (houses, shops, office buildings, etc.)
- Rated current  $I_n = 125A$ ; Protection degree IP 40; Protection class II (double insulated); Shock resistance 6 Joules (IK level 08)
- In thermoplastic material, self-extinguishing and resistant to abnormal heat and fire up to 650°C (glow wire flammability index) in compliance with IEC 60695-2-11 Standard
- Installation temperature from -25°C to +60°C; resistant to heat: ball thermopressure up to +85°C in compliance with EN 60695-10-2 Standard
- IP40 Wall-mounting covers are produced in compliance with CEI 23-49 (1996) + V1 + V2, CB certificate IEC 60670-24 Standards
- IP40 Wall-mounting covers obtained the IMQ mark of approval IMQ mark

Description	N° module	Dimensions HxWxD	Order code	Price
	[18 mm]	[mm]		
<b>1-row</b> <input type="checkbox"/>				
IP40 Wall-mounting cover, RAL 9016 white	2	50x140x65	1SL2402A00	
IP40 Wall-mounting cover, RAL 7035 grey	2	50x140x65	12422	
IP40 Wall-mounting cover, RAL 9016 white	4	95x160x65	1SL2404A00	
IP40 Wall-mounting cover, RAL 7035 grey	4	95x160x65	12424	
IP40 Wall-mounting cover, RAL 9016 white	6	140x160x65	1SL2406A00	
IP40 Wall-mounting cover, RAL 7035 grey	6	140x160x65	12426	

# Ordering Information

## IP40 Wall-mounting covers - Accessories



2CSC400030F0231

Terminal bars



2CSC400030F0232

Screw lead sealing accessory

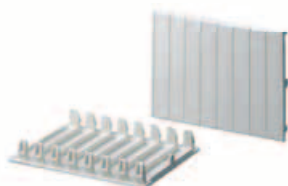

2CSC400030F0233

Cover strips

Description	Order code	Price	Box/Pack No items
<b>Terminal bars</b>			
Terminal bar - 2 holes x Ø 4.5 mm and 3 holes x Ø 5.6 mm for IP40 Wall-mounting covers type 1SL2402A00, 12422, 1SL2404A00, 12424, 1SL2406A00, 12426	12502		25/750
The terminal bar can be fixed to covers using the supplied screws.			
<b>Screw lead sealing accessory</b>			
Lead coating accessory	12860		50/1500
<b>Cover strips</b>			
RAL 9016 white module cover strips for 1 module	1SL2857A00		50/1500
RAL 9016 white module cover strips for 4 modules	1SL2859A00		25/300
RAL 7035 grey module cover strips for 1 module	12861		50/1500
RAL 7035 grey module cover strips for 4 modules	12863		25/300

## IP44, IP55 and IP65 Junction boxes

### The details make the difference

High resistance to heat and chemical and atmospheric agents

Installation temperature from -25°C to +60°C



6

Three lid types available: press-on, with steel screws and with plastic screws with a ¼ turn closing

Boxes with protection degree IP55 and IP65 are composed of a patented lid produced in a single pressing phase together with its seal



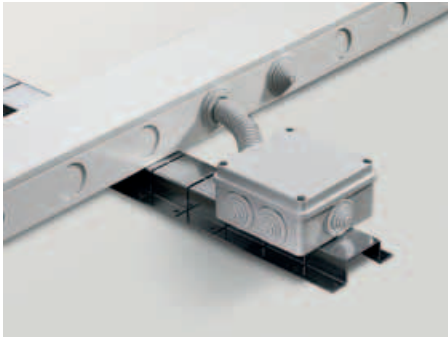

A wide range for all needs. There are IP44 for press-on lid boxes with cable glands, IP55 for screw-on lid boxes with cable glands and IP65 for screw-on lid box with smooth sides.



Some versions of the IP44 and IP55 junction boxes are already equipped with cable glands.



Boxes with protection degree IP55 and IP65 are composed of a patented lid produced in a single pressing phase together with its seal.



Now new: All IP65 junction boxes (with smooth sides) are manufactured in halogen free thermoplastic material.

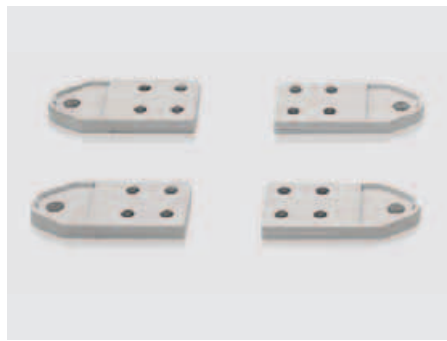

Wall-mounting is also possible. All junction boxes measuring 160x135, 220x170 and 310x240 mm can be mounted on the wall with brackets (accessory; code 12858).



All IP44, IP55 and IP65 junction boxes are also available in thermoplastic material, self-extinguishing in compliance with UL 94 V2 Standard and resistant to abnormal heat and fire up to 960°C GWT.

# Ordering Information

## IP44, IP55 and IP65 Junction boxes



2CSC400030F0234

IP44 boxes



2CSC400030F0235

IP44 boxes



2CSC400030F0236

IP55

- IP44, IP55 and IP65 Junction boxes for swimming pool control equipment, washing car centers, garages, building services, automatic garden lighting and watering, traffic signs, photovoltaic installations.
- Protection degree: IP44 for press-on lid boxes with cable glands, IP55 for screw-on lid boxes with cable glands, IP65 for screw-on lid box with smooth sides
- Shock resistant: IK07 for IP44 boxes, IK08 for IP55 and IP65 boxes
- IP44 and IP55 boxes with press-on lids in thermoplastic material, self-extinguishing in compliance with UL 94 HB Standard and resistant to abnormal heat and fire up to 650°C (glow wire flammability index) in compliance with IEC 60695-2-11 Standard
- IP65 boxes with screw-on lids in halogen free thermoplastic material, self-extinguishing in compliance with UL 94 HB Standard and resistant to abnormal heat and fire up to 650°C (glow wire flammability index) in compliance with IEC 60695-2-11 Standard
- Installation temperature from -25°C to +60°C; Resistant to heat: ball thermopressure up to +85°C for IP44, IP55 and IP65 junction boxes
- Boxes with protection degree IP55 and IP65 are composed of a patented lid produced in a single pressing phase together with its seal
- All junction boxes made in compliance with IEC 60670-1 and IEC 60670-22 Standards
- IP44 and IP55 junction boxes in thermoplastic material obtained the IMQ mark of approval
- All the boxes are RoHS compliance

All IP44, IP55 and IP65 junction boxes are also available in thermoplastic material, self-extinguishing in compliance with UL 94 V2 Standard and resistant to abnormal heat and fire up to 960°C (glow wire flammability index) in compliance with IEC 60695-2-11 Standard.

Description	Dimensions HxWxD	Order code	Price	Box/Pack No items
	[mm]			
<b>IP44 boxes - GWT 650°C</b>				
With cable glands and press-on lid				
IP44-Snap-on cover - GWT 650°C	Ø 60 - H 35	800		240/240
IP44-Snap-on cover - GWT 650°C	Ø 80 - H 40	802		144/144
IP44-Snap-on cover - GWT 650°C	65x65x32	808		168/168
IP44-Snap-on cover - GWT 650°C	80x80x40	810		100/100
<b>IP55 waterproof boxes with plastic 1/4 turn screws - GWT 650°C</b>				
With cable glands and low screw-on lid RAL 7035				
IP55-Cable glands-low lid-1/4TS GWT 650°C	100x100x50	1SL0816A00		1/54
IP55-Cable glands-low lid-1/4TS GWT 650°C	105x70x50	1SL0820A00		1/70
IP55-Cable glands-low lid-1/4TS GWT 650°C	100x100x80	1SL0821A00		1/40
IP55-Cable glands-low lid-1/4TS GWT 650°C	153x110x66	1SL0822A00		1/32
IP55-Cable glands-low lid-1/4TS GWT 650°C*	160x135x77	1SL0824A00		1/18
IP55-Cable glands-low lid-1/4TS GWT 650°C*	220x170x80	1SL0826A00		1/12
IP55-Cable glands-low lid-1/4TS GWT 650°C*	310x240x110	1SL0828A00		1/6

\* Can be wall-mounted using wall brackets code 12858.



IP65

2CSC400030F0237



IP65

2CSC400030F0238



IP55

2CSC400030F0239



IP65

2CSC400030F0240



IP65

2CSC400030F0241

Description	Dimensions HxWxD [mm]	Order code	Price	Box/Pack No items
<b>IP65 waterproof boxes with plastic 1/4 turn screws - GWT 650°C halogen free</b>				
With smooth sides and low screw-on lid RAL 7035				
IP65-Smooth-low lid-1/4TS GWT 650°C halogen free	100x100x50	1SL0846A00		1/60
IP65-Smooth-low lid-1/4TS GWT 650°C halogen free	105x70x50	1SL0850A00		1/100
IP65-Smooth-low lid-1/4TS GWT 650°C halogen free	100x100x80	1SL0851A00		1/40
IP65-Smooth-low lid-1/4TS GWT 650°C halogen free	153x110x66	1SL0852A00		1/32
IP65-Smooth-low lid-1/4TS GWT 650°C halogen free*	160x137x77	1SL0854A00		1/24
IP65-Smooth-low lid-1/4TS GWT 650°C halogen free*	220x170x80	1SL0856A00		1/12
IP65-Smooth-low lid-1/4TS GWT 650°C halogen free*	310x240x110	1SL0858A00		1/6
<b>With smooth sides and transparent low screw-on lid</b>				
IP65-Smooth-low transparent lid-1/4TS GWT 650°C halogen free	153x110x66	1SL0872A00		1/34
IP65-Smooth-low transparent lid-1/4TS GWT 650°C halogen free*	160x135x77	1SL0874A00		1/24
IP65-Smooth-low transparent lid-1/4TS GWT 650°C halogen free*	220x170x80	1SL0876A00		1/12
IP65-Smooth-low transparent lid-1/4TS GWT 650°C halogen free*	310x240x110	1SL0878A00		1/6
<b>IP55 waterproof boxes with steel screws - GWT 650°C</b>				
With cable glands and high screw-on lid RAL 7035				
IP55- Cable glands-low lid - GWT 650°C	100x100x50	00816		1/54
IP55- Cable glands-low lid - GWT 650°C	105x70x50	00820		1/70
IP55- Cable glands-low lid - GWT 650°C	100x100x80	00821		1/40
IP55- Cable glands-low lid - GWT 650°C	153x110x66	00822		1/32
<b>IP65 waterproof boxes with steel screws - GWT 650°C halogen free</b>				
With smooth sides and high screw-on lid RAL 7035				
IP65- Smooth W.-low lid - GWT 650°C halogen free	100x100x50	00846		1/60
IP65- Smooth W.-low lid - GWT 650°C halogen free	105x70x50	00850		1/100
IP65- Smooth W.-low lid - GWT 650°C halogen free	100x100x80	00851		1/40
IP65- Smooth W.-low lid - GWT 650°C halogen free	153x110x66	00852		1/34
With Smooth sides and transparent high screw-on lid				
IP65- Smooth W.-transparent. low lid-153X110X66 GWT 650°C halogen free	151x110x66	00872		1/34

\* Can be wall-mounted using wall brackets code 12858.

# Ordering Information

## IP44, IP55 and IP65 Junction boxes



2CSC400030F0242

IP55



2CSC400030F0243

IP65



2CSC400030F0244

IP65

Description	Dimensions HxWxD [mm]	Order code	Price	Box/Pack No items
<b>IP55 waterproof boxes with plastic 1/4 turn screws - GWT 650°C</b>				
With Cable glands and high screw-on lid RAL 7035				
IP55-Cable glands-high lid -1/4TS GWT 650°C	160x135x150	1SL0830A00		1/16
IP55-Cable glands-high lid -1/4TS GWT 650°C	220x170x150	1SL0832A00		1/8
IP55-Cable glands-high lid -1/4TS GWT 650°C	310x240x160	1SL0834A00		1/4
<b>IP65 waterproof boxes with plastic 1/4 turn screws - GWT 650°C halogen free</b>				
With Smooth sides and high screw-on lid RAL 7035				
IP65-Smooth-high lid -1/4TS GWT 650°C halogen free	160x135x150	1SL0860A00		1/16
IP65-Smooth-high lid -1/4TS GWT 650°C halogen free	220x170x150	1SL0862A00		1/8
IP65-Smooth-high lid -1/4 TS GWT 650°C halogen free	310x240x160	1SL0864A00		1/4
With Smooth sides and transparent high screw-on lid				
IP65-Smooth-high transparent lid -1/4TS GWT 650°C halogen free*	160x135x150	1SL0880A00		1/16
IP65-Smooth-high transparent lid -1/4TS GWT 650°C halogen free*	220x170x150	1SL0882A00		1/8
IP65-Smooth-high transparent lid -1/4TS GWT 650°C halogen free*	310x240x160	1SL0884A00		1/4

\* Can be wall-mounted using wall brackets code 12858.

# Ordering Information

## IP 44, IP 55 and IP 65 junction boxes in thermoplastic material



2CSC400030F0245

IP44



2CSC400030F0246

IP44



2CSC400030F0247

IP55



2CSC400030F0248

IP65



2CSC400030F0249

IP65

Description	Dimensions HxWxD	Order code	Price	Box/Pack No items
	[mm]			
<b>IP 44 boxes - GWT 960 °C</b>				
With cable glands and press-on lid	Ø 60 - H 35	1SL0900A00		240/240
	Ø 80 - H 40	1SL0901A00		144/144
	65x65x32	1SL0902A00		168/168
	80x80x40	1SL0903A00		100/100
<b>IP 55 waterproof boxes with plastic 1/4 turn screws - GWT 960 °C</b>				
With cable glands and low screw-on lid RAL 7035	100x100x50	1SL0916A00		1/54
	105x70x50	1SL0920A00		1/70
	100x100x80	1SL0921A00		1/40
	153x110x66	1SL0922A00		1/32
	160x135x77	1SL0924A00(*)		1/18
	220x170x80	1SL0926A00(*)		1/12
	310x240x110	1SL0928A00(*)		1/6
<b>IP 65 waterproof boxes with plastic 1/4 turn screws - GWT 960 °C</b>				
With smooth sides and low screw-on lid RAL 7035	100x100x50	1SL0946A00		1/60
	105x70x50	1SL0950A00		1/100
	100x100x80	1SL0951A00		1/40
	153x110x66	1SL0952A00		1/32
	160x137x77	1SL0954A00(*)		1/24
	220x170x80	1SL0956A00(*)		1/12
	310x240x110	1SL0958A00(*)		1/6
With smooth sides and transparent low screw-on lid	153x110x66	1SL0972A00		1/34
	160x135x77	1SL0974A00(*)		1/24
	220x170x80	1SL0976A00(*)		1/12
	310x240x110	1SL0978A00(*)		1/6

(\*) Can be wall-mounted using wall brackets code 12 858.

# Ordering Information

## IP 44, IP 55 and IP 65 junction boxes in thermoplastic material



2CSC400030F0250

IP55



2CSC400030F0251

IP65



2CSC400030F0252

IP65



2CSC400030F0253

IP55



2CSC400030F0254

IP65



2CSC400030F0255

IP65

Description	Dimensions HxWxD	Order code	Price	Box/Pack No items
	[mm]			
<b>IP 55 waterproof boxes with steel screws - GWT 960 °C</b>				
With cable glands and high screw-on lid RAL 7035	100x100x50	1SL0904A00		1/54
	105x70x50	1SL0905A00		1/70
	100x100x80	1SL0906A00		1/40
	153x110x66	1SL0907A00		1/32
<b>IP 65 waterproof boxes with steel screws - GWT 960 °C</b>				
With smooth sides and high screw-on lid RAL 7035	100x100x50	1SL0908A00		1/60
	105x70x50	1SL0909A00		1/100
	100x100x80	1SL0910A00		1/40
	153x110x66	1SL0911A00		1/34
With smooth sides and transparent high screw-on lid	151x110x66	1SL0912A00		1/34
<b>IP 55 waterproof boxes with plastic 1/4 turn screws - GWT 960 °C</b>				
With cable glands and high screw-on lid RAL 7035	160x135x150	1SL0930A00		1/16
	220x170x150	1SL0932A00		1/8
	310x240x160	1SL0934A00		1/4
<b>IP 65 waterproof boxes with plastic 1/4 turn screws - GWT 960 °C</b>				
With smooth sides and high screw-on lid RAL 7035	160x135x150	1SL0960A00		1/16
	220x170x150	1SL0962A00		1/8
	310x240x160	1SL0964A00		1/4
With smooth sides and transparent high screw-on lid	160x135x150	1SL0980A00 <sup>(*)</sup>		1/16
	220x170x150	1SL0982A00 <sup>(*)</sup>		1/8
	310x240x160	1SL0984A00 <sup>(*)</sup>		1/4

<sup>(\*)</sup> Can be wall-mounted using wall brackets code 12 858.



# Ordering Information

## IP44, IP55 and IP65 Junction boxes

### Accessories



2CSC400030F0256

PG pitch



2CSC400030F0257

PG pitch



2CSC400030F0258

metric pitch



2CSC400030F0259

metric pitch

#### Cable glands and nuts - PG pitch

Pitch	Torque values		For cables diameter		Cable gland		Nut x cable gland		Cable clamp	Nuts x cable
	N x m	Min (mm)	Max (mm)	Order code	Price	Order code	Price	Box/pack	Box/pack	
Pg									No Items	No Items
9	3.75	6.5	8.5	00931		00941		100/500	100/3000	
11	3.75	8	10	00932		00942		100/500	100/3000	
13.5	3.75	8	11	00933		00943		50/500	50/1500	
16	5	11	14	00934		00944		50/300	50/1500	
21	7.5	14.5	18	00935		00945		50/300	50/1500	
29	7.5	19	26	00936		00946		25/150	50/600	
36	7.5	30	34	00937		00947		25/75	25/300	
42	7.5	30	38	00938		00948		15/60	25/300	

In compliance with CEI EN 50262 Standard.

#### Cable glands and nuts - metric pitch

Pitch	Torque values		Cables diameter		Cable gland		Nut		Box/pack	Cable clamp
	N x m	Min (mm)	Max (mm)	Order code	Price	Order code	Price	No Items	No Items	
Pg										
12 x 1.5	2.7	3.5	7	00951		00961		100/1200	100/3000	
16 x 1.5	5	5.5	10	00952		00962		100/500	100/3000	
20 x 1.5	7	7	13	00953		00963		100/500	50/1500	
25 x 1.5	7.5	10	17	00954		00964		50/250	50/1500	
32 x 1.5	8	12	21	00955		00965		25/150	50/500	
40 x 1.5	8	19	28	00956 *		00966		25/75	25/300	
50 x 1.5	10	27	35	00957 *		00967		15/60	25/300	
63 x 1.5	10	34	45	00958 *		00968		10/40	20/100	

In compliance with CEI EN 50262 Standard.

\* Cable clamps and M40, M50 and M63 nuts are available on request.

#### Technical characteristics of metric cable clamps:

- Protection degree IP68
- Material: polyamide 6.6, self-extinguishing material according to UL94 V2 Standard and resistant to abnormal heat and to fire up to 750°C (glow wire test) according to IEC 60695-2-11 Standard
- Operational temperature: from -20°C up to +120°C (short period of time)
- Colour: RAL 7035 grey;
- Neoprene seal;
- Thread pitch: 1.5 mm; Thread angle: 60°
- Tightening with a plate crown on the whole diameter of cable (excluded the possibility to damage the cable itself)
- Possibility to recover the cable clamp without compromising its efficiency.

#### Technical characteristics nuts of with metric pitch collar

- Material: polyamide 6.6, self-extinguishing material according to UL94 V2 Standard and resistant to abnormal heat and to fire up to 750°C (glow wire test) according to IEC 60695-2-11 Standard
- Operational temperature: from -20°C up to +120°C (continuous) from -20°C up to +120°C (short period of time)
- Colour: RAL 7035 grey
- Thread pitch: 1.5 mm; Thread angle: 60°.



# Ordering Information

## IP44, IP55 and IP65 Junction boxes

### Accessories

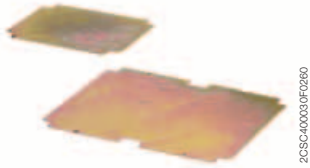

Metal base plates

2CSC400030F0280



Cable Clamps

2CSC400030F0281



Conduit clamps

2CSC400030F0282



Unions

2CSC400030F0283

6

Description	Order code	Price	Box/Pack No items
<b>Metal base plates</b>			
Metal base plate for boxes with dimensions 160x135x77	1/10		00900
Metal base plate for boxes with dimensions 220x170x80	1/5		00902
Metal base plate for boxes with dimensions 310x240x110	1/5		00904
All metal base plates listed above are equipped with fixing screws type 3.5x9.5.			
<b>Cable Clamps - Protection Degree: IP55</b>			
Cable clamp for conduit Ø 20 mm	100/1500		00908
Cable clamp for conduit Ø 25 mm	100/1000		00910
Cable clamp for conduit Ø 32 mm	50/400		00912
<b>Conduit clamps - Box Connector - Protection Degree: IP67</b>			
Conduit clamp Ø 16 mm	00430		500/500
Conduit clamp Ø 20 mm	00431		300/300
Conduit clamp Ø 25 mm	00432		150/150
Conduit clamp Ø 32 mm	00433		100/100
Conduit clamp Ø 40 mm	00434		50/50
Conduit clamp Ø 50 mm	00435		50/50
<b>Unions - Protection Degree: IP55</b>			
Union connector PG 16 IP55 Ø 23 mm	13874		10/500
Union connector PG 21 IP55 Ø 28,5 mm	13875		100/400
Union connector PG 29 IP55 Ø 37 mm	13876		100/200



## CJ8/16 Cable joint

The details make the difference

Transparent lid  
allows visual  
inspection

After closing the  
screw-type cap  
on top, the cable  
joint can be put  
into the ground  
immediately, it no  
longer needs to be  
kept level until the  
resin has hardened

Cut-outs on all  
four sides to use  
a feedthrough,  
T- or X-branched  
sleeve

Suitable for cable  
thicknesses  
from 8 mm  
up to 14.5 mm





Cable with a diameter of 8 to 14.5 mm can be cut and prepared for use in the cable joint. The inserts can easily slide over the cable.



The electrical connections can be made outside the box.



The required number of entries can be made by removing the cutouts with a set of pliers.



The assembly can slide into the box and the inserts will assure that the resin will not leak out during the hardening process.



There is more than enough space inside the box for all the connections.



The clear lid allows for visual inspection.



The resin is supplied as 2 split components resin and activator. The resin and activator need to be mixed until a homogenous colour is reached. (without need to touch material).



The resin can be poured into the box (funnel included).



After closing of the screw type lid the box needs no longer to be level and there is no need to wait until the resin has completely hardened before putting the joint back into the ground. (saves time).

# Ordering Information

## CJ8/16 Cable joint



2CSC400030F0264

Unique design, eliminates the need for foam seals. Cables can be connected outside the casing. Ample space for both joining and derivation. Transparent lid allows for visual inspection.

Comes complete with resin, gloves, sand-linen, three inserts and instruction manual. The universal underground jointing solution for professionals and do-it-yourself alike.

Description	Order code	Price
Cable Joint Kit: universal connection; universal T- or X- split; for cables 8-14,5 mm	1SPA007189F0101	

Cable Joint Kit





# Technical details

## UK500 Series

### UK500 IP30 Flush-mounting consumer units with and without door

Code	UK512N2	UK524N3	UK536N3	UK548N3
	UK510E	UK520E	UK530E	UK540E
	UK510ETT	UK520ETT	UK530ETT	UK540ETT
	UK512BN2	UK524BN3	UK536BN3	UK548BN3
Number of Modules	12	24	36	48
Colour	RAL 9016 white	RAL 9016 white	RAL 9016 white	RAL 9016 white
Without door	YES	YES	YES	YES
With opaque door	YES	YES	YES	YES
With transparent door	YES	YES	YES	YES
Double Insulation	YES	YES	YES	YES
Resistance to Heat	GWT 850°	GWT 850°	GWT 850°	GWT 850°
Type of Material	Thermo-plastic, Sheet steel	Thermo-plastic, Sheet steel	Thermo-plastic, Sheet steel	Thermo-plastic, Sheet steel
Shock Resistance	2 Joule (IK 07)	2 Joule (IK 07)	2 Joule (IK 07)	2 Joule (IK 07)
Installation Temperature	-5°C ÷ +40°C	-5°C ÷ +40°C	-5°C ÷ +40°C	-5°C ÷ +40°C
Protection degree	IP 30	IP 30	IP 30	IP 30
Max Dissipation Power	13W	15W	19W	21W
Cable Holding System by hollow wall mounting	YES	YES	YES	YES
Designed for Input	push and stay design	push and stay design	push and stay design	push and stay design
Extractable Frame	YES	YES	YES	YES

6

## Power loss

DIN 43871 by over temperature  $\Delta T$

Type	Power loss (W)		
	$\Delta T$ 20K	$\Delta T$ 25K	$\Delta T$ 30K
UK512N2, UK510E, UK510ETT, UK512BN2	10,0	13,0	16,0
UK524N3, UK520E, UK520ETT, UK524BN3	11,5	15,0	19,0
UK536N3, UK530E, UK530ETT, UK536BN3	14,5	19,0	24,0
UK548N3, UK540E, UK540ETT, UK548BN3	16,5	21,5	27,0



# Technical details

## Unibox Series

### Wall-mounting consumer units IP40 Unibox Series with door

Code	12 238 12 258	12 242 12 262	12 244 12 264	12 246 12 266	12 247 12 267
Number of modules	8 + 1	12 + 1	24 + 2	36 + 3	54 + 3
Colour	RAL 9016 white	RAL 9016 white	RAL 9016 white	RAL 9016 white	RAL 9016 white
With transparent door	yes	yes	yes	yes	yes
With opaque door	yes	yes	yes	yes	yes
Double insulation	yes	yes	yes	yes	yes
Resistance to heat	GWT 650°C	GWT 650°C	GWT 650°C	GWT 650°C	GWT 650°C
Type of material	Thermo-plastic	Thermo-plastic	Thermo-plastic	Thermo-plastic	Thermo-plastic
Shock resistance	10 Joule (IK 09)	10 Joule (IK 09)	10 Joule (IK 09)	10 Joule (IK 09)	10 Joule (IK 09)
Installation temperature	-25°C ÷ +60°C	-25°C ÷ +60°C	-25°C ÷ +60°C	-25°C ÷ +60°C	-25°C ÷ +60°C
Resistance to heat	up to +85 °C	up to +85 °C	up to +85 °C	up to +85 °C	up to +85 °C
Protection degree	IP40	IP40	IP40	IP40	IP40
Max dissipation power*	20 W	30 W	40 W	45 W	54 W
Cable holding system	yes	yes	yes	yes	yes
Designed for input	Conduits Ø 25÷32 mm Trunkings up to 200X60 mm	Conduits Ø 25÷32 mm Trunkings up to 200X60 mm	Conduits Ø 25÷32 mm Trunkings up to 200X60 mm	Conduits Ø 25÷32 mm Trunkings up to 200X60 mm	Conduits Ø 25÷32 mm Trunkings up to 200X60 mm
Extractable frame	-	-	yes	yes	yes

\* Data concerning dissipative power have been obtained by following the instructions in CEI 23-49 Standard, with a temperature difference of Dt = 30 °C.

6

### Reaction to chemical agents \*

	Cold water	Hot water	Sulphuric acid 40%	Hydrochloric acid 35%	Acetic acid 10%	Benzole	Gasoline	Acetone	Ethyl alcohol	Ammonia liquid	Dichloromethane	Diesel oil-naphta	Mineral oils and grases	Food oils and grases	Perchloroethylene	Trichloroethylene	Ethylether	Ozone	Toluene	Methanol	Spirits	Milk	Fruit juices	Fluoride hydrocarbons	Lye-washes	Cleansings	Water solution	
IP40 Unibox	■	■	▲	▲	■	●	■	●	▲	■	●	■	■	■	●	●	●	■	●	▲	■	■	■	■	●	■	■	■

■ resistant   
 ▲ partially resistant   
 ● not resistant

\* Indications concerning the resistance of the products to chemical agents must be considered as an indication only, and refer to standard conditions (40 °C, integral product).

# Technical details

## Unibox Series

### Possible configurations of terminal holders – terminal bars for consumer units

For consumer units	Terminal holder	Terminal bars
Number of modules	Code	Code x q.ty
8	12 540	12 531 x 1
	12 540	12 531 x 2
	12 540	12 531 x 1 with 12 532 x 1
	12 540	12 532 x 1
	12 540	12 533 x 1
	12 540	12 534 x 1
12, 24, 36 (12 mod. x 2 rows)	12 541	12 531 x 1
	12 541	12 531 x 2
	12 541	12 531 x 1 with 12 532 x 1
	12 541	12 531 x 1 with 12 533 x 1
	12 541	12 531 x 1 with 12 534 x 1
	12 541	12 531 x 1 with 12 535 x 1
	12 541	12 532 x 1
	12 541	12 532 x 2
	12 541	12 533 x 1
	12 541	12 534 x 1
	12 541	12 535 x 1
	18, 54	12 542
12 542		12 531 x 2
12 542		12 531 x 1 with 12 532 x 1
12 542		12 531 x 1 with 12 533 x 1
12 542		12 531 x 1 with 12 534 x 1
12 542		12 531 x 1 with 12 535 x 1
12 542		12 532 x 1
12 542		12 532 x 2
12 542		12 532x1 with 12 533x1
12 542		12 532x1 with 12 534x1
12 542		12 533x1
12 542		12 534x1
12 542		12 535x1

# Technical details

## Alpha Series

### Alpha IP40 Wall-mounting consumer Units with door

	<b>Alpha, 1 row</b>	<b>Alpha, 2 row</b>	<b>Alpha, 3 row</b>	<b>Alpha, 4 row</b>
Number of modules	18	36	54	72
Colour	RAL 9010 white	RAL 9010 white	RAL 9010 white	RAL 9010 white
With smokey door	YES	YES	YES	YES
Double insulation	YES	YES	YES	YES
Resistance to heat	GWT 750°	GWT 750°	GWT 750°	GWT 750°
Type of material	Thermo-plastic	Thermo-plastic	Thermo-plastic	Thermo-plastic
Shock resistance	IK 07	IK 07	IK 07	IK 07
Installation temperature	-5°C ÷ +40°C	-5°C ÷ +40°C	-5°C ÷ +40°C	-5°C ÷ +40°C
Protection degree	IP 41	IP 41	IP 41	IP 41
Designed for input	trunking	trunking	trunking	trunking
Extractable frame	YES	YES	YES	YES

# Technical details

## AT Series

### Wall-mounting Compact Distribution Board IP43 AT Series with door

Code	AT31	AT22E AT41 AT41TE AT42M AT41TE	AT51 AT51TE	AT32 AT32TE AT61 AT61TE	AT42 AT42/2
Number of Modules	36	48	60	72	96
Colour	RAL 9016 white	RAL 9016 white	RAL 9016 white	RAL 9016 white	RAL 9016 white
Without door	NO	NO	NO	NO	NO
With metal door	YES	YES	YES	YES	YES
With transparent door	YES	YES	YES	YES	YES
Double Insulation	YES	YES	YES	YES	YES
Resistance to Heat	750°C	750°C	750°C	750°C	750°C
Type of Material	Thermo-plastic, Sheet steel	Thermo-plastic, Sheet steel	Thermo-plastic, Sheet steel	Thermo-plastic, Sheet steel	Thermo-plastic, Sheet steel
Shock Resistance	10 Joule (IK 09)	10 Joule (IK 09)	5 Joule (IK 08)	5 Joule (IK 08)	5 Joule (IK 08)
Installation Temperature	-5°C ÷ +40°C	-5°C ÷ +40°C	-5°C ÷ +40°C	-5°C ÷ +40°C	-5°C ÷ +40°C
Protection degree	IP43	IP43	IP43	IP43	IP43
Max Dissipation Power	38 W	48 W	60 W	68 W	73 W
Cable Holding System	NO	NO	NO	NO	NO
Designed for Input	Membrane flange	Membrane flange	Membrane flange	Membrane flange	Membrane flange

6

### AT compact distribution board with doors

Type	Weight in kg	Power loss in W
AT22E	9,7	47
AT31	7,5	38
AT32	12,5	60
AT32R2	12	60
AT32TE	12	60
AT32TR2	11,5	60
AT41	9,5	48
AT41R3	10	48
AT41TE	9	48
AT41TR3	9	48
AT42	15	73
AT42/2	15,5	73
AT42M	17,5	73
AT42R3	15	73
AT42TE	13	73

Type	Weight in kg	Power loss in W
AT42TR3	13,5	73
AT43	21,5	96
AT43R3	21,5	96
AT43TR3	18	96
AT51	11,5	58
AT51R4	11,5	58
AT51TE	11,5	58
AT51TR4	11	58
AT52	17	85
AT52/2	18	85
AT52K	17,5	85
AT52R4	18	85
AT52TE	18	85
AT52TR4	16	85
AT53	25	120

AT52 AT52/2 AT52TE AT53M	AT43 AT62 AT62TE	AT72	AT53	AT63E	AT54E
120	144	168	180	216	240
RAL 9016 white	RAL 9016 white	RAL 9016 white	RAL 9016 white	RAL 9016 white	RAL 9016 white
NO	NO	NO	NO	NO	NO
YES	YES	YES	YES	YES	YES
YES	YES	YES	YES	YES	YES
YES	YES	YES	YES	YES	YES
750°C	750°C	750°C	750°C	750°C	750°C
Thermo-plastic, Sheet steel	Thermo-plastic, Sheet steel	Thermo-plastic, Sheet steel	Thermo-plastic, Sheet steel	Thermo-plastic, Sheet steel	Thermo-plastic, Sheet steel
5 Joule (IK 08)	5 Joule (IK 08)	5 Joule (IK 08)	5 Joule (IK 08)	5 Joule (IK 08)	5 Joule (IK 08)
-5°C ÷ +40°C	-5°C ÷ +40°C	-5°C ÷ +40°C	-5°C ÷ +40°C	-5°C ÷ +40°C	-5°C ÷ +40°C
IP43	IP43	IP43	IP43	IP43	IP43
85 W	96 W	111 W	120 W	130W	140 W
NO	NO	NO	NO	NO	NO
Membrane flange	Membrane flange	Membrane flange	Membrane flange	Membrane flange	Membrane flange

Type	Weight in kg	Power loss in W
AT53K	25	120
AT53M	28	120
AT53R4	25,5	120
AT53TR4	21,5	120
AT54E	32	140
AT54K	31	140
AT54R4	32,5	140
AT54TR4	26,5	140
AT61	13,5	68
AT61R5	13,5	68
AT61TE	11,5	68
AT61TR5	12	68
AT62	21	100
AT62K	20,5	100
AT62R5	20	100

Type	Weight in kg	Power loss in W
AT62TE	20	100
AT62TR5	20	100
AT63E	29,5	130
AT63K	29	130
AT63R5	29	130
AT63TR5	24	13
AT64K	36	176
AT72	23,5	111
AT72K	23,5	111
AT72R6	23,5	111
AT72TR6	20	111
AT73K	33,5	153
AT73R6	34	153
AT73TR6	30,5	153

> Maße in mm

# Technical details

## U Series

### Flush-mounting Compact Distribution Board IP30 U Series with door

Code	U41 U41TE U42M	U51 U51TE	U32 U32TE U61 U61TE	U42D U42FPT	U42 U42/2 U42TE
Number of Modules	48	60	72	96	96
Colour	RAL 9016 white	RAL 9016 white	RAL 9016 white	RAL 9016 white	RAL 9016 white
Without door	NO	NO	NO	NO	NO
with metal door	YES	YES	YES	YES	YES
With transparent door	YES	YES	YES	YES	YES
Double Insulation	YES	YES	YES	YES	YES
Resistance to Heat	850°C	850°C	850°C	850°C	850°C
Type of Material	Thermo-plastic, Sheet steel	Thermo-plastic, Sheet steel	Thermo-plastic, Sheet steel	Thermo-plastic, Sheet steel	Thermo-plastic, Sheet steel
Shock Resistance	10 Joule (IK 09)	10 Joule (IK 09)	5 Joule (IK 08)	5 Joule (IK 08)	5 Joule (IK 08)
Installation Temperature	-5°C ÷ +40°C	-5°C ÷ +40°C	-5°C ÷ +40°C	-5°C ÷ +40°C	-5°C ÷ +40°C
Protection degree	IP31	IP31	IP31	IP31	IP31
Max Dissipation Power	47 W	43 W	50 W	60 W	60 W
Cable Holding System by hollow wall mounting	YES	YES	YES	YES	YES
Designed for Input	Nipple flange	Nipple flange	Nipple flange	Nipple flange	Nipple flange
Extractable Frame	YES	YES	YES	YES	YES

6

### U compact distribution board with doors

Type	Weight in kg	Power loss in W
U32	13,5	50
U32R2	13	50
U32TE	12,5	50
U32TR2	11	50
U41	10,5	36
U41R3	10,5	36
U41TE	9	36
U41TR3	9,5	36
U42	15,5	60
U42/2	16,5	60
U42D	16,5	60
U42FPT	17	60
U42M	18,5	60
U42R3	16	60
U42TE	14	60

Type	Weight in kg	Power loss in W
U42TR3	14	60
U43	22,5	80
U43R3	23	80
U43TR3	19,5	80
U51	12,5	43
U51R4	12	43
U51TE	12	43
U51TR4	10,5	43
U52	18,5	69
U52/2	19	69
U52K	18,5	69
U52R4	18	69
U52TE	16	69
U52TR4	16	69
U53	26,5	93

U52 U52/2 U52TE U53M	U43 U62 U62TE	U72	U53	U63E	U54E
120	144	168	180	216	240
RAL 9016 white	RAL 9016 white	RAL 9016 white	RAL 9016 white	RAL 9016 white	RAL 9016 white
NO	NO	NO	NO	NO	NO
YES	YES	YES	YES	YES	YES
YES	YES	YES	YES	YES	YES
YES	YES	YES	YES	YES	YES
850°C	850°C	850°C	850°C	850°C	850°C
Thermo-plastic, Sheet steel	Thermo-plastic, Sheet steel	Thermo-plastic, Sheet steel	Thermo-plastic, Sheet steel	Thermo-plastic, Sheet steel	Thermo-plastic, Sheet steel
5 Joule (IK 08)	5 Joule (IK 08)	5 Joule (IK 08)	5 Joule (IK 08)	5 Joule (IK 08)	5 Joule (IK 08)
-5°C ÷ +40°C	-5°C ÷ +40°C	-5°C ÷ +40°C	-5°C ÷ +40°C	-5°C ÷ +40°C	-5°C ÷ +40°C
IP31	IP31	IP31	IP31	IP31	IP31
69 W	80 W	89 W	93 W	110 W	120 W
YES	YES	YES	YES	YES	YES
Nipple flange	Nipple flange	Nipple flange	Nipple flange	Nipple flange	Nipple flange
YES	YES	YES	YES	YES	YES

Type	Weight in kg	Power loss in W
U53K	26	93
U53M	29	93
U53R4	26,5	93
U53TR4	22	93
U54E	33	120
U54K	32,5	120
U54R4	33,5	120
U61	14,5	50
U61R5	14,5	50
U61TE	12,5	50
U61TR5	12,5	50
U62	22	80
U62K	22	80
U62R5	22	80
U62TE	19	80

Type	Weight in kg	Power loss in W
U62TR5	19	80
U63E	31	110
U63K	30,5	110
U63R5	31,5	110
U63TR5	26	110
U64K	38	137
U72	25	89
U72K	25	89
U72R6	26	89
U72TR6	21,5	89
U73K	35	125
U73R6	35,5	125
U73TR6	28,5	125

> Maße in mm



# Technical details

## IP65 Europa Series

### Wall-mounting consumer units IP65 Europa Series

Code	12 724	12 728	12 732	12 733	12 734	12 735	12 738
	12 744	12 748	12 752	12 753	12 754	12 755	12 758
						12 736	
						12 756	
Number of modules	4	8	12	18	24	36	54
Colour	RAL 7035 grey	RAL 7035 grey	RAL 7035 grey	RAL 7035 grey	RAL 7035 grey	RAL 7035 grey	RAL 7035 grey
With transparent door	yes	yes	yes	yes	yes	yes	yes
With opaque door	yes	yes	yes	yes	yes	yes	yes
Double insulation	yes	yes	yes	yes	yes	yes	yes
Resistance to heat	GWT 650°C	GWT 650°C	GWT 650°C	GWT 650°C	GWT 650°C	GWT 650°C	GWT 650°C
Type of material	Thermo-plastic	Thermo-plastic	Thermo-plastic	Thermo-plastic	Thermo-plastic	Thermo-plastic	Thermo-plastic
Shock resistance	6 Joule (IK 08)	6 Joule (IK 08)	6 Joule (IK 08)	6 Joule (IK 08)	6 Joule (IK 08)	6 Joule (IK 08)	6 Joule (IK 08)
Installation temperature	25°C ÷ +60°C	25°C ÷ +60°C	25°C ÷ +60°C	25°C ÷ +60°C	25°C ÷ +60°C	25°C ÷ +60°C	25°C ÷ +60°C
Resistance to heat	up to +85°C	up to +85°C	up to +85°C	up to +85°C	up to +85°C	up to +85°C	up to +85°C
Protection degree	IP65	IP65	IP65	IP65	IP65	IP65	IP65
Max dissipation power*	15W	20W	30W	32W	34W	45W	56 W
Flange for direct branch	-	Cond. and trunk Ø 5÷35 mm	Cond. and trunk Ø 5÷35 mm	Cond. and trunk Ø 5÷35 mm	Cond. and trunk Ø 5÷35 mm	Cond. and trunk Ø 5÷35 mm	Cond. and trunk Ø 5÷35 mm
Extractable moulded-case	yes	yes	yes	yes	yes	yes	yes
Designed for moulded-case circuit breakers	yes	yes	yes	yes	yes	yes	yes
Designed for rapid cabling	-	Unifix L	Unifix L	Unifix L	Unifix L	Unifix L	Unifix L

\* Data concerning dissipative power have been obtained by following the instructions in CEI 23-49 Standard, with a temperature difference of Dt = 30°C.

### Reaction to chemical agents \*

IP65 Europa Series wall-mounting consumer units	Cold water	Hot water	Sulphuric acid 40%	Hydrochloric acid 35%	Acetic acid 10%	Benzole	Gasoline	Acetone	Ethyl alcohol	Ammonia liquid	Dichloromethane	Diesel oil-naphtha	Mineral oils and grases	Food oils and grases	Perchloroethylene	Trichloroethylene	Ethylether	Ozone	Toluene	Methanol	Spirits	Milk	Fruit juices	Fluoride hydrocarbons	Lye-washes	Cleansings	Water solution
	■	■	▲	▲	■	●	■	●	▲	■	●	■	■	■	●	●	●	■	●	▲	■	■	■	●	■	■	■

■ resistant   
 ▲ partially resistant   
 ● not resistant

\* Indications concerning the resistance of the products to chemical agents must be considered as an indication only, and refer to standard conditions (40°C, integral product).

## Possible configurations of terminal holders – terminal bars for consumer units

<b>For IP65 Europa consumer units</b>	<b>Terminal holder</b>	<b>Terminal bars</b>
<b>Number of modules</b>	<b>Code</b>	<b>Code x q.ty</b>
4	12 538	12 531 x 1
8	12 539	12 531 x 1
12, 24, 36 (12 mod. x 2 rows)	12 540	12 531 x 1
	12 540	12 531 x 2
	12 540	12 531 x 1 with 12 532 x 1
	12 540	12 532 x 1
	12 540	12 533 x 1
18, 36 (12 mod. x 2 rows), 54	12 540	12 534 x 1
	12 543	12 531 x 1
	12 543	12 531 x 2
	12 543	12 531 x 1 with 12 532 x 1
	12 543	12 531 x 1 with 12 533 x 1
	12 543	12 531 x 1 with 12 534 x 1
	12 543	12 531 x 1 with 12 535 x 1
	12 543	12 532 x 1
	12 543	12 532 x 2
	12 543	12 532 x 1 with 12 533 x 1
	12 543	12 532 x 1 with 12 534 x 1
	12 543	12 532 x 1 with 12 535 x 1
	12 543	12 533 x 1
	12 543	12 533 x 2
	12 543	12 533 x 1 with 12 534 x 1
	12 543	12 534 x 1
	12 543	12 534 x 2
12 543	12 535 x 1	

# Technical details

## IP40 wall mounting covers

### IP40 wall mounting covers

Code	M12422000 1SL2402A00	M12424000 1SL2404A00	M12426000 1SL2406A00
Number of modules	2	4	6
Colour	RAL 9016 white / RAL 7035 grey	RAL 9016 white / RAL 7035 grey	RAL 9016 white / RAL 7035 grey
Double insulation	NO	NO	NO
Resistance to heat	GWT 650°C	GWT 650°C	GWT 650°C
Type of material	Thermo-plastic	Thermo-plastic	Thermo-plastic
Shock resistance	6 Joule (IK 08)	6 Joule (IK 08)	6 Joule (IK 08)
Installation temperature	-25°C ÷ +80°C	-25°C ÷ +80°C	-25°C ÷ +80°C
Resistance to heat	up to +85°C	up to +85°C	up to +85°C
Protection degree	IP40	IP40	IP40
Cable holding system	YES	YES	YES
Designed for input	-	-	-
Extractable frame	-	-	-

6

### Reaction to chemical agents \*

	Cold water	Hot water	Sulphuric acid 40%	Hydrochloric acid 35%	Acetic acid 10%	Benzole	Gasoline	Acetone	Ethyl alcohol	Ammonia liquid	Dichloromethane	Diesel oil-naphta	Mineral oils and grases	Food oils and grases	Perchloroethylene	Trichloroethylene	Ethylether	Ozone	Toluene	Methanol	Spirits	Milk	Fruit juices	Fluoride hydrocarbons	Lye-washes	Cleansings	Water solution
IP40 wall-mounting covers	■	■	▲	▲	■	●	■	●	▲	■	●	■	■	■	●	●	●	■	●	▲	■	■	■	●	■	■	■

■ resistant    ▲ partially resistant    ● not resistant

\* Indications concerning the resistance of the products to chemical agents must be considered as an indication only, and refer to standard conditions (40 °C, integral product).

# Overall dimensions UK500 Series

## Wall box

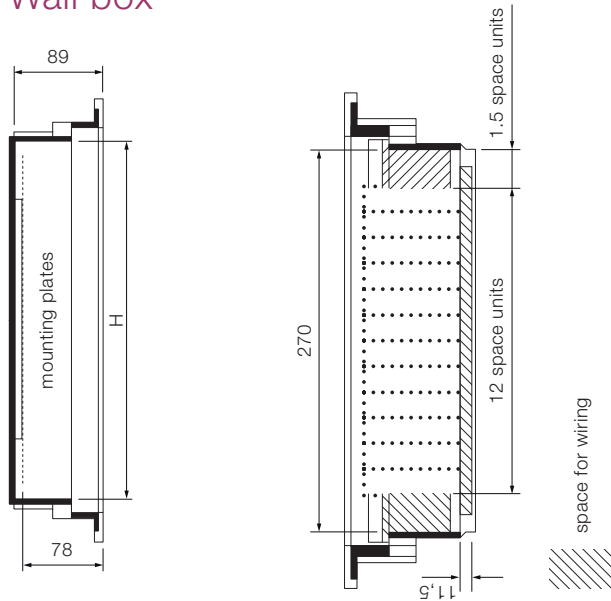

### Power loss and height DIN 43871 with over temperature $\Delta T$

Type	Power loss (W)			Height in mm
	$\Delta T$ 20 K	$\Delta T$ 25 K	$\Delta T$ 30 K	
UK51...	10.0	13.0	16.0	250
UK52...	11.5	15.0	19.0	375
UK53...	14.5	19.0	24.0	500
UK54...	16.5	21.5	27.0	625

## Trim frame

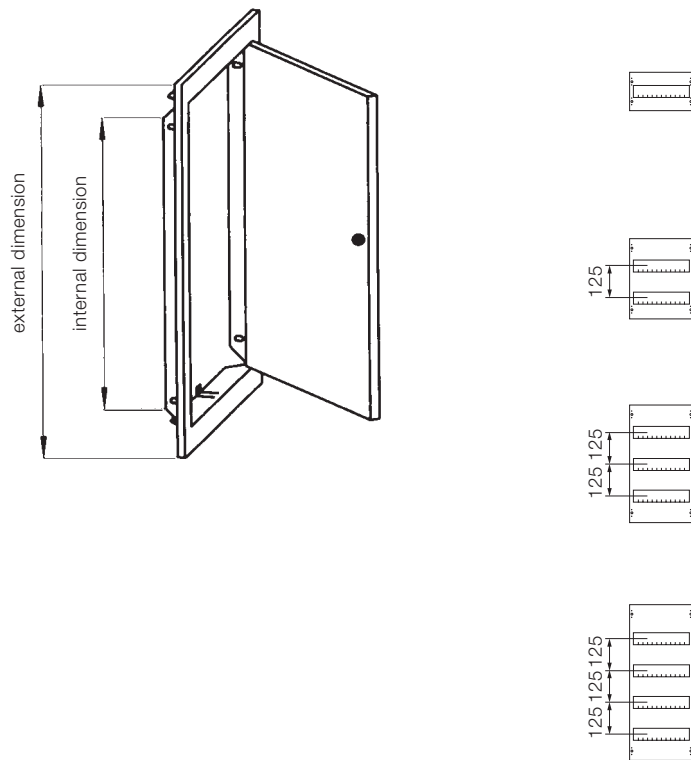

Type	Int. dimensions (H x W mm)	Ext. dimensions (H x W mm)	Weight in kg
BL510	282 x 297	352 x 367	1.5
BL516C	282 x 297	352 x 367	1.5
BL517C	282 x 297	352 x 367	1.5
BL517C	282 x 297	352 x 367	1.5
BL510K	282 x 297	352 x 367	1.5
BL520	407 x 297	477 x 367	1.9
BL526C	407 x 297	477 x 367	1.9
BL527C	407 x 297	477 x 367	1.9
BL528C	407 x 297	477 x 367	1.9
BL520K	407 x 297	477 x 367	1.9
BL530	532 x 297	602 x 367	2.3
BL536C	532 x 297	602 x 367	2.3
BL537C	532 x 297	602 x 367	2.3
BL538C	532 x 297	602 x 367	2.3
BL530K	532 x 297	602 x 367	2.3
BL530L	532 x 297	602 x 367	2.3
BL540	657 x 297	727 x 367	2.7
BL546C	657 x 297	727 x 367	2.7
BL547C	657 x 297	727 x 367	2.7
BL548C	657 x 297	727 x 367	2.7
BL540K	657 x 297	727 x 367	2.7
BL540L	657 x 297	727 x 367	2.7

# Overall dimensions UK500 Series

## Control panel

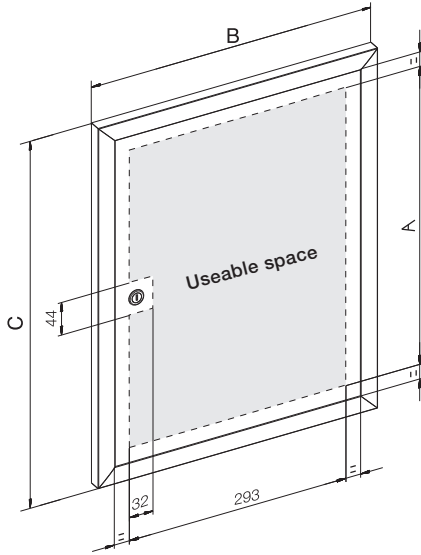

Type	A	B	C
FPT510	278	374	362
FPT520	403	374	487
FPT530	528	374	612

6

## Picture frame door

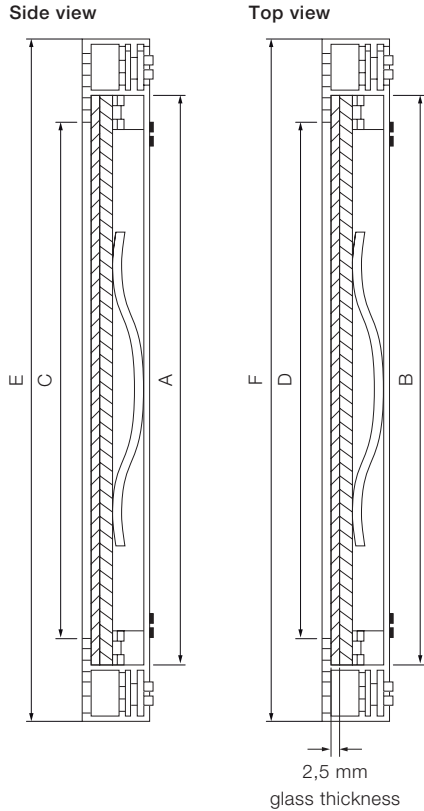

Type	A	B	C	D	E	F
BL521D	417	308	402	293	487	378
BL531D	542	308	526	293	612	378
BL527D	456	343	441	328	487	374
BL537D	581	343	566	328	612	374

# Overall dimensions Unibox Series

## Front view

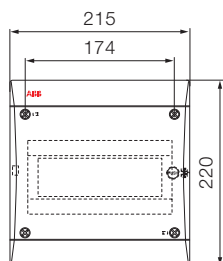

8 modules

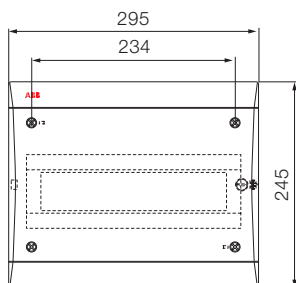

12 modules

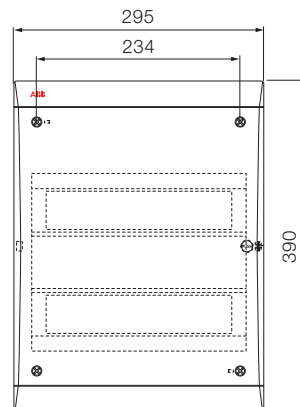

24 modules

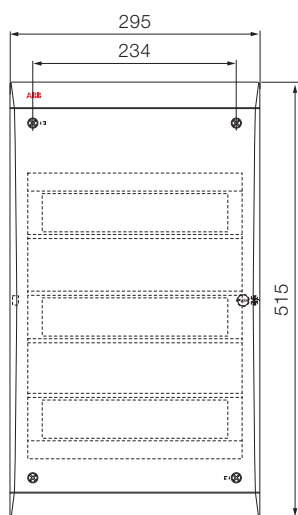

36 modules

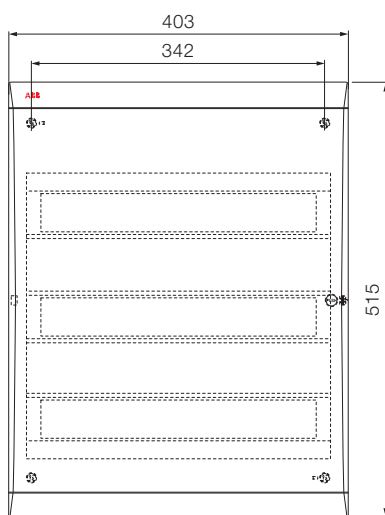

54 modules

## Side view

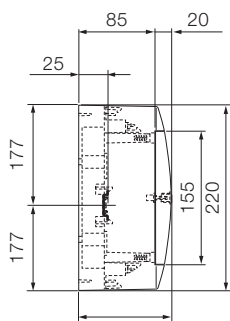

8 modules

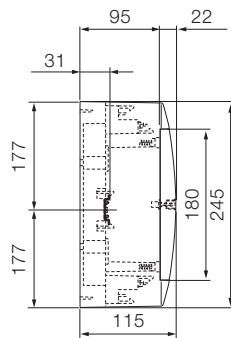

12 modules

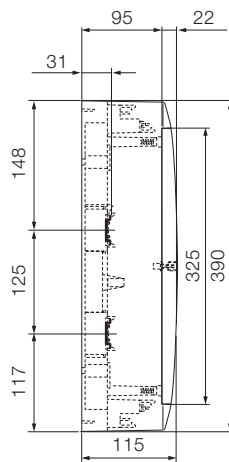

24 modules

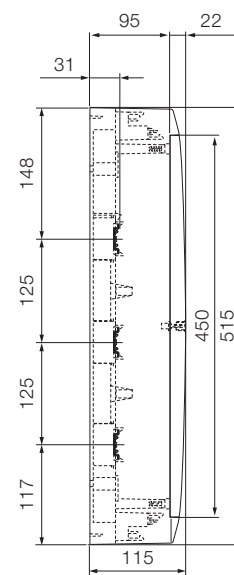

36-54 modules

# Overall dimensions Unibox Series

## Drilling sheets

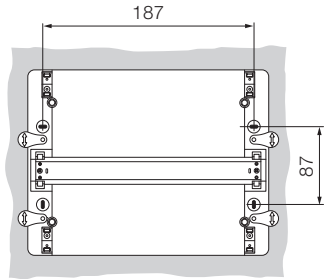

8 modules

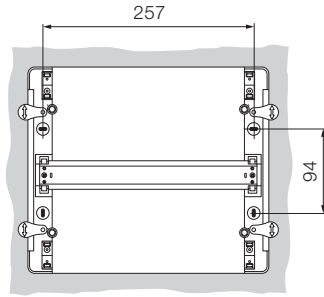

12 modules

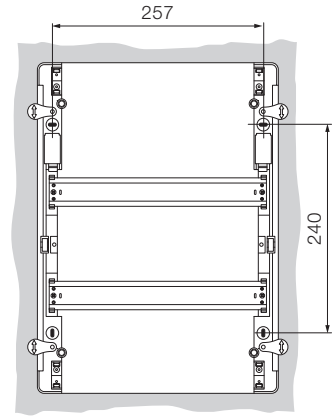

24 modules

6

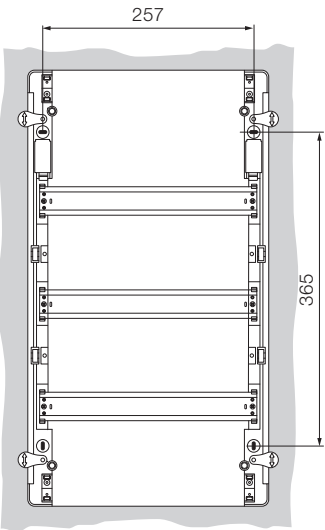

36 modules

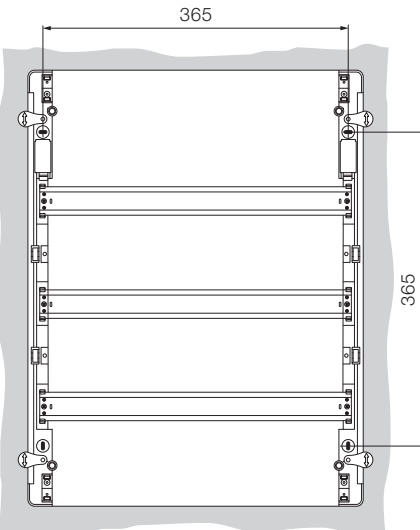

54 modules

Modules	Code
8 modules	12 238 – 12 258 – M12238000U - M12258000U
12 modules	12 242 – 12 262 – M12242000A - M12262000A
24 modules	12 244 – 12 264 – M12244000U - M12264000U
36 modules	12 246 – 12 266 – M12246000U - M12266000U
54 modules	12 247 – 12 267 – M12247000U - M12267000U



# Overall dimensions Alpha Series

## 1 row

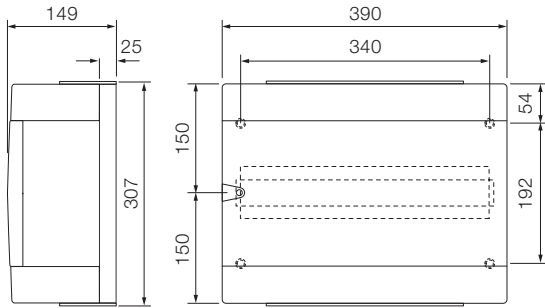

## 2 rows

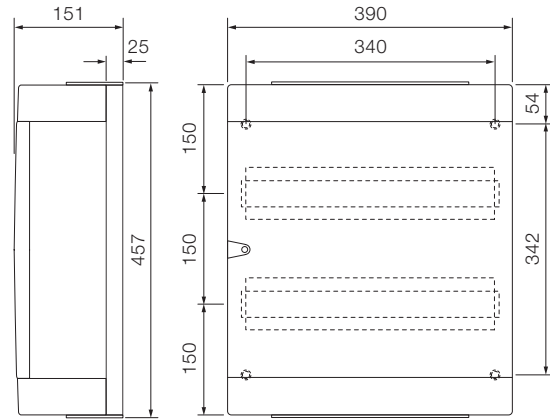

## 3 rows

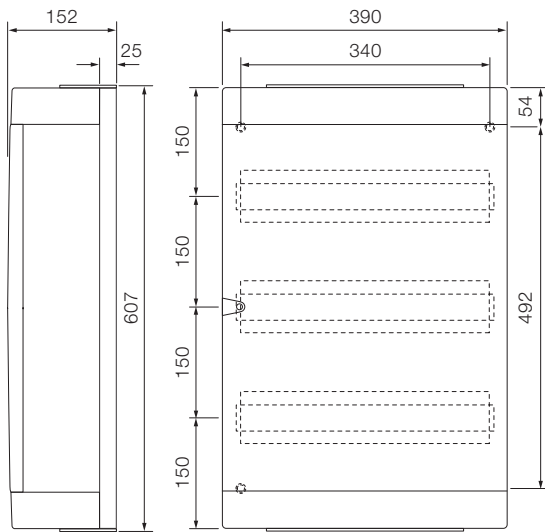

## 4 rows

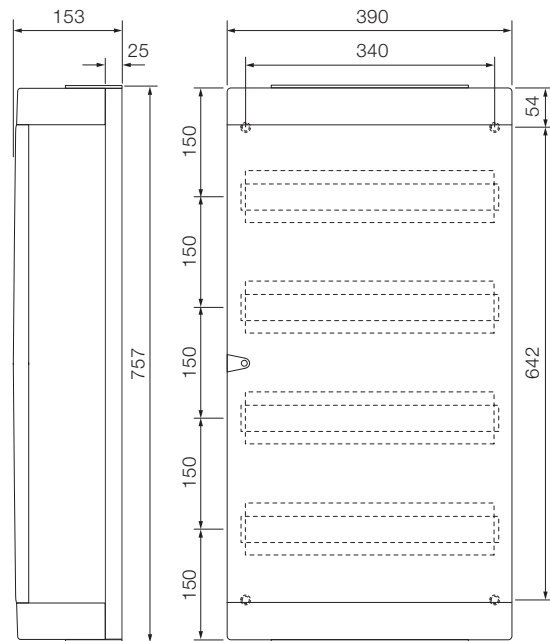

# Overall dimensions AT/U Series

## Wall-mounting with door, AT series

6

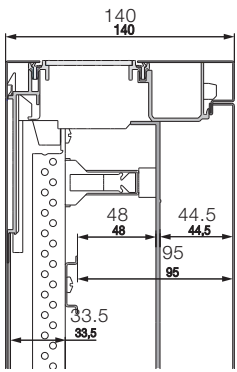

Compact distribution board panel

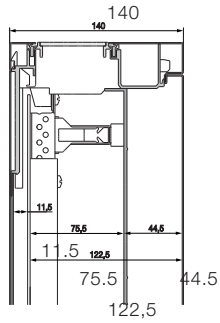

Panel with mounting plate

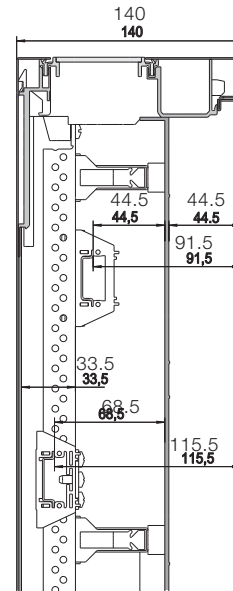

Panel for terminals

## Flush-mounting with door, U series

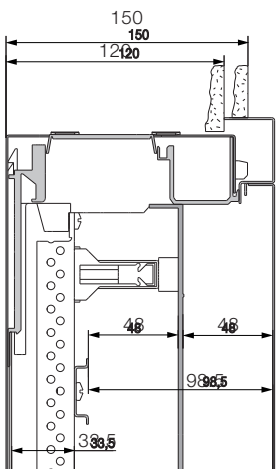

Compact distribution board panel

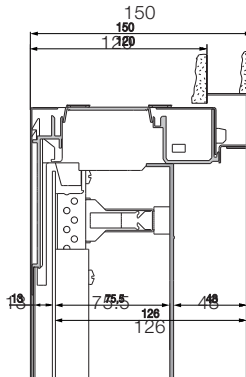

Panel with mounting plate

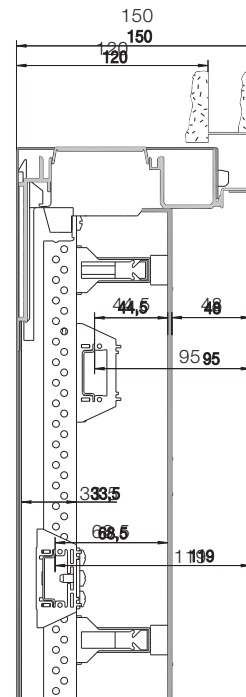

Panel for terminals

# Compact distribution boards

## Technical information

1. The cabinet is made of sheet steel (1 mm) and is powder-coated (RAL 9016). Its extraordinary stability is achieved by the profiled cabinet frame. Problem-free surface mounting is therefore also possible.
2. The protective insulation is guaranteed by an inserted plastic profile.
3. An additional plastic rear wall is inserted in order to maintain the protective insulation.
4. The door provides great stability thanks to its special shape in the hinge area and on the closing side.
5. The door can be readjusted with the special hinge.
6. The standard lock offers not only a new design but also secure closure, both as "standard" and as "security design".
7. The flange openings on top are closed ex-factory with the membrane flange.
8. The cabinet provides an optimum connection space thanks to the individual panel holders.
9. Prepunched knockouts are provided for inserting cables from the rear.

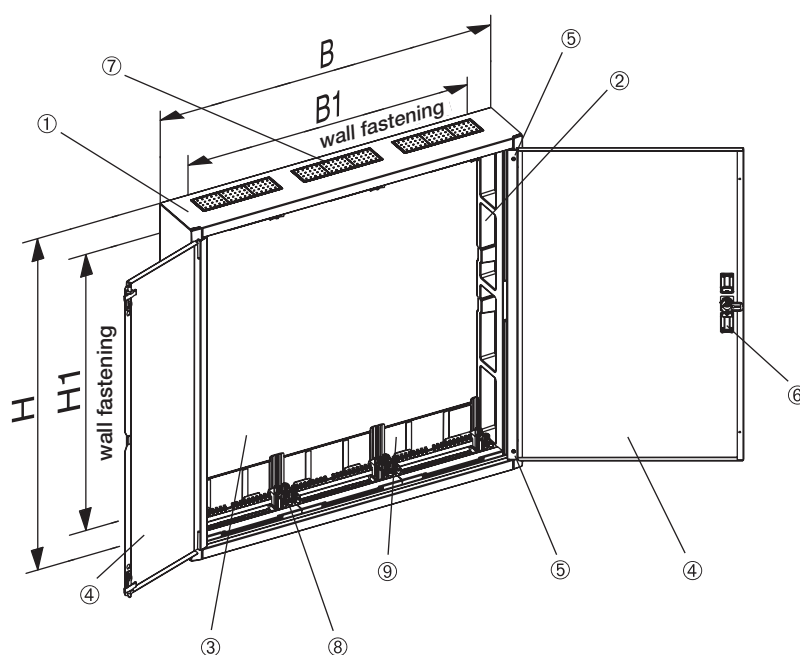

Type	H	W	H1	W1
AT22E	374	574	235	417
AT31	524	324	385	167
AT32, AT32TE, AT32R2, AT32TR2	524	574	385	417
AT41, AT41TE, AT41R3, AT41TR3	674	324	535	167
AT42, AT42TE, AT42M, AT42/2, AT42R3, AT42TR3	674	574	535	417
AT43, AT43R3, AT43TR3	674	824	535	667
AT51, AT51TE, AT51R4, AT51TR4	824	324	685	167
AT52, AT52TE, AT52K, AT52/2, AT52R4, AT52TR4	824	574	685	417
AT53, AT53M, AT53K, AT53R4, AT53TR4	824	824	685	667
AT54K, AK54E, AT54R4	824	1074	685	917
AT61, AT61TE, AT61R5, AT61TR5	974	324	835	167
AT62, AT62TE, AT62K, AT62R5, AT62TR5	974	574	835	417
AT63E, AT63K, AT63R5, AT63TR5	974	824	835	667
AT64K	974	1074	835	917
AT72, AT72K, AT72R6, AT72TR6	1124	574	985	417
AT73K, AT73R6, AT73TR6	1124	824	985	667

Dimensions in mm

# Overall dimensions IP65 Europa Series

## Front view

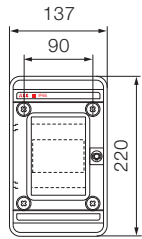

4 modules

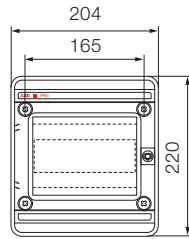

8 modules

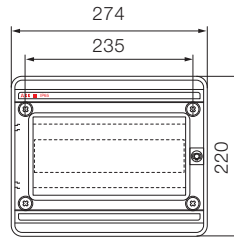

12 modules

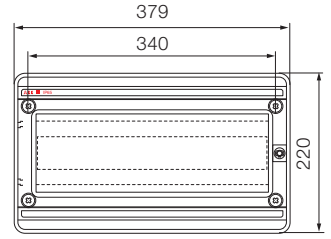

18 modules

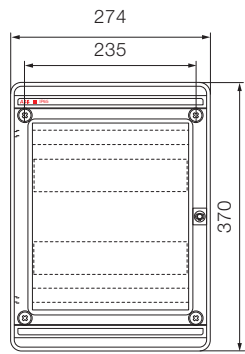

24 modules

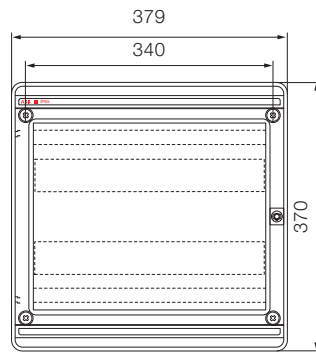

36 modules

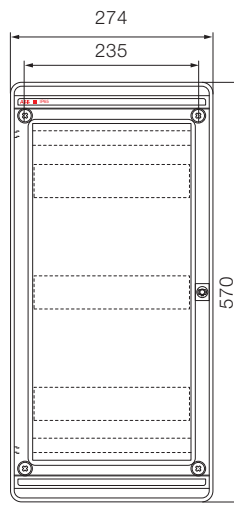

36 modules

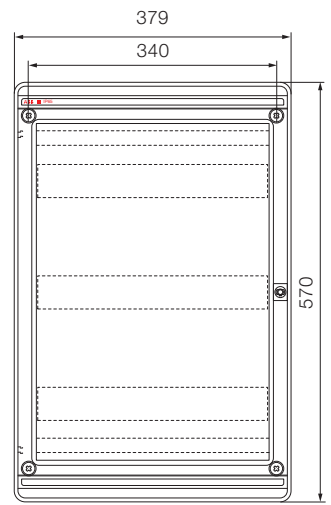

54 modules

6

## Side view

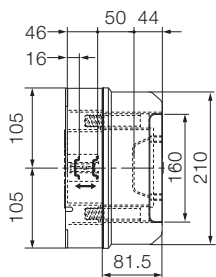

4-8-12 modules

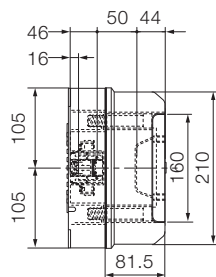

18 modules

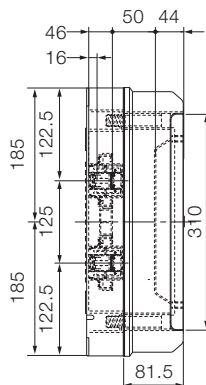

24 modules

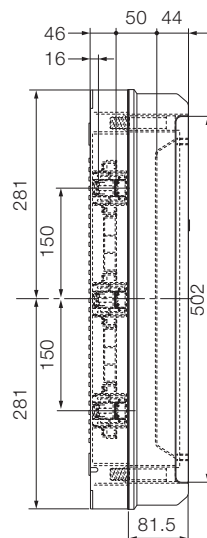

36-54 modules

## Drilling sheets

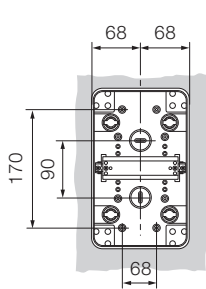

4 modules

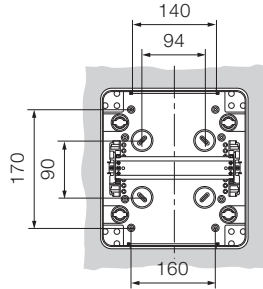

8 modules

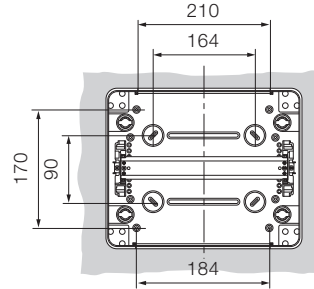

12 modules

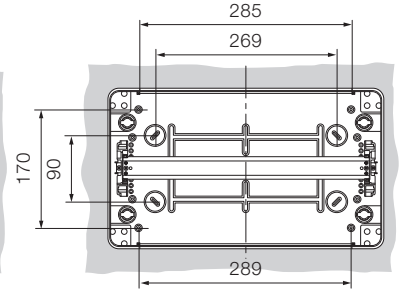

18 modules

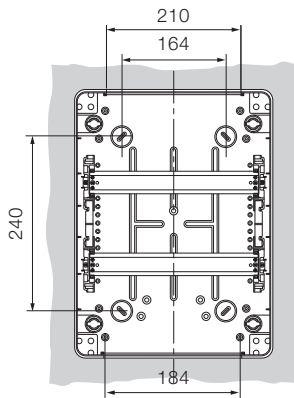

24 modules

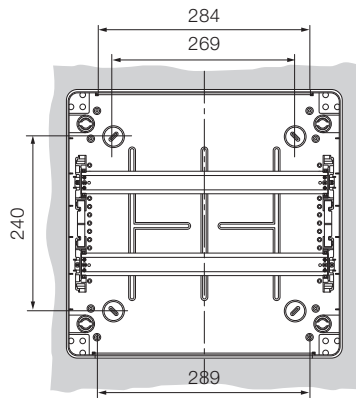

36 modules

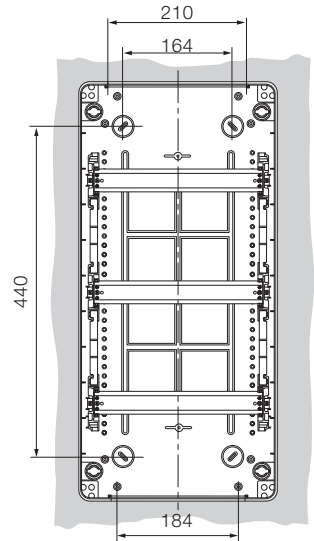

36 modules

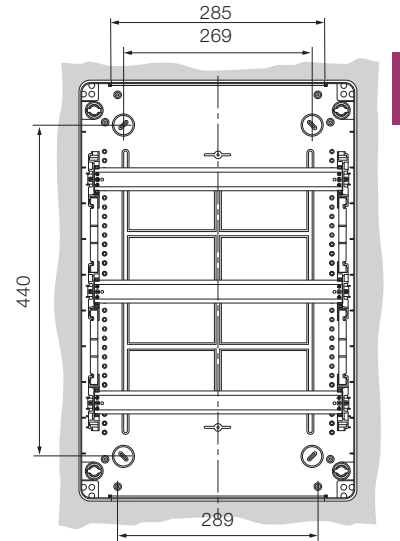

54 modules

Modules	Code
4 modules	12 724 – 12 744
8 modules	12 728 – 12 748
12 modules	12 732 – 12 752
18 modules	12 733 – 12 753
24 modules	12 734 – 12 754
36 modules (18x2)	12 735 – 12 755
36 modules (12x3)	12 736 – 12 756
54 modules	12 738 – 12 758

# Overall dimensions IP40 Wall-mounting covers

## Front view

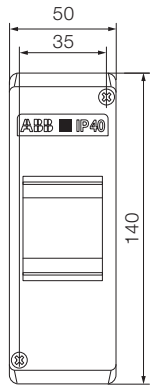

2 modules

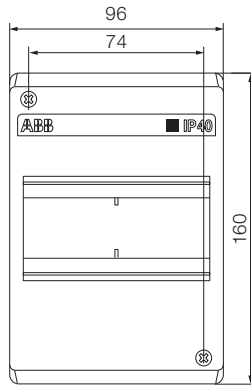

4 modules

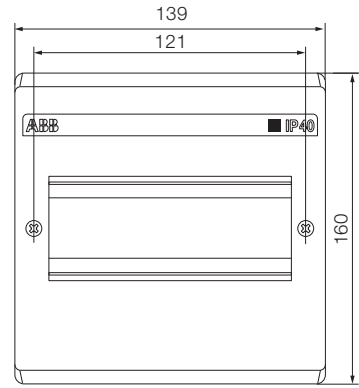

6 modules

6

## Side view

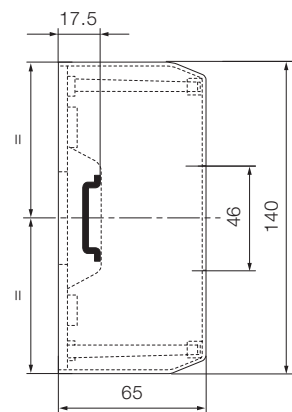

2 modules

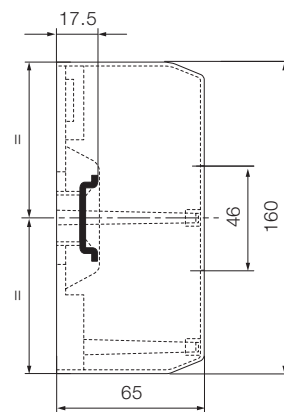

4-6 modules

Modules	Code
2 modules	1SL2402A00 – 12 422
4 modules	1SL2404A00 – 12 424
6 modules	1SL2406A00 – 12 426

## Drilling sheets

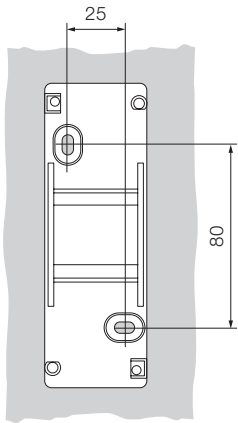

2 modules

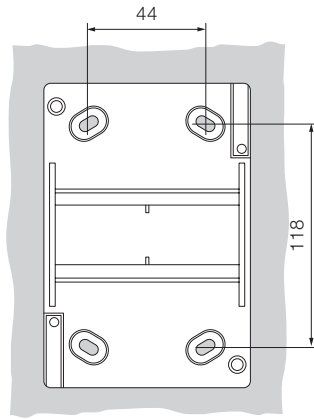

4 modules

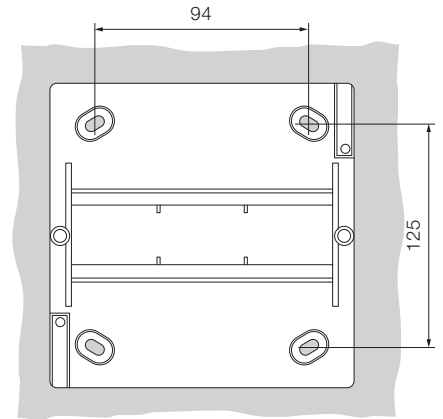

6 modules



# Overall dimensions IP44, IP55 and IP65 junction boxes

## Front view

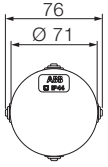

00 800  
1SL0900A00

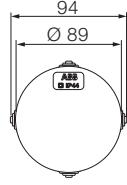

00 802  
1SL0901A00

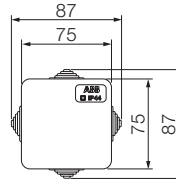

00 808  
1SL0902A00

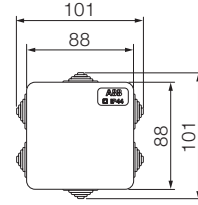

00 810  
1SL0903A00

6

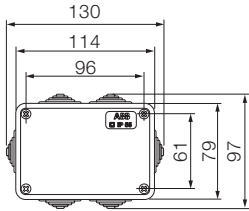

00 820  
00 850  
1SL0820A00  
1SL0850A00  
1SL0905A00  
1SL0909A00  
1SL0920A00  
1SL0950A00

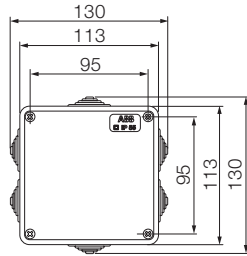

00 816  
00 821  
00 846  
00 851  
1SL0816A00  
1SL0821A00  
1SL0846A00  
1SL0851A00  
1SL0904A00  
1SL0906A00  
1SL0908A00  
1SL0910A00  
1SL0916A00  
1SL0921A00  
1SL0946A00  
1SL0951A00

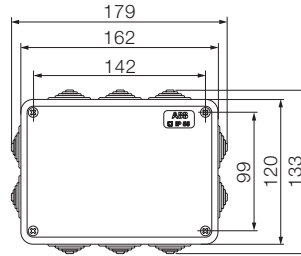

00 822  
00 852  
00 872  
1SL0822A00  
1SL0852A00  
1SL0872A00  
1SL0907A00  
1SL0911A00  
1SL0912A00  
1SL0922A00  
1SL0972A00  
1SL0985A00

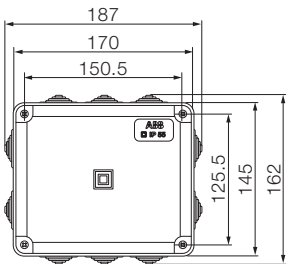

1SL0824A00  
1SL0830A00  
1SL0854A00  
1SL0860A00  
1SL0874A00  
1SL0880A00  
1SL0924A00  
1SL0930A00  
1SL0954A00  
1SL0960A00  
1SL0974A00  
1SL0980A00

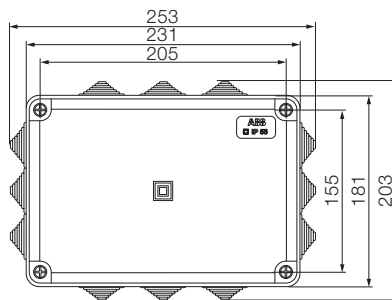

1SL0826A00  
1SL0832A00  
1SL0856A00  
1SL0862A00  
1SL0876A00  
1SL0884A00  
1SL0926A00  
1SL0932A00  
1SL0956A00  
1SL0962A00  
1SL0976A00  
1SL0984A00

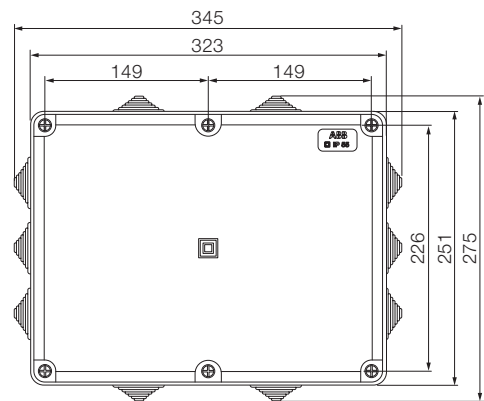

1SL0828A00  
1SL0834A00  
1SL0858A00  
1SL0864A00  
1SL0878A00  
1SL0884A00  
1SL0928A00  
1SL0934A00  
1SL0958A00  
1SL0964A00  
1SL0978A00  
1SL0984A00

## Side view

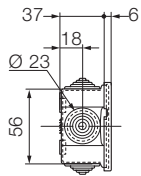

00 800  
1SL0900A00

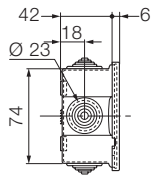

00 802  
1SL0901A00

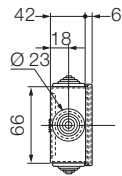

00 808  
1SL0902A00

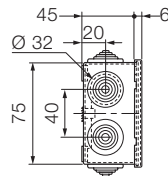

00 810  
1SL0903A00

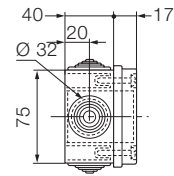

00 820  
00 850  
1SL0820A00  
1SL0850A00  
1SL0905A00  
1SL0909A00  
1SL0920A00  
1SL0950A00

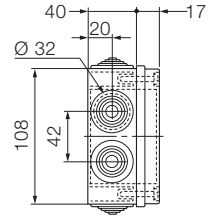

00 816  
00 846  
1SL0816A00  
1SL0846A00  
1SL0904A00  
1SL0908A00  
1SL0916A00  
1SL0921A00  
1SL0946A00

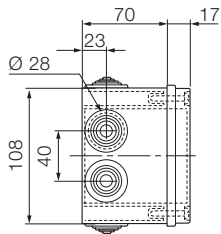

00 821  
00 851  
1SL0821A00  
1SL0851A00  
1SL0906A00  
1SL0910A00  
1SL0921A00  
1SL0951A00

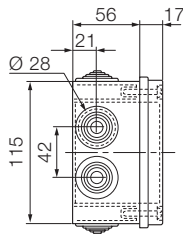

00 822  
00 852  
00 872  
1SL0822A00  
1SL0852A00  
1SL0872A00  
1SL0907A00  
1SL0911A00  
1SL0912A00  
1SL0922A00  
1SL0952A00  
1SL0972A00

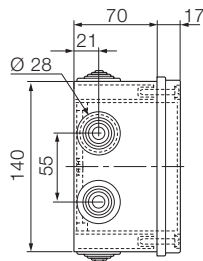

1SL0824A00  
1SL0854A00  
1SL0874A00  
1SL0924A00  
1SL0954A00  
1SL0974A00

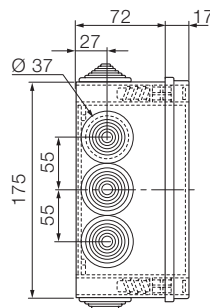

1SL0826A00  
1SL0856A00  
1SL0876A00  
1SL0926A00  
1SL0956A00  
1SL0976A00

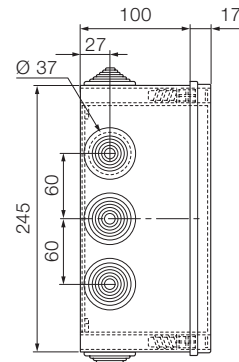

1SL0828A00  
1SL0858A00  
1SL0878A00  
1SL0928A00  
1SL0958A00  
1SL0978A00

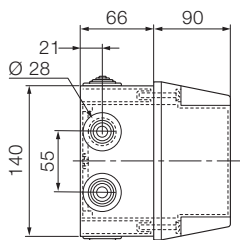

1SL0830A00  
1SL0860A00  
1SL0880A00  
1SL0930A00  
1SL0960A00  
1SL0980A00

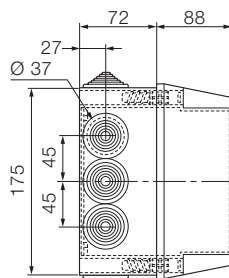

1SL0832A00  
1SL0862A00  
1SL0882A00  
1SL0932A00  
1SL0962A00  
1SL0982A00

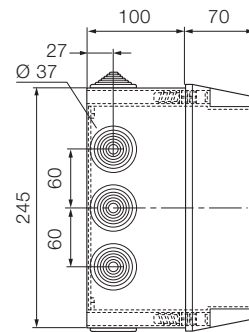

1SL0834A00  
1SL0864A00  
1SL0884A00  
1SL0934A00  
1SL0964A00  
1SL0984A00

# Overall dimensions IP44, IP55 and IP65 junction boxes

## Drilling sheets and internal dimensions

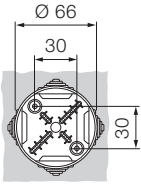

00 800  
00 581  
1SL0900A00  
1SL0910A00

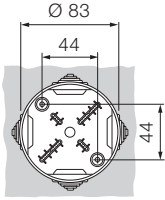

00 802  
1SL0901A00

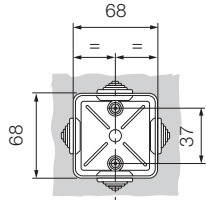

00 808  
1SL0902A00

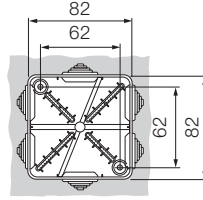

00 810  
1SL0903A00

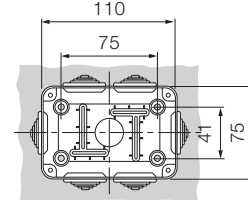

00 820  
00 850  
1SL0820A00  
1SL0850A00

1SL0905A00  
1SL0909A00  
1SL0920A00  
1SL0950A00

6

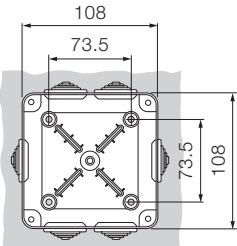

00 816  
00 846  
1SL0816A00  
1SL0846A00

1SL0904A00  
1SL0908A00  
1SL0916A00  
1SL0946A00

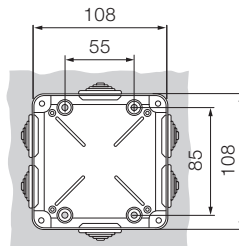

00 821  
00 851  
1SL0821A00  
1SL0851A00

1SL0906A00  
1SL0910A00  
1SL0921A00  
1SL0951A00

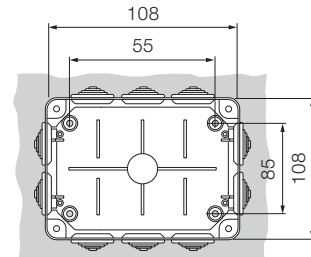

00 822  
00 852  
00 872  
1SL0822A00  
1SL0852A00  
1SL0872A00

1SL0907A00  
1SL0911A00  
1SL0912A00  
1SL0922A00  
1SL0952A00  
1SL0972A00

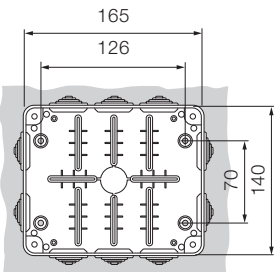

1SL0830A00  
1SL0824A00  
1SL0874A00  
1SL0854A00  
1SL0860A00  
1SL0880A00

1SL0924A00  
1SL0930A00  
1SL0954A00  
1SL0960A00  
1SL0974A00  
1SL0980A00

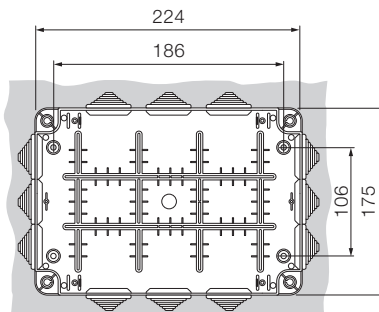

1SL0826A00  
1SL0832A00  
1SL0876A00  
1SL0856A00  
1SL0862A00  
1SL0884A00

1SL0926A00  
1SL0932A00  
1SL0956A00  
1SL0962A00  
1SL0976A00  
1SL0984A00

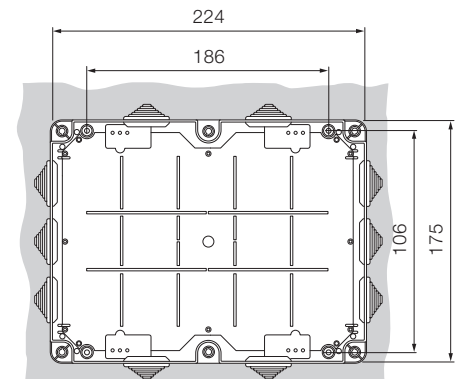

1SL0828A00  
1SL0834A00  
1SL0878A00  
1SL0858A00  
1SL0864A00  
1SL0884A00

1SL0928A00  
1SL0934A00  
1SL0958A00  
1SL0964A00  
1SL0978A00  
1SL0984A00



# Contacts

[www.abb.com](http://www.abb.com)



The data and illustrations are not binding. We reserve the right to modify the contents of this document on the basis of technical development of the products, without prior notice.

Copyright 2013 ABB. All right reserved.

2CSC400030D0202 - 12/2012