



















Ordering information

I/O cables

Shape	PLC connection	Terminal connection	Length in cm										Wiring	Order code		
			30	50	75	100	150	200	250	300	400	500				
	FCN24	MIL20	-	■	-	■	-	■	-	■	-	■	-	■	Straight	XW2Z-[...]AD-L
		Open ends	-	-	-	■	-	■	-	■	-	■	-	■	n. a.	XW2Z-[...]AL-L
	FCN40	MIL20 × 2	-	-	-	■	■	■	-	■	■	■	-	■	Straight	XW2Z-[...]BH-L01
			Reverse	-	-	-	■	■	■	-	■	■	■	-	■	XW2Z-[...]BH-L02
		MIL40	-	■	-	■	■	■	-	■	-	■	-	■	Straight	XW2Z-[...]BF-L
	Open ends	-	-	-	■	-	■	-	■	-	■	-	■	n. a.	XW2Z-[...]BN-L	
	FCN56	MIL20 × 3	-	-	-	-	■	■	-	■	-	-	-	Straight	XW2Z-[...]CJ-L01	
			Reverse	-	-	-	-	■	■	-	■	-	-	-	XW2Z-[...]CJ-L02	
		MIL20 + MIL40	-	-	-	-	■	■	-	-	-	-	-	Straight	XW2Z-[...]CK-L01	
	Reverse	-	-	-	-	■	■	-	-	-	-	-	XW2Z-[...]CK-L02			
	MIL60	-	-	-	■	-	■	-	■	-	-	-	Straight	XW2Z-[...]CG-L		
	MIL20	MIL20	-	■	-	■	-	■	-	-	-	-	Straight	XW2Z-[...]DD-L		
		Open ends	-	■	-	■	■	■	-	■	-	■	-	n. a.	XW2Z-[...]DL-L	
		Fork terminals	-	■	-	■	■	■	-	■	-	■	-	n. a.	XW2Z-[...]DM-L	
	MIL34	MIL34	-	-	-	-	-	■	-	-	-	-	Straight	XW2Z-[...]EE-L		
	MIL40	MIL20 × 2	-	-	■	■	-	■	-	■	-	■	Reverse	XW2Z-[...]FH-L01		
			Straight	-	-	■	■	-	■	-	■	-	■	XW2Z-[...]FH-L02		
		MIL40	■	■	-	■	■	■	-	■	-	■	Straight	XW2Z-[...]FF-L		
	Open ends	-	-	-	■	■	■	■	■	-	■	-	n. a.	XW2Z-[...]FN-L		

Note: For [...] fill in the 4-digit length in cm

I/O cables XW2Z

XW2Z-_AD-L

PLC connection	Terminal connection	Wiring	Length in cm (L)							Order code			
			30	50	75	100	150	200	250		300	400	500
24-pin FCN Connector	20-pin MIL Connector	Straight	-	■	-	-	-	-	-	-	-	-	XW2Z-0050AD-L
			-	-	■	-	-	-	-	-	-	-	XW2Z-0100AD-L
			-	-	-	-	■	-	-	-	-	-	XW2Z-0200AD-L
			-	-	-	-	-	-	■	-	-	-	XW2Z-0300AD-L

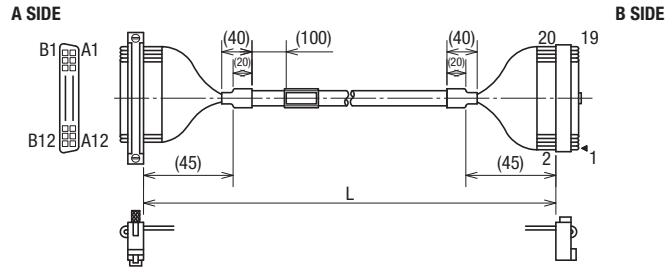

XW2Z-_AL-L

PLC connection	Terminal connection	Wiring	Length in cm (L)							Order code			
			30	50	75	100	150	200	250		300	400	500
24-pin FCN	Loose Wires	Straight	-	-	-	■	-	-	-	-	-	-	XW2Z-0100AL-L
			-	-	-	-	■	-	-	-	-	-	XW2Z-0200AL-L
			-	-	-	-	-	-	■	-	-	-	XW2Z-0300AL-L

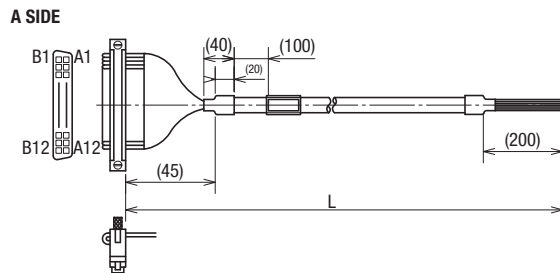

XW2Z-_BH-L01

PLC connection	Terminal connection	Wiring	Length in cm (L1)					Length in cm (L2)					Order code		
			100	150	200	300	400	500	75	125	175	275		375	475
40-pin FCN	Two 20-pin MIL	Straight	■	-	-	-	-	-	■	-	-	-	-	-	XW2Z-0100BH-L01
			-	■	-	-	-	-	-	■	-	-	-	-	XW2Z-0150BH-L01
			-	-	■	-	-	-	-	-	■	-	-	-	XW2Z-0200BH-L01
			-	-	-	■	-	-	-	-	-	■	-	-	XW2Z-0300BH-L01
			-	-	-	-	■	-	-	-	-	-	■	-	XW2Z-0400BH-L01
			-	-	-	-	-	■	-	-	-	-	-	■	XW2Z-0500BH-L01

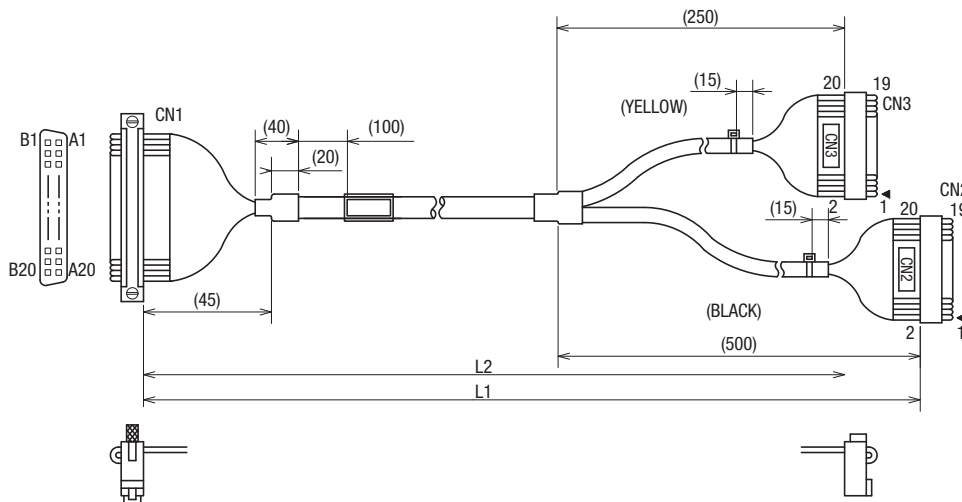

XW2Z-_BH-L02

PLC connection	Terminal connection	Wiring	Length in cm (L1)					Length in cm (L2)					Order code		
			100	150	200	300	400	500	75	125	175	275		375	475
40-pin FCN	Two 20-pin MIL	Reverse	■	-	-	-	-	-	■	-	-	-	-	-	XW2Z-0100BH-L02
			-	■	-	-	-	-	-	■	-	-	-	-	XW2Z-0150BH-L02
			-	-	■	-	-	-	-	-	■	-	-	-	XW2Z-0200BH-L02
			-	-	-	■	-	-	-	-	-	■	-	-	XW2Z-0300BH-L02
			-	-	-	-	■	-	-	-	-	-	■	-	XW2Z-0400BH-L02
			-	-	-	-	-	■	-	-	-	-	-	■	XW2Z-0500BH-L02

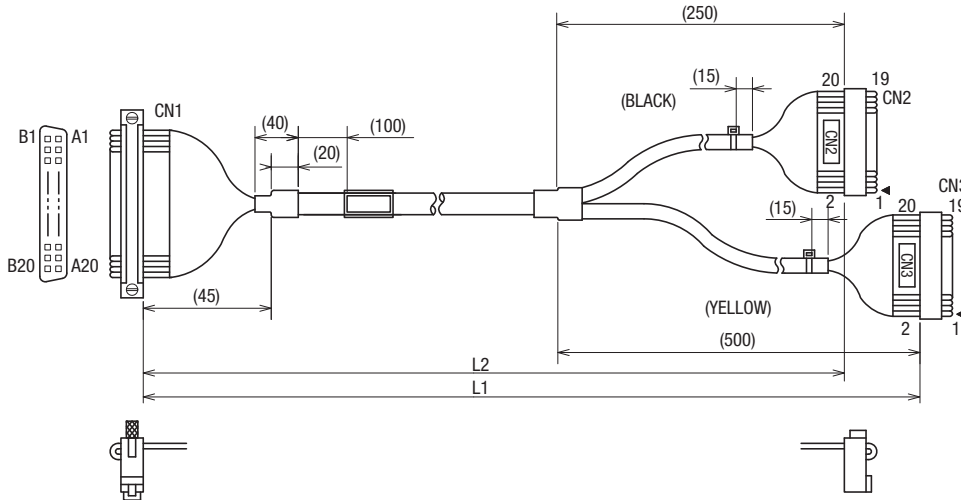

XW2Z-_BF-L

PLC connection	Terminal connection	Wiring	Length in cm (L)										Order code	
			30	50	75	100	150	200	250	300	400	500		
40-pin FCN	40-pin MIL	Straight	-	■	-	-	-	-	-	-	-	-	-	XW2Z-0050BF-L
			-	-	-	■	-	-	-	-	-	-	-	XW2Z-0100BF-L
			-	-	-	-	■	-	-	-	-	-	-	XW2Z-0150BF-L
			-	-	-	-	-	■	-	-	-	-	-	XW2Z-0200BF-L
			-	-	-	-	-	-	-	■	-	-	-	XW2Z-0300BF-L
			-	-	-	-	-	-	-	-	-	■	-	XW2Z-0500BF-L

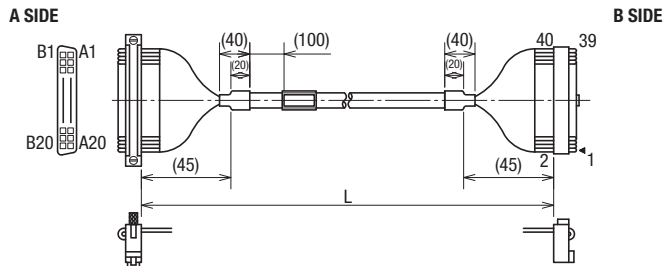

XW2Z-_BN-L

PLC connection	Terminal connection	Wiring	Length in cm (L)										Order code
			30	50	75	100	150	200	250	300	400	500	
40-pin FCN	Loose Wires	Straight	-	-	-	■	-	-	-	-	-	-	XW2Z-0100BN-L
			-	-	-	-	■	-	-	-	-	-	XW2Z-0200BN-L
			-	-	-	-	-	■	-	-	-	-	XW2Z-0300BN-L
			-	-	-	-	-	-	■	-	-	-	XW2Z-0500BN-L
			-	-	-	-	-	-	-	-	-	■	-

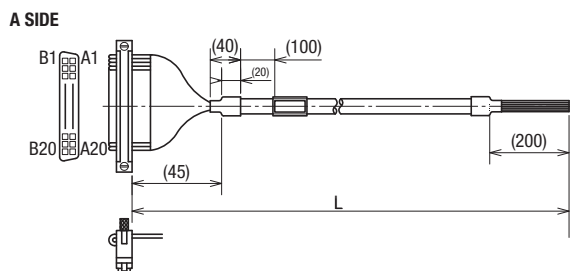

I/O cables

I/O cables and terminal blocks

XW2Z- _CJ-L01

PLC connection	Terminal connection	Wiring	Length in cm (L1)					Length in cm (L2)					Order code		
			100	150	200	300	400	500	75	125	175	275		375	475
56-pin FCN	Three 20-pin MIL	Straight	-	■	-	-	-	-	-	■	-	-	-	-	XW2Z-0150CJ-L01
			-	-	■	-	-	-	-	-	■	-	-	-	XW2Z-0200CJ-L01
			-	-	-	■	-	-	-	-	-	■	-	-	XW2Z-0300CJ-L01

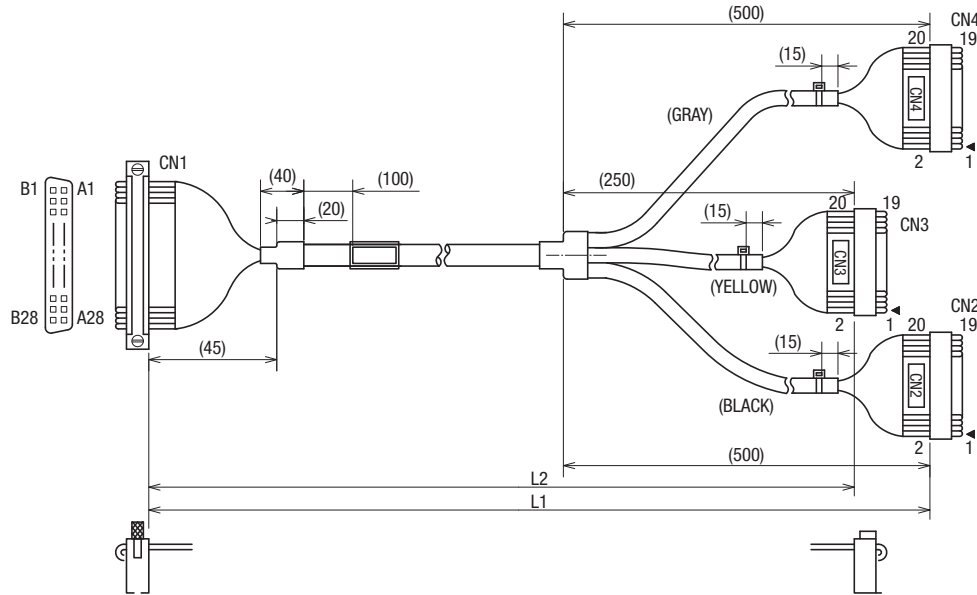

XW2Z- _CJ-L02

PLC connection	Terminal connection	Wiring	Length in cm (L1)					Length in cm (L2)					Length in cm (L3)					Order code			
			100	150	200	300	400	500	75	125	175	275	375	475	50	100	150		250	300	
56-pin FCN	Three 20-pin MIL	Reverse	-	■	-	-	-	-	-	■	-	-	-	-	-	■	-	-	-	XW2Z-0150CJ-L02	
			-	-	■	-	-	-	-	-	-	■	-	-	-	-	-	■	-	-	XW2Z-0200CJ-L02
			-	-	-	■	-	-	-	-	-	-	-	■	-	-	-	-	■	-	XW2Z-0300CJ-L02

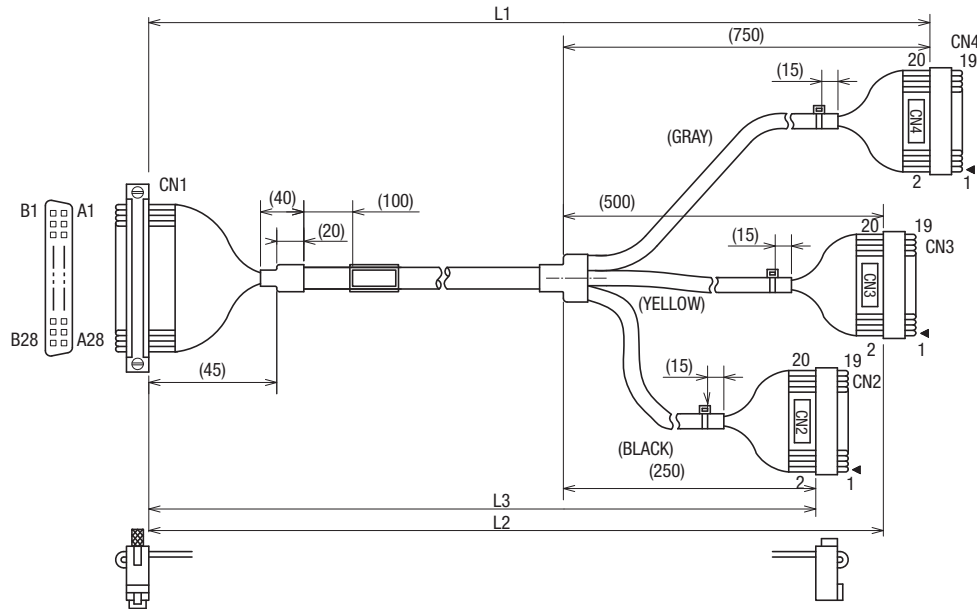

XW2Z-CK-L0

PLC connection	Terminal connection	Wiring	Length in cm (L1)					Length in cm (L2)					Order code	
			100	150	200	300	400	500	75	125	175	275		375
56-pin	40-pin MIL	Straight	-	■	-	-	-	-	■	-	-	-	-	XW2Z-0150CK-L01
		Reverse	-	■	-	-	-	-	■	-	-	-	-	XW2Z-0150CK-L02
		Straight	-	-	■	-	-	-	-	■	-	-	-	XW2Z-0200CK-L01
		Reverse	-	-	■	-	-	-	-	■	-	-	-	XW2Z-0200CK-L02

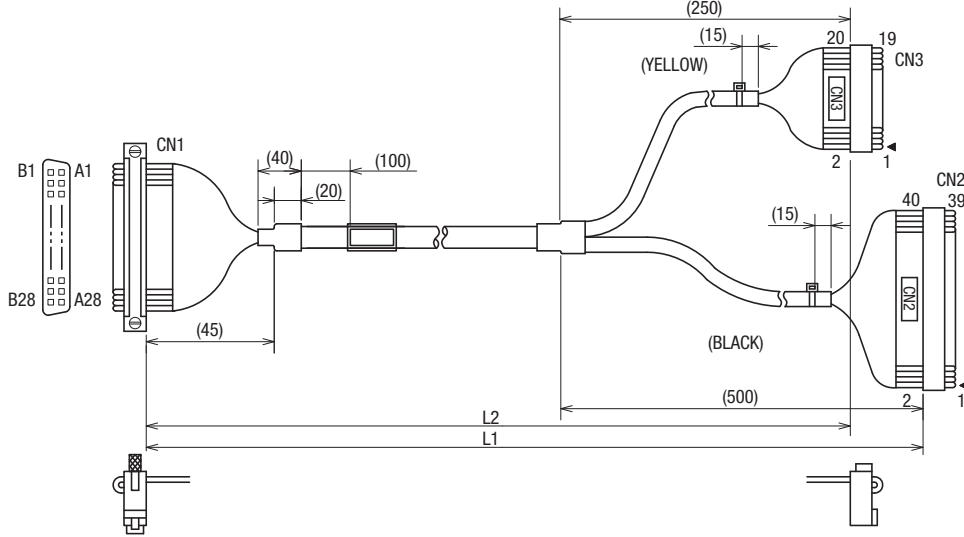

XW2Z-CG-L

PLC connection	Terminal connection	Wiring	Length in cm (L)								Order code		
			30	50	75	100	150	200	250	300		400	500
56-pin FCN	60-pin MIL	Straight	-	-	-	■	-	-	-	-	-	-	XW2Z-0100CG-L
			-	-	-	-	-	■	-	-	-	-	XW2Z-0200CG-L
			-	-	-	-	-	-	-	■	-	-	-

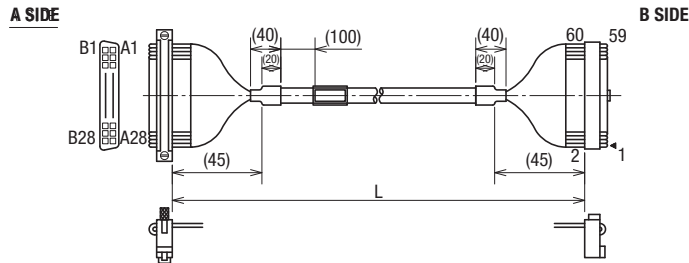

XW2Z-DD-L

PLC connection	Terminal connection	Wiring	Length in cm (L)								Order code		
			30	50	75	100	150	200	250	300		400	500
20-pin MIL	20-pin MIL	Straight	-	■	-	-	-	-	-	-	-	-	XW2Z-0050DD-L
			-	-	-	■	-	-	-	-	-	-	XW2Z-0100DD-L
			-	-	-	-	-	■	-	-	-	-	-

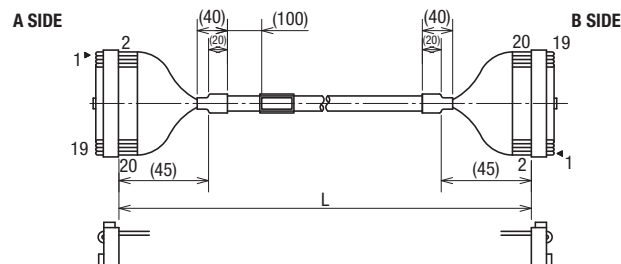

XW2Z-_DL-L

PLC connection	Terminal connection	Wiring	Length in cm (L1)										Order code	
			30	50	75	100	150	200	250	300	400	500		
20-pin MIL	Loose Wires	Straight	-	■	-	-	-	-	-	-	-	-	-	XW2Z-0050DL-L
			-	-	-	■	-	-	-	-	-	-	-	XW2Z-0100DL-L
			-	-	-	-	■	-	-	-	-	-	-	XW2Z-0150DL-L
			-	-	-	-	-	■	-	-	-	-	-	XW2Z-0200DL-L
			-	-	-	-	-	-	■	-	-	-	-	XW2Z-0300DL-L
			-	-	-	-	-	-	-	■	-	-	-	XW2Z-0500DL-L

A SIDE

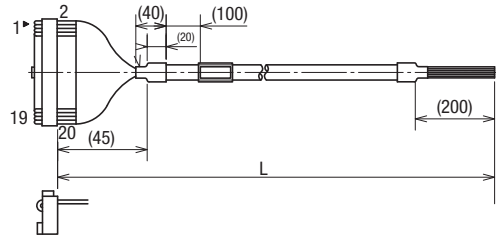

XW2Z-_DM-L

PLC connection	Terminal connection	Wiring	Length in cm (L1)										Order code	
			30	50	75	100	150	200	250	300	400	500		
20-pin MIL	Loose Wires with Fork Terminals	Straight	-	■	-	-	-	-	-	-	-	-	-	XW2Z-0050DM-L
			-	-	-	■	-	-	-	-	-	-	-	XW2Z-0100DM-L
			-	-	-	-	■	-	-	-	-	-	-	XW2Z-0150DM-L
			-	-	-	-	-	■	-	-	-	-	-	XW2Z-0200DM-L
			-	-	-	-	-	-	■	-	-	-	-	XW2Z-0300DM-L
			-	-	-	-	-	-	-	■	-	-	-	XW2Z-0500DM-L

A SIDE

B SIDE

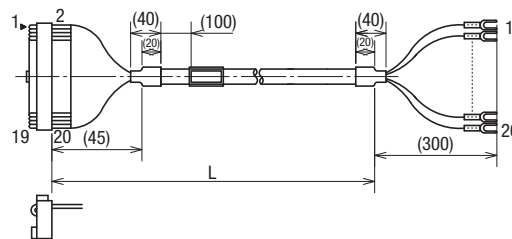

XW2Z-0200EE-L

PLC connection	Terminal connection	Wiring	Length in cm (L1)										Order code	
			30	50	75	100	150	200	250	300	400	500		
34-pin MIL	34-pin MIL	Straight	-	-	-	-	-	■	-	-	-	-	-	XW2Z-0200EE-L

A SIDE

B SIDE

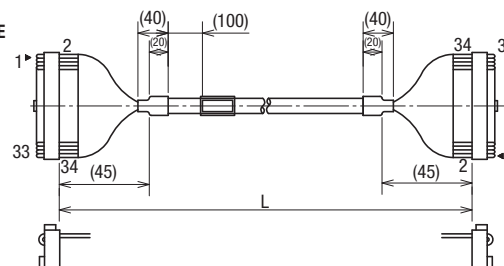

XW2Z-_FH-L01

PLC connection	Terminal connection	Wiring	Length in cm (L1)					Length in cm (L2)					Order code		
			75	100	200	300	400	500	50	75	175	275		375	475
40-pin MIL	Two 20-pin MIL	Reverse	■	-	-	-	-	-	■	-	-	-	-	-	XW2Z-0075FH-L01
			-	■	-	-	-	-	-	■	-	-	-	-	XW2Z-0100FH-L01
			-	-	■	-	-	-	-	-	■	-	-	-	XW2Z-0200FH-L01
			-	-	-	■	-	-	-	-	-	■	-	-	XW2Z-0300FH-L01
			-	-	-	-	-	■	-	-	-	-	-	■	XW2Z-0500FH-L01

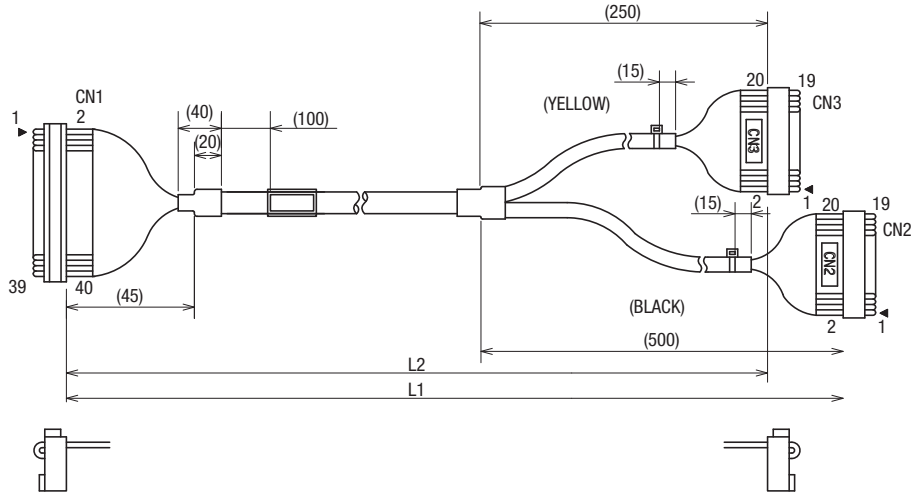

XW2Z-_FH-L02

PLC connection	Terminal connection	Wiring	Length in cm (L1)					Length in cm (L2)					Order code		
			75	100	200	300	400	500	50	75	175	275		375	475
40-pin MIL	Two 20-pin MIL	Straight	■	-	-	-	-	-	■	-	-	-	-	-	XW2Z-0075FH-L02
			-	■	-	-	-	-	-	■	-	-	-	-	XW2Z-0100FH-L02
			-	-	■	-	-	-	-	-	■	-	-	-	XW2Z-0200FH-L02
			-	-	-	■	-	-	-	-	-	■	-	-	XW2Z-0300FH-L02
			-	-	-	-	-	■	-	-	-	-	-	■	XW2Z-0500FH-L02

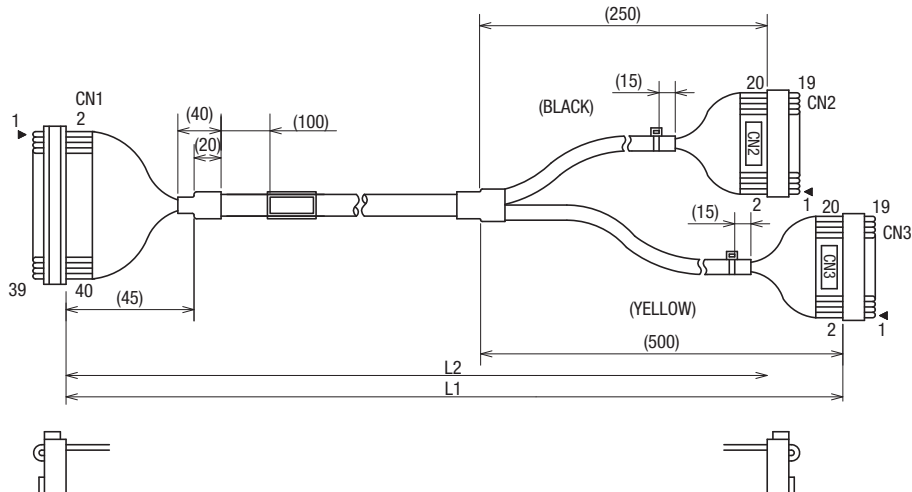

XW2Z-FF-L

PLC connection	Terminal connection	Wiring	Length in cm (L1)									Order code		
			30	50	75	100	150	200	250	300	400		500	
40-pin MIL	40-pin MIL	Straight	■	-	-	-	-	-	-	-	-	-	XW2Z-0030FF-L	
			-	■	-	-	-	-	-	-	-	-	XW2Z-0050FF-L	
			-	-	■	-	-	-	-	-	-	-	-	XW2Z-0100FF-L
			-	-	-	■	-	-	-	-	-	-	-	XW2Z-0150FF-L
			-	-	-	-	-	■	-	-	-	-	-	XW2Z-0200FF-L
			-	-	-	-	-	-	-	■	-	-	-	XW2Z-0300FF-L
-	-	-	-	-	-	-	-	-	-	■	-	XW2Z-0500FF-L		

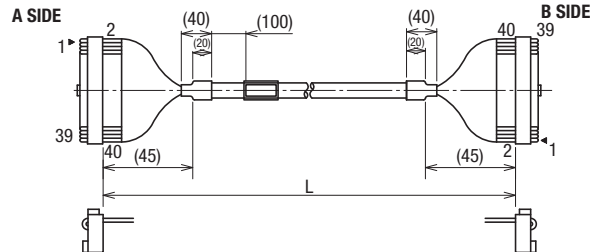

XW2Z-FN-L

PLC connection	Terminal connection	Wiring	Length in cm (L1)									Order code		
			30	50	75	100	150	200	250	300	400		500	
40-pin MIL	Loose Wires	Straight	-	-	-	■	-	-	-	-	-	-	XW2Z-0100FN-L	
			-	-	-	-	■	-	-	-	-	-	XW2Z-0150FN-L	
			-	-	-	-	-	■	-	-	-	-	-	XW2Z-0200FN-L
			-	-	-	-	-	-	■	-	-	-	-	XW2Z-0250FN-L
			-	-	-	-	-	-	-	■	-	-	-	XW2Z-0300FN-L
			-	-	-	-	-	-	-	-	-	■	-	XW2Z-0500FN-L

A SIDE

