

# MOSFET – Power, N-Channel, Silicon Carbide, TO-247-4L 1200 V, 80 mΩ

## NVH4L080N120SC1

### Description

Silicon Carbide (SiC) MOSFET uses a completely new technology that provide superior switching performance and higher reliability compared to Silicon. In addition, the low ON resistance and compact chip size ensure low capacitance and gate charge. Consequently, system benefits include highest efficiency, faster operation frequency, increased power density, reduced EMI, and reduced system size.

### Features

- 1200 V @  $T_J = 175^\circ\text{C}$
- Max  $R_{DS(on)} = 110\text{ m}\Omega$  at  $V_{GS} = 20\text{ V}$ ,  $I_D = 20\text{ A}$
- High Speed Switching with Low Capacitance
- 100% Avalanche Tested
- Qualified for Automotive According to AEC-Q101
- RoHS Compliant

### Applications

- Automotive Auxiliary Motor Drive
- Automotive On Board Charger
- Automotive DC/DC Converter for EV/HEV



ON Semiconductor®

[www.onsemi.com](http://www.onsemi.com)

$V_{DSS}$	$R_{DS(ON)}$ TYP	$I_D$ MAX
1200 V	80 mΩ	29 A

### N-CHANNEL MOSFET

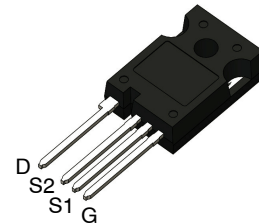
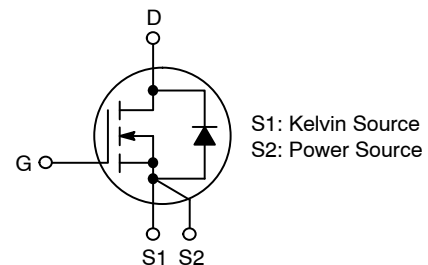

TO-247-4LD  
CASE 340CJ

### MARKING DIAGRAM

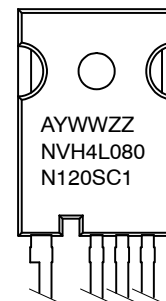

A = Assembly Location  
Y = Year  
WW = Work Week  
ZZ = Lot Traceability  
NVH4L080N120SC1 = Specific Device Code

### ORDERING INFORMATION

See detailed ordering and shipping information on page 2 of this data sheet.

# NVH4L080N120SC1

## ABSOLUTE MAXIMUM RATINGS (T<sub>A</sub> = 25°C, unless otherwise noted)

Symbol	Parameter		Ratings	Unit
V <sub>DSmax</sub>	Drain-to-Source Voltage		1200	V
V <sub>GSmax</sub>	Max. Gate-to-Source Voltage	@ T <sub>C</sub> < 150°C	-15 / +25	V
V <sub>GSop(DC)</sub>	Recommended operation Values of Gate - Source Voltage	@ T <sub>C</sub> < 150°C	-5 / +20	V
V <sub>GSop(AC)</sub>	Recommended operation Values of Gate - Source Voltage (f > 1 Hz)	@ T <sub>C</sub> < 150°C	-5 / +20	V
I <sub>D</sub>	Continuous Drain Current	V <sub>GS</sub> = 20 V, T <sub>C</sub> = 25°C	29	A
		V <sub>GS</sub> = 20 V, T <sub>C</sub> = 100°C	21	
I <sub>D(Pulse)</sub>	Pulse Drain Current	Pulse width tp limited by T <sub>j</sub> max	125	A
E <sub>AS</sub>	Single Pulse Avalanche Energy (Note 1)		171	mJ
P <sub>tot</sub>	Power Dissipation	T <sub>C</sub> = 25°C	170	W
		T <sub>C</sub> = 150°C	28	
T <sub>J</sub> , T <sub>STG</sub>	Operating and Storage Junction Temperature Range		-55 to +175	°C

Stresses exceeding those listed in the Maximum Ratings table may damage the device. If any of these limits are exceeded, device functionality should not be assumed, damage may occur and reliability may be affected.

1. E<sub>AS</sub> of 171 mJ is based on starting T<sub>J</sub> = 25°C, L = 1 mH, I<sub>AS</sub> = 18.5 A, V<sub>DD</sub> = 50 V, R<sub>G</sub> = 25 Ω.

## THERMAL CHARACTERISTICS

Symbol	Parameter	Ratings	Unit
R <sub>θJC</sub>	Thermal Resistance, Junction-to-Case	0.88	°C/W
R <sub>θJA</sub>	Thermal Resistance, Junction-to-Ambient	40	

## PACKAGE MARKING AND ORDERING INFORMATION

Part Number	Top Marking	Package	Packing Method	Reel Size	Tape Width	Quantity
NVH4L080N120SC1	NVH4L080N120SC1	TO-247-4L	Tube	N/A	N/A	30 Units

# NVH4L080N120SC1

## ELECTRICAL CHARACTERISTICS (T<sub>C</sub> = 25°C unless otherwise noted)

Symbol	Parameter	Test Conditions	Min	Typ	Max	Unit
--------	-----------	-----------------	-----	-----	-----	------

### OFF CHARACTERISTICS

BV <sub>DSS</sub>	Drain-to-Source Breakdown Voltage	I <sub>D</sub> = 100 μA, V <sub>GS</sub> = 0 V	1200	-	-	V
ΔBV <sub>DSS</sub> /ΔT <sub>J</sub>	Breakdown Voltage Temperature Coefficient	I <sub>D</sub> = 5 mA, Referenced to 25°C	-	0.3	-	V/°C
I <sub>DSS</sub>	Zero Gate Voltage Drain Current	V <sub>DS</sub> = 1200 V, V <sub>GS</sub> = 0 V T <sub>C</sub> = 25°C T <sub>C</sub> = 150°C	- -	- -	100 1.0	μA mA
I <sub>GSS</sub>	Gate-to-Source Leakage Current	V <sub>GS</sub> = 25 V, V <sub>DS</sub> = 0 V	-	-	1	μA
I <sub>GSSR</sub>	Gate-to-Source Leakage Current, Reverse	V <sub>GS</sub> = -15 V, V <sub>DS</sub> = 0 V	-	-	-1	μA

### ON CHARACTERISTICS

V <sub>GS(th)</sub>	Gate-to-Source Threshold Voltage	V <sub>GS</sub> = V <sub>DS</sub> , I <sub>D</sub> = 5 mA	1.8	2.75	4.3	V
R <sub>DS(on)</sub>	Static Drain-to-Source On Resistance	V <sub>GS</sub> = 20 V, I <sub>D</sub> = 20 A	-	80	110	mΩ
		V <sub>GS</sub> = 20 V, I <sub>D</sub> = 20 A, T <sub>C</sub> = 150°C	-	127	162	
g <sub>FS</sub>	Forward Transconductance	V <sub>DS</sub> = 20 V, I <sub>D</sub> = 20 A	-	11.3	-	S
		V <sub>DS</sub> = 20 V, I <sub>D</sub> = 20 A, T <sub>C</sub> = 150°C	-	9.8	-	

### DYNAMIC CHARACTERISTICS

C <sub>iss</sub>	Input Capacitance	V <sub>DS</sub> = 800 V, V <sub>GS</sub> = 0 V, f = 1 MHz	-	1112	1670	pF
C <sub>oss</sub>	Output Capacitance		-	80	120	pF
C <sub>rss</sub>	Reverse Transfer Capacitance		-	6.5	10	pF
E <sub>oss</sub>	C <sub>oss</sub> Stored Energy		-	32	-	μJ

### SWITCHING CHARACTERISTICS

t <sub>d(on)</sub>	Turn-On Delay Time	V <sub>CC</sub> = 800 V, I <sub>C</sub> = 20 A, V <sub>GS</sub> = -5/20 V, R <sub>G</sub> = 4.7 Ω Inductive Load, T <sub>C</sub> = 25°C	-	9	18	ns
t <sub>r</sub>	Rise Time		-	4.2	10	ns
t <sub>d(off)</sub>	Turn-Off Delay Time		-	26.8	43	ns
t <sub>f</sub>	Fall Time		-	5.4	11	ns
E <sub>on</sub>	Turn-on Switching Loss		-	314	-	μJ
E <sub>off</sub>	Turn-off Switching Loss		-	32	-	μJ
E <sub>ts</sub>	Total Switching Loss		-	346	-	μJ
Q <sub>g</sub>	Total Gate Charge	V <sub>DD</sub> = 600 V, I <sub>D</sub> = 20 A V <sub>GS</sub> = -5/20 V	-	56	-	nC
Q <sub>gs</sub>	Gate-to-Source Charge		-	11	-	nC
Q <sub>gd</sub>	Gate-to-Drain Charge		-	12	-	nC
R <sub>G</sub>	Gate input resistance	f = 1 MHz, D-S short	-	1.7	-	Ω

### DIODE CHARACTERISTICS

V <sub>SD</sub>	Source-to-Drain Diode Forward Voltage	V <sub>GS</sub> = -5 V, I <sub>SD</sub> = 10 A	T <sub>C</sub> = 25°C	-	3.7	-	V
			T <sub>C</sub> = 150°C	-	3.3	-	
E <sub>rec</sub>	Reverse Recovery Energy	I <sub>SD</sub> = 20 A, V <sub>GS</sub> = -5 V, V <sub>R</sub> = 600 V, di <sub>SD</sub> /dt = 1000 A/μs	T <sub>C</sub> = 150°C	-	29	-	μJ
t <sub>rr</sub>	Diode Reverse Recovery Time		T <sub>C</sub> = 25°C	-	18	-	ns
			T <sub>C</sub> = 150°C	-	31	-	
Q <sub>rr</sub>	Diode Reverse Recovery Charge		T <sub>C</sub> = 25°C	-	80	-	nC
			T <sub>C</sub> = 150°C	-	212	-	
I <sub>rrm</sub>	Peak Reverse Recovery Current	T <sub>C</sub> = 25°C	-	9	-	A	
		T <sub>C</sub> = 150°C	-	14	-		

Product parametric performance is indicated in the Electrical Characteristics for the listed test conditions, unless otherwise noted. Product performance may not be indicated by the Electrical Characteristics if operated under different conditions.

# NVH4L080N120SC1

TYPICAL CHARACTERISTICS  $T_J = 25^\circ\text{C}$  unless otherwise noted

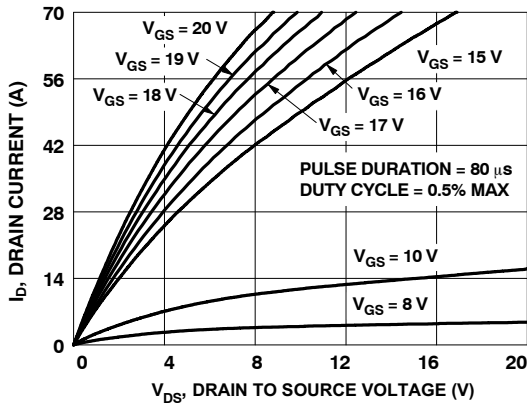

Figure 1. On Region Characteristics

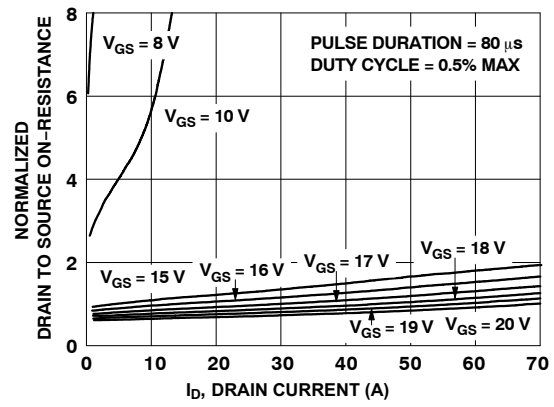

Figure 2. Normalized On-Resistance vs. Drain Current and Gate Voltage

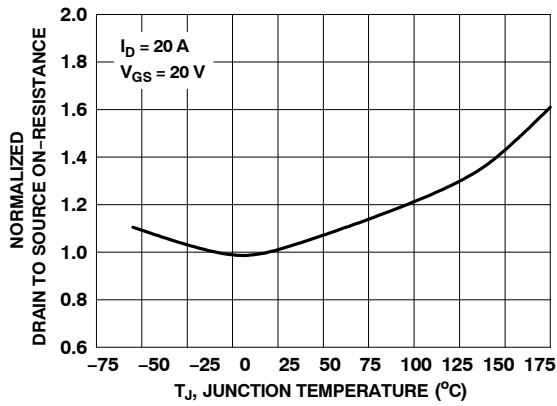

Figure 3. Normalized On Resistance vs. Junction Temperature

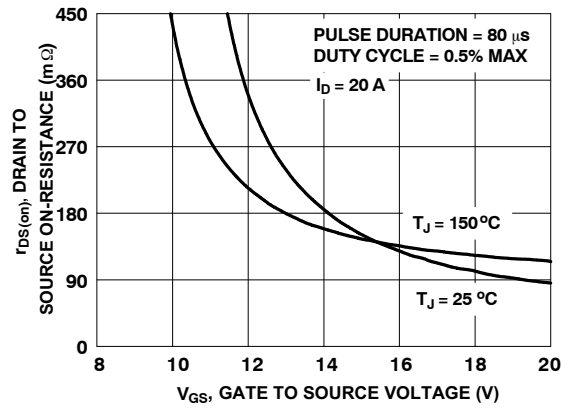

Figure 4. On-Resistance vs. Gate-to-Source Voltage

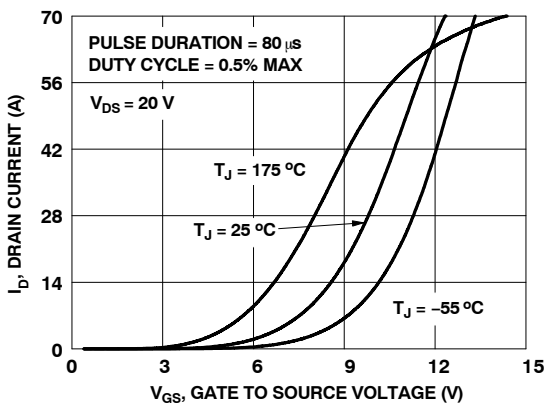

Figure 5. Transfer Characteristics

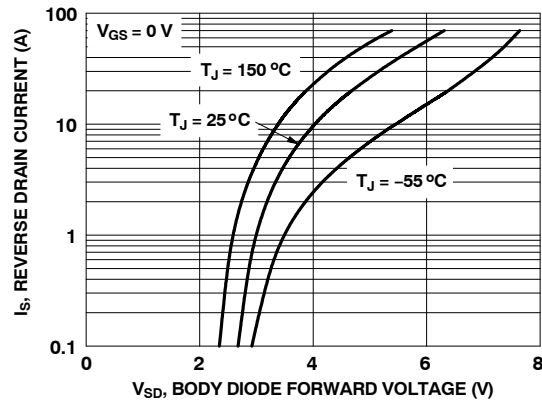

Figure 6. Source-to-Drain Diode Forward Voltage vs. Source Current

# NVH4L080N120SC1

## TYPICAL CHARACTERISTICS $T_J = 25^\circ\text{C}$ unless otherwise noted

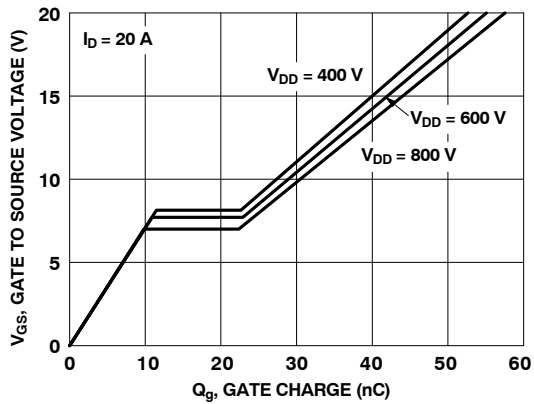

Figure 7. Gate Charge Characteristics

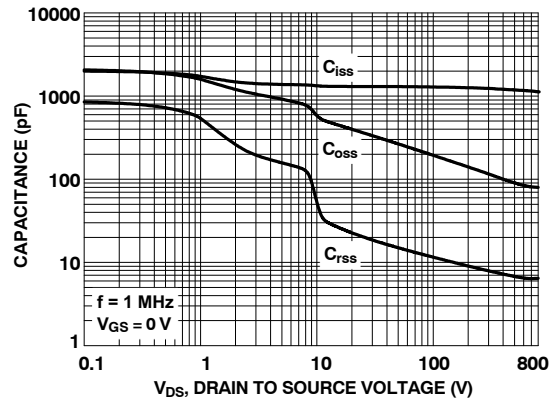

Figure 8. Capacitance vs. Drain-to-Source Voltage

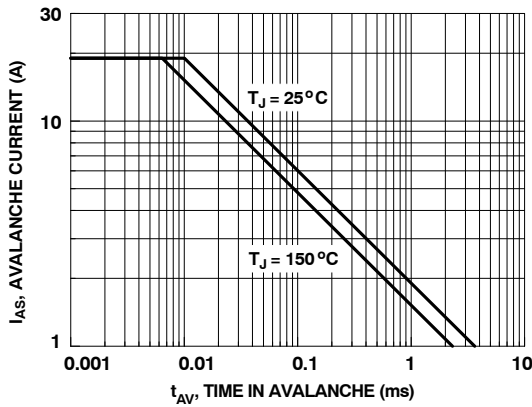

Figure 9. Unclamped Inductive Switching Capability

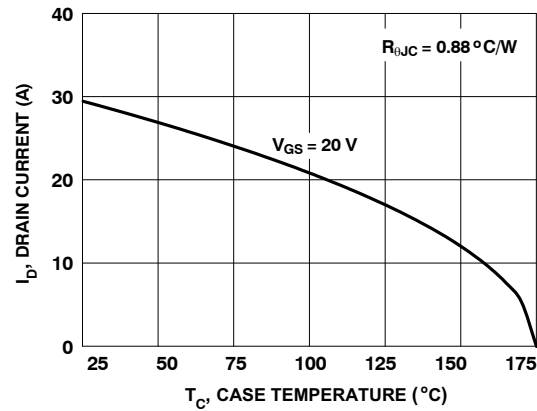

Figure 10. Maximum Continuous Drain Current vs. Case Temperature

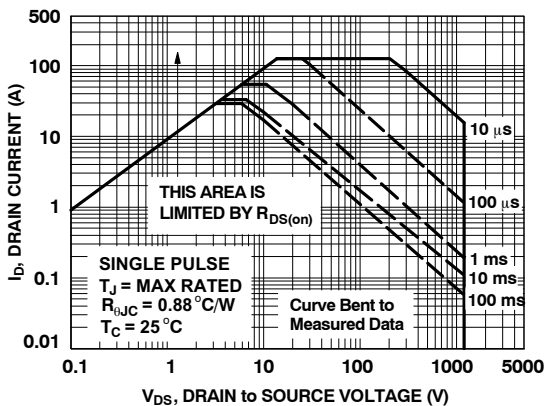

Figure 11. Forward Bias Safe Operating Area

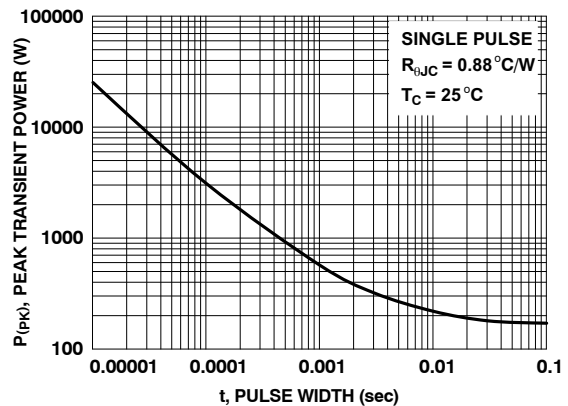

Figure 12. Single Pulse Maximum Power Dissipation

# NVH4L080N120SC1

TYPICAL CHARACTERISTICS  $T_J = 25^\circ\text{C}$  unless otherwise noted

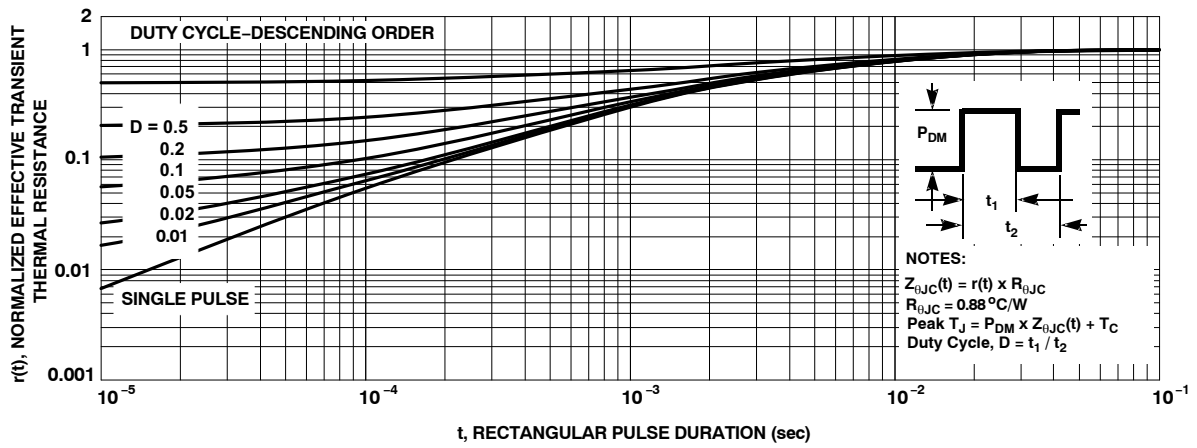
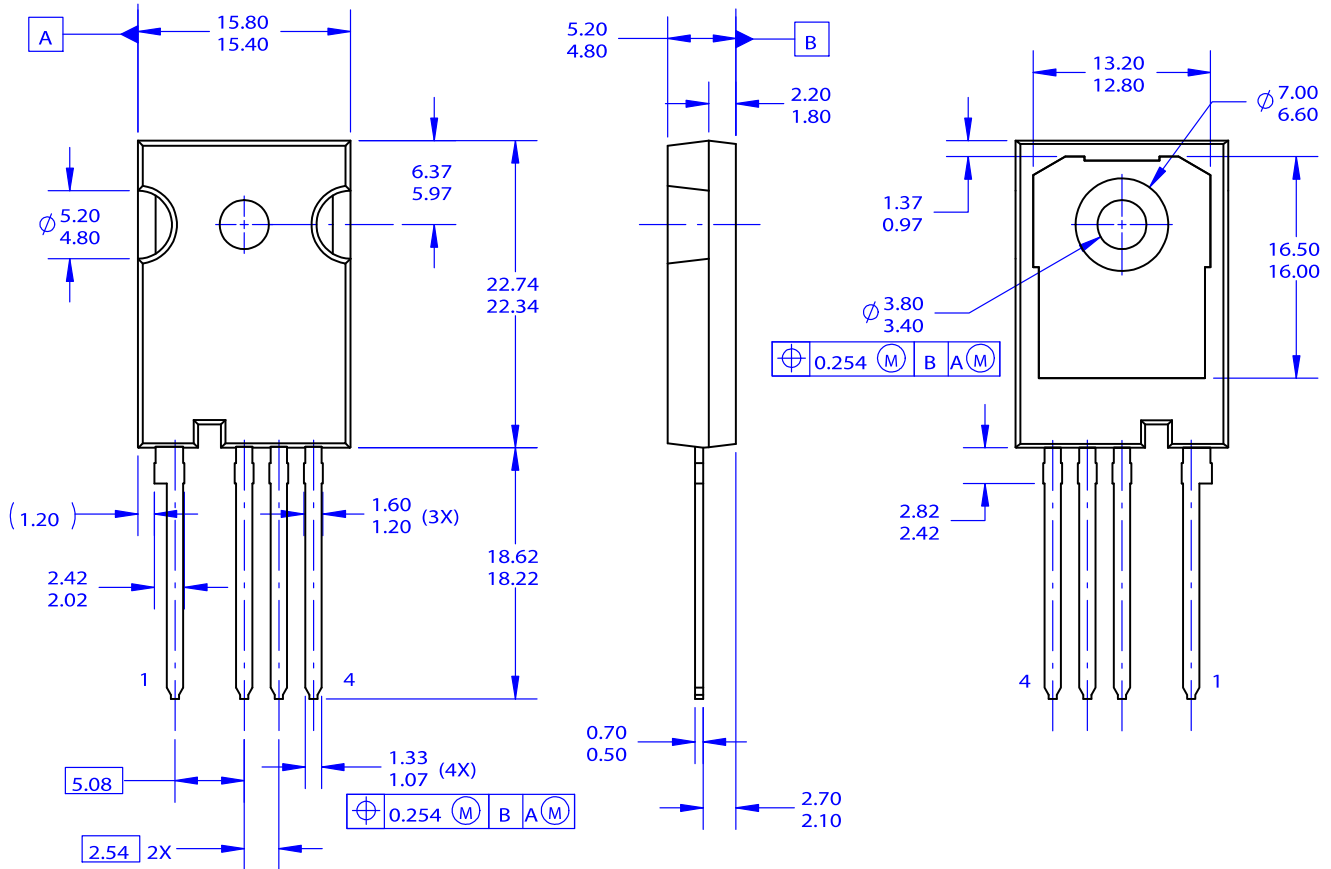

Figure 13. Junction-to-Case Transient Thermal Response Curve

# NVH4L080N120SC1

## PACKAGE DIMENSIONS

TO-247-4LD  
CASE 340CJ  
ISSUE O



### NOTES:

- A. NO INDUSTRY STANDARD APPLIES TO THIS PACKAGE.
- B. DIMENSIONS ARE EXCLUSIVE OF BURRS, MOLD FLASH, AND TIE BAR EXTRUSIONS.
- C. ALL DIMENSIONS ARE IN MILLIMETERS.
- D. DRAWING CONFORMS TO ASME Y14.5-2009.

ON Semiconductor and are trademarks of Semiconductor Components Industries, LLC dba ON Semiconductor or its subsidiaries in the United States and/or other countries. ON Semiconductor owns the rights to a number of patents, trademarks, copyrights, trade secrets, and other intellectual property. A listing of ON Semiconductor's product/patent coverage may be accessed at [www.onsemi.com/site/pdf/Patent-Marking.pdf](http://www.onsemi.com/site/pdf/Patent-Marking.pdf). ON Semiconductor reserves the right to make changes without further notice to any products herein. ON Semiconductor makes no warranty, representation or guarantee regarding the suitability of its products for any particular purpose, nor does ON Semiconductor assume any liability arising out of the application or use of any product or circuit, and specifically disclaims any and all liability, including without limitation special, consequential or incidental damages. Buyer is responsible for its products and applications using ON Semiconductor products, including compliance with all laws, regulations and safety requirements or standards, regardless of any support or applications information provided by ON Semiconductor. "Typical" parameters which may be provided in ON Semiconductor data sheets and/or specifications can and do vary in different applications and actual performance may vary over time. All operating parameters, including "Typicals" must be validated for each customer application by customer's technical experts. ON Semiconductor does not convey any license under its patent rights nor the rights of others. ON Semiconductor products are not designed, intended, or authorized for use as a critical component in life support systems or any FDA Class 3 medical devices or medical devices with a same or similar classification in a foreign jurisdiction or any devices intended for implantation in the human body. Should Buyer purchase or use ON Semiconductor products for any such unintended or unauthorized application, Buyer shall indemnify and hold ON Semiconductor and its officers, employees, subsidiaries, affiliates, and distributors harmless against all claims, costs, damages, and expenses, and reasonable attorney fees arising out of, directly or indirectly, any claim of personal injury or death associated with such unintended or unauthorized use, even if such claim alleges that ON Semiconductor was negligent regarding the design or manufacture of the part. ON Semiconductor is an Equal Opportunity/Affirmative Action Employer. This literature is subject to all applicable copyright laws and is not for resale in any manner.

### PUBLICATION ORDERING INFORMATION

LITERATURE FULFILLMENT:  
Email Requests to: [orderlit@onsemi.com](mailto:orderlit@onsemi.com)

TECHNICAL SUPPORT  
North American Technical Support:  
Voice Mail: 1 800-282-9855 Toll Free USA/Canada  
Phone: 011 421 33 790 2910

Europe, Middle East and Africa Technical Support:  
Phone: 00421 33 790 2910  
For additional information, please contact your local Sales Representative