

LQW18AN18NJ00#

"#" indicates a package specification code.

Size Code 1608 (0603) in mm (in inch), Wound Type



< List of part numbers with package codes >

LQW18AN18NJ00B LQW18AN18NJ00J LQW18AN18NJ00D

Appearance & Shape

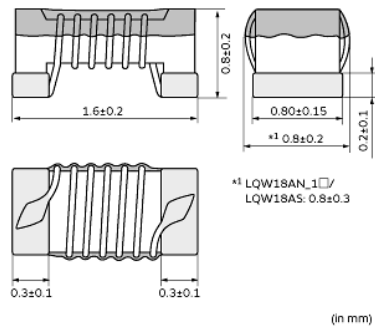

References

Packaging	Specifications	Minimum Order Quantity
B	Bulk(Bag)	500
J	330mm Paper Tape	10000
D	180mm Paper Tape	4000

Mass (typ.)	
1 piece	0.003g

Attention

1.This datasheet is downloaded from the website of Murata Manufacturing Co., Ltd. Therefore, it's specifications are subject to change or our products in it may be discontinued without advance notice. Please check with our sales representatives or product engineers before ordering.

2.This datasheet has only typical specifications because there is no space for detailed specifications.

Therefore, please review our product specifications or consult the approval sheet for product specifications before ordering.

LQW18AN18NJ00#

“#” indicates a package specification code.

Specifications

L size	1.6±0.2mm
W size	0.8±0.2mm
T size	0.8±0.2mm
Size code inch (mm)	0603 (1608)
Inductance	18nH±5%
Inductance Test Frequency	100MHz
Rated current (Itemp) (Based on Temperature rise)	550mA
Max. of DC resistance	0.16Ω
Q(min.)	40
Q Test Frequency	250MHz
Self resonance frequency (min.)	5500MHz
Operating Temperature Range(Self-temperature rise is not included)	-55°C to 125°C
Series	LQW18AN_00

Attention

1.This datasheet is downloaded from the website of Murata Manufacturing Co., Ltd. Therefore, it's specifications are subject to change or our products in it may be discontinued without advance notice. Please check with our sales representatives or product engineers before ordering.

2.This datasheet has only typical specifications because there is no space for detailed specifications.

Therefore, please review our product specifications or consult the approval sheet for product specifications before ordering.

LQW18AN18NJ00#

"#" indicates a package specification code.

Characteristic Data

The charts below may show another part number which shares its characteristics.

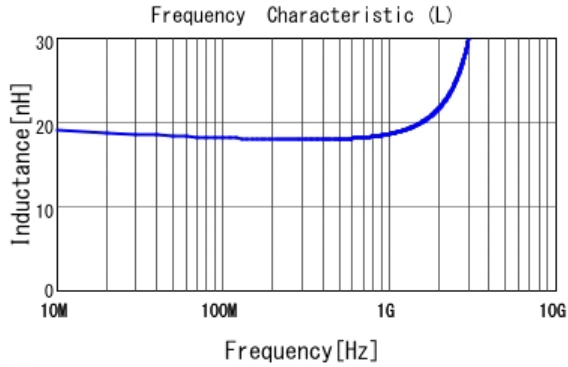

■ LQW18AN18NJ00 L

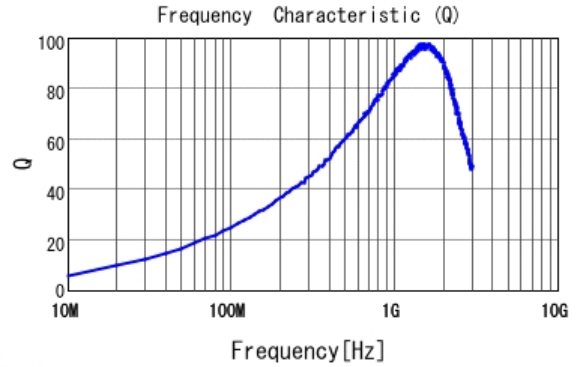

■ LQW18AN18NJ00 Q

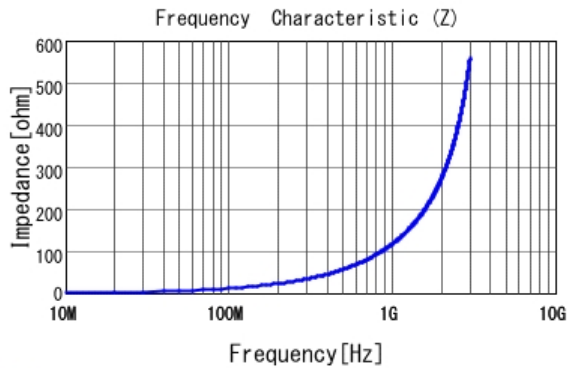

■ LQW18AN18NJ00 |Z|

Attention

- 1.This datasheet is downloaded from the website of Murata Manufacturing Co., Ltd. Therefore, it's specifications are subject to change or our products in it may be discontinued without advance notice. Please check with our sales representatives or product engineers before ordering.
- 2.This datasheet has only typical specifications because there is no space for detailed specifications.
Therefore, please review our product specifications or consult the approval sheet for product specifications before ordering.