

NFL18SP207X1A3#

"#" indicates a package specification code.



< List of part numbers with package codes >

NFL18SP207X1A3D NFL18SP207X1A3B

Appearance & Shape

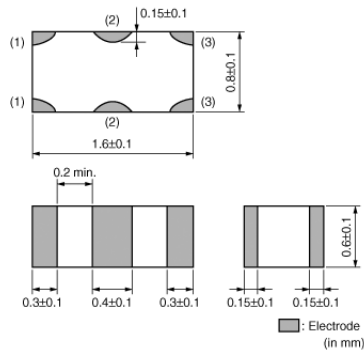

Packaging Information

Packaging	Specifications	Minimum Order Quantity
D	180mm Paper Tape	4000
B	Bulk(Bag)	1000

Applications

Other Usage	For general
-------------	-------------

Attention
1.This datasheet is downloaded from the website of Murata Manufacturing Co., Ltd. Therefore, it's specifications are subject to change or our products in it may be discontinued without advance notice. Please check with our sales representatives or product engineers before ordering.
2.This datasheet has only typical specifications because there is no space for detailed specifications.
Therefore, please review our product specifications or consult the approval sheet for product specifications before ordering.

NFL18SP207X1A3#

“#” indicates a package specification code.

Features

The chip "EMIFIL" NFL18SP series is an EMI Suppression filter for high speed signal lines, achieving pi-type structure in 0603 size with Murata's multilayer technology.

Features

1. Ultra-small size in 1.6x0.8x0.6 mm
2. Achieves high performance in noise suppression over wide frequency range
3. Steep insertion loss characteristics realize excellent noise suppression and prevent distortion of signal waveform.
4. Line up 4 items of cut-off frequency range from 150 to 500MHz

Applications

EMI suppression for digital signal line such as RGB and high speed clock lines

Attention

- 1.This datasheet is downloaded from the website of Murata Manufacturing Co., Ltd. Therefore, it's specifications are subject to change or our products in it may be discontinued without advance notice. Please check with our sales representatives or product engineers before ordering.
- 2.This datasheet has only typical specifications because there is no space for detailed specifications.
Therefore, please review our product specifications or consult the approval sheet for product specifications before ordering.

NFL18SP207X1A3#

“#” indicates a package specification code.



Specifications

Shape	SMD
Size Code (in mm)	1608
Size Code (in inch)	0603
Length	1.6mm
Length Tolerance	±0.1mm
Width	0.8mm
Width Tolerance	±0.1mm
Thickness	0.6mm
Thickness Tolerance	±0.1mm
Rated Current	100mA
Operating Temperature Range	-55°C to 125°C
Mass(typ.)	0.004g
Number of Circuit	1
Rated Voltage	10Vdc
Withstanding Voltage	30Vdc
Insulation Resistance(min.)	1000MΩ
Nominal Cut-off Frequency	200MHz
Capacitance	24pF
Capacitance Tolerance	±20%
Inductance	80nH
Inductance Tolerance	±20%

Attention

1.This datasheet is downloaded from the website of Murata Manufacturing Co., Ltd. Therefore, it's specifications are subject to change or our products in it may be discontinued without advance notice. Please check with our sales representatives or product engineers before ordering.

2.This datasheet has only typical specifications because there is no space for detailed specifications.

Therefore, please review our product specifications or consult the approval sheet for product specifications before ordering.

NFL18SP207X1A3#

“#” indicates a package specification code.

Product Data

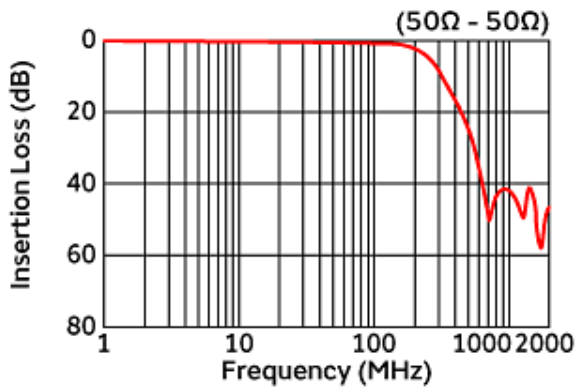

Insertion Loss Characteristics

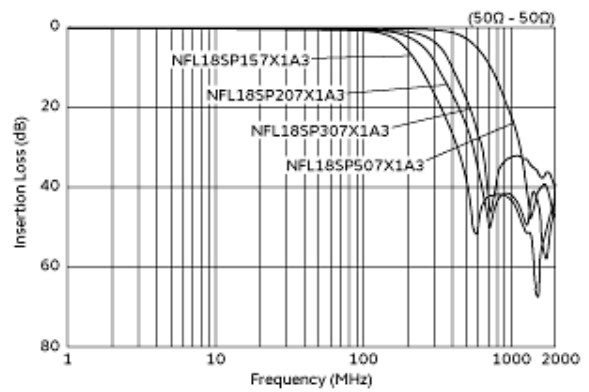

Insertion Loss Characteristics (Main Items)

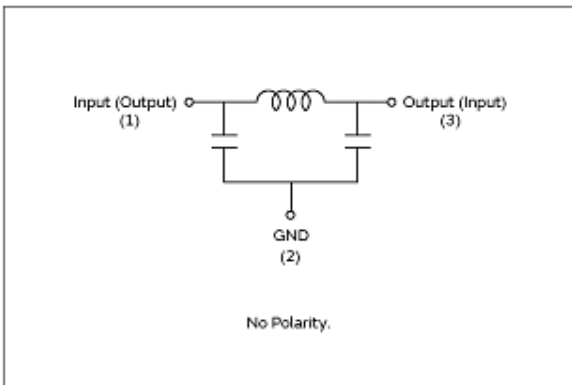

Equivalent Circuit

Attention

1.This datasheet is downloaded from the website of Murata Manufacturing Co., Ltd. Therefore, it's specifications are subject to change or our products in it may be discontinued without advance notice. Please check with our sales representatives or product engineers before ordering.
2.This datasheet has only typical specifications because there is no space for detailed specifications.
Therefore, please review our product specifications or consult the approval sheet for product specifications before ordering.