

Data sheet | Item number: 285-135

2-conductor through terminal block; 35 mm²; lateral marker slots; only for DIN 35 x 15 rail; POWER CAGE CLAMP; 35,00 mm²; gray

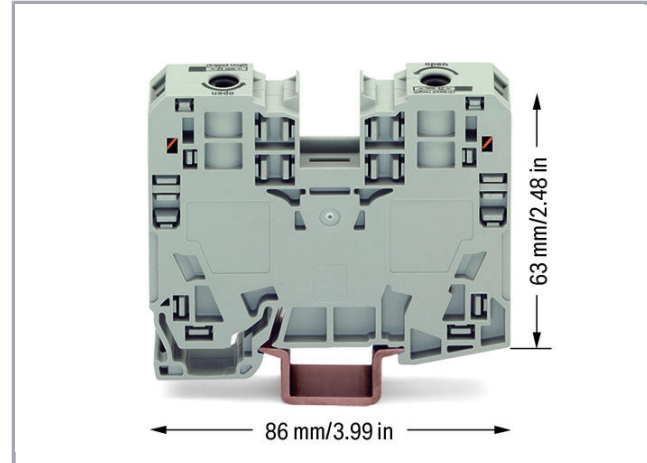

www.wago.com/285-135

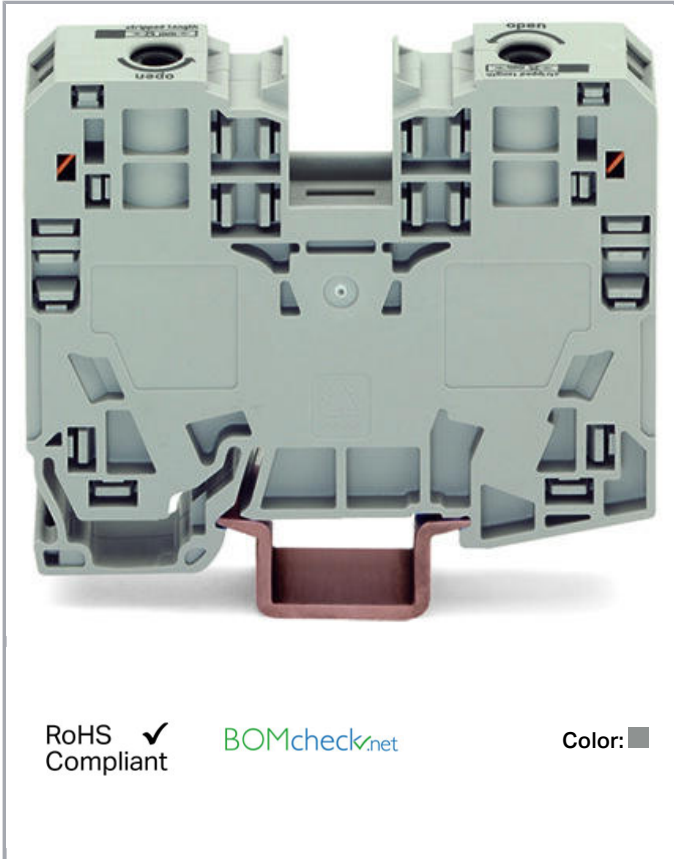

RoHS Compliant

[BOMcheck.net](https://www.bomcheck.net)

Color: ■

Data

Electrical data

Ratings per IEC/EN 60664-1

Ratings per	IEC/EN 60947-7-1
Nominal voltage (III/3)	1000 V
Rated surge voltage (III/3)	8 kV
Rated current	125 A
Legend (ratings)	(III / 3) ≙ Overvoltage category III / Pollution degree 3

Subject to changes. Please also observe the further product documentation!

WAGO Kontakttechnik GmbH & Co. KG
Hansastr. 27
32423 Minden
Phone: +49571 887-0 | Fax: +49571 887-169
Email: info.de@wago.com | Web: www.wago.com

Do you have any questions about our products?
We are always happy to take your call at +49 (571) 887-44222.



Connection data

Connection technology	POWER CAGE CLAMP
Actuation type	Operating tool
Connectable conductor materials	Copper
Solid conductor	6 ... 35 mm ² / 10 ... 2 AWG
Stranded conductor	6 ... 35 mm ² / 10 ... 2 AWG
Fine-stranded conductor	6 ... 35 mm ² / 10 ... 2 AWG
Strip length	25 mm / 0.98 inch
Total number of connection points	2
Total number of potentials	1
Number of levels	1
Wiring type	Side-entry wiring

Geometrical Data

Width	16 mm / 0.63 inch
Height from upper-edge of DIN-rail	63 mm / 2.48 inch
Depth	86 mm / 3.386 inch

Mechanical data

Design	horizontal type
Mounting type	DIN-35 rail
Marking level	Side marking

Material Data

Color	gray
Insulation material	Polyamide 66 (PA 66)
Fire load	1.246 MJ
Weight	79.3 g

Commercial data

Product Group	1 (Rail Mounted Terminal Blocks)
Packaging type	BOX
Country of origin	PL
GTIN	4045454507381
Customs tariff number	85369010000



Subject to changes. Please also observe the further product documentation!

WAGO Kontakttechnik GmbH & Co. KG
 Hansastr. 27
 32423 Minden
 Phone: +49571 887-0 | Fax: +49571 887-169
 Email: info.de@wago.com | Web: www.wago.com



Do you have any questions about our products?
 We are always happy to take your call at +49 (571) 887-44222.

Approvals / Certificates

Country specific Approvals

Logo	Approval	Additional Approval Text	Certificate name
	CCA DEKRA Certification B.V.	EN 60947	NTR NL-7707
	CSA DEKRA Certification B.V.	C22.2 No. 158	1151144
	KEMA/KEUR DEKRA Certification B.V.	EN 60947	71-101911

Ship Approvals

Logo	Approval	Additional Approval Text	Certificate name
	ABS American Bureau of Shipping	EN 60947	20-HG1941090-PDA
	DNV GL Det Norske Veritas, Germanischer Lloyd	-	TAE00001V2
	LR Lloyds Register	EN 60947	91/20112 (E9)

Counterpart



Compatible products

Subject to changes. Please also observe the further product documentation!



WAGO Kontakttechnik GmbH & Co. KG
Hansastr. 27
32423 Minden
Phone: +49571 887-0 | Fax: +49571 887-169
Email: info.de@wago.com | Web: www.wago.com

Do you have any questions about our products?
We are always happy to take your call at +49 (571) 887-44222.















assembling

	Item no.: 210-148 Angled support bracket; without screw	www.wago.com/210-148
	Item no.: 249-117 Screwless end stop; 10 mm wide; for DIN-rail 35 x 15 and 35 x 7.5; gray	www.wago.com/249-117
	Item no.: 249-197 Screwless end stop; 14 mm wide; for DIN-rail 35 x 15 and 35 x 7.5; gray	www.wago.com/249-197

Marking accessories

	Item no.: 2009-110 Marking strips; on reel; not stretchable; plain; snap-on type; white	www.wago.com/2009-110
	Item no.: 2009-115 WMB-Inline; for Smart Printer; 1500 pieces on roll; stretchable 5 - 5.2 mm; plain; snap-on type; white	www.wago.com/2009-115
	Item no.: 2009-115/000-002 WMB-Inline; for Smart Printer; 1500 pieces on roll; stretchable 5 - 5.2 mm; plain; snap-on type; yellow	www.wago.com/2009-115/000-002
	Item no.: 2009-115/000-005 WMB-Inline; for Smart Printer; 1500 pieces on roll; stretchable 5 - 5.2 mm; plain; snap-on type; red	www.wago.com/2009-115/000-005
	Item no.: 2009-115/000-006 WMB-Inline; for Smart Printer; 1500 pieces on roll; stretchable 5 - 5.2 mm; plain; snap-on type; blue	www.wago.com/2009-115/000-006
	Item no.: 2009-115/000-007 WMB-Inline; for Smart Printer; 1500 pieces on roll; stretchable 5 - 5.2 mm; plain; snap-on type; gray	www.wago.com/2009-115/000-007
	Item no.: 2009-115/000-012 WMB-Inline; for Smart Printer; 1500 pieces on roll; stretchable 5 - 5.2 mm; plain; snap-on type; orange	www.wago.com/2009-115/000-012
	Item no.: 2009-115/000-017 WMB-Inline; for Smart Printer; 1500 pieces on roll; stretchable 5 - 5.2 mm; plain; snap-on type; light green	www.wago.com/2009-115/000-017
	Item no.: 2009-115/000-023 WMB-Inline; for Smart Printer; 1500 pieces on roll; stretchable 5 - 5.2 mm; plain; snap-on type; green	www.wago.com/2009-115/000-023
	Item no.: 2009-115/000-024 WMB-Inline; for Smart Printer; 1500 pieces on roll; stretchable 5 - 5.2 mm; plain; snap-on type; violet	www.wago.com/2009-115/000-024

Subject to changes. Please also observe the further product documentation!

	Item no.: 249-105 Group marker carrier; gray	www.wago.com/249-105
	Item no.: 285-442 Adaptor; gray	www.wago.com/285-442
	Item no.: 793-501 WMB marking card; as card; not stretchable; plain; snap-on type; white	www.wago.com/793-501
	Item no.: 793-501/000-002 WMB marking card; as card; not stretchable; plain; snap-on type; yellow	www.wago.com/793-501/000-002
	Item no.: 793-501/000-005 WMB marking card; as card; not stretchable; plain; snap-on type; red	www.wago.com/793-501/000-005
	Item no.: 793-501/000-006 WMB marking card; as card; not stretchable; plain; snap-on type; blue	www.wago.com/793-501/000-006
	Item no.: 793-501/000-007 WMB marking card; as card; not stretchable; plain; snap-on type; gray	www.wago.com/793-501/000-007
	Item no.: 793-501/000-012 WMB marking card; as card; not stretchable; plain; snap-on type; orange	www.wago.com/793-501/000-012
	Item no.: 793-501/000-017 WMB marking card; as card; not stretchable; plain; snap-on type; light green	www.wago.com/793-501/000-017
	Item no.: 793-501/000-023 WMB marking card; as card; not stretchable; plain; snap-on type; green	www.wago.com/793-501/000-023
	Item no.: 793-501/000-024 WMB marking card; as card; not stretchable; plain; snap-on type; violet	www.wago.com/793-501/000-024
	Item no.: 793-5501 WMB marking card; as card; for terminal block width 5 - 17.5 mm; stretchable 5 - 5.2 mm; plain; snap-on type; white	www.wago.com/793-5501
	Item no.: 793-5501/000-002 WMB marking card; as card; for terminal block width 5 - 17.5 mm; stretchable 5 - 5.2 mm; plain; snap-on type; yellow	www.wago.com/793-5501/000-002
	Item no.: 793-5501/000-005 WMB marking card; as card; for terminal block width 5 - 17.5 mm; stretchable 5 - 5.2 mm; plain; snap-on type; red	www.wago.com/793-5501/000-005

Subject to changes. Please also observe the further product documentation!



Item no.: 793-5501/000-006

WMB marking card; as card; for terminal block width 5 - 17.5 mm; stretchable 5 - 5.2 mm; plain; snap-on type; blue

www.wago.com/793-5501/000-006



Item no.: 793-5501/000-007

WMB marking card; as card; for terminal block width 5 - 17.5 mm; stretchable 5 - 5.2 mm; plain; snap-on type; gray

www.wago.com/793-5501/000-007



Item no.: 793-5501/000-012

WMB marking card; as card; for terminal block width 5 - 17.5 mm; stretchable 5 - 5.2 mm; plain; snap-on type; orange

www.wago.com/793-5501/000-012



Item no.: 793-5501/000-014

WMB marking card; as card; for terminal block width 5 - 17.5 mm; stretchable 5 - 5.2 mm; plain; snap-on type; brown

www.wago.com/793-5501/000-014



Item no.: 793-5501/000-017

WMB marking card; as card; for terminal block width 5 - 17.5 mm; stretchable 5 - 5.2 mm; plain; snap-on type; green

www.wago.com/793-5501/000-017



Item no.: 793-5501/000-023

WMB marking card; as card; for terminal block width 5 - 17.5 mm; stretchable 5 - 5.2 mm; plain; snap-on type; light green

www.wago.com/793-5501/000-023



Item no.: 793-5501/000-024

WMB marking card; as card; for terminal block width 5 - 17.5 mm; stretchable 5 - 5.2 mm; plain; snap-on type; violet

www.wago.com/793-5501/000-024

protection



Item no.: 285-421

Finger guard; touchproof cover protects unused conductor entries; for 35 mm² high-current tbs; yellow

www.wago.com/285-421

tools



Item no.: 210-721

Operating tool; Blade: 5.5 x 0.8 mm; with a partially insulated shaft

www.wago.com/210-721

ferrule



Item no.: 216-413

Ferrule; Sleeve for 25 mm² / AWG 4; uninsulated; electro-tin plated; electrolytic copper; gastight crimped; acc. to DIN 46228, Part 1/08.92

www.wago.com/216-413



Item no.: 216-414

Ferrule; Sleeve for 35 mm² / AWG 2; uninsulated; electro-tin plated; electrolytic copper; gastight crimped; acc. to DIN 46228, Part 1/08.92

www.wago.com/216-414

Jumper



Item no.: 285-430

Step-down jumper; insulated; from 285-13x to 2010 and 2016 Series TOPJOB®S terminal blocks; Nominal current 90 A; gray

www.wago.com/285-430



Item no.: 285-435

Adjacent jumper; insulated; Nominal current 85 A; gray

www.wago.com/285-435

check

Subject to changes. Please also observe the further product documentation!



Item no.: 283-404
Test plug adapter; 11.6 mm wide; for 4 mm Ø test plugs; gray

www.wago.com/283-404

Carrier rail



Item no.: 210-114
Steel carrier rail; 35 x 15 mm; 1.5 mm thick; 2 m long; unslotted; similar to EN 60715

www.wago.com/210-114



Item no.: 210-118
Steel carrier rail; 35 x 15 mm; 2.3 mm thick; 2 m long; unslotted; according to EN 60715

www.wago.com/210-118



Item no.: 210-197
Steel carrier rail; 35 x 15 mm; 1.5 mm thick; 2 m long; slotted; similar to EN 60715

www.wago.com/210-197



Item no.: 210-198
Copper carrier rail; 35 x 15 mm; 2.3 mm thick; 2 m long; unslotted; according to EN 60715; copper-colored

www.wago.com/210-198



Item no.: 210-506
Steel carrier rail; 35 x 15 mm; 1.5 mm thick; 2 m long; unslotted; galvanized; similar to EN 60715

www.wago.com/210-506



Item no.: 210-508
Steel carrier rail; 35 x 15 mm; 1.5 mm thick; 2 m long; slotted; galvanized; similar to EN 60715

www.wago.com/210-508

potential distribution



Item no.: 283-407
Power tap; with 500 mm cable; for 16 mm² (283/783 Series) and 35 mm²; gray

www.wago.com/283-407



Item no.: 285-427
Power tap; for 35 mm² high-current tbs; Module width 8 mm; 6,00 mm²; gray

www.wago.com/285-427

Protective Warning Marker



Item no.: 285-420
Protective warning marker; with high-voltage symbol, black; yellow

www.wago.com/285-420

Downloads

Documentation

Bid Text

285-135 doc - Datei	Jan 4, 2018	doc 24.1 kB	Download
------------------------	-------------	----------------	----------

285-135 GAEB X81 - Datei	Feb 19, 2019	xml 3.3 kB	Download
-----------------------------	--------------	---------------	----------

Additional Information

Technical explanations	Apr 3, 2019	pdf 2.1 MB	Download
------------------------	-------------	---------------	----------

Subject to changes. Please also observe the further product documentation!

CAD/CAE-Data

CAD data

2D/3D Models 285-135	URL	Download
----------------------	-----	----------

CAE data

EPLAN Data Portal 285-135	URL	Download
---------------------------	-----	----------

WSCAD Universe 285-135	URL	Download
------------------------	-----	----------

Handling Instructions

Installation

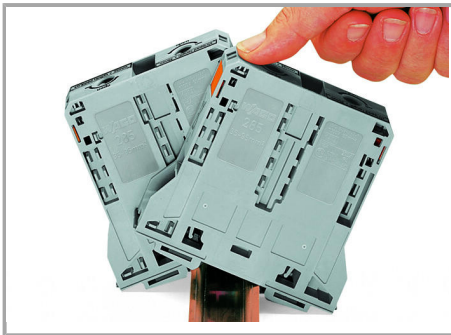

Snapping a terminal block onto the DIN-rail.

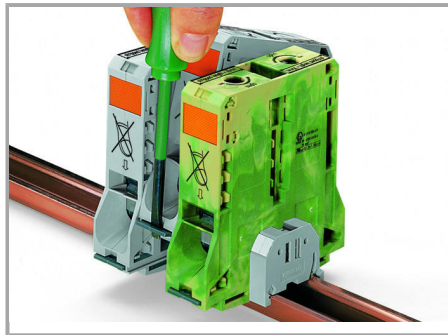

Removing a terminal block from the assembly.

Conductor termination

Subject to changes. Please also observe the further product documentation!

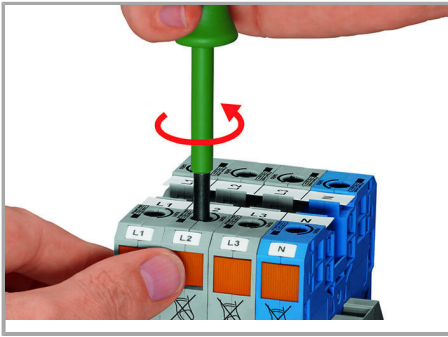

Conductor termination – step 1

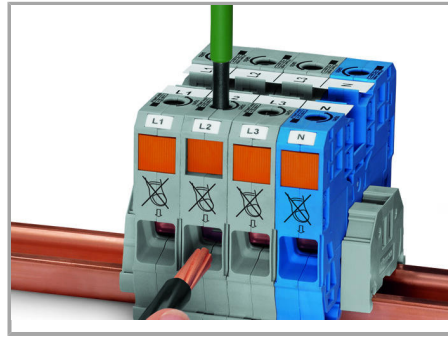

Conductor termination – step 2

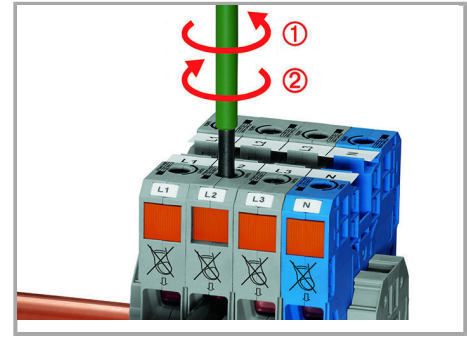

Conductor termination – step 3

Rotate the operating tool (5.5 mm blade width) counter-clockwise. Next, push in the orange locking tab. The clamp is locked open for hands-free wiring.

Insert a stripped conductor into the clamping unit until it hits backstop. Hold in this position.

A small counter-clockwise rotation closes the clamp, securing conductor. When unlocked, allow operating tool to rotate clockwise to securely terminate the conductor.

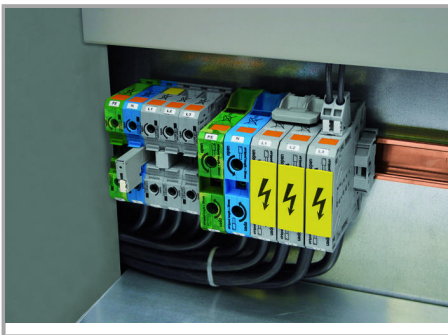

Side-entry wiring means that even larger conductors, which have limited flexibility, can be easily connected.

Commoning

Subject to changes. Please also observe the further product documentation!

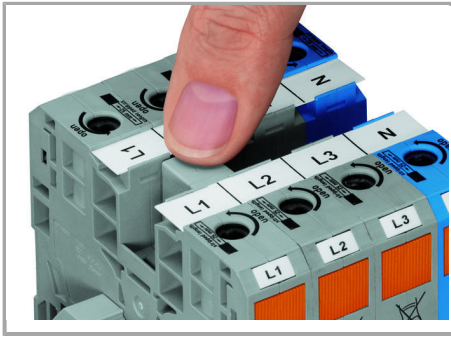

Commoning adjacent terminal blocks using a centrally positioned push-in jumper.



Slide the marking strip laterally to remove the jumper.

Commoning

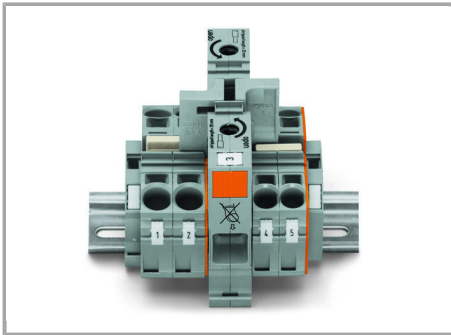

Commoning 35 mm² (2 AWG) POWER CAGE CLAMP Terminal Blocks with 10/16 mm² (8/6 AWG) 2010 and 2016 Series TOPJOP® S Terminal Blocks using step-down jumpers (not valid for 2016-76xx and 2016-77xx).

Subject to changes. Please also observe the further product documentation!

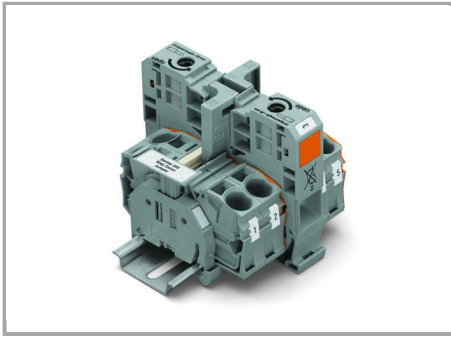

Step-down jumpers may common terminal blocks of different sizes, without losing a conductor clamping point. This can be beneficial on long conductor runs where voltage drops may be problematic. A large conductor can be easily connected to smaller conductors at the distribution point.

Step-down jumpers are simply pushed down for full insertion, similar to adjacent jumpers. Commoning may be made in either direction using the special thin end plate to cover the open side. Additional through terminal blocks having a smaller cross-section may be commoned using adjacent jumpers.

In this case, pay attention that:

The total current of the outgoing circuits does not exceed the nominal current of the step-down jumper.

Voltage Tap

Subject to changes. Please also observe the further product documentation!

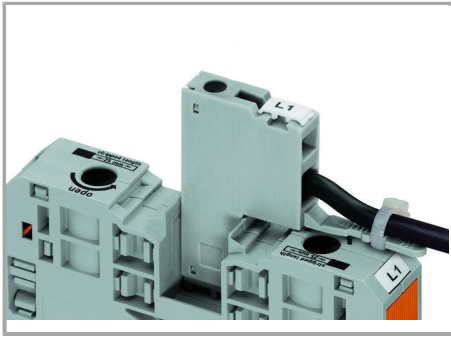

The power tap is inserted into the jumper contact slot. It can be fitted with a strain relief plate.

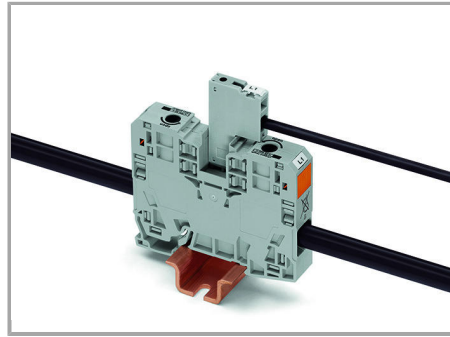

The power tap is inserted into the jumper contact slot.

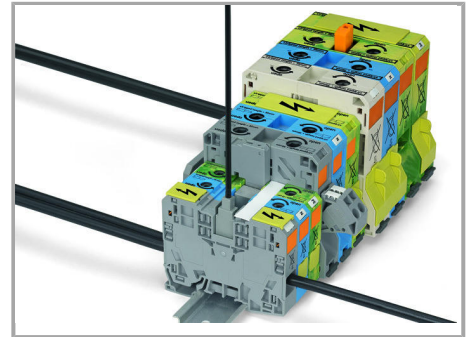

Always push power tap (283-407) down into the terminal block until fully inserted!

Testing

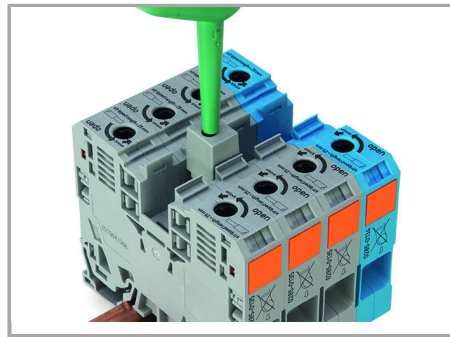
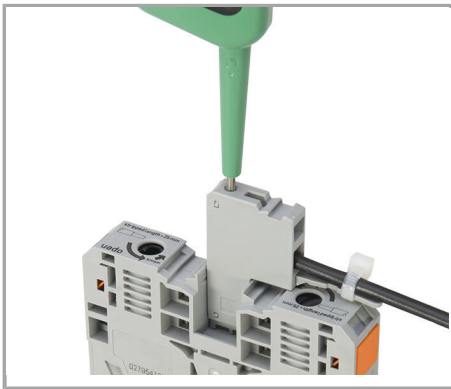

Testing with test plug adapter (283-404)

Testing

Marking

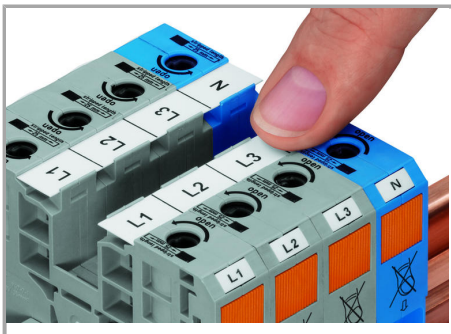

WMB markers or self-adhesive, printable marking strips can be accommodated on 35, 50 and 95 mm² high-current terminal blocks.

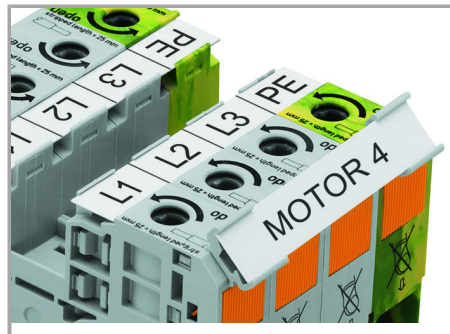

Marker carrier for marking strips (2009-110) or 2 x WMB markers for 285-13x, 285-15x and 285-19x terminal blocks

Subject to changes. Please also observe the further product documentation!

Data sheet | Item number: 285-135

www.wago.com/285-135



Product family

POWER CAGE CLAMP

[Show all products from the family](#)

Subject to changes. Please also observe the further product documentation!

WAGO Kontakttechnik GmbH & Co. KG
Hansastr. 27
32423 Minden
Phone: +49571 887-0 | Fax: +49571 887-169
Email: info.de@wago.com | Web: www.wago.com

Do you have any questions about our products?
We are always happy to take your call at +49 (571) 887-44222.