



PROGRAMMABLE CONTROLLERS

MELSEC iQ-F
series



MELSEC iQ-F



FX5 User's Manual (MODBUS Communication)

SAFETY PRECAUTIONS

(Read these precautions before use.)

Before using this product, please read this manual and the relevant manuals introduced in this manual carefully and pay attention to safety in order to handle the product correctly.

This manual classifies the safety precautions into two categories: [ WARNING] and [ CAUTION].

 WARNING	Indicates that incorrect handling may cause hazardous conditions, resulting in death or severe injury.
 CAUTION	Indicates that incorrect handling may cause hazardous conditions, resulting in minor or moderate injury or property damage.

Depending on the circumstances, procedures indicated by [ CAUTION] may also cause severe injury.

It is important to follow all precautions for personal safety.

Store this manual in a safe place so that it can be read whenever necessary. Always forward it to the end user.

[DESIGN PRECAUTIONS]

WARNING

- Make sure to set up the following safety circuits outside the PLC to ensure safe system operation even during external power supply problems or PLC failure. Otherwise, malfunctions may cause serious accidents.
 - (1) Note that when the CPU module detects an error, such as a watchdog timer error, during self-diagnosis, all outputs are turned off. Also, when an error that cannot be detected by the CPU module occurs in an input/output control block, output control may be disabled. External circuits and mechanisms should be designed to ensure safe machine operation in such a case.
 - Construct an interlock circuit in the program so that the whole system always operates on the safe side before executing the control (for data change) to the PLC in operation.

Read the manual thoroughly and ensure complete safety before executing other controls (for program change, parameter change, forcible output and operation status change) of the PLC in operation. Otherwise, the machine may be damaged and accidents may occur due to erroneous operations.
-

[WIRING PRECAUTIONS]

WARNING

- Make sure to cut off all phases of the power supply externally before attempting installation or wiring work. Failure to do so may cause electric shock or damage to the product.
 - Make sure to attach the terminal cover, provided as an accessory, before turning on the power or initiating operation after installation or wiring work. Failure to do so may cause electric shock.
 - The temperature rating of the cable should be 80°C or more.
 - Make sure to properly wire to the terminal block (European type) in accordance with the following precautions. Failure to do so may cause electric shock, equipment failures, a short-circuit, wire breakage, malfunctions, or damage to the product.
 - The disposal size of the cable end should follow the dimensions described in the manual.
 - Tightening torque should follow the specifications in the manual.
 - Twist the ends of stranded wires and make sure that there are no loose wires.
 - Do not solder-plate the electric wire ends.
 - Do not connect more than the specified number of wires or electric wires of unspecified size.
 - Affix the electric wires so that neither the terminal block nor the connected parts are directly stressed.
-

[WIRING PRECAUTIONS]

CAUTION

- Install module so that excessive force will not be applied to terminal blocks, power connectors, I/O connectors, communication connectors, or communication cables. Failure to do so may result in wire damage/breakage or PLC failure.
 - Make sure to observe the following precautions in order to prevent any damage to the machinery or accidents due to malfunction of the PLC caused by abnormal data written to the PLC due to the effects of noise.
 - (1) Do not bundle the power line, control line and communication cables together with or lay them close to the main circuit, high-voltage line, load line or power line. As a guideline, lay the power line, control line and communication cables at least 100 mm (3.94") away from the main circuit, high-voltage line, load line or power line.
 - (2) Ground the shield of the shielded wire or shielded cable at one point on the PLC. However, do not use common grounding with heavy electrical systems.
-

[STARTUP AND MAINTENANCE PRECAUTIONS]

WARNING

- Do not touch any terminal while the PLC's power is on. Doing so may cause electric shock or malfunctions.
 - Before cleaning or retightening terminals, cut off all phases of the power supply externally. Failure to do so in the power ON status may cause electric shock.
 - Before modifying the program in operation, forcible output, running or stopping the PLC, read through this manual carefully, and ensure complete safety. An operation error may damage the machinery or cause accidents.
 - Do not change the program in the PLC from two or more peripheral equipment devices at the same time. (i.e. from an engineering tool and a GOT) Doing so may cause destruction or malfunction of the PLC program.
-

[STARTUP AND MAINTENANCE PRECAUTIONS]

CAUTION

- Do not disassemble or modify the PLC. Doing so may cause fire, equipment failures, or malfunctions. For repair, contact your local Mitsubishi Electric representative.
 - Turn off the power to the PLC before connecting or disconnecting any extension cable. Failure to do so may cause equipment failures or malfunctions.
 - Turn off the power to the PLC before attaching or detaching the following devices. Failure to do so may cause equipment failures or malfunctions.
 - Peripheral devices, expansion board and expansion adapter
 - Extension modules, bus conversion module and connector conversion module
 - Battery
-

INTRODUCTION

This manual contains text, diagrams and explanations which will guide the reader in the correct installation, safe use and operation of the FX5 MODBUS Serial Communication and should be read and understood before attempting to install or use the unit.

It should be read and understood before attempting to install or use the unit. Store this manual in a safe place so that you can read it whenever necessary.

Always forward it to the end user.

Regarding use of this product

- This product has been manufactured as a general-purpose part for general industries, and has not been designed or manufactured to be incorporated in a device or system used in purposes related to human life.
- Before using the product for special purposes such as nuclear power, electric power, aerospace, medicine or passenger movement vehicles, consult Mitsubishi Electric.
- This product has been manufactured under strict quality control. However when installing the product where major accidents or losses could occur if the product fails, install appropriate backup or failsafe functions in the system.

Note

- If in doubt at any stage during the installation of the product, always consult a professional electrical engineer who is qualified and trained in the local and national standards. If in doubt about the operation or use, please consult the nearest Mitsubishi Electric representative.
- Since the examples indicated by this manual, technical bulletin, catalog, etc. are used as a reference, please use it after confirming the function and safety of the equipment and system. Mitsubishi Electric will accept no responsibility for actual use of the product based on these illustrative examples.
- This manual content, specification etc. may be changed, without a notice, for improvement.
- The information in this manual has been carefully checked and is believed to be accurate; however, if you notice a doubtful point, an error, etc., please contact the nearest Mitsubishi Electric representative. When doing so, please provide the manual number given at the end of this manual.

MEMO

CONTENTS

SAFETY PRECAUTIONS	1
INTRODUCTION	4
RELEVANT MANUALS	8
TERMS	8
CHAPTER 1 OUTLINE	10
1.1 Outline of Function	10
1.2 Procedure for Operation	11
CHAPTER 2 CONFIGURATION	12
2.1 System Configuration	12
CHAPTER 3 SPECIFICATIONS	14
3.1 Communication Specifications	14
3.2 Link Time	15
CHAPTER 4 MODBUS COMMUNICATION SPECIFICATIONS	18
4.1 MODBUS Protocol	18
Frame mode	19
List of supported MODBUS standard functions	19
CHAPTER 5 WIRING	20
5.1 Wiring Procedure	20
5.2 Selecting Connection	20
For RS-232C	20
For RS-485	20
Connecting cables	21
Termination resistor setting	22
5.3 Connection Diagram	23
Connection diagram for RS-232C	23
Connection diagram for RS-485	23
5.4 Grounding	24
CHAPTER 6 COMMUNICATION SETTING	25
6.1 Setup Method for MODBUS Serial Communication	25
Using the CPU module	25
Using an Extended board	26
Using an Expansion adapter	27
Contents of parameter setting	27
CHAPTER 7 FUNCTION	30
7.1 Master Function	30
7.2 Slave Function	33
7.3 Related Devices	33
List of related devices	33
Details of Related Devices	35

CHAPTER 8 CREATING PROGRAMS	41
8.1 Creating Programs for the Master Station	41
8.2 Cautions on Program Creation	41
APPENDIX	42
Appendix 1 Troubleshooting	42
Appendix 2 Error code	43
Appendix 3 The frame specifications of RTU mode	45
Procedure for generating of CRC	45
MODBUS protocol data unit formats	47
Appendix 4 Initial values of MODBUS device allocation	55
INDEX	57
REVISIONS	58
WARRANTY	59
TRADEMARKS	60

RELEVANT MANUALS

User's manuals for the applicable modules

Manual name <manual number>	Description
MELSEC iQ-F FX5 User's Manual (Startup) <JY997D58201>	Performance specifications, procedures before operation, and troubleshooting of the CPU module.
MELSEC iQ-F FX5U User's Manual (Hardware) <JY997D55301>	Describes the details of hardware of the FX5U CPU module, including input/output specifications, wiring, installation, and maintenance.
MELSEC iQ-F FX5UC User's Manual (Hardware) <JY997D61401>	Describes the details of hardware of the FX5UC CPU module, including input/output specifications, wiring, installation, and maintenance.
MELSEC iQ-F FX5 User's Manual (Application) <JY997D55401>	Describes basic knowledge required for program design, functions of the CPU module, devices/labels, and parameters.
MELSEC iQ-F FX5 Programming Manual (Program Design) <JY997D55701>	Describes specifications of ladders, ST, FBD/LD, and other programs and labels.
MELSEC iQ-F FX5 Programming Manual (Instructions, Standard Functions/Function Blocks) <JY997D55801>	Describes specifications of instructions and functions that can be used in programs.
MELSEC iQ-F FX5 User's Manual (Serial Communication) <JY997D55901>	Describes N:N network, MELSEC Communication protocol, inverter communication, non-protocol communication, and predefined protocol support.
MELSEC iQ-F FX5 User's Manual (MODBUS Communication) <JY997D56101> (This manual)	Describes MODBUS serial communication.
MELSEC iQ-F FX5 User's Manual (Ethernet Communication) <JY997D56201>	Describes the functions of the built-in Ethernet port communication function.
MELSEC iQ-F FX5 User's Manual (SLMP) <JY997D56001>	Explains methods for the device that is communicating with the CPU module by SLMP to read and write the data of the CPU module.
MELSEC iQ-F FX5 User's Manual (Positioning Control) <JY997D56301>	Describes the built-in positioning function.
MELSEC iQ-F FX5 User's Manual (Analog Control) <JY997D60501>	Describes the analog function.
GX Works3 Operating Manual <SH-081215ENG>	System configuration, parameter settings, and online operations of GX Works3.

TERMS

Unless otherwise specified, this manual uses the following terms.

- indicates a variable part to collectively call multiple models or versions.

(Example) FX5U-32MR/ES, FX5U-32MT/ES ⇒ FX5U-32M□/ES

- For details on the FX3 devices that can be connected with the FX5, refer to FX5 User's Manual (Hardware).

Terms	Description
■Devices	
FX5	Generic term for FX5U and FX5UC PLCs
FX3	Generic term for FX3S, FX3G, FX3GC, FX3U, and FX3UC PLCs
FX5 CPU module	Generic term for FX5U CPU module and FX5UC CPU module
FX5U CPU module	Generic term for FX5U-32MR/ES, FX5U-32MT/ES, FX5U-32MT/ESS, FX5U-64MR/ES, FX5U-64MT/ES, FX5U-64MT/ESS, FX5U-80MR/ES, FX5U-80MT/ES, and FX5U-80MT/ESS
FX5UC CPU module	Generic term for FX5UC-32MT/D and FX5UC-32MT/DSS
Extension module	Generic term for FX5 extension modules and FX3 function modules
• FX5 extension module	Generic term for I/O modules, FX5 extension power supply module, and FX5 intelligent function module
• FX3 extension module	Generic term for FX3 extension power supply module and FX3 intelligent function module
Extension module (extension cable type)	Input modules (extension cable type), Output modules (extension cable type), Bus conversion module (extension cable type), and Intelligent function modules
Extension module (extension connector type)	Input modules (extension connector type), Output modules (extension connector type), Input/output modules, Bus conversion module (extension connector type), and Connector conversion module (extension connector type)
I/O module	Generic term for input modules, output modules, Input/output modules, and powered input/output modules
Input module	Generic term for Input modules (extension cable type) and Input modules (extension connector type)

Terms	Description
• Input module (extension cable type)	Generic term for FX5-8EX/ES and FX5-16EX/ES
• Input module (extension connector type)	Generic term for FX5-C32EX/D and FX5-C32EX/DS
Output module	Generic term for output modules (extension cable type) and output modules (extension connector type)
• Output module (extension cable type)	Generic term for FX5-8EYR/ES, FX5-8EYT/ES, FX5-8EYT/ESS, FX5-16EYR/ES, FX5-16EYT/ES, and FX5-16EYT/ESS
• Output module (extension connector type)	Generic term for FX5-C32EYT/D and FX5-C32EYT/DSS
Input/output modules	Generic term for FX5-C32ET/D and FX5-C32ET/DSS
Powered input/output module	Generic term for FX5-32ER/ES, FX5-32ET/ES, and FX5-32ET/ESS
Extension power supply module	Generic term for FX5 extension power supply module and FX3 extension power supply module
• FX5 extension power supply module	Different name for FX5-1PSU-5V
• FX3 extension power supply module	Different name for FX3U-1PSU-5V
Intelligent module	The abbreviation for intelligent function modules
Intelligent function module	Generic term for FX5 intelligent function modules and FX3 intelligent function modules
• FX5 intelligent function module	Generic term for FX5 intelligent function modules
• FX3 intelligent function module	Different name for FX3 special function blocks
Simple motion module	Different name for FX5-40SSC-S
Expansion board	Generic term for board for FX5U CPU module
• Communication board	Generic term for FX5-232-BD, FX5-485-BD, and FX5-422-BD-GOT
Expansion adapter	Generic term for adapter for FX5 CPU module
• Communication adapter	Generic term for FX5-232ADP and FX5-485ADP
• Analog adapter	Generic term for FX5-4AD-ADP and FX5-4DA-ADP
Bus conversion module	Generic term for FX5-CNV-BUS and FX5-CNV-BUSC
Battery	Different name for FX3U-32BL
Peripheral device	Generic term for engineering tools and GOTs
GOT	Generic term for Mitsubishi Graphic Operation Terminal GOT1000 and GOT2000 series
■Software packages	
Engineering tool	The product name of the software package for the MELSEC programmable controllers
GX Works3	The product name of the software package, SWnDND-GXW3, for the MELSEC programmable controllers (The 'n' represents a version.)
■Manuals	
User's manual	Generic term for separate manuals
• User's manual (Startup)	Abbreviation of MELSEC iQ-F FX5 User's Manual (Startup)
• FX5 User's manual (Hardware)	Generic term for MELSEC iQ-F FX5U User's Manual (Hardware) and MELSEC iQ-F FX5UC User's Manual (Hardware)
• FX5U User's manual (Hardware)	Abbreviation of MELSEC iQ-F FX5U User's Manual (Hardware)
• FX5UC User's manual (Hardware)	Abbreviation of MELSEC iQ-F FX5UC User's Manual (Hardware)
• User's manual (Application)	Abbreviation of MELSEC iQ-F FX5 User's Manual (Application)
Programming manual (Program Design)	Abbreviation of MELSEC iQ-F FX5 Programming Manual (Program Design)
Programming manual (Instructions, Standard Functions/Function Blocks)	Abbreviation of MELSEC iQ-F FX5 Programming Manual (Instructions, Standard Functions/Function Blocks)
Communication manual	Generic term for MELSEC iQ-F FX5 User's Manual (Serial Communication), MELSEC iQ-F FX5 User's Manual (MODBUS Communication), MELSEC iQ-F FX5 User's Manual (Ethernet Communication), and MELSEC iQ-F FX5 User's Manual (SLMP)
• Serial communication manual	Abbreviation of MELSEC iQ-F FX5 User's Manual (Serial Communication)
• MODBUS communication manual	Abbreviation of MELSEC iQ-F FX5 User's Manual (MODBUS Communication)
• Ethernet communication manual	Abbreviation of MELSEC iQ-F FX5 User's Manual (Ethernet Communication)
• SLMP manual	Abbreviation of MELSEC iQ-F FX5 User's Manual (SLMP)
■Communication-related	
Built-in RS-485 port	CPU module built-in RS-485 port
Serial port	Generic name for FX5 CPU module built-in RS-485 port (CH1), communication board (CH2), communication adapter 1 (CH3), communication adapter 2 (CH4) (4 ports)

1 OUTLINE

This chapter explains the FX5 MODBUS serial communication.

- When predefined protocol support function is used, refer to the  MELSEC iQ-F FX5 User's manual (Serial communication).

1.1 Outline of Function

The FX5 MODBUS serial communication function can control 32 slaves for RS-485 communication and one slave for RS-232C communication by a single master.

- The master function and slave function are supported and the master and slave can be used simultaneously by a single FX5. (Only one channel for the master)
- Up to 4 channels can be used for MODBUS serial communication function by one CPU module.
- The master uses a PLC command dedicated to MODBUS serial communication and controls the slave.
- The communication protocol supports the RTU mode.

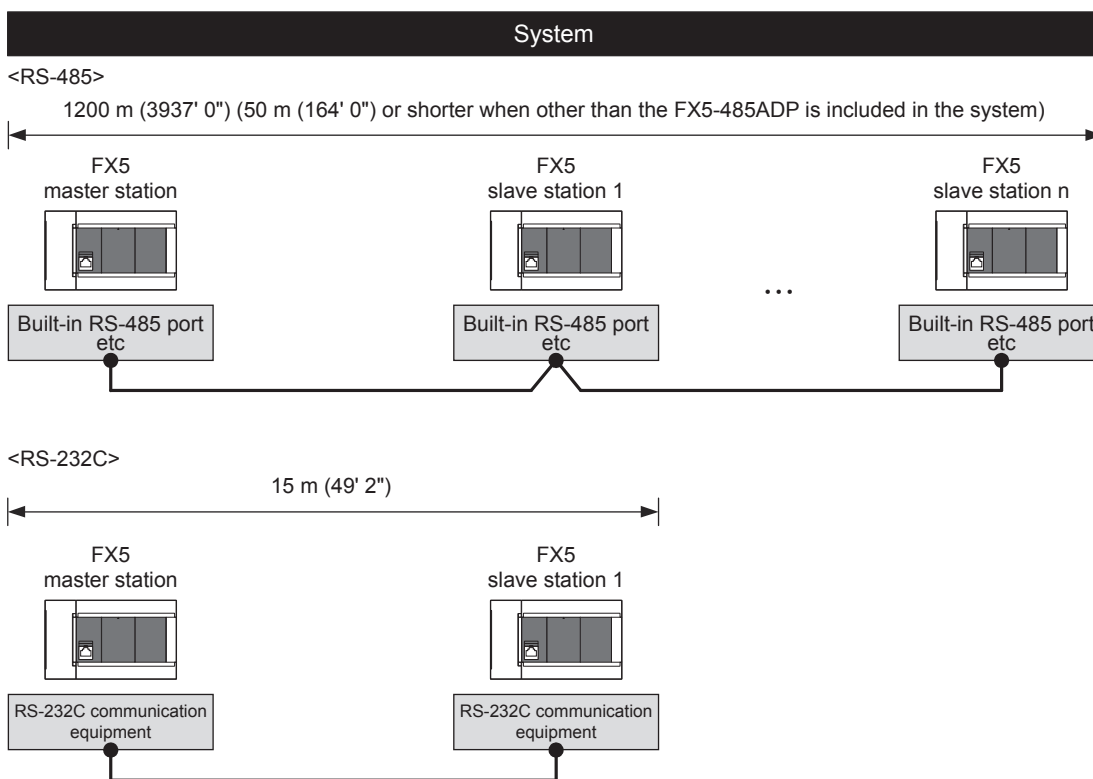

Point

The slave station No. can be arbitrarily assigned.

- If FX5 is used as the master station, slave station No 1 to 32 can be addressed.
- If FX5 is used as a slave station, 1 to 247 can be set for the slave station No.

1.2 Procedure for Operation

The flow chart below shows the procedure for setting up a MODBUS serial communication network:

1. Check communication specifications

☞ Refer to Page 14 SPECIFICATIONS or Page 18 MODBUS COMMUNICATION SPECIFICATIONS

- Communication Specifications

Link Time

- MODBUS Serial Communication Specifications

MODBUS Serial Communication Protocol, Details of MODBUS Standard Functions

2. System configuration and selection

☞ Refer to Page 12 CONFIGURATION

- System Configuration

Selection of communication equipment

3. Wiring

☞ Refer to Page 20 WIRING

- Wiring procedure

Wiring example

4. Communication settings

☞ Refer to Page 25 COMMUNICATION SETTING

- Communication setting using GX Works3

*1 For details on the connection method or operation method to the PLC of GX Works3, refer to the following manual.

☞ GX Works3 Operating Manual

5. Program creation

☞ Refer to Page 30 FUNCTION or Page 41 CREATING PROGRAMS

- Function

Master Function, Slave Function, Related special device

- MODBUS serial communication program

Example of creating programs of the master using ADPRW instruction

2 CONFIGURATION

This chapter explains the configuration of RS-485 and RS-232C communication of the FX5.

2.1 System Configuration

This section outlines the system configuration required to use MODBUS serial communication.

FX5U CPU module

In FX5U CPU module, up to four communication port channels can be connected to a CPU module using built-in RS-485 port, communication board, and communication adapter.

The communication channel assignments are fixed to the following numbers, regardless of the system configuration.

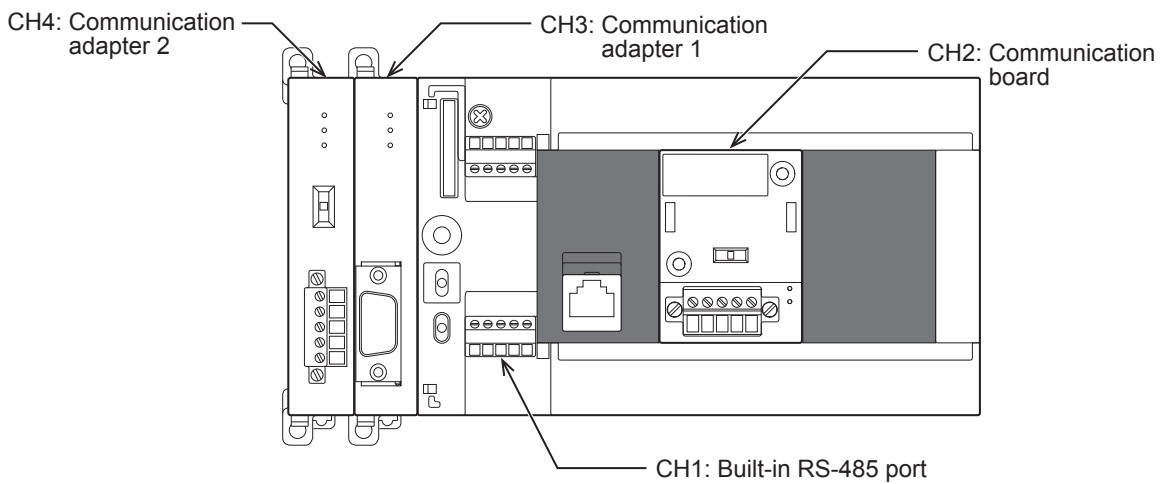

		Communication port	Important point in selection	Total extension distance
Built-in RS-485 port		CH1	Since it is built-into the CPU module, there is no need to add equipment	50 m (164' 0") or less
Communication board	FX5-485-BD	CH2	Mounted on top of the CPU module, there is no change in the installation space requirements	50 m (164' 0") or less
	FX5-232-BD			15 m (49' 2") or less
Communication adapter	FX5-485ADP	CH3, CH4*1	Mount the communication adapter to the left of the CPU module	1200 m (3937' 0") or less
	FX5-232ADP			15 m (49' 2") or less

*1 Assigned to CH3 or CH4 in order of proximity to CPU module.

FX5UC CPU module

In FX5UC CPU module, up to three communication port channels can be connected to a CPU module using built-in RS-485 port, and communication adapter.

The communication channel assignments are fixed to the following numbers, regardless of the system configuration.

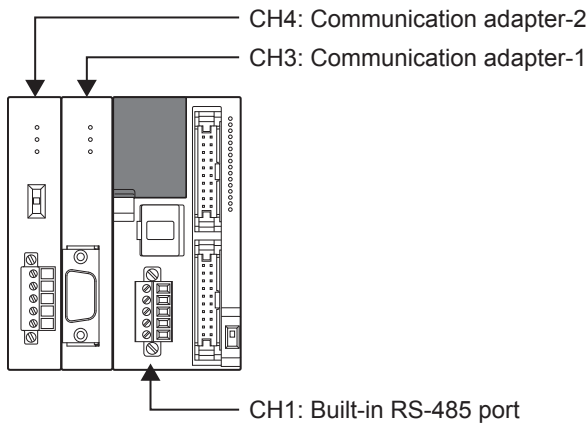

		Communication port	Important point in selection	Total extension distance
Built-in RS-485 port		CH1	Since it is built-into the CPU module, there is no need to add equipment	50 m (164' 0") or less
Communication adapter	FX5-485ADP	CH3, CH4*1	Mount the communication adapter to the left of the CPU module	1200 m (3937' 0") or less
	FX5-232ADP			15 m (49' 2") or less

*1 Assigned to CH3 or CH4 in order of proximity to CPU module.

3 SPECIFICATIONS

This chapter explains the specifications of MODBUS serial communication.

3.1 Communication Specifications

MODBUS serial communication is executed within the specifications shown in the table below. The baud rate, etc. can be changed in the parameter settings of GX Works3.

Item	Specifications		Remarks	
	Built-in RS-485 port FX5-485-BD FX5-485ADP	FX5-232-BD FX5-232ADP		
Number of connectable units	Up to 4 Channel (Only one channel for the master)		The channel can be used as master or slave.	
Communication specifications	Communication interface	RS-485	RS-232C	—
	Baud rate	300/600/1200/2400/4800/9600/19200/38400/57600/115200 bps		—
	Data length	8 bit		—
	Stop bit	1 bit/2 bit		—
	Transmission distance	1200 m (3937' 0") or less for the system configured with FX5-485ADP only 50 m (164' 0") or less for the system configured with devices other than above	15 m (49' 2") or less	The transmission distance varies depending on communication equipment type.
	Communication protocol	RTU		—
Master function	Number of connectable slaves	32 slaves	1 slave	The number of slaves varies depending on communication equipment type.
	Number of functions	8 (No diagnosis function)		—
	Number of simultaneous sending messages	1 message		—
	Maximum number of writes	123 words or 1968 coils		—
	Maximum number of reads	125 words or 2000 coils		—
Slave function	Number of functions	8 (No diagnosis function)		—
	Number of messages which can be received simultaneously	1 message		—
	Station number	1 to 247		—

3.2 Link Time

The link time indicates the cycle time in which a master module completes a single instruction with a slave, as illustrated by the diagram below.

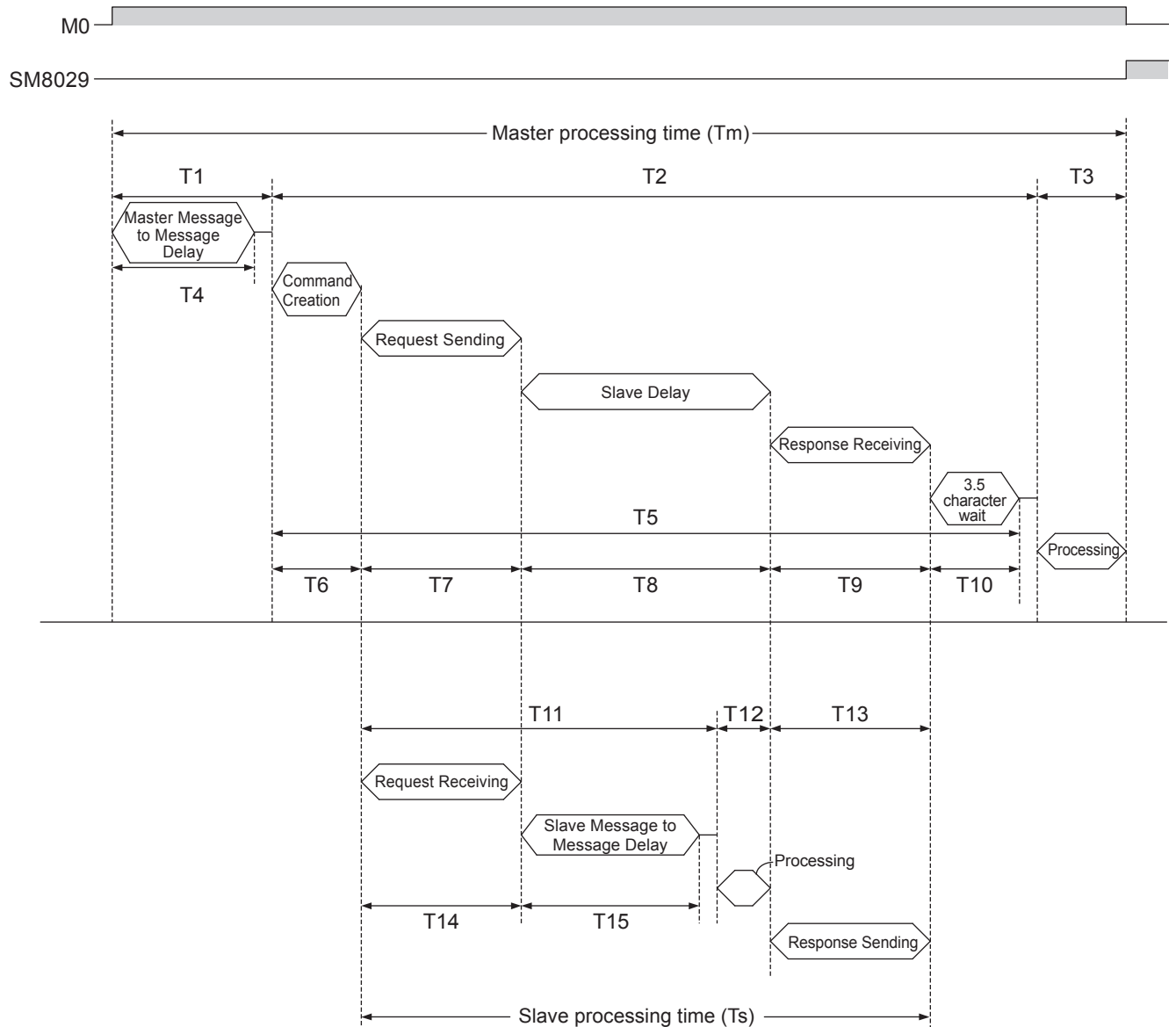
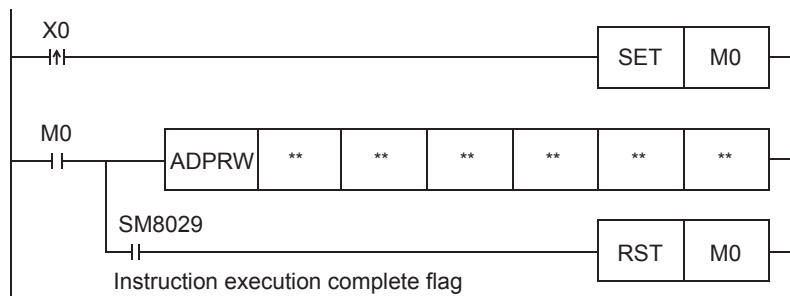

The master processing time (T_m) can be calculated in milliseconds (ms) as follows. "INT(n)" indicates an integer obtained by truncating decimal places of "n".

Character length (bits):

Start bit (1 bit) + Data Length (8 bit) + Parity bit (0 bit or 1 bit) + Stop bit (1 bit or 2 bit)

$$T_m = T_1 + T_2 + T_3$$

$$T_1 = \left(\text{INT} \left(\frac{T_4}{\text{Max. Scan Time}} \right) + 1 \right) \times \text{Max. Scan Time}$$

T₄ = SD8864, SD8874, SD8884, or SD8894 (depending on the communication channel)

$$T_2 = \left(\text{INT} \left(\frac{T_5}{\text{Max. Scan Time}} \right) + 1 \right) \times \text{Max. Scan Time}$$

T₅ = T₆ + T₇ + T₈ + T₉ + T₁₀

T₆ = less than 1 ms

$$T_7 = \frac{\text{Number of Bytes in Request} \times \text{Character Length (bits)}}{\text{Baud Rate (bps)}} \times 1000 \text{ (ms)} + 1 \text{ ms}$$

T₈ = Slave delay time (depending on the slave)

$$T_9 = \frac{\text{Number of Bytes in Response} \times \text{Character Length (bits)}}{\text{Baud Rate (bps)}} \times 1000 \text{ (ms)} + 1 \text{ ms}$$

$$T_{10} = \frac{3.5 \text{ Characters} \times \text{Character Length (bits)}}{\text{Baud Rate (bps)}} \times 1000 \text{ (ms)} + 1 \text{ ms}$$

T₃ = less than 1 ms

The slave processing time (T_s) can be calculated in milliseconds (ms) as follows.

Character length (bits):

Start bit (1 bit) + Data Length (8 bit) + Parity bit (0 bit or 1 bit) + Stop bit (1 bit or 2 bit)

$$T_s = T_{11} + T_{12} + T_{13}$$

$$T_{11} = T_{14} + T_{15} + \text{Max. Scan Time}$$

$$T_{14} = \frac{\text{Number of Bytes in Request} \times \text{Character Length (bits)}}{\text{Baud Rate (bps)}} \times 1000 \text{ (ms)} + 1 \text{ ms}$$

T₁₅ = SD8864, SD8874, SD8884, or SD8894 (depending on the communication channel)

T₁₂ = less than 1 ms

$$T_{13} = \frac{\text{Number of Bytes in Response} \times \text{Character Length (bits)}}{\text{Baud Rate (bps)}} \times 1000 \text{ (ms)} + 1 \text{ ms}$$

Example link time calculations:

Master processing time (T_m)

SD8864	=	5 ms
Max. scan time	=	5 ms
Function	=	Read holding registers 0 to 9 (function code: 03H)
Frame mode	=	RTU mode
Number of bytes in request	=	8 bytes (1 byte Address, 5 byte Frame, 2 byte CRC)
Number of bytes in response	=	25 bytes (1 byte Address echo, 22 byte Frame, 2 byte CRC)
Character length	=	10 bits (1 bit Start bit, 8 bit Data length, 0 bit Parity bit, 1 bit Stop bit)
Baud rate	=	19.2 kbps
Slave delay time	=	10 ms

$$T4 = 5 \text{ ms}$$

$$T1 = \left(\text{INT} \left(\frac{5 \text{ ms}}{5 \text{ ms}} \right) + 1 \right) \times 5 \text{ ms} = (1 + 1) \times 5 \text{ ms} = 10 \text{ ms}$$

$$T6 \approx 1 \text{ ms}$$

$$T7 = \frac{8 \text{ Bytes} \times 10 \text{ Bits}}{19200 \text{ bps}} \times 1000 \text{ (ms)} + 1 \text{ ms} \approx 5.2 \text{ ms}$$

$$T8 = 10 \text{ ms}$$

$$T9 = \frac{25 \text{ Bytes} \times 10 \text{ Bits}}{19200 \text{ bps}} \times 1000 \text{ (ms)} + 1 \text{ ms} \approx 14.0 \text{ ms}$$

$$T10 = \frac{3.5 \text{ Characters} \times 10 \text{ Bits}}{19200 \text{ bps}} \times 1000 \text{ (ms)} + 1 \text{ ms} \approx 2.8 \text{ ms}$$

$$T5 = 1 \text{ ms} + 5.2 \text{ ms} + 10 \text{ ms} + 14.0 \text{ ms} + 2.8 \text{ ms} = 33 \text{ ms}$$

$$T2 = \left(\text{INT} \left(\frac{33 \text{ ms}}{5 \text{ ms}} \right) + 1 \right) \times 5 \text{ ms} = (6 + 1) \times 5 \text{ ms} = 35 \text{ ms}$$

$$T3 \approx 1 \text{ ms}$$

$$T_m = 5 \text{ ms} + 35 \text{ ms} + 1 \text{ ms} = \underline{41 \text{ ms}}$$

Slave processing time (T_s)

Function	=	Read holding registers 0 to 9 (function code: 03H)
Frame mode	=	RTU mode
Number of bytes in request	=	8 bytes (1 byte Address, 5 byte Frame, 2 byte CRC)
Number of bytes in response	=	25 bytes (1 byte Address echo, 22 byte Frame, 2 byte CRC)
Character length	=	10 bits (1 bit Start bit, 8 bit Data length, 0 bit Parity bit, 1 bit Stop bit)
Baud rate	=	19.2 kbps
SD8864	=	5 ms
Max. scan time	=	5 ms

$$T14 = \frac{8 \text{ Bytes} \times 10 \text{ Bits}}{19200 \text{ bps}} \times 1000 \text{ (ms)} + 1 \text{ ms} \approx 5.2 \text{ ms}$$

$$T15 = 5 \text{ ms}$$

$$T11 = 5.2 \text{ ms} + 5 \text{ ms} + 5 \text{ ms} = 15.2 \text{ ms}$$

$$T12 \approx 1 \text{ ms}$$

$$T13 = \frac{25 \text{ Bytes} \times 10 \text{ Bits}}{19200 \text{ bps}} \times 1000 \text{ (ms)} + 1 \text{ ms} \approx 14.0 \text{ ms}$$

$$T_s = 15.2 \text{ ms} + 1 \text{ ms} + 14.0 \text{ ms} = \underline{30.2 \text{ ms}}$$

4 MODBUS COMMUNICATION SPECIFICATIONS

This chapter explains the details of MODBUS Protocol for MODBUS communication and the MODBUS standard functions supported by the FX5.

- For the list of supported MODBUS standard functions, refer to [Page 19](#) List of supported MODBUS standard functions.
- For usage of the supported MODBUS standard functions, refer to [Page 30](#) FUNCTION.

4.1 MODBUS Protocol

The following shows the frame specifications for the MODBUS protocol.

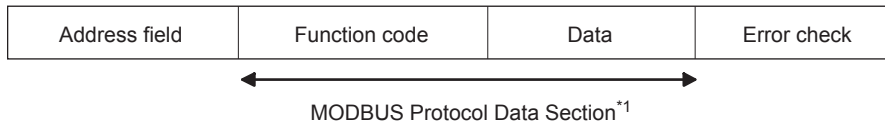

*1 For details of the MODBUS protocol data section, refer to [Page 55](#).

The following table details the frame specifications for the MODBUS Protocol.

Area name	Description
Address field	[When the master sends a request message to a slave] 0: Sends a request message to all the slaves. (Broadcast) 1 to 247: Sends a request to a specific Slave number. Note: 247 is the MODBUS maximum address number. When using the FX5 as master, stations 1 to 32 can be addressed. [When the slave sends a response message to the master] The host station number is stored when sending a response message.
Function code	[When the master sends a request message to a slave] The master specifies the function code to the slave. [When the slave sends a response message to the master] The requested function code is stored in the case of normal completion. The most significant bit turns ON in the case of abnormal end.
Data	[When the master sends a request message to a slave] The information needed to execute the action specified by a function code is stored. [When the slave sends a response message to the master] The execution result of the action specified by a function code is stored. An exception code is stored when failed.
Error check	The node (master or slave) adds the check code automatically to all transmitted messages and recalculates the check code for any received message. The received message is discarded if it has an error.

Refer to [Page 19](#) Frame mode for the data size of each area.

Frame mode

For the FX5, the following frame modes are available. If the frame mode of the FX5 differs from the one of the target device, it cannot be used.

Available frame modes

■RTU mode

In this mode, frames are received or sent in binary codes.

The frame specifications are compliant with the MODBUS protocol specifications.

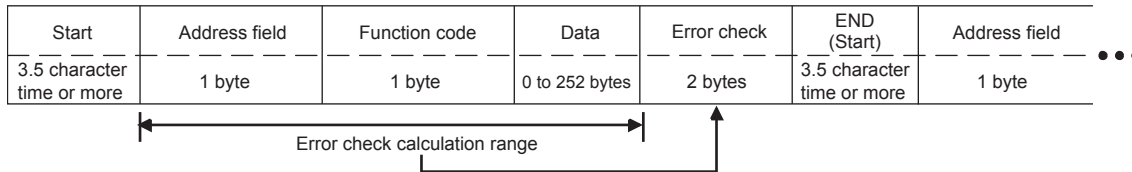

Point

The error check in the RTU mode is conducted by CRC (Cyclic Redundancy Check). The CRC field is two bytes, containing a 16 bit binary value. The CRC value is calculated by the transmitting device, which appends the CRC to the message. The device that receives recalculates a CRC during receipt of the message, and compares the calculated value to the actual value it received in the CRC field. If the two values are not equal, an error occurs. (For procedure for generating of CRC, refer to Page 45 The frame specifications of RTU mode)

List of supported MODBUS standard functions

The following table lists the MODBUS standard functions supported by the FX5.

Function code	Function Name	Details	Accessible devices per message	Broadcast	Reference
01H	Read coils	Read binary (R/W) devices	1 to 2000 points	×	Page 48
02H	Read inputs	Read binary (RO) devices	1 to 2000 points	×	Page 49
03H	Read holding registers	Read 16 bit (R/W) registers	1 to 125 points	×	Page 50
04H	Read input registers	Read 16 bit (RO) registers	1 to 125 points	×	Page 51
05H	Write single coil	Write single binary device	1 point	○	Page 52
06H	Write single register	Write single 16 bit register device	1 point	○	Page 52
0FH	Write multiple coils	Write multiple binary (R/W) devices	1 to 1968 points	○	Page 53
10H	Write multiple registers	Write multiple 16 bit (R/W) registers	1 to 123 points	○	Page 54

○:Applicable, ×:Not applicable

5 WIRING

This chapter explains the wiring.

5.1 Wiring Procedure

1. Preparing for wiring

Prepare cables required for wiring. (☞ Page 20 Selecting Connection)

2. Turning off the power to the PLC

Before wiring, make sure that the power of the PLC is off.

3. Wiring communication equipment

Connect RS-485 or RS-232C communication equipment. (☞ Page 23 Connection Diagram)

5.2 Selecting Connection

Select cables using the procedure described below.

For RS-232C

Use an RS-232C cable of the RS-232 standard within 15 m (49' 2").

For RS-485

Use shielded twisted pair cables for connecting RS-485 communication equipment.

Twisted pair cable

■RS-485 cable specifications

Item	Description
Cable type	Shielded cable
Number of pairs	2p, 3p
Conductor resistance (20°C)	88.0 Ω/km or less
Insulation resistance	10000 MΩ·km or more
Dielectric strength	500 V DC, 1 minute
Electrostatic capacitance (1 kHz)	60 nF/km or less as an average
Characteristic impedance (100 kHz)	110±10 Ω

■Cable structural drawing (reference)

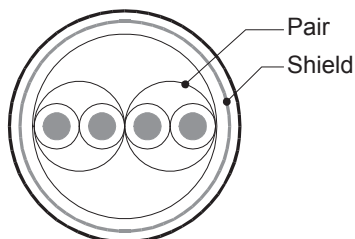

Example of two-pair cable structural drawing

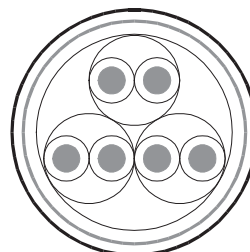

Example of three-pair cable structural drawing

Connecting cables

The table below shows applicable cables and tightening torques.

	Number of connected electric wires per terminal	Cable size		Tightening torque
		Solid wire, Stranded wire	Wire ferrule with insulating sleeve	
FX5U CPU module built-in RS-485 port	1-wire connection	0.2 to 0.5 mm ² (AWG24 to 20)	0.2 to 0.5 mm ² (AWG24 to 20)	0.22 to 0.25 N·m
	2-wire connection	0.2 mm ² (AWG24)	—	
FX5UC CPU module built-in RS-485 port FX5-485-BD FX5-485ADP	1-wire connection	0.3 to 0.5 mm ² (AWG22 to 20)	0.3 to 0.5 mm ² (AWG22 to 20)	
	2-wire connection	0.3 mm ² (AWG22)	—	

Precautions

Do not tighten terminal screws with torque beyond the specified range. Otherwise it may cause equipment failure or malfunction.

Wire end treatment

With regard to the cable end treatment, use a stranded cable or solid cable as is, or use a wire ferrule with insulating sleeve.

■When using a stranded cable or solid cable as is

- Twist the end of stranded wire and make sure that there are no loose wires.
- Please do not solder plate the ends of the wires.

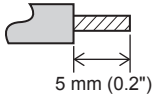
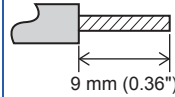
Dimension of the wire end	
FX5U CPU module built-in RS-485 port	FX5UC CPU module built-in RS-485 port, FX5-485-BD, FX5-485ADP
	

■When using a wire ferrule with insulating sleeve

Because it is difficult to insert a cable into the insulating sleeve depending on the thickness of the cable sheath, select the proper cable according to the outline drawing.

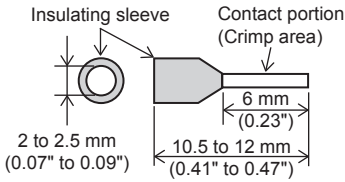
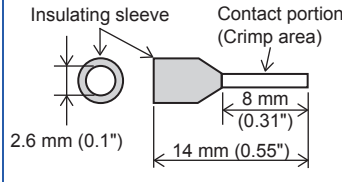
FX5U CPU module built-in RS-485 port	FX5UC CPU module built-in RS-485 port, FX5-485-BD, FX5-485ADP
	

<Reference>

	Manufacturer	Model name	Crimping tool
FX5U CPU module built-in RS-485 port	Phoenix Contact GmbH & Co. KG	AI 0.5-6WH	CRIMPFOX 6
FX5UC CPU module built-in RS-485 port FX5-485-BD FX5-485ADP		AI 0.5-8WH	CRIMPFOX 6T-F

■Tool

For tightening the terminal, use a commercially available small screwdriver with straight tip that is not widened toward the end as shown below.

■Precautions

If the diameter of the screwdriver tip is too small, the required tightening torque cannot be achieved. To achieve the appropriate tightening torque shown in the previous page, use the following screwdriver or its equivalent (grip diameter: approximately 25 mm (0.98")).

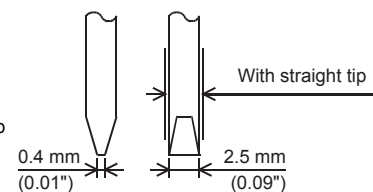

<Reference>

Manufacturer	Model
Phoenix Contact GmbH & Co. KG	SZS 0.4×2.5

Termination resistor setting

Make sure to provide a termination resistor at each end of a line.

Built-in RS-485 port, FX5-485-BD, and FX5-485ADP have a built-in termination resistor.

Set the termination resistor selector switch accordingly.

Wiring	Termination resistor selector switch
Two-pair wiring	330 Ω
One-pair wiring	110 Ω

· FX5U CPU module built-in RS-485 port

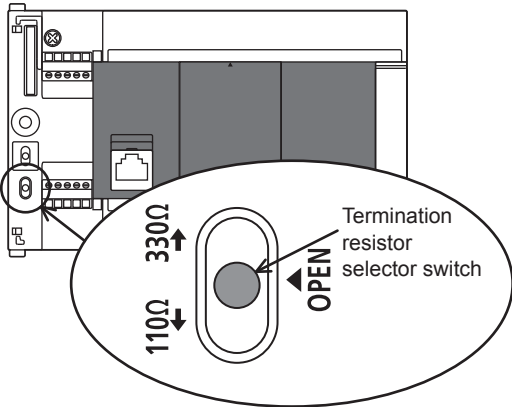

· FX5UC CPU module built-in RS-485 port

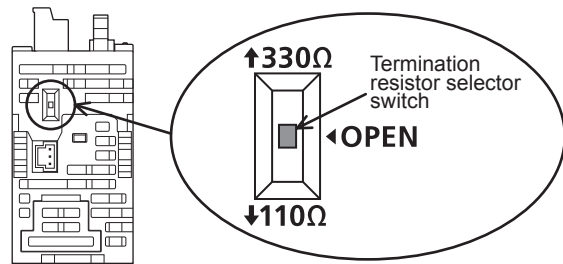

• FX5-485-BD

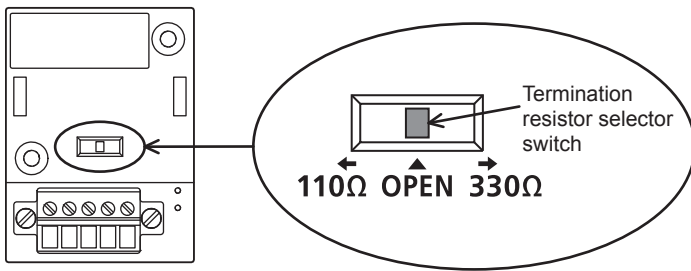

• FX5-485ADP

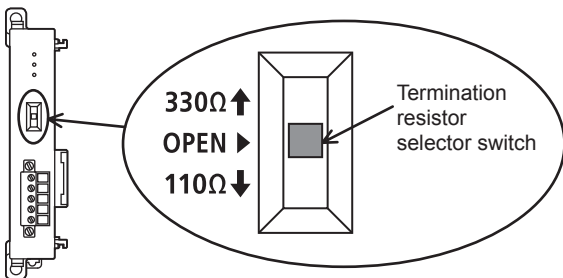

5.3 Connection Diagram

Representative wiring examples are shown in this section. When pin numbers in the counterpart equipment are different, wire the pins as shown below.

Connection diagram for RS-232C

PLC		External equipment operating in accordance with RS-232C					
Name	FX5-232-BD FX5-232ADP 9-pin D-Sub	Using CS and RS		Name	Using DR and ER		
		D-Sub 9-pin	D-Sub 25-pin		D-Sub 9-pin	D-Sub 25-pin	
FG	-		1	FG	-	1	
RD (RXD)	2	2	3	RD (RXD)	2	3	
SD (TXD)	3	3	2	SD (TXD)	3	2	
ER (DTR)	4		4	ER (DTR)	4	20	
SG (GND)	5	5	7	SG (GND)	5	7	
DR (DSR)	6	8	5	DR (DSR)	6	6	

*1 For third-party external equipment requiring the control signal, connect these pins.
The FX5-232-BD, FX5-232ADP does not require these pins to be connected.

Connection diagram for RS-485

One-pair wiring

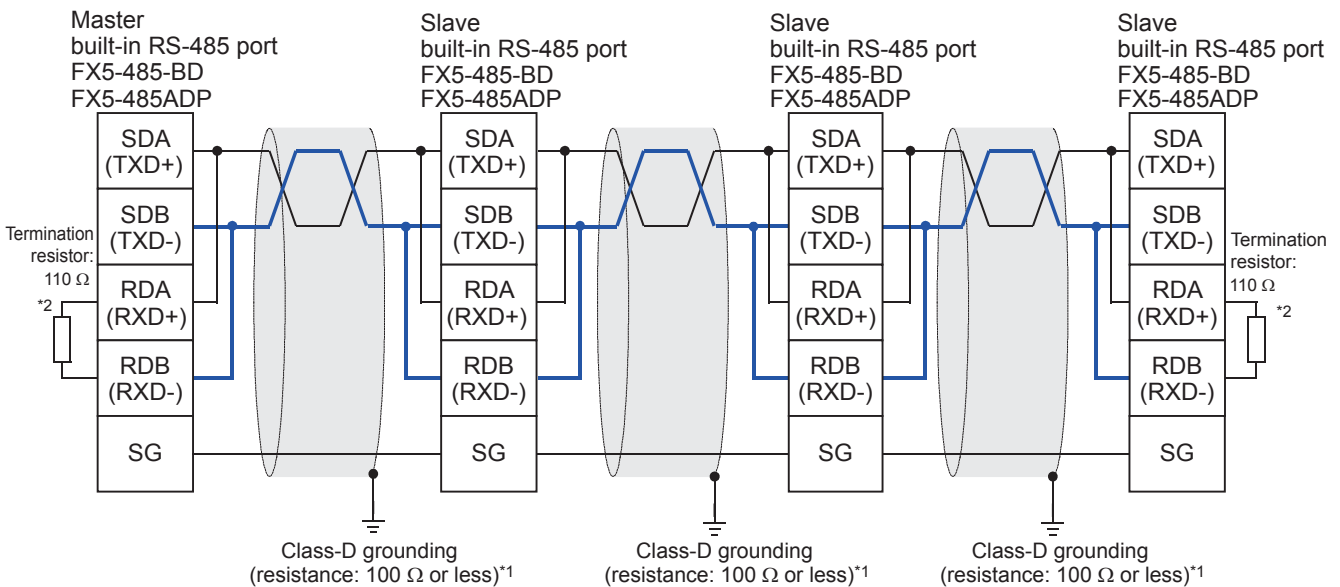

*1 Make sure to perform Class-D grounding on the shield of the twisted pair cable to be connected.

*2 Make sure to provide a termination resistor at each end of a line. Set the selector switch to 110 Ω when the termination resistor is built in.

Two-pair wiring

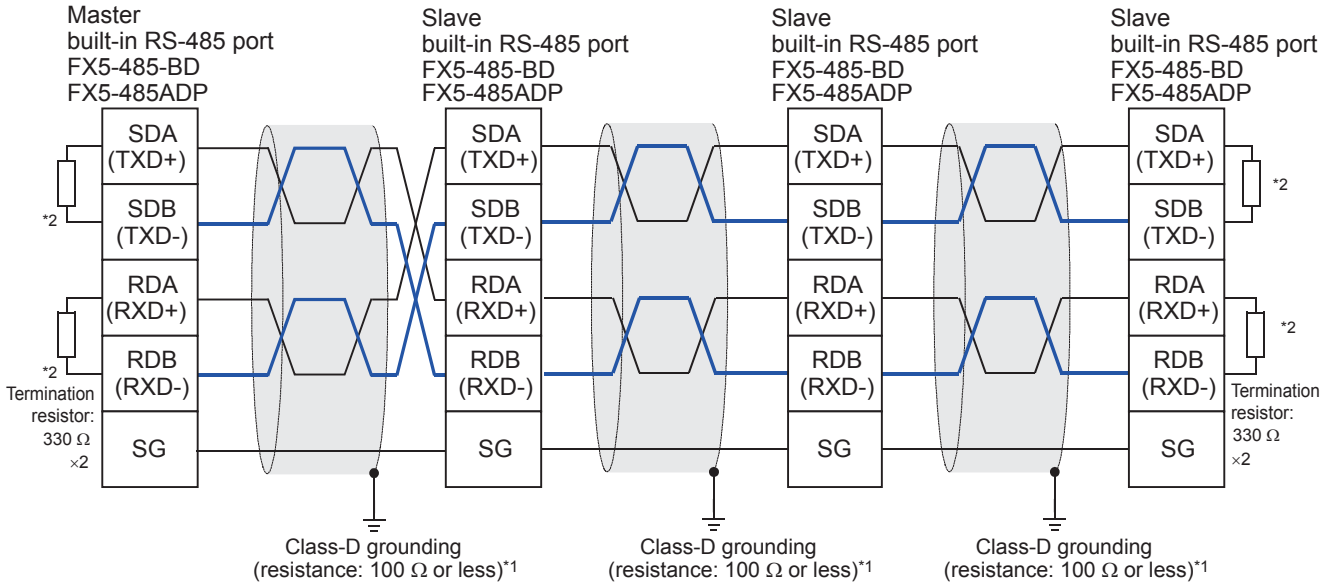

*1 Make sure to perform Class-D grounding on the shield of the twisted pair cable to be connected.

*2 Make sure to provide a termination resistor at each end of a line. Set the selector switch to 330 Ω when the termination resistor is built in.

5.4 Grounding

Grounding should be performed as stated below.

- The grounding should be class D and the resistance should be 100 Ω or less.
- Independent grounding should be performed for best results. When independent grounding cannot be performed, perform "shared grounding" as shown in the following figure

For details, refer to [MELSEC iQ-F FX5U User's Manual \(Hardware\)](#), [MELSEC iQ-F FX5UC User's Manual \(Hardware\)](#).

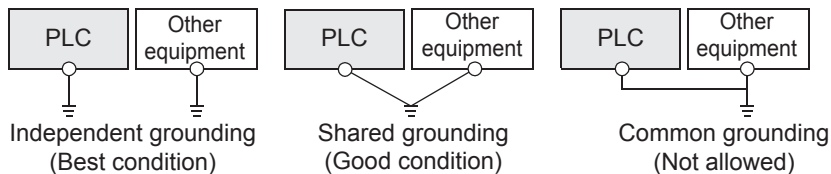

- The grounding wire size should be AWG 14 (2 mm²) or larger.
- The grounding point should be close to the PLC, and all grounding wires should be as short as possible.

6 COMMUNICATION SETTING

This chapter explains the setup method for using MODBUS serial communication with an FX5.

6.1 Setup Method for MODBUS Serial Communication

For the MODBUS serial communication setting of the FX5, set parameters with GX Works3. Setting of parameter differs according to the module used. The procedure for each module is as follows.

Using the CPU module

"Navigation window" ⇒ [Parameter] ⇒ [FX5UCPU] ⇒ [Module Parameter] ⇒ [485 Serial Port]

Window

The following screen will be displayed if "MODBUS_RTU Communication" is set for Communication Protocol Type.

Basic Settings

Item	Setting
Communication Protocol Type	Set communication protocol type.
Communication Protocol Type	MODBUS_RTU Communication
Advanced Settings	Set detailed setting.
Parity Bit	None
Stop Bit	1bit
Baud Rate	115,200bps

Item	Setting	Corresponding station
Communication Protocol Type	MELSOFT Connection, Non-protocol Communication, MC protocol, MODBUS_RTU Communication, Inverter Communication, Predefined protocol support ^{*1}	Master/Slave
Parity Bit	None, Odd, Even	Master/Slave
Stop Bit	1bit, 2bit	Master/Slave
Baud Rate	300bps, 600bps, 1200bps, 2400bps, 4800bps, 9600bps, 19200bps, 38400bps, 57600bps, 115200bps	Master/Slave

*1 When using MODBUS serial communication, select "MODBUS_RTU Communication".

Fixed Setting

Item	Setting
Host Station No.	Set host station No.
Host Station No.	0
Slave Response Timeout	Set the slave response timeout.
Slave Response Timeout	3000 ms
Broadcast Delay	Set the broadcast delay.
Broadcast Delay	400 ms
Message to Message Delay	Set the message to message delay.
Message to Message Delay	1 ms
Timeout Retry Count Setting	Set the timeout retry count setting.
Timeout Retry Count Setting	5

Item	Setting	Corresponding station
Host Station No. ^{*1}	0 to 247 (Master station: 0, Slave station: 1 to 247)	Master/Slave
Slave Response Timeout	1 to 32767 ms	Master/Slave
Broadcast Delay ^{*2}	1 to 32767 ms	Master/Slave
Message to Message Delay	1 to 16382 ms	Master/Slave
Timeout Retry Count Setting	0 to 20	Master/Slave

*1 When set to "Latch" by SM/SD Setting, setting values of the Host Station No. can be changed through special registers. (Page 29 Latch Setting) When other than 0 is set for the special register of a channel that is already set as a master station (station number: 0) by parameter, the channel does not function as a slave station. In addition, when 0 is set for the special register of a channel that is already set as a slave station (station number: 1 to 247) by parameter, the channel does not function as a master station.

*2 Set master station side broadcast delay as equal to one or more scan times of the slave station.

■Modbus Device Assigned

Item	Setting
<input type="checkbox"/> Modbus Device Assigned Device Assigned	Set the assigned to modbus device. <Detailed Setting>

Item	Setting	Corresponding station
Device Assigned	Page 27	Slave

■SM/SD Setting

Item	Setting
<input type="checkbox"/> Latch Setting Advanced Settings Host Station No. Slave Response Timeout Broadcast Delay Message to Message Delay Timeout Retry Count Setting	Set the latch of SM/SD device. Do Not Latch Do Not Latch Do Not Latch Do Not Latch Do Not Latch Do Not Latch
<input type="checkbox"/> FX3 Series Compatibility SM/SD for Compatible	The SM/SD device of FX3 series compatibility. Disable

Item	Setting	Corresponding station
Advanced Settings	Do Not Latch	—
Host Station No.	Do Not Latch, Latch	Master/Slave
Slave Response Timeout	Do Not Latch	—
Broadcast Delay	Do Not Latch	—
Message to Message Delay	Do Not Latch	—
Timeout Retry Count Setting	Do Not Latch	—
SM/SD for Compatible	Disable, CH1, CH2 (Page 29)	Master/Slave

For Latch Setting, refer to Page 29 Latch Setting.

Using an Extended board

"Navigation window" ⇒ [Parameter] ⇒ [FX5UCPU] ⇒ [Module Parameter] ⇒ [Extended Board]

Window

The following screen will be displayed, if Extended Board to be used is set up and "MODBUS_RTU Communication" is set Communication Protocol Type.

■Basic Settings

Item	Setting
<input type="checkbox"/> Extended Board Extended Board	Set the extended board type. FX5-232-BD
<input type="checkbox"/> Communication Protocol Type Communication Protocol Type	Set communication protocol type. MODBUS_RTU Communication
<input type="checkbox"/> Advanced Settings Parity Bit Stop Bit Baud Rate	Set detailed setting. None 1bit 115,200bps

Item	Setting	Corresponding station
Extended Board	None, FX5-232-BD, FX5-485-BD, FX5-422-BD-GOT ^{*1}	Master/Slave
Communication Protocol Type	MELSOFT Connection, Non-protocol Communication, MC protocol, MODBUS_RTU Communication, Inverter Communication ^{*2}	Master/Slave

*1 MODBUS serial communication cannot be used with FX5-422-BD-GOT.

*2 When using MODBUS serial communication, select "MODBUS_RTU Communication".

All screens and setting fields other than extended board are the same as "Using the CPU module". (Page 25)

Using an Expansion adapter

When an expansion adapter is used, add expansion adapter to Module Information.

"Navigation window" ⇒ [Parameter] ⇒ [Module Information] ⇒ "Right-click" ⇒ [Add New Module]

After adding the expansion adapter, make settings on the screen displayed from the following operation.

"Navigation window" ⇒ [Parameter] ⇒ [Module Information] ⇒ [ADP1(or ADP2)] ⇒ [Module Parameter]

Window

Each setting screen is the same as "Using the CPU module". (☞ Page 25)

Contents of parameter setting

The MODBUS device allocation, Latch Setting, SM/SD storage area specification which are used for parameter setting of MODBUS serial communication are as follows.

MODBUS device allocation

In the MODBUS device allocation, initial values are set for parameters. (Refer to ☞ Page 55 FX5 dedicated pattern)

Parameter contents can be changed with following screen of GX Works3.

Window

<Detailed Setting> of "MODBUS Device Assigned" (☞ Page 26) is double-clicked.

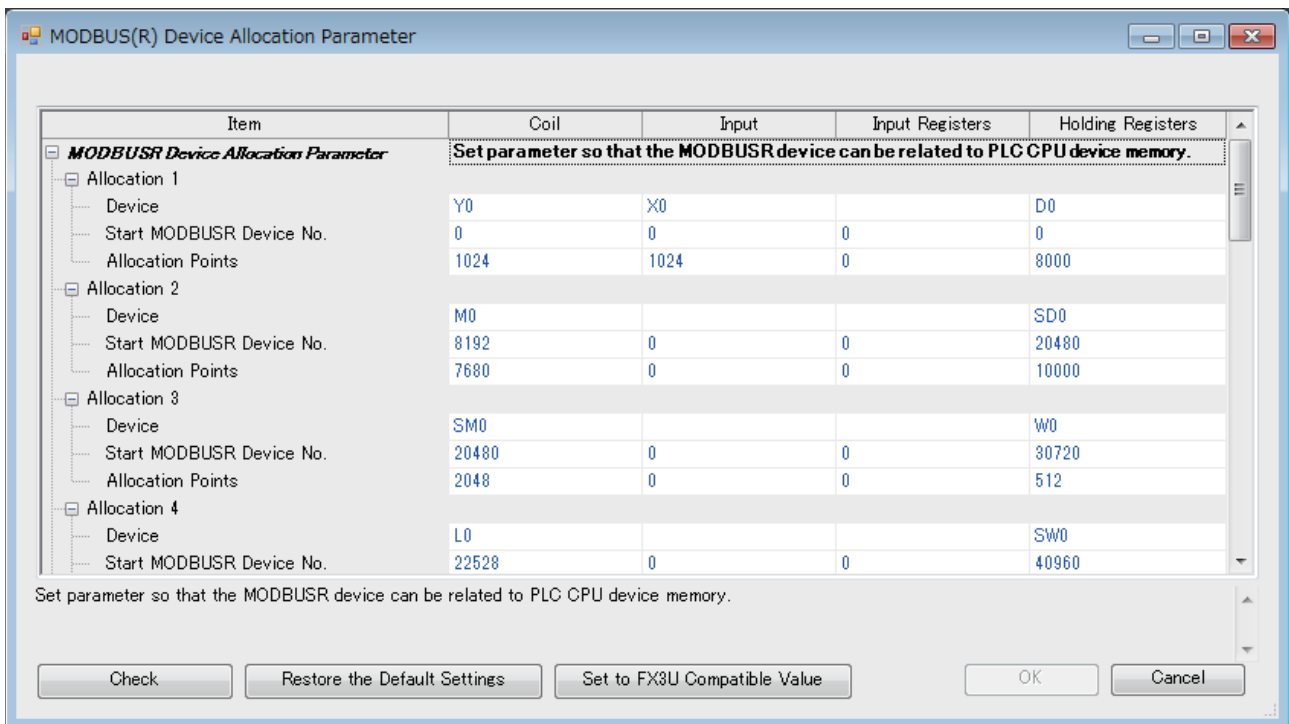

Setting item	Description
Allocation 1 to 16	Allocation of each MODBUS device can be set to 1 to 16.
Device	Set the device type and head number of the device to be allocated.(For available devices, refer to ☞ Page 28 Available devices)
Start MODBUS Device No.	Set the start MODBUS device number.
Allocation Points	Set the number of allocation points.

Available devices

The following table shows devices that can be set to coil, input, input register, and holding register.

List of devices		Allocable MODBUS device				
Device type	Device	Coil	Input	Input register	Holding register	
Special relay	SM	○	○	○*1	○*1	
Special register	SD	—	—	○	○	
Input	X	○	○	○*1	○*1	
Output	Y	○	○	○*1	○*1	
Internal relay	M	○	○	○*1	○*1	
Latch relay	L	○	○	○*1	○*1	
Annunciator	F	○	○	○*1	○*1	
Link relay	B	○	○	○*1	○*1	
Data register	D	—	—	○	○	
Link register	W	—	—	○	○	
Timer	Coil	TC	○	○	○*1	○*1
	Contact	TS	○	○	○*1	○*1
	Current value	TN	—	—	○	○
Retentive timer	Coil	SC	○	○	○*1	○*1
	Contact	SS	○	○	○*1	○*1
	Current value	SN	—	—	○	○
Counter	Coil	CC	○	○	○*1	○*1
	Contact	CS	○	○	○*1	○*1
	Current value	CN	—	—	○	○
Long counter	Coil	LC	○	○	○*1	○*1
	Contact	LS	○	○	○*1	○*1
	Current value	LN	—	—	○*2	○*2
Link special relay	SB	○	○	○*1	○*1	
Link special register	SW	—	—	○	○	
Step relay	S	○	○	○*1	○*1	
Index register	Z	—	—	○	○	
Index register	LZ	—	—	○*2	○*2	
File register	R	—	—	○	○	

*1 Set the device number and the allocating points in multiples of 16. In the case that the number of points is not a multiple of 16, a parameter setting error occurs in GX Works3.

*2 Because MODBUS devices are long type devices, 2 points are allocated.

Precautions

- The same device cannot be set for a coil and an input.
- The same device cannot be set for an input register and a holding register.
- A parameter setting error occurs in GX Works3 when the total of selected head device number and the allocated points exceed the valid range for the selected PLC device.

Latch Setting

In latch setting, it can be set up whether the host number should operate using the GX Works3 parameter or special register.

- In the case of "Do Not Latch", the host number operates using the value set by the parameter setting of GX Works3.
- In the case of "Latch", special relays corresponding to each CH turn on and the host number operates using the value set by special registers. Value of special registers can be changed by program. The following table shows, special relays and special registers corresponding for each channel.

CH	Special relays	Special registers	Corresponding parameter
CH1	SM8861	SD8861	Host station number setting
CH2	SM8871	SD8871	
CH3	SM8881	SD8881	
CH4	SM8891	SD8891	

Point

Setting value of special registers or parameter are reflected when the power supply is turned from off to on or reset.

Precautions

When the SD latch setting valid information is set to off due to memory clear and so on, while special registers are set to "Latch" by the parameter, the parameter setting becomes valid when the power is turned off to on or reset.

SM/SD for FX3 Series compatible

In the FX5, special relays of the FX3 and special registers of the FX3 can be used in the compatibility area.

Channel numbers may differ between the FX3 and the FX5 depending on the configuration. Select whether to use special devices for the corresponding channel number (CH1 or CH2) in this setting.

- When this setting is not configured, SM and SD for FX3 series compatibility are not used.
- When this setting is configured, select CH1 or CH2 SM and SD for FX3 series compatibility.

For the device for FX3 series compatible, refer to the following.

 Page 33 Related Devices

7 FUNCTION

This chapter explains the function of MODBUS serial communication.

7.1 Master Function

In the FX5 master function, communication is executed with the slave station using the ADPRW instruction.

ADPRW

This instruction allows to communicate (read/write data) with the slave station by the function code which is supported by the master.

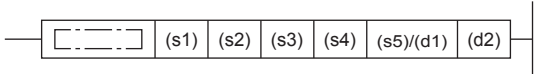
Ladder diagram	Structured text
	<pre>ENO:=ADPRW(EN,s1,s2,s3,s4,s5d1,d2);</pre>

FBD/LD

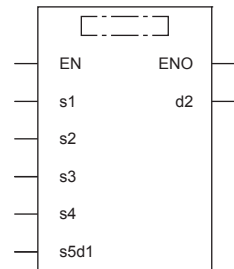

Setting data

■ Descriptions, ranges, data types

Operand	Description	Range	Data type	Data type (label)
(s1)	Slave node address	0 to 20H	16-bit signed binary	ANY16
(s2)	Function code (Refer to Page 31)	01H to 06H, 0FH, 10H	16-bit signed binary	ANY16
(s3)	Function parameter depending on the function code (Refer to Page 31)	0 to FFFFH	16-bit signed binary	ANY16
(s4)	Function parameter depending on the function code (Refer to Page 31)	1 to 2000	16-bit signed binary	ANY16
(s5)/(d1)	Function parameter depending on the function code (Refer to Page 31)	—	Bit/16-bit signed binary	ANY_ELEMENTARY
(d2)*1	Start bit device number to which communication execution status is output	—	Bit	ANYBIT_ARRAY (Number of elements: 3)



*1 Three devices are occupied from the device specified in (d2). Make sure that these devices are not used in other controls.

■ Available devices

Operand	Bit			Word			Double word		Indirect specification	Constant				Others
	X, Y, M, L, SM, F, B, SB	U□\G□	T, ST, C, LC	T, ST, C, D, W, SD, SW, R	U□\G□	Z	LC	LZ		K	H	E	\$	
(s1)	—	—	—	○*1	○	○	—	—	○	○	—	—	—	
(s2)	—	—	—	○*1	○	○	—	—	○	○	—	—	—	
(s3)	—	—	—	○*1	○	○	—	—	○	○	—	—	—	
(s4)	—	—	—	○*1	○	○	—	—	○	○	—	—	—	
(s5)/(d1)	○	—	—	○*1	○	○	—	—	○	○	—	—	—	
(d2)	○	—	—	○*1	—	—	—	—	—	—	—	—	—	

*1 T, ST, C cannot be used.

Processing details

- Function code (s2) is operated on slave node address (s1) according to parameters (s3), (s4), and (s5)/(d1). Use 0 as the slave node address (s1) for broadcast commands. (Refer to  Page 31 Function code and function parameters.)
- The communication execution status (d2) is output according to each status of the ADPRW instruction such as communicating/completed normally/completed with an error. (Refer to  Page 32 Communication execution status output device.)

■Function code and function parameters

The following table shows the parameter allocation of (s3), (s4), and (s5)/(d1) for each function code (s2).

(s2): Function code	(s3): MODBUS address	(s4): Device count	(s5)/(d1): Start device storing data	
	Applicable device: ② (Refer to the following applicable devices.)			
01H Read coils	MODBUS address: 0000H to FFFFH	Device count: 1 to 2000	Start device storing read data	
			Applicable device	Word device ① (Refer to the following table of the applicable devices.) Bit device ③ (Refer to the following table of the applicable devices.)
			Number of occupied points	Word device $((s4) + 15) \div 16 \text{ points}^{*1}$ Bit device (s4) points
02H Read inputs	MODBUS address: 0000H to FFFFH	Device count: 1 to 2000	Start device storing read data	
			Applicable device	Word device ① (Refer to the following table of the applicable devices.) Bit device ③ (Refer to the following table of the applicable devices.)
			Occupied points	Word device $((s4) + 15) \div 16 \text{ points}^{*1}$ Bit device (s4) points
03H Read holding registers	MODBUS address: 0000H to FFFFH	Device count: 1 to 125	Start device storing read data	
			Applicable device	① (Refer to the following table of the applicable devices.)
			Occupied points	(s4) points
04H Read input registers	MODBUS address: 0000H to FFFFH	Device count: 1 to 125	Start device storing read data	
			Applicable device	① (Refer to the following table of the applicable devices.)
			Occupied points	(s4) points
05H Write coils	MODBUS address: 0000H to FFFFH	0 (fixed)	Start device storing write data	
			Applicable device ^{*2}	Word device ② (Refer to the following table of the applicable devices.) Bit device ③ (Refer to the following table of the applicable devices.)
			Occupied points	1 point
06H Write holding registers	MODBUS address: 0000H to FFFFH	0 (fixed)	Start device storing write data	
			Applicable device	② (Refer to the following table of the applicable devices.)
			Occupied points	1 point
0FH Write multiple coils	MODBUS address: 0000H to FFFFH	Device count: 1 to 1968	Start device storing write data	
			Applicable device	Word device ② (Refer to the following table of the applicable devices.) Bit device ③ (Refer to the following table of the applicable devices.)
			Occupied points	Word device $((s4) + 15) \div 16 \text{ points}^{*1}$ Bit device (s4) points
10H Write multiple holding registers	MODBUS address: 0000H to FFFFH	Device count: 1 to 123	Start device storing write data	
			Applicable device	② (Refer to the following table of the applicable devices.)
			Occupied points	(s4) points

*1 Fractions are rounded off.

*2 When the least significant bit is 0, the bit is off. When the least significant bit is 1, the bit is on.

► Applicable device table

No.	Applicable device
①	T, ST, C, D, R, W, SW, SD, label device
②	T, ST, C, D, R, W, SW, SD, label device, K, H
③	X, Y, M, L, B, F, SB, S, SM, label device

■ Communication execution status output device

The following shows the timing of operation of the communication execution status output device (d2) according to each communication status, and the special relays which operate at the same time.

Operand	Timing of operation	Special relay which operates at the same time
(d2)	Turns on while the instruction is executed and turns off in the status other than while the instruction is executed.	SM8800 (CH1), SM8810 (CH2), SM8820 (CH3), SM8830 (CH4)*1
(d2) + 1*2	Turns on when the instruction is completed normally and turns off when the instruction is started.	SM8029
(d2) + 2*2	Turns on when the instruction is completed with an error and turns off when the instruction is started.	SM8029

*1 SM8401 (CH1) or SM8421 (CH2) turn on, when SM/SD for FX3 compatible is set.

*2 (d2) + 1 turns on when the instruction is completed normally and (d2) + 2 turns on when the instruction is completed with an error, so that whether the instruction is completed normally or with an error can be judged.

Precautions

- The channel which uses the ADPRW instruction must be set to the master station by the GX Works3. (Page 25 Fixed Setting) When it is not set, the device does not operate even though the ADPRW instruction is executed. (Also no error occurs.)
- If the program stops due to error, the device value is turned off if a non-latch device is designated as the communication execution status output device. Specify a latch device to keep the communication state output.

7.2 Slave Function

This function performs operations according to the supported function code by communication with the master station. For the supported function codes, refer to  Page 19 List of supported MODBUS standard functions.

7.3 Related Devices

In this section, the functions of the special registers and special relays are described for MODBUS serial communication.

List of related devices

Special relays

The table shows the special relays used for the FX5 MODBUS serial communication.

■Only for FX5

Device number				Name	Valid	Details	R/W
CH1	CH2	CH3	CH4				
SM8500	SM8510	SM8520	SM8530	Serial communication error	Master/ Slave	Turns on when an error occurs during the serial communication.	R
SM8800	SM8810	SM8820	SM8830	During MODBUS serial communication	Master	Turns on when the instruction is started until the instruction execution complete flag is turned on during MODBUS serial communication.	R
SM8801	SM8811	SM8821	SM8831	Retry	Master	Turns on while the master sends retries when the slave fails to respond until timeout setting time.	R
SM8802	SM8812	SM8822	SM8832	Timeout	Master	Turns on if a response timeout occurs.	R
SM8861	SM8871	SM8881	SM8891	Host station number latch setting valid	Slave	Turns on when the latch setting is set to "Latch".	*1

R: Read only, R/W: Read/Write

*1 The devices become R/W when a latch is set and R when a latch is not set.

■For FX3 compatibility

Device number		Name	Valid	Details	R/W
CH1	CH2				
SM8029		Instruction execution complete	Master	Turns on if the processing of an instruction is completed.	R
SM8401	SM8421	During MODBUS communication	Master	Turns on when the instruction is started until the instruction execution complete flag is turned on during MODBUS serial communication.	R
SM8402	SM8422	MODBUS communication error	Master	Turns on when an error occurs during MODBUS serial communication.	R
SM8403	SM8423	MODBUS communication error (latched)	Master/ Slave	Turns on once an error occurs during MODBUS serial communication.	R
SM8063	SM8438	Serial communication error	Master/ Slave	Turns on once an error occurs during MODBUS serial communication.	R
SM8408	SM8428	Retry	Master	Turns on while the master sends retries when the slave fails to respond until timeout setting time.	R
SM8409	SM8429	Timeout	Master	Turns on if a response timeout occurs.	R

R: Read only

Special registers

The table shows the special registers used for the FX5 MODBUS serial communication.

■Only for FX5

Device number				Name	Valid	Details	R/W
CH1	CH2	CH3	CH4				
SD8500	SD8510	SD8520	SD8530	Serial communication error code	Master/ Slave	Stores the current error code generated during serial communication.	R
SD8501	SD8511	SD8521	SD8531	Serial communication error details	Master/ Slave	Stores current error details.	R
SD8502	SD8512	SD8522	SD8532	Serial communication setting	Master/ Slave	Stores the communication properties in the CPU module.	R
SD8503	SD8513	SD8523	SD8533	Serial communication operation mode	Master/ Slave	Stores the mode of serial communication being executed.	R
SD8800	SD8810	SD8820	SD8830	Current retry value	Master/ Slave	Stores the current value of retries of when a communication retry is executed due to slave response timeout.	R
SD8861	SD8871	SD8881	SD8891	Host station number	Master/ Slave	Stores the host station number setting value.	*1
SD8862	SD8872	SD8882	SD8892	Slave response timeout	Master/ Slave	Stores the slave response timeout setting value.	R
SD8863	SD8873	SD8883	SD8893	Broadcast delay	Master/ Slave	Stores the broadcast delay setting value.	R
SD8864	SD8874	SD8884	SD8894	Message to message delay	Master/ Slave	Stores the message to message delay setting value.	R
SD8865	SD8875	SD8885	SD8895	Timeout retry count	Master/ Slave	Stores the timeout retry count setting value.	R

R: Read, R/W: Read/Write

*1 The devices vary depending on the Latch Setting. The device becomes R when the Latch setting is "Do not Latch", and R/W when the Latch setting is "Latch".

■For FX3 compatibility

Device number		Name	Valid	Details	R/W
CH1	CH2				
SD8063	SD8438	Serial communication error code	Master/ Slave	Stores the current error code generated during serial communication.	R
SD8402	SD8422	Communication error code	Master/ Slave	Stores the current error code generated during serial communication.	R
SD8403	SD8423	Error details	Master/ Slave	Stores the current error details.	R
SD8405	SD8425	Communication format setting value	Master/ Slave	Stores the communication parameter set in the CPU module.	R
SD8408	SD8428	Current retry value	Master/ Slave	Stores the current value of retries of when a communication retry is executed due to slave response timeout.	R
SD8419	SD8439	Communication operation mode	Master/ Slave	Stores the communication operation mode in the CPU module.	R

R: Read

Details of Related Devices

The following devices are used in MODBUS serial communication.

The devices of "For FX3 compatibility" operate in the channel which specifies by the SM/SD for FX3 compatibility in communication setting.

Instruction execution complete

This device checks whether the execution of the instruction is completed.

Only for FX5				For FX3 compatibility		Description	R/W
CH1	CH2	CH3	CH4	CH1	CH2		
SM8029						Turns on if the processing of the instruction is completed.	R

R: Read

Point

SM8029 is also used as the execution completed flag for other instructions (such as positioning instructions). When using SM8029, provide the contact just under the instruction whose execution completion is to be checked.

Precautions

Do not turn ON with program or engineering tool.

This device does not turn OFF even if normal communication is restored. The device is cleared when the power supply is turned from off to on, reset, set from STOP to RUN, or the next ADPRW instruction is executed.

During MODBUS communication

This device checks if MODBUS serial communication is being executed.

Only for FX5				For FX3 compatibility		Description	R/W
CH1	CH2	CH3	CH4	CH1	CH2		
SM8800	SM8810	SM8820	SM8830	SM8401	SM8421	Turns on when the instruction is started until the instruction execution complete flag is turned on during MODBUS serial communication.	R

R: Read

Precautions

Do not turn ON with program or engineering tool.

The device is cleared when the power supply is turned from off to on, reset, or set from STOP to RUN.

MODBUS communication error

This device checks if an error occurs during MODBUS serial communication.

For FX3 compatibility		Description	R/W
CH1	CH2		
SM8402	SM8422	Turns on when an error occurs during MODBUS serial communication.	R

R: Read

Precautions

Do not turn ON with program or engineering tool.

This device does not turn OFF even if normal communication is restored. The device is cleared when the power supply is turned from off to on, reset, set from STOP to RUN, SM50 (Error Detection Reset Completion) is turned on, or the next ADPRW instruction is executed.

MODBUS communication error (latched)

This device checks if an error occurs during MODBUS serial communication.

For FX3 compatibility		Description	R/W
CH1	CH2		
SM8403	SM8423	Turns on once an error occurs during MODBUS serial communication.	R

R: Read

Precautions

Do not turn ON with program or engineering tool.

The device is cleared when the power supply is turned from off to on, reset, or set from STOP to RUN.

Serial communication error

This device checks if an error occurs during serial communication.

Only for FX5				For FX3 compatibility		Description	R/W
CH1	CH2	CH3	CH4	CH1	CH2		
SM8500	SM8510	SM8520	SM8530	SM8063	SM8438	Turns on when an error occurs during serial communication.	R

R: Read

Precautions

Do not turn ON with program or engineering tool.

This device do not turn OFF even if normal communication is restored. The device is cleared when the power supply is turned from off to on, reset, set from STOP to RUN, or SM50 (Error Detection Reset Completion) is turned on.

Retry

This device checks if a retry occurs during MODBUS serial communication.

Only for FX5				For FX3 compatibility		Description	R/W
CH1	CH2	CH3	CH4	CH1	CH2		
SM8801	SM8811	SM8821	SM8831	SM8408	SM8428	Turns on while the master sends retries when the slave fails to respond in time.	R

R: Read

Precautions

Do not turn ON with program or engineering tool.

The device is cleared when the power supply is turned from off to on, reset, set from STOP to RUN, SM50 (Error Detection Reset Completion) is turned on, or the next ADPRW instruction is executed.

Timeout

This device checks if a timeout occurs during MODBUS serial communication.

Only for FX5				For FX3 compatibility		Description	R/W
CH1	CH2	CH3	CH4	CH1	CH2		
SM8802	SM8812	SM8822	SM8832	SM8409	SM8429	Turns on if a response timeout occurs.	R

R: Read

Precautions

Do not turn ON with program or engineering tool.

The device is cleared when the power supply is turned from off to on, reset, set from STOP to RUN, SM50 (Error Detection Reset Completion) is turned on, or the next ADPRW instruction is executed.

If the number of retries is 1 or more, the error flag (📄 Page 43 Error flags) is not set until the set number of retries fail by timeout (or another failure).

Host station number SD latch setting valid

The device which set latch valid/invalid of host station number for MODBUS serial communication.

Only for FX5				Description	R/W
CH1	CH2	CH3	CH4		
SM8861	SM8871	SM8881	SM8891	Turns on when host station number setting is "Latch" in MODBUS communication parameter.	*1

R: Read, R/W: Read/Write

*1 The devices vary depending on the Latch Setting. The device becomes R when the Latch setting is "Do not Latch", and R/W when the Latch setting is "Latch".

Precautions

Do not turn ON with program or engineering tool.

The device is set when the power supply is turned from off to on or reset.

Serial communication error code

This device stores the current error codes during serial communication. (📄 Page 43 Error code.)

Only for FX5				For FX3 compatibility		Description	R/W
CH1	CH2	CH3	CH4	CH1	CH2		
SD8500	SD8510	SD8520	SD8530	SD8402 SD8063	SD8422 SD8438	Stores the current error code generated by serial communication.	R

R: Read

Precautions

Do not change the device value using a program or an engineering tool.

The device is cleared when the power supply is turned from off to on, reset, set from STOP to RUN, or SM50 (Error Detection Reset Completion) is turned on, only in the master.

Serial communication error details

This device stores the current error details during serial communication. (📖 Page 43 Error code.)

Only for FX5				For FX3 compatibility		Description	R/W
CH1	CH2	CH3	CH4	CH1	CH2		
SD8501	SD8511	SD8521	SD8531	SD8403	SD8423	Stores the current error details generated during serial communication.	R

R: Read

Precautions

Do not change the device value using a program or an engineering tool.

The device is cleared when the power supply is turned from off to on, reset, set from STOP to RUN, or SM50 (Error Detection Reset Completion) is turned on, only in the master.

Communication format setting value

This device stores the communication format setting value.

Only for FX5				For FX3 compatibility		Description	R/W
CH1	CH2	CH3	CH4	CH1	CH2		
SD8502	SD8512	SD8522	SD8532	SD8405	SD8425	Stores the parameters set by an engineering tool. For details, refer to the following table.	R

R: Read

The following table shows the parameter descriptions of the communication format.

Bit	Name	Description	
		0 (bit = OFF)	1 (bit = ON)
b0	—	—	—
b1, b2	Parity bit	(b2, b1) = (0, 0): None (b2, b1) = (0, 1): Odd (b2, b1) = (1, 1): Even	
b3	Stop bit	1bit	2bit
b4 to b7	Baud rate (bps)	(b7, b6, b5, b4) = (0, 0, 1, 1): 300 (b7, b6, b5, b4) = (0, 1, 0, 0): 600 (b7, b6, b5, b4) = (0, 1, 0, 1): 1200 (b7, b6, b5, b4) = (0, 1, 1, 0): 2400 (b7, b6, b5, b4) = (0, 1, 1, 1): 4800 (b7, b6, b5, b4) = (1, 0, 0, 0): 9600 (b7, b6, b5, b4) = (1, 0, 0, 1): 19200 (b7, b6, b5, b4) = (1, 0, 1, 0): 38400 (b7, b6, b5, b4) = (1, 0, 1, 1): 57600 (b7, b6, b5, b4) = (1, 1, 0, 1): 115200	
b8 to b15	—	—	—

Precautions

Do not change the device value using a program or an engineering tool.

The setting value changes when the power supply is turned from off to on or reset.

Operation mode display

This device stores the operation mode of the serial communication being executed.

Only for FX5				For FX3 compatibility		Description	R/W
CH1	CH2	CH3	CH4	CH1	CH2		
SD8503	SD8513	SD8523	SD8533	SD8419	SD8439	0: MELSOFT Connection 2: MC protocol 3: PLC to PLC to simple link Communication 5: Non-protocol Communication 7: Inverter Communication 9: MODBUS RTU Communication 12: Predefined protocol support Other than above: Not used	R

R: Read

Precautions

Do not change the device value using a program or an engineering tool.
The device is cleared when ADPRW instruction is executed.

Current retry value

This device stores the current retry value.

Only for FX5				For FX3 compatibility		Description	R/W
CH1	CH2	CH3	CH4	CH1	CH2		
SD8800	SD8810	SD8820	SD8830	SD8408	SD8428	Stores the current value of retries executed by the slave response timeout.	R

R: Read

Precautions

Do not change the device value using a program or an engineering tool.
The device is cleared when the power supply is turned from off to on, reset, set from STOP to RUN, SM50 (Error Detection Reset Completion) is turned on, or next ADPRW instruction is executed.

Host station number

This device stores the host station number setting value.

Only for FX5				Description	R/W
CH1	CH2	CH3	CH4		
SD8861	SD8871	SD8881	SD8891	Stores the parameters (host station number) set by a program or an engineering tool. For 0: Master station For 1 to 247: Slave station (station number: 1 to 247)	*1

R: Read, R/W: Read/Write

*1 The devices vary depending on the Latch Setting. The device becomes R when the Latch setting is "Do not Latch", and R/W when the Latch setting is "Latch".

Precautions

■ "Latch"

The device value can be changed by the program.

■ "Do Not latch"

Do not change the device value using a program or an engineering tool.

■ Change "Do Not Latch" to "Latch"

The setting value is reflected when the power supply is turned from off to on or reset, after parameter write from an engineering tool.

Slave response timeout

This device stores the slave response timeout setting value.

Only for FX5				Description	R/W
CH1	CH2	CH3	CH4		
SD8862	SD8872	SD8882	SD8892	Stores the parameters (slave response timeout) set by an engineering tool.	R

R: Read

Precautions

The setting value is reflected when the power supply is turned from off to on, reset, or the next ADPRW instruction is executed.

Broadcast delay

This device stores the broadcast delay setting value.

Only for FX5				Description	R/W
CH1	CH2	CH3	CH4		
SD8863	SD8873	SD8883	SD8893	Stores the parameters (broadcast delay) set by an engineering tool.	R

R: Read

Precautions

The setting value is reflected when the power supply is turned from off to on, reset, or the next ADPRW instruction is executed.

Message to message delay

This device stores the message to message delay setting value.

Only for FX5				Description	R/W
CH1	CH2	CH3	CH4		
SD8864	SD8874	SD8884	SD8894	Stores the parameters (message to message delay) set by an engineering tool.	R

R: Read

Precautions

The setting value is reflected when the power supply is turned from off to on, reset, or the next ADPRW instruction is executed.

Timeout retry count

This stores the timeout retry count setting value.

Only for FX5				Description	R/W
CH1	CH2	CH3	CH4		
SD8865	SD8875	SD8885	SD8895	Stores the parameters (timeout retry count) set by an engineering tool.	R

R: Read

Precautions

The setting value is reflected when the power supply is turned from off to on, reset, or the next ADPRW instruction is executed.

8 CREATING PROGRAMS

This chapter explains an example of creating programs for the master in MODBUS serial communication.

8.1 Creating Programs for the Master Station

Programs allowing the master station to read and write slave station devices can be created as shown in the example below.

For ADPRW instruction, refer to [Page 30 ADPRW](#).

For cautions on program creation, refer to [Page 41 Cautions on Program Creation](#).

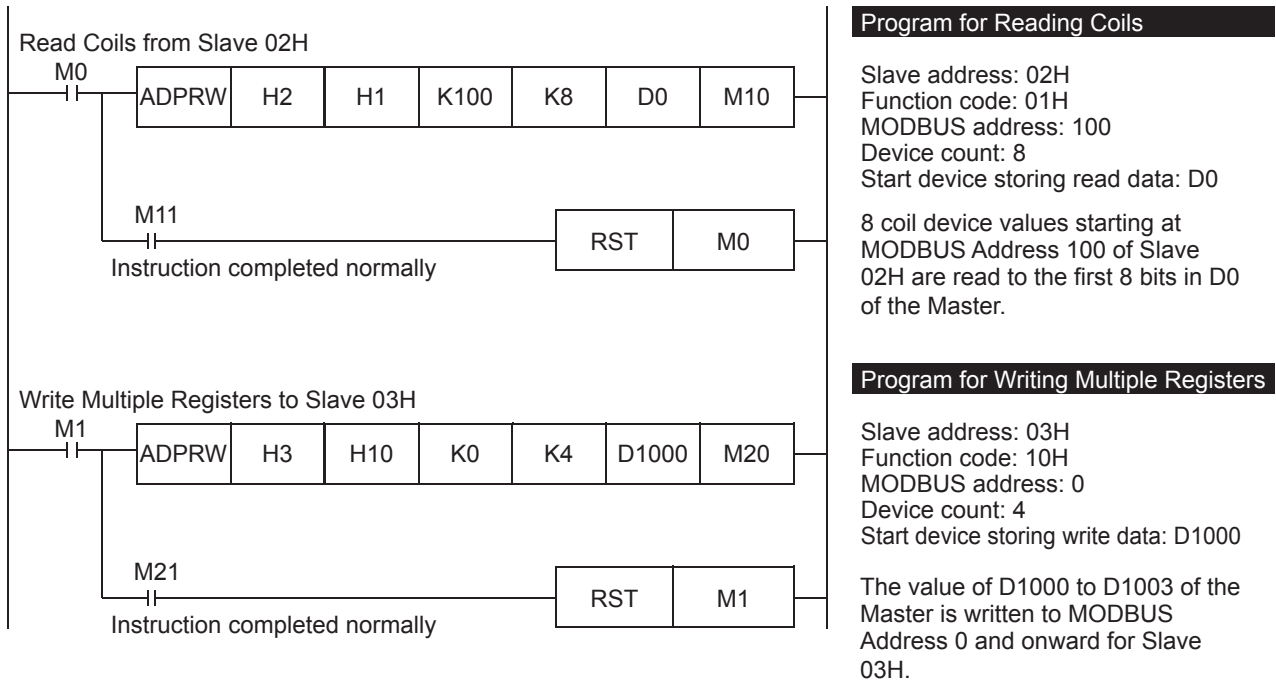

8.2 Cautions on Program Creation

- Make sure the driving contact of the ADPRW instruction does not turn off until the instruction has been completed.
- When driving multiple ADPRW instructions at the same time, the next ADPRW instruction in the program is executed after the current instruction has been completed. (only one instruction will be executed at a time)
- When using the Read coils function or Read inputs function in the Master with a word device (i.e. D, or R) as the destination device, only the number of bits assigned in the device count of the ADPRW instruction will be overwritten. The remaining bits of the word device will not be affected.

APPENDIX

Appendix 1 Troubleshooting

Checking the communication status based on LED indication

Check the status of the "RD" and "SD" indicator LEDs provided.

LED status		Operation status
RD	SD	
Lit	Lit	Data is being sent and received.
Lit	Unlit	Data is received, but is not sent.
Unlit	Lit	Data is sent, but is not received.
Unlit	Unlit	Data is neither sent nor received.

While MODBUS serial communication is functioning normally, both LEDs are lit.

If they are not lit, check the wiring, communication settings, and error statuses of the master and slave stations.

Checking the installation and wiring

■Mounting status

Verify that the communication equipment is securely connected with the CPU module, the expansion board or the expansion adapter. If the communication equipment is not securely connected, communication will not function correctly.

For the mounting procedure, refer to  the respective communication equipment manual.

■Wiring

Verify that all communication equipment is correctly wired. If the wiring is incorrect, communication will not function correctly.

For the wiring check method, refer to  Page 20 WIRING.

Checking parameters

■Communication setting of parameters

Verify that the communication setting parameters are suitable for use. If the communication settings are not suitable for use, communication will not function correctly. After changing any parameters, make sure to turn off the CPU module power, and then the power on again, or reset.

For the MODBUS communication settings, refer to  Page 25 COMMUNICATION SETTING.

Appendix 2 Error code

Serial communication error

■Error flags

If a communication error occurs in the serial communication, the serial communication error flag turns ON. Verify that the device specified in the table below is ON.

FX5 dedicated				FX3 compatible		Name	Description
CH1	CH2	CH3	CH4	CH1	CH2		
SM8500	SM8510	SM8520	SM8530	SM8063	SM8438	Serial communication error	Turns ON when an error occurs in serial communication.
—				SM8402	SM8422	MODBUS communication error	Turns ON when an error occurs in MODBUS communication.
—				SM8403	SM8423	MODBUS communication error (latched)	Turns on once an error occurs during MODBUS serial communication.

■Error codes

When the serial communication error turns ON, the error code and error detail will be stored in the relevant device.

FX5 dedicated				FX3 compatible		Name	Description
CH1	CH2	CH3	CH4	CH1	CH2		
SD8500	SD8510	SD8520	SD8530	SD8402 SD8063	SD8422 SD8438	Serial communication error code	When a serial communication error occurs, the error code is stored.
SD8501	SD8511	SD8521	SD8531	SD8403	SD8423	Serial communication error detail	When a serial communication error occurs, the error detail is stored.

The error codes (hexadecimal) and error details stored in devices are shown as follows.

Error code	Error details	Error name and Description	Error station
7001H	—	When used by the communication other than MODBUS communication	Slave
7010H	—	Parity, overrun (rx register) or framing error	Master/Slave
7302H	SD number where an error occurred is stored	Invalid MODBUS communication parameter setup (Invalid SD setting)	Master/Slave
7304H	—	CRC error	Master/Slave
7305H	—	Bus character overrun The received data amount is 256 bytes or more	Master/Slave
7306H	—	Data length mismatch The number of bytes received does not match with the specified number of bytes	Master/Slave
7307H	—	Unsupported function code error	Slave
7308H	—	Invalid device address	Slave
7309H	—	Slave response timeout A slave does not respond within the time set in the time-out time setting of the communication parameter	Master
730AH	The following "response message formats" are set. Exception function code: High-order byte Exception code: Low-order byte ( Page 44 When the processing is completed in error at the slave)	Exception response error Slave answers by exception response	Master
730BH	The following "response message formats" are set. Request station number: High-order byte Response station number: Low-order byte	Slave node address mismatch The slave node address of the response does not match the slave node address of the request	Master
730CH	The following "response message formats" are set. Request function code: High-order byte Response function code: Low-order byte	Function code mismatch The function code of the response does not match the function code of the request	Master
730DH	Response function code is stored.	Illegal broadcast command The read command is a broadcast command.	Slave
730EH	—	Illegal data value in request A value outside the valid range is included in a request message	Slave

■When the processing is completed in error at the slave

When a master receives an exception response from a slave, the following "response message formats" are set.

b15	to	b8 b7	to	b0
Exception function code (high-order byte)		Exception code (low-order byte)		

The following table outlines the exception function codes (high-order byte).

Exception function code	Function name	Details
81H	Read coils	Completed with an error by read binary (R/W) devices
82H	Read discrete inputs	Completed with an error by read binary (RO) devices
83H	Read holding registers	Completed with an error by read 16 bit (R/W) register
84H	Read input registers	Completed with an error by read 16 bit (RO) register
85H	Write single coil	Completed with an error by write single binary device
86H	Write single register	Completed with an error by write single 16 bit register device
8FH	Write multiple coils	Completed with an error by write multiple binary (R/W) devices
90H	Write multiple registers	Completed with an error by write multiple 16 bit (R/W) registers

The following table outlines the exception codes (low-order byte).

Exception code	Exception code name	Details
01H	Illegal function code	Unsupported function code was received
02H	Illegal device address	MODBUS address to which device is not allocated was accessed
03H	Illegal data value	An error occurred in the data area of the request message
04H	Failure during processing	An unrecoverable error occurred and processing was suspended while the slave was processing the request

Operation error

■Error flags

The operation error flag turns ON when an operation error occurs in the ADPRW instruction.

Verify that the device specified in the table below is ON.

FX5 dedicated				Name	Description
CH1	CH2	CH3	CH4		
SM0				Latest self-diagnostic error (Including the annunciator ON)	Turns ON when an operation error occurs.
SM1				Latest self-diagnostic error (Not including the annunciator ON)	
SM56, SM8067				Operation error	

■Error codes

When the operation error flag turns ON, the error code (hexadecimal) is stored in the operation error code (SD0/SD8067).

The error codes stored in the device are shown as follows.

Error code	Description	Details	Error station
1810H	Channel double use	Channel used by the instruction is used by another instruction.	Master/Slave
3600H	Invalid parameter setup	The instruction is used in Slave mode.	Slave
2822H	A device was specified that cannot be specified with the instruction.	Wrong operand set for the instruction.	Master
3405H	Data was entered outside of the range that can be specified.	The operand device number range or data value set for the instruction is out of range.	Master
2820H	A device or label was beyond the range that can be specified with the instruction.	The operand corresponding device set for the instruction is out of range.	Master

Appendix 3 The frame specifications of RTU mode

Procedure for generating of CRC

The error check in the RTU mode is conducted by CRC (Cyclic Redundancy Check).

A procedure for generating a CRC is:

- 1.** Load the register whose 16 bits are all "1". Call this the CRC register.
- 2.** Exclusive OR the first 8 bit byte of the message with the low-order byte of the 16 bit CRC register, putting the result in the CRC register.
- 3.** Shift the CRC register one bit to the right (toward the Least Significant Bit), zero-filling the MSB (Most Significant bit).
- 4.** Check the carry flag.
 - (If the carry flag was 0): Repeat Step 3 (another shift).
 - (If the carry flag was 1): Exclusive OR the CRC register with the value A001H (1010 0000 0000 0001).
- 5.** Repeat Steps 3 and 4 until 8 shifts have been executed. When this is done, a complete 8 bit byte will have been processed.
- 6.** Repeat Steps 2 through 5 for the next 8 bit byte of the message. Continue doing this until all bytes have been processed.
- 7.** The final content of the CRC register is the CRC value.
- 8.** When the CRC is placed in the message, the upper 8 bits is put in after the lower 8 bits.

The following is a calculation example in the case where function code 05H is sent to station No. (address field) 2.

CRC error check procedure	16-bit register				Carry Flag
(Load the register whose 16 bits are all "1")	1111	1111	1111	1111	
02H (Station No.)	0000	0000	0000	0010	
Exclusive OR (XOR)	1111	1111	1111	1101	
Shift 1	0111	1111	1111	1110	1
Generator value	1010	0000	0000	0001	
Exclusive OR (XOR)	1101	1111	1111	1111	
Shift 2	0110	1111	1111	1111	1
Generator value	1010	0000	0000	0001	
Exclusive OR (XOR)	1100	1111	1111	1110	
Shift 3	0110	0111	1111	1111	0
Shift 4	0011	0011	1111	1111	1
Generator value	1010	0000	0000	0001	
Exclusive OR (XOR)	1001	0011	1111	1110	
Shift 5	0100	1001	1111	1111	0
Shift 6	0010	0100	1111	1111	1
Generator value	1010	0000	0000	0001	
Exclusive OR (XOR)	1000	0100	1111	1110	
Shift 7	0100	0010	0111	1111	0
Shift 8	0010	0001	0011	1111	1
Generator value	1010	0000	0000	0001	
Exclusive OR (XOR)	1000	0001	0011	1110	
05H (Function code)	0000	0000	0000	0101	
Exclusive OR (XOR)	1000	0001	0011	1011	
Shift 1	0100	0000	1001	1101	1
Generator value	1010	0000	0000	0001	
Exclusive OR (XOR)	1110	0000	1001	1100	
Shift 2	0111	0000	0100	1110	0
Shift 3	0011	1000	0010	0111	0
Shift 4	0001	1100	0001	0011	1
Generator value	1010	0000	0000	0001	
Exclusive OR (XOR)	1011	1100	0001	0010	
Shift 5	0101	1110	0000	1001	0
Shift 6	0010	1111	0000	0100	1
Generator value	1010	0000	0000	0001	
Exclusive OR (XOR)	1000	1111	0000	0101	
Shift 7	0100	0111	1000	0010	1
Generator value	1010	0000	0000	0001	
Exclusive OR (XOR)	1110	0111	1000	0011	
Shift 8	0111	0011	1100	0001	1
CRC value	73H		C1H		

Address field	Function code	CRC (Error check)	
(02H)	(05H)	(C1H)	(73H)

MODBUS protocol data unit formats

This section explains MODBUS protocol data unit formats of the MODBUS standard functions.

The MODBUS protocol data unit contains request messages sent from the master to a slave and response messages sent from the slave to the master.

How to see the request/response message formats

Request/Response message format diagram

The following shows how to see the request/response message format diagrams provided in [Page 48 Read coils to](#) [Page 54 Write multiple registers](#).

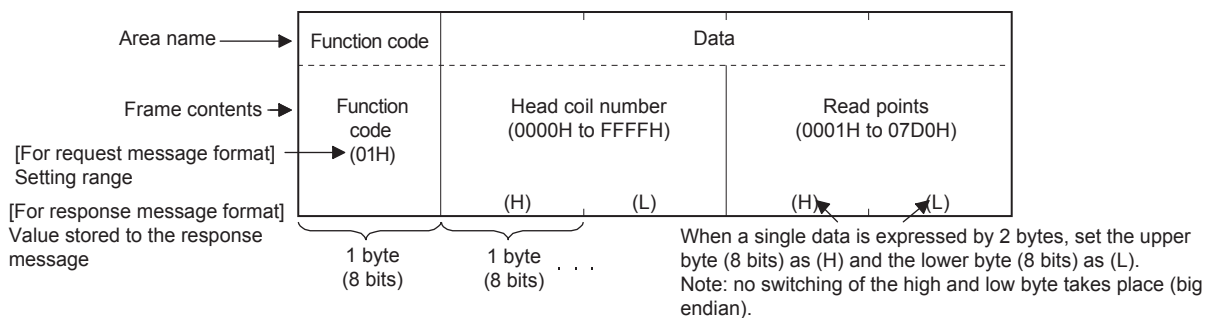

Response message format

The response message formats issued from the slave to the master differs depending on whether the slave has normally completed or failed to handle the requested processing (read/write, diagnosis etc.).

The formats for normal and error completions are shown in [Page 48 Read coils to](#) [Page 54 Write multiple registers](#).

Precautions

When the slave receives a broadcast request message

Although the processing requested by the request message is performed, no response message is sent to the master.

When the processing is completed with error at the slave

When the processing (read/write, diagnosis etc.) requested by the request message is completed with error, an exception code is sent to the master.

Refer to "Response message formats (when completed with an error)" in [Page 48 Read coils to](#) [Page 54 Write multiple registers](#).

Storage location of exception code and error code

Refer to [Page 33 Related Devices](#) for the storage location, confirmation methods, and other detailed contents.

Read coils

Reads the status (ON/OFF) of one or more coils.

Request message format (Master → Slave)

Function code	Data			
Function code (01H)	Head coil number (0000H to FFFFH)		Read points (0001H to 07D0H)	
	(H)	(L)	(H)	(L)

Response message format (Slave → Master)

(When completed normally)

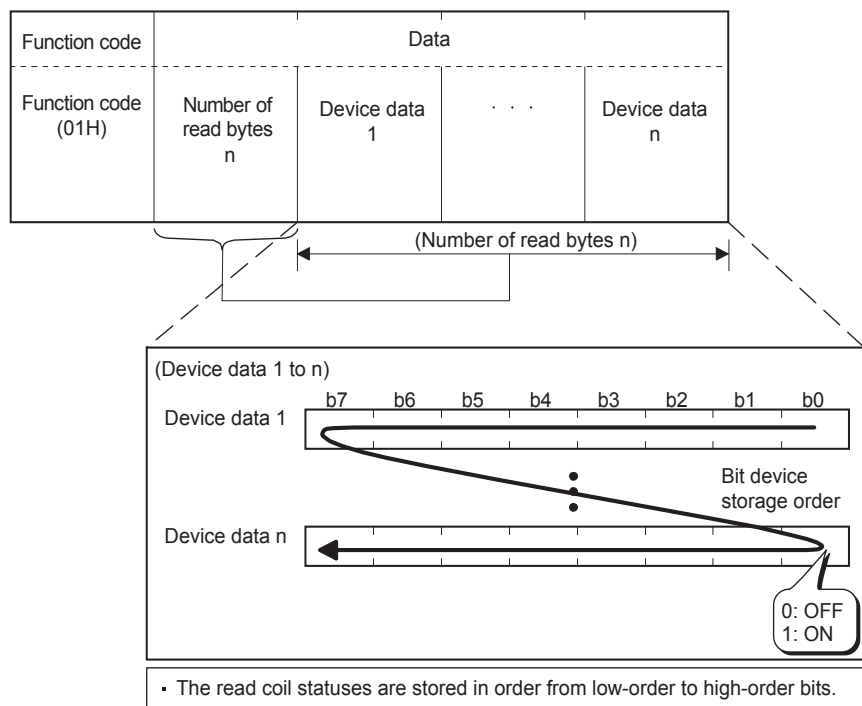

(When completed with an error)

Function code	Data
Function code (81H)	Exception code*1

*1 Exception and error codes are stored in special registers in the case of error completion. Refer to Page 33 Related Devices for the storage location, confirmation methods, and other detailed contents.

Read holding registers

Reads the values of one or more holding registers.

Request message format (Master → Slave)

Function code	Data			
Function code (03H)	Head holding register number (0000H to FFFFH)		Read points (0001H to 007DH)	
	(H)	(L)	(H)	(L)

Response message format (Slave → Master)

(When completed normally)

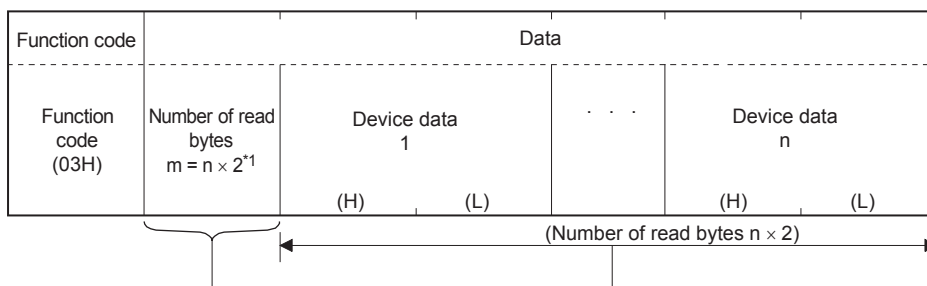

*1 For example, if $n = 4$, the number of bytes is calculated as $4 \times 2 = 8$ bytes.

(When completed with an error)

Function code	Data
Function code (83H)	Exception code ^{*2}

*2 Exception and error codes are stored in special registers in the case of error completion. Refer to Page 33 Related Devices for the storage location, confirmation methods, and other detailed contents.

Read input registers

Reads the values of one or more input registers.

Request message format (Master → Slave)

Function code	Data			
Function code (04H)	Head input register number (0000H to FFFFH)		Read points (0001H to 007DH)	
	(H)	(L)	(H)	(L)

Response message format (Slave → Master)

(When completed normally)

Function code	Data			
Function code (04H)	Number of read bytes $m = n \times 2^{*1}$	Device data 1		Device data n
		(H)	(L)	(H) (L)

(Number of read bytes $n \times 2$)

*1 For example, if $n = 4$, the number of bytes is calculated as $4 \times 2 = 8$ bytes.

(When completed with an error)

Function code	Data
Function code (84H)	Exception code ^{*2}

*2 Exception and error codes are stored in special registers in the case of error completion. Refer to Page 33 Related Devices for the storage location, confirmation methods, and other detailed contents.

Write single coil

Writes a value (ON/OFF) to one coil.

Request message format (Master → Slave)

Function code	Data			
Function code (05H)	Coil number (0000H to FFFFH)		ON/OFF specification (0000H: OFF FF00H: ON)	
	(H)	(L)	(H)	(L)

Response message format (Slave → Master)

(When completed normally)

The slave returns the request message received from the master without change.

(When completed with an error)

Function code	Data
Function code (85H)	Exception code*1

*1 Exception and error codes are stored in special registers in the case of error completion. Refer to  Page 33 Related Devices for the storage location, confirmation methods, and other detailed contents.

Write single register

Writes a value to one holding register.

Request message format (Master → Slave)

Function code	Data			
Function code (06H)	Holding register number (0000H to FFFFH)		Write data (0000H to FFFFH)	
	(H)	(L)	(H)	(L)

Response message format (Slave → Master)

(When completed normally)

The slave returns the request message received from the master without change.

(When completed with an error)

Function code	Data
Function code (86H)	Exception code*1

*1 Exception and error codes are stored in special registers in the case of error completion. Refer to  Page 33 Related Devices for the storage location, confirmation methods, and other detailed contents.

Write multiple coils

Writes values (ON/OFF) to multiple coils.

Request message format (Master → Slave)

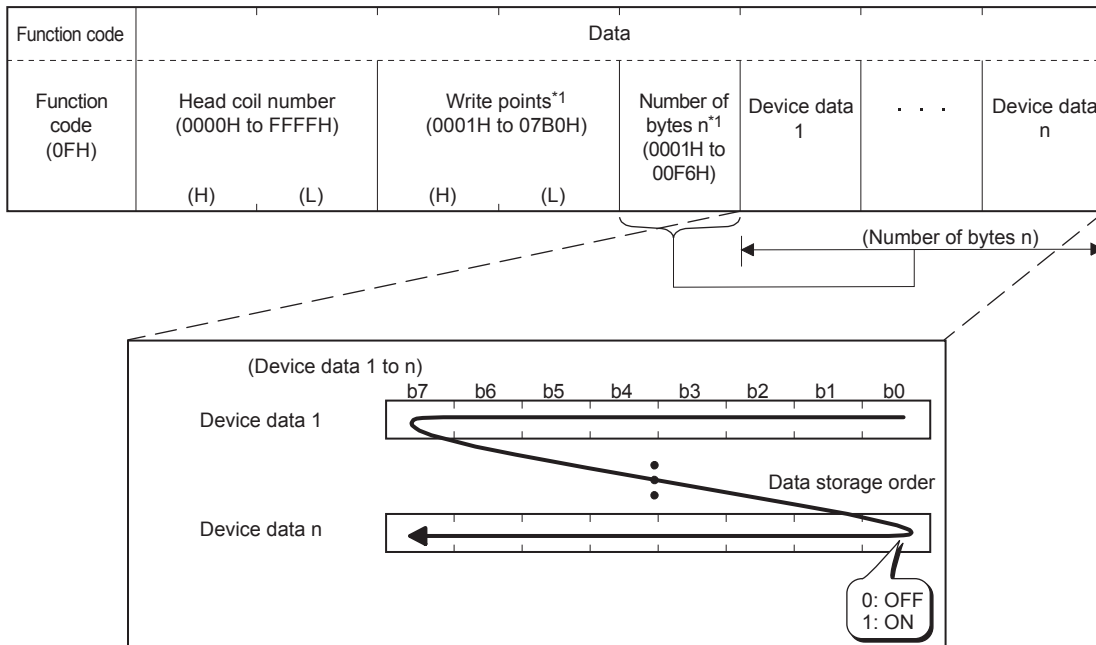

The values (ON/OFF) stored into the device data 1 to n are written to the coils in order from low-order to high-order bits of the device data.

*1 The number of the specified write points must be matched with the number of bits specified as the number of bytes. For example, when the write points are set to 16, set the number of bytes to 2 bytes (= 16 bits).

Response message format (Slave → Master)

(When completed normally)

Function code	Data			
Function code (0FH)	Head coil number (The same head coil number value as in the request message is stored.)		Write points (The same write points value as in the request message is stored.)	
	(H)	(L)	(H)	(L)

(When completed with an error)

Function code	Data
Function code (8FH)	Exception code* ¹

*1 Exception and error codes are stored in special registers in the case of error completion. Refer to Page 33 Related Devices for the storage location, confirmation methods, and other detailed contents.

Write multiple registers

Writes values to multiple holding registers.

Request message format (Master → Slave)

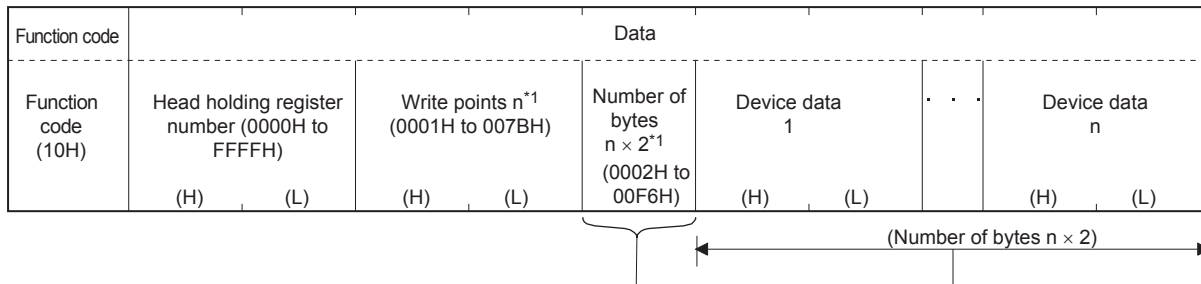

*1 The number of the specified write points must match the number of bytes.

Response message format (Slave → Master)

(When completed normally)

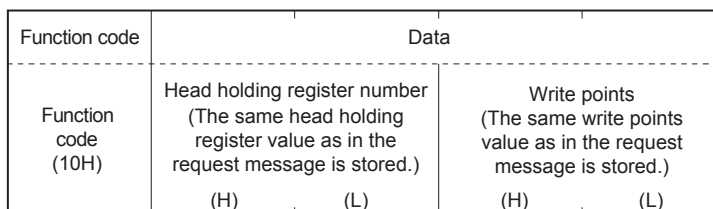

(When completed with an error)

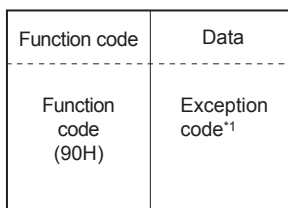

*1 Exception and error codes are stored in special registers in the case of error completion. Refer to [Page 33 Related Devices](#) for the storage location, confirmation methods, and other detailed contents.

Appendix 4 Initial values of MODBUS device allocation

Parameter initial value of MODBUS device allocation

The FX5 dedicated pattern and the FX3U compatible pattern are provided for the parameter initial values.

■FX5 dedicated pattern

MODBUS address <Bit device>	FX5 device	
	Coil (read/write)	Input (read only)
0000H to 03FFH	Y0 to 1023	X0 to 1023
0400H to 1FFFH	—	—
2000H to 3DFFH	M0 to 7679	—
3E00H to 4FFFH	—	—
5000H to 57FFH	SM0 to 2047	—
5800H to 75FFH	L0 to 7679	—
7600H to 77FFH	—	—
7800H to 78FFH	B0 to 255	—
7900H to 97FFH	—	—
9800H to 987FH	F0 to 127	—
9880H to 9FFFH	—	—
A000H to A0FFH	SB0 to 255	—
A100H to AFFFH	—	—
B000H to BFFFH	S0 to 4095	—
C000H to CFFFH	—	—
D000H to D1FFH	TC0 to 511	—
D200H to D7FFH	—	—
D800H to D9FFH	TS0 to 511	—
DA00H to DFFFH	—	—
E000H to E00FH	SC0 to 15	—
E010H to E7FFH	—	—
E800H to E80FH	SS0 to 15	—
E810H to EFFFH	—	—
F000H to F0FFH	CC0 to 255	—
F100H to F7FFH	—	—
F800H to F8FFH	CS0 to 255	—
F900H to FFFFH	—	—

MODBUS address <Word device>	FX5 device	
	Input register (read only)	Holding register (read/write)
0000H to 1F3FH	—	D0 to 7999
1F40H to 4FFFH	—	—
5000H to 770FH	—	SD0 to 9999
7710H to 77FFH	—	—
7800H to 79FFH	—	W0 to 512
7A00H to 9FFFH	—	—
A000H to A0FFH	—	SW0 to 512
A100H to CFFFH	—	—
D000H to D1FFH	—	TN0 to 511
D200H to DFFFH	—	—
E000H to E00FH	—	SN0 to 15
E010H to EFFFH	—	—
F000H to F0FFH	—	CN0 to 255
F100H to FFFFH	—	—

■FX3U compatible pattern

MODBUS address <Bit device>	FX5 device	
	Coil (read/write)	Input (read only)
0000H to 1DFFH	M0 to 7679	—
1E00H to 1FFFH	SM8000 to 8511	—
2000H to 2FFFH	S0 to 4095	—
3000H to 31FFH	TS0 to 511	—
3200H to 32FFH	CS0 to 255	—
3300H to 33FFH	Y0 to 377	—
3400H to 34FFH	—	X0 to 377
3500H to FFFFH	—	—

MODBUS address <Word device>	FX5 device	
	Input register (read only)	Holding register (read/write)
0000H to 1F3FH	—	D0 to 7999
1F40H to 213FH	—	SD8000 to 8511
2140H to A13FH	—	R0 to 32767
A140H to A33FH	—	TN0 to 511
A340H to A407H	—	CN0 to 199
A408H to A477H	—	LN0 to 55
A478H to A657H	—	M0 to 7679
A658H to A677H	—	SM8000 to 8511
A678H to A777H	—	S0 to 4095
A778H to A797H	—	TS0 to 511
A798H to A7A7H	—	CS0 to 255
A7A8H to A7B7H	—	Y0 to 377
A7B8H to A7BCH	X0 to 377	LS0 to 63
A7BDH to A7C7H		—
A7C8H to FFFFH	—	—

INDEX

A

Address field	18
Available devices	28

B

Broadcast delay	40
---------------------------	----

C

Communication execution status output device	32
Communication format setting value	38
Communication specifications	14
Current retry value	39

D

Data	18
During MODBUS communication	35

E

Error check.	18
----------------------	----

F

Frame mode.	19
Function code.	18
Function code and function parameters	31

H

Host station number	39
Host station number SD latch setting valid	37

I

Instruction execution complete	35
--	----

L

Latch setting	29
Link time	15
List of related devices	33
List of supported MODBUS standard functions.	19

M

Master function	14,30
Master processing time	16
Message to message delay	40
MODBUS communication error.	35
MODBUS communication error (latched).	36
MODBUS protocol data unit formats	47

N

Number of connectable units	14
---------------------------------------	----

O

Operation error.	44
Operation mode display.	39

P

Parameter initial value.	55
Procedure for operation.	11

R

Read coils	48
Read holding registers	50
Read input registers	51
Read inputs	49
Retry	36
RS-232C	20
RS-485	20

S

Serial communication error	36,43
Serial communication error code	37
Serial communication error details	38
Slave function	33
Slave processing time	16
Slave response timeout.	40
SM/SD for FX3 Series compatible	29
System configuration.	12

T

Termination resistor selector switch	22
Termination resistor setting	22
Timeout	37
Timeout retry count.	40

W

Write multiple coils	53
Write multiple registers	54
Write single coil	52
Write single register	52

REVISIONS

Revision date	Revision	Description
October 2014	A	First Edition
January 2015	B	■Added new model FX5UC CPU
April 2015	C	A part of the cover design is changed.

This manual confers no industrial property rights or any rights of any other kind, nor does it confer any patent licenses. Mitsubishi Electric Corporation cannot be held responsible for any problems involving industrial property rights which may occur as a result of using the contents noted in this manual.

© 2014 MITSUBISHI ELECTRIC CORPORATION

WARRANTY

Please confirm the following product warranty details before using this product.

1. Gratis Warranty Term and Gratis Warranty Range

If any faults or defects (hereinafter "Failure") found to be the responsibility of Mitsubishi occurs during use of the product within the gratis warranty term, the product shall be repaired at no cost via the sales representative or Mitsubishi Service Company. However, if repairs are required onsite at domestic or overseas location, expenses to send an engineer will be solely at the customer's discretion. Mitsubishi shall not be held responsible for any re-commissioning, maintenance, or testing on-site that involves replacement of the failed module.

[Gratis Warranty Term]

The gratis warranty term of the product shall be for one year after the date of purchase or delivery to a designated place. Note that after manufacture and shipment from Mitsubishi, the maximum distribution period shall be six (6) months, and the longest gratis warranty term after manufacturing shall be eighteen (18) months. The gratis warranty term of repair parts shall not exceed the gratis warranty term before repairs.

[Gratis Warranty Range]

- 1) The range shall be limited to normal use within the usage state, usage methods and usage environment, etc., which follow the conditions and precautions, etc., given in the instruction manual, user's manual and caution labels on the product.
- 2) Even within the gratis warranty term, repairs shall be charged for in the following cases.
 - a) Failure occurring from inappropriate storage or handling, carelessness or negligence by the user. Failure caused by the user's hardware or software design.
 - b) Failure caused by unapproved modifications, etc., to the product by the user.
 - c) When the Mitsubishi product is assembled into a user's device, Failure that could have been avoided if functions or structures, judged as necessary in the legal safety measures the user's device is subject to or as necessary by industry standards, had been provided.
 - d) Failure that could have been avoided if consumable parts (battery, backlight, fuse, etc.) designated in the instruction manual had been correctly serviced or replaced.
 - e) Relay failure or output contact failure caused by usage beyond the specified life of contact (cycles).
 - f) Failure caused by external irresistible forces such as fires or abnormal voltages, and failure caused by force majeure such as earthquakes, lightning, wind and water damage.
 - g) Failure caused by reasons unpredictable by scientific technology standards at time of shipment from Mitsubishi.
 - h) Any other failure found not to be the responsibility of Mitsubishi or that admitted not to be so by the user.

2. Onerous repair term after discontinuation of production

- 1) Mitsubishi shall accept onerous product repairs for seven (7) years after production of the product is discontinued.
Discontinuation of production shall be notified with Mitsubishi Technical Bulletins, etc.
- 2) Product supply (including repair parts) is not available after production is discontinued.

3. Overseas service

Overseas, repairs shall be accepted by Mitsubishi's local overseas FA Center. Note that the repair conditions at each FA Center may differ.

4. Exclusion of loss in opportunity and secondary loss from warranty liability

Regardless of the gratis warranty term, Mitsubishi shall not be liable for compensation of damages caused by any cause found not to be the responsibility of Mitsubishi, loss in opportunity, lost profits incurred to the user or third person by failure of Mitsubishi products, special damages and secondary damages whether foreseeable or not, compensation for accidents, and compensation for damages to products other than Mitsubishi products, replacement by the user, maintenance of on-site equipment, start-up test run and other tasks.

5. Changes in product specifications

The specifications given in the catalogs, manuals or technical documents are subject to change without prior notice.

6. Product application

- 1) In using the Mitsubishi MELSEC programmable controller, the usage conditions shall be that the application will not lead to a major accident even if any problem or fault should occur in the programmable controller device, and that backup and fail-safe functions are systematically provided outside of the device for any problem or fault.
- 2) The Mitsubishi programmable controller has been designed and manufactured for applications in general industries, etc. Thus, applications in which the public could be affected such as in nuclear power plants and other power plants operated by respective power companies, and applications in which a special quality assurance system is required, such as for railway companies or public service purposes shall be excluded from the programmable controller applications.
In addition, applications in which human life or property that could be greatly affected, such as in aircraft, medical applications, incineration and fuel devices, manned transportation, equipment for recreation and amusement, and safety devices, shall also be excluded from the programmable controller range of applications.
However, in certain cases, some applications may be possible, providing the user consults their local Mitsubishi representative outlining the special requirements of the project, and providing that all parties concerned agree to the special circumstances, solely at the user's discretion.

TRADEMARKS

Microsoft® and Windows® are either registered trademarks or trademarks of Microsoft Corporation in the United States and/or other countries.

Ethernet is a trademark of Xerox Corporation.

MODBUS® is a registered trademark of Schneider Electric SA.

The company name and the product name to be described in this manual are the registered trademarks or trademarks of each company.

Manual number: JY997D56101C

Model: FX5-U-MB-E

Model code: 09R542

When exported from Japan, this manual does not require application to the Ministry of Economy, Trade and Industry for service transaction permission.

MITSUBISHI ELECTRIC CORPORATION

HEAD OFFICE: TOKYO BUILDING, 2-7-3 MARUNOUCHI, CHIYODA-KU, TOKYO 100-8310, JAPAN

Specifications are subject to change without notice.