

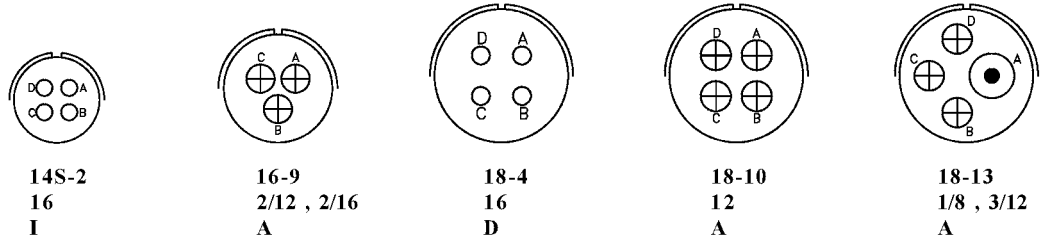

Contact arrangement

4 CONTACTS

ARRANGEMENT
CONTACT SIZE
SERVICE RATING



ARRANGEMENT
CONTACT SIZE
SERVICE RATING

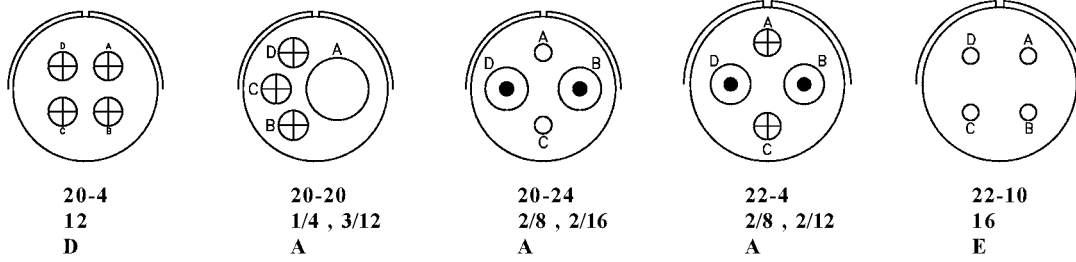

ARRANGEMENT
CONTACT SIZE
SERVICE RATING

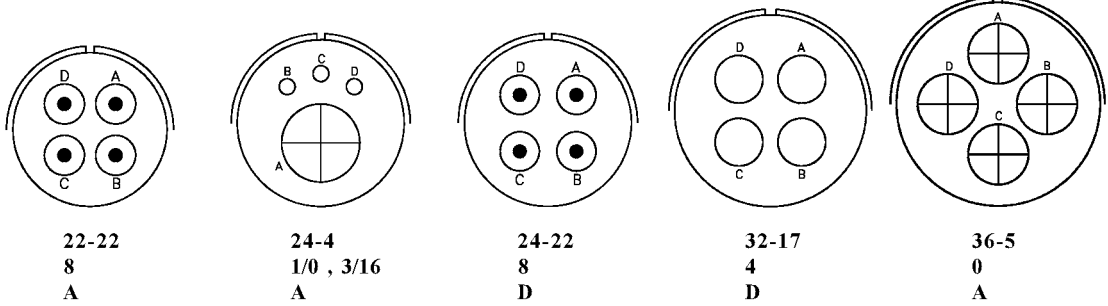

ARRANGEMENT
CONTACT SIZE
SERVICE RATING

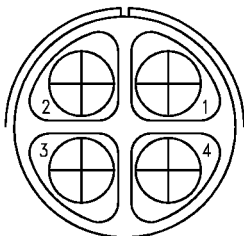

5 CONTACTS

ARRANGEMENT
CONTACT SIZE
SERVICE RATING

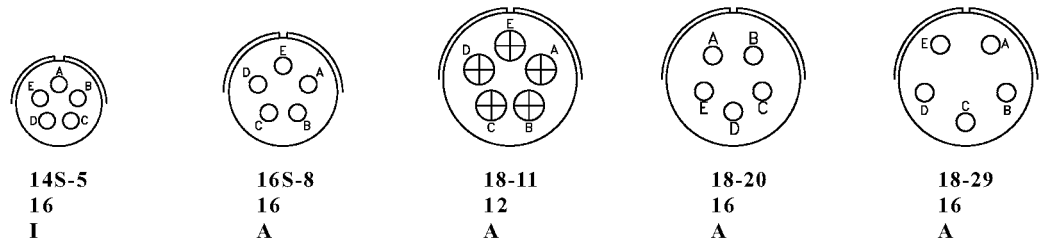

CONTACT LEGEND

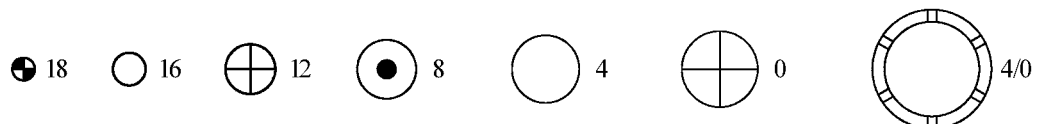



**CM1 3102 A / CM1 3102 E / CM1 3102 R
CM1 4102 A / CM1 4102 E / CM1 4102 R**

Box mounting receptacle

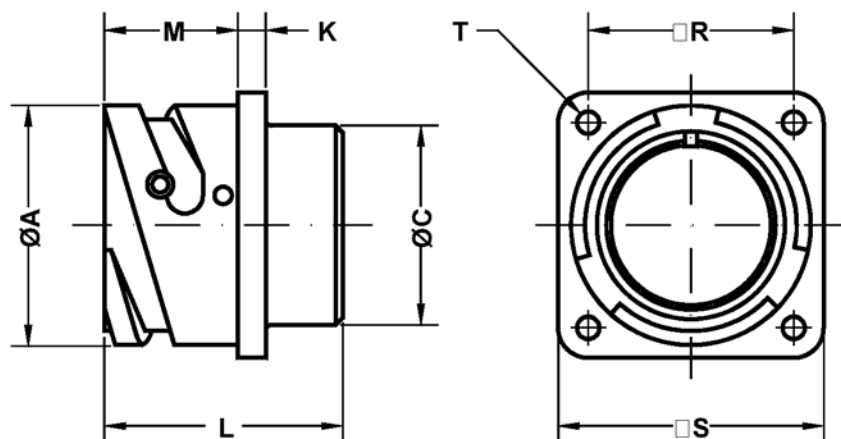

Shell size	ØA +0 -0.1	ØC Max.	K ±0.2	L Max.	M +0.2 -0	R ±0.1	S +0.2	ØT +0.1 -0
10 SL	18.2	16.2	2.8	24.7	14.3	18.25	25.4	3.2
14 S	24.5	19.2	3.3	24.7	14.5	23.00	30.4	3.2
16 S	27.2	22.4	3.3	24.7	14.5	24.60	32.5	3.2
16	27.2	22.4	3.3	33.8	19.1	24.60	32.5	3.2
18	30.7	25.6	4.0	34.5	19.1	27.00	35.0	3.2
20	34.0	29.0	4.0	34.5	19.1	29.40	38.0	3.2
22	37.3	32.2	4.0	34.5	19.6	31.75	41.0	3.2
24	40.9	35.3	4.0	35.7	20.6	34.90	44.5	3.7
28	46.7	41.4	4.0	35.7	20.7	39.70	50.9	3.7
32	53.4	47.8	4.0	37.3	22.3	44.45	57.0	4.3
36	59.6	54.1	4.0	37.3	22.3	49.20	63.5	4.3
40	65.5	59.0	4.0	37.3	22.3	55.55	69.9	4.3

Box mounting square flange receptacle.
Class A: for general use,
Class E, R: for environmental sealing.

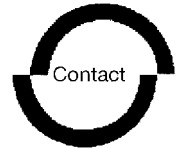

HOW TO ORDER

<u>FR</u>	<u>CM1</u>	<u>31</u>	<u>06</u>	<u>A</u>	<u>20-27</u>	<u>P</u>	<u>X</u>	<u>(...)</u>
<i>1</i>	<i>2</i>	<i>3</i>	<i>4</i>	<i>5</i>	<i>6</i>	<i>7</i>	<i>8</i>	<i>9</i>

- 1* Omitted : Standard
FR : Fire Resistant rubber
- 2* CM1 : Bayonet coupling
*CM4 : Bayonet coupling without stainless steel wear pins
- 3* 31 : Solder contacts
41 : Crimp contacts
- 4* Style : 00 - 01 - 02 - 03 - 030 - 05 - 06 - 07 - 070 - 078 - 08 - 26
- 5* Class : A - F - G - GR - RS - SP - Y
- 6* Contact arrangement
- 7* P : Pin contacts
S : Socket contacts
P/S : Contacts for 02PP connectors
- 8* W - X - Y - Z : Alternate positions of the inserts
- 9* Modifications (see the next page)

* Only for receptacles

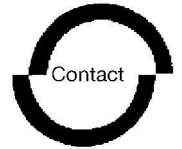

Technical characteristics

Metal parts

Aluminium alloy with Cadmium free surface coatings with an olive drab passivation .

Contacts

The following contact types are available : copper alloy with silver plating (Std) or gold plating (available on request).

Insulating parts

High insulation synthetic rubber resistant to oils and high range of temperatures (-55°C to +125°C) in accordance with MIL-R-3065. Are also available in fire resistant and halogen free materials.

Contacts

Contact size	Rated current at 20°C	Max. Contact resist.	Wire size
18	7.5 A	12.0 mΩ	20+26 AWG
16	22 A	6.0 mΩ	16+22 AWG
12	41 A	3.0 mΩ	12-14 AWG
8	73 A	1.0 mΩ	8-10 AWG
4	135 A	0.5 mΩ	4-6 AWG
0	245 A	0.3 mΩ	0+2 AWG
4/0	350 A	0.2 mΩ	4/0 AWG

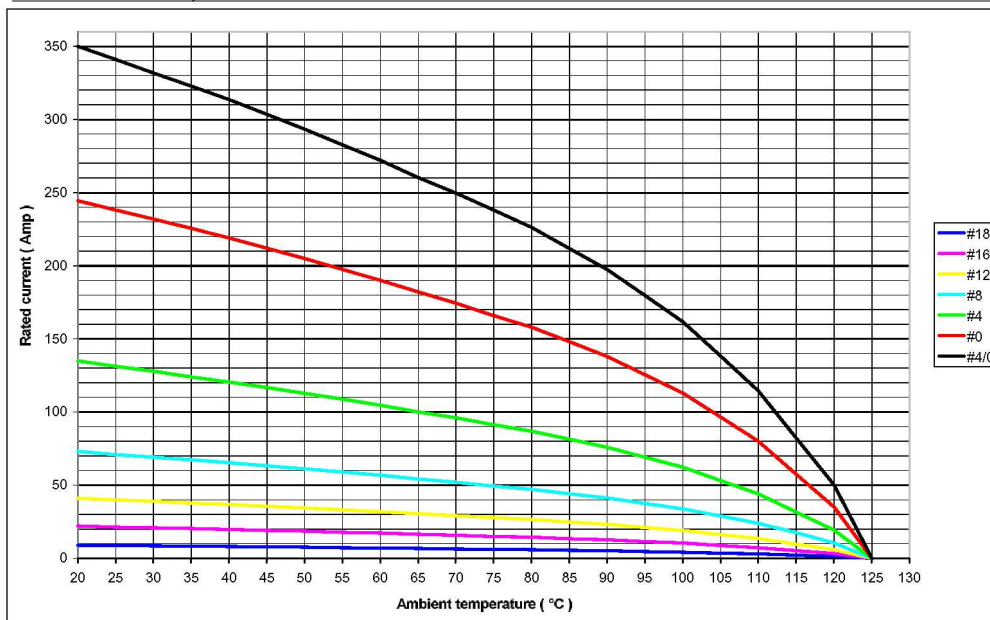

Service rating (Min insulating resistance : $\geq 5 \times 10^3 \text{ M}\Omega$)

Class	Operating voltage Vdc	Operating voltage VacRMS	Test voltage Vac RMS
INST.	250 V	200 V	1000 V
A	700 V	500 V	2000 V
D	1250 V	900 V	2800 V
E	1750 V	1250 V	3500 V
B	2450 V	1750 V	4500 V
C	4200 V	3000 V	7000 V

Socket contacts

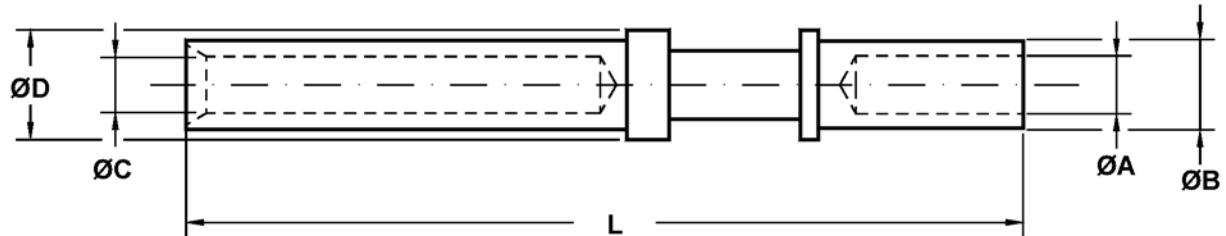

Contact P/N	Size	mm ²	AWG	A +0.1 -0	B +0 -0.1	C +0.05 -0	D +0 -0.1	L ±0.1
CM - 40588	18	0.15 / 0.6	26 / 20	1.30	1.93	1.48	2.2	34.40
CM - 40552	16S	1 / 1.5	18 / 16	1.70	2.60	1.65	3.2	26.65
CM - 40552 - 12	16S	0.6	20	1.20	2.60	1.65	3.2	26.65
CM - 40552 - 13	16S	0.15 / 0.6	26 / 20	1.30	1.93	1.65	3.2	26.65
CM - 40552 - 15	16S	1	18	1.50	2.60	1.65	3.2	26.65
CM - 40552 - 20	16S	2	14	2.00	2.90	1.65	3.2	26.65
CM - 40552 - 26	16S	3	12	2.50	3.80	1.65	3.2	26.65
CM - 40556	16	1 / 1.5	18 / 16	1.70	2.60	1.65	3.2	36.50
CM - 40556 - 08	16	0.15 / 0.2	26 / 24	0.85	1.55	1.65	3.2	36.50
CM - 40556 - 12	16	0.6	20	1.20	2.60	1.65	3.2	36.50
CM - 40556 - 13	16	0.15 / 0.6	26 / 20	1.30	1.93	1.65	3.2	36.50
CM - 40556 - 15	16	1	18	1.50	2.60	1.65	3.2	36.50
CM - 40556 - 20	16	2	14	2.00	2.90	1.65	3.2	36.50
CM - 40556 - 26	16	3	12	2.50	3.80	1.65	3.2	36.50
CM - 40556 - 32	16		32 / 28	0.45	1.95	1.65	3.2	36.50
CM - 40560	12	3	12	2.50	3.90	2.48	4.8	37.65
CM - 40560 - 12	12	0.6	20	1.20	2.60	2.48	4.8	37.65
CM - 40560 - 15	12	1	18	1.50	3.40	2.48	4.8	37.65
CM - 40560 - 20	12	1 / 2	18 / 14	2.00	3.80	2.48	4.8	37.65
CM - 40560 - 22	12	2.5		2.20	3.80	2.48	4.8	37.65
CM - 40560 - 30	12	4		3.00	4.80	2.48	4.8	37.65
CM - 40560 - 30M	12	4		3.30	4.20	2.48	4.8	37.65
CM - 40560 - 38	12	6		3.60	4.80	2.48	4.8	37.65
CM - 40793	8	6 / 8	8	4.50	6.90	3.73	7.8	42.00
CM - 40793 - 50	8	10		5.00	6.90	3.73	7.8	42.00
CM - 113474 - 4S	4	22	4	7.15	9.53	5.84	11.0	42.00
CM - 113474 - 1S	0	50 / 60	0	11.50	14.30	9.20	15.1	45.00
CM - 113474 - 0S	4/0	107	4/0	16.50	20.00	12.70	20.0	65.50

Please consult our sales department for other contacts or crimp tooling details .