

V107C021A-940

BIDOS® P2835 C

VCSEL pulsed laser in small footprint ceramic

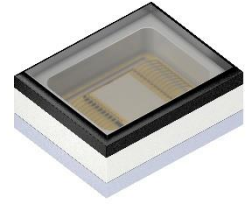

Applications

- Virtual Reality
- 3D Sensing
- Industrial Automation
- Access Control (IRIS/Vein Scan, Face Recognition)
- Augmented Reality, Mixed Reality
- Flash & Autofocus
- Gesture Recognition

Features:

- Package: SMD ceramic package with glass diffuser window
- Chip Technology: GaAs VCSEL power array
- IR Laser Wavelength: 940 nm
- Optical Power Class: 4 W pulsed
- Radiation Profile: 60°x45° (Rectangular emission profile)
- ESD: 8 kV acc. to ANSI/ESDA/JEDEC JS-001 (HBM, Class 3B)

Ordering Information

Type	Operational Mode: $I_F = 5A, T_S = 25^\circ C$ $t_p = 100\mu S, DC = 1\%$	Ordering Code
V107C021A-940	4W	Q65113A0123

Depending on the mode of operation, these devices emit highly concentrated visible and non-visible light which can be hazardous to the human eye. Products which incorporate these devices must follow the safety precautions given in the “Notes” section.

Maximum Ratings

$T_a = 25^\circ\text{C}$

Parameter	Symbol		Values
Operation/Solder temperature	T_s	min.	-40°C
$t_p = 100\ \mu\text{s}$; DC = 1 %		max.	110°C
Storage temperature	T_{stg}	min.	-40°C
		max.	110°C
Forward current	I_f	max.	16 A
Pulsed operation; $T_p = 100\ \mu\text{s}$; DC = 1 %; $T_s = 25^\circ\text{C}$			
Forward current	I_f	max.	6 A
Direct current operation; DC = 100%; $T_s = 25^\circ\text{C}$			
Reverse Voltage	Not designed for reverse operation		
Reflow soldering temperature	T_{Ref}	max.	260°C
ESD withstand voltage	V_{ESD}	max.	8 kV
acc. to ANSI/ESDA/JEDEC JS-001 (HBM, Class 3B)			

Note: Stresses beyond those listed under Absolute Maximum Ratings may cause permanent damage to the device.

Characteristics

$T_a = 25^\circ\text{C}$, $I_F = 5\text{ A}$; $t_p = 100\mu\text{s}$; DC = 1%

Parameter	Symbol		Values
Forward voltage	V_F	typ.	2.15 V
Output power	Φ	typ.	4.0 W
Threshold current	I_{th}	typ.	0.82 A
Slope efficiency	SE	typ.	1.0 W / A
Power conversion efficiency	η	typ.	37 %
Peak wavelength	λ_{peak}	min.	930 nm
		typ.	940 nm
		max.	950 nm
Spectral bandwidth at FWHM (50% of Φ_{max})	λ_{FWHM}	typ.	2 nm
Temperature coefficient of wavelength	TC_λ	typ.	0.06 nm / K
Field of view at FWHM (HFOV)	$\theta_{ }$	typ.	60 °
Field of view at FWHM (VFOV)	θ_{\perp}	typ.	45 °
Thermal resistance junction/solder point	$R_{th, JS}$	typ.	15.9 K / W

Relative Spectral Emission ¹⁾

$$\Phi_{rel} = f(\lambda); I_F = 4 \text{ A}; T_S = 25 \text{ }^\circ\text{C}$$

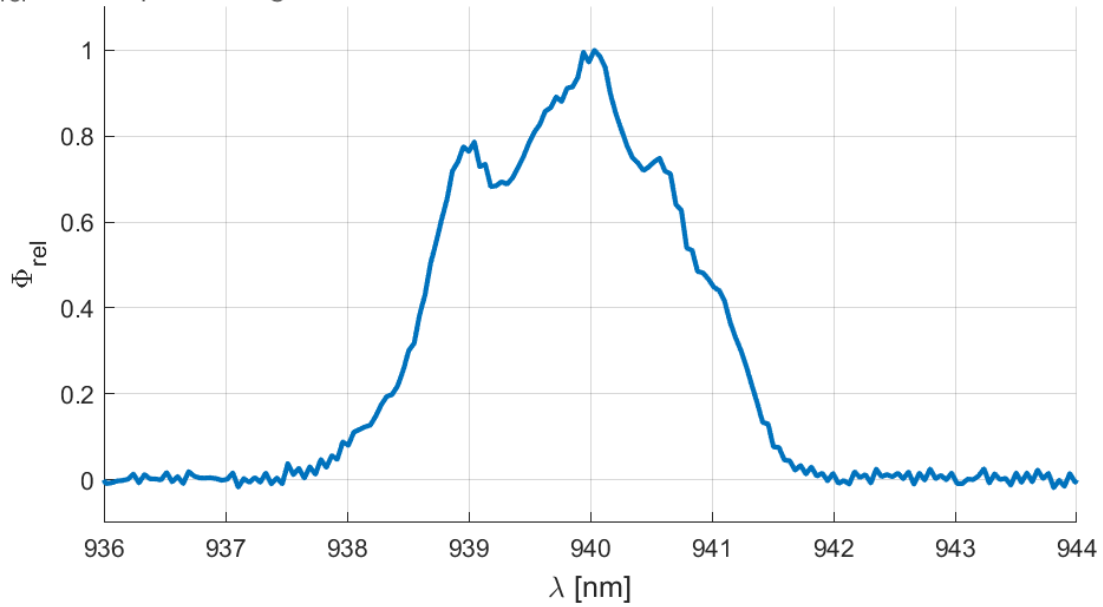

Radiation Characteristics ¹⁾

$$\Phi_{rel} = f(\phi); T_S = 20 \text{ }^\circ\text{C}$$

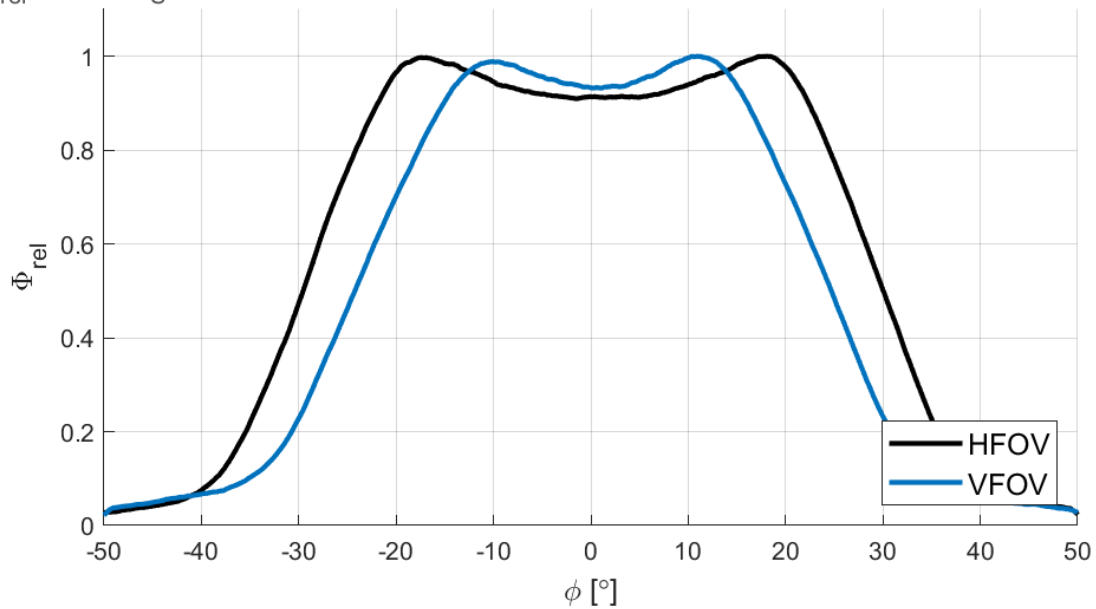

Forward Voltage ^{1) 2)}

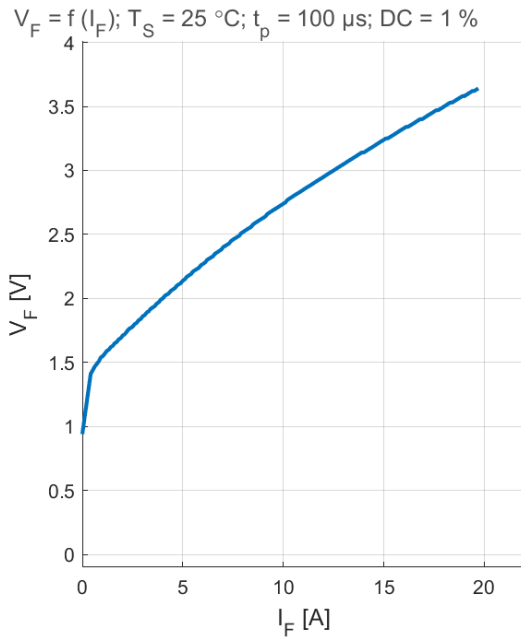

Optical Output Power ^{1) 2)}

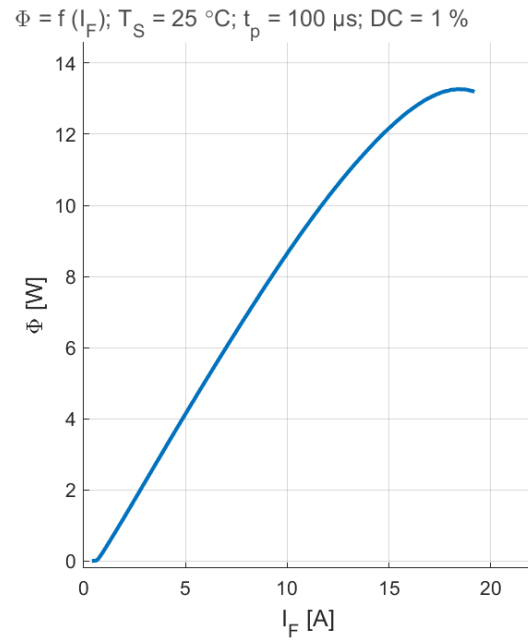

Relative Forward Voltage ¹⁾

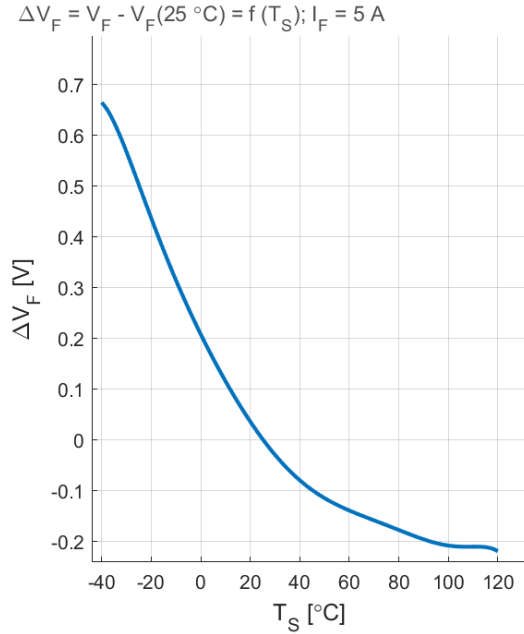

Relative Radiant Power ¹⁾

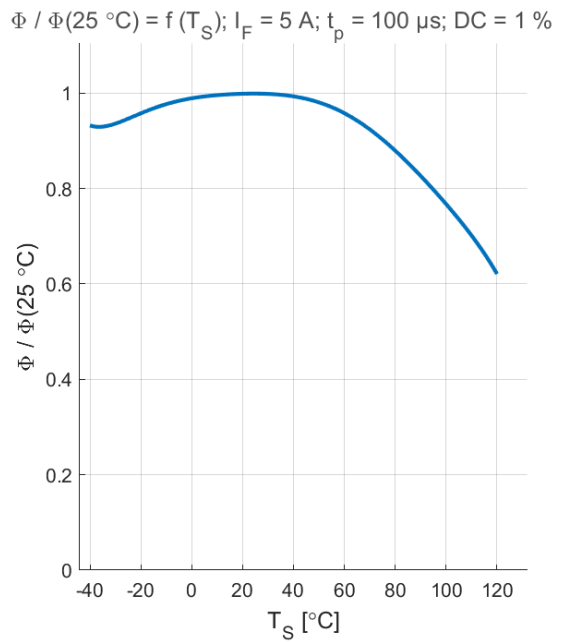

Max Permissible Pulse Current

$$I_F = f(T_S); t_p = 100 \mu\text{s}; \text{DC} = 1\%; R_{th, JS} = 15.9 \text{ K/W}$$

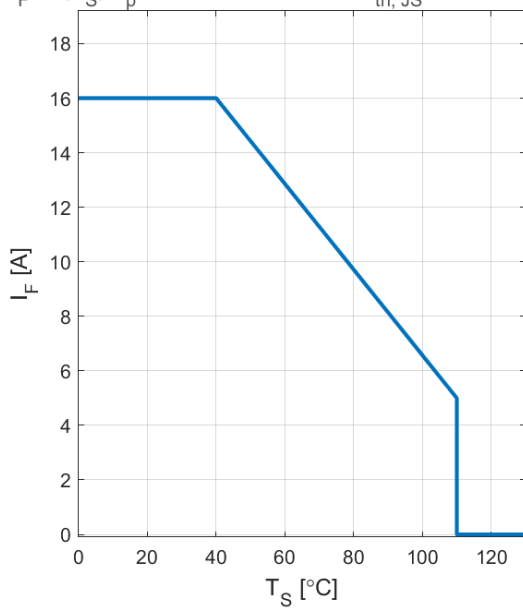

Max Permissible Current

$$I_F = f(T_S); \text{DC} = 100\%; R_{th, JS} = 15.9 \text{ K/W}$$

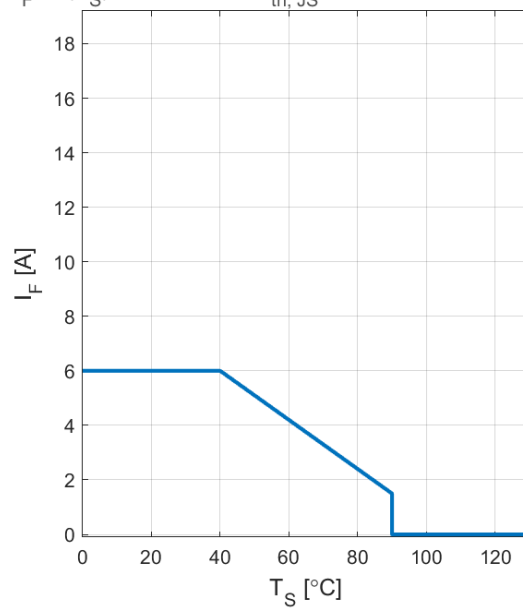

Dimension Drawings ³⁾

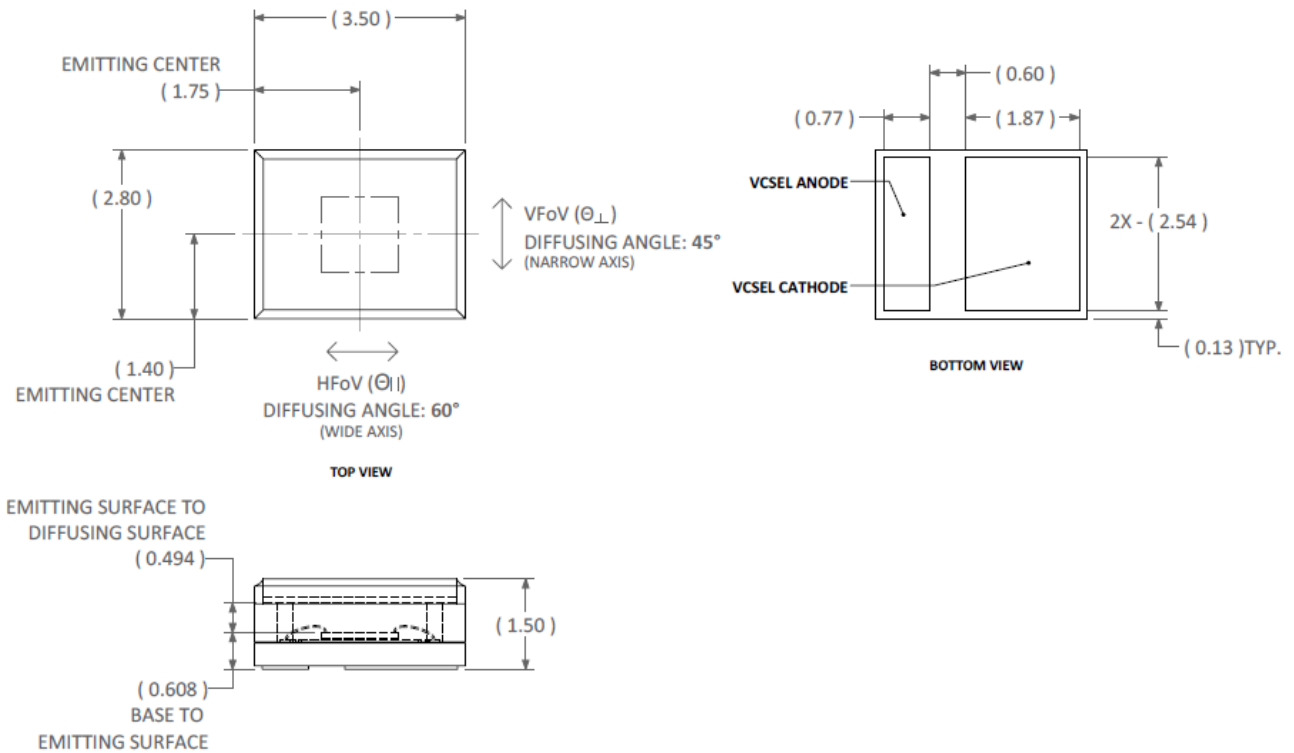

Further Information

Approximate Weight: 38 mg

Recommended Solder Pad Layout ³⁾

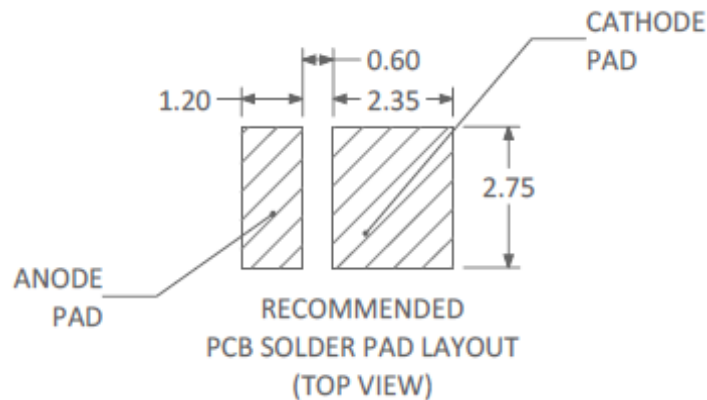

Reflow Soldering Profile

Product complies to MSL Level 2 acc. to JEDEC J-STD-020E

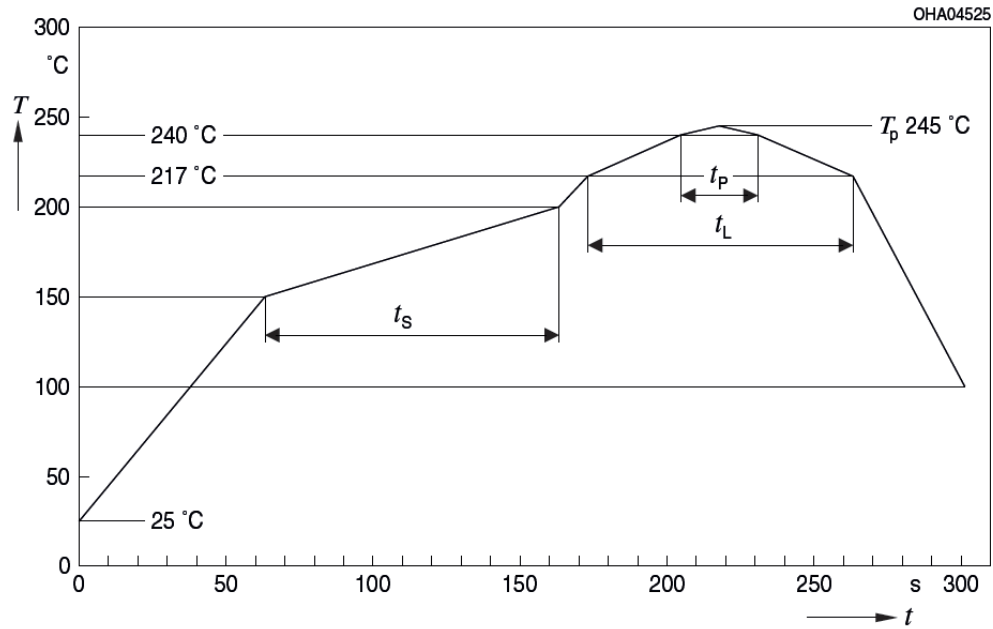

Profile Feature	Symbol	Pb-Free (SnAgCu) Assembly			Unit
		Minimum	Recommendation	Maximum	
Ramp-up rate to preheat*) 25°C to 150°C			2	3	K/s
Time t_s T_{smin} to T_{smax}	t_s	60	100	120	s
Ramp-up rate to peak*) T_{Smax} to T_P			2	3	K/s
Liquidus temperature	T_L		217		°C
Time above liquidus temperature	t_L		45	60	s
Peak temperature	T_P		245	260	°C
Time within 5 °C of the specified peak temperature $T_P - 5$ K	t_p	10	20	30	S
Ramp-down rate* T_P to 100°C			3	6	K/s
Time 25°C to T_P				480	s

All temperatures refer to the center of the package, measured on the top of the component

*slope calculation DT/Dt : Dt max. 5s; fulfillment for the whole T-range

Taping ^{3) 4)}

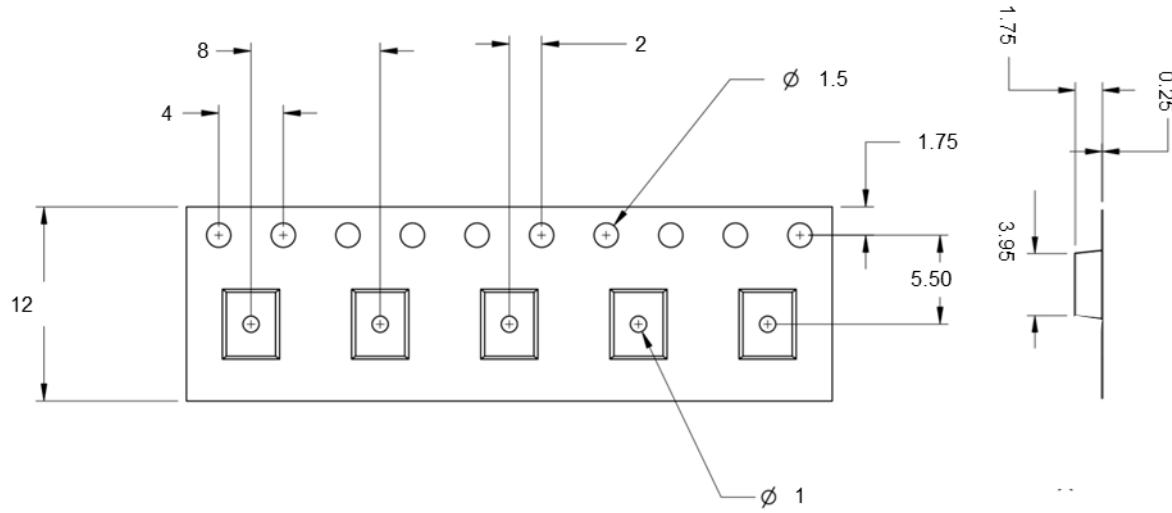

Tape and Reel ⁴⁾

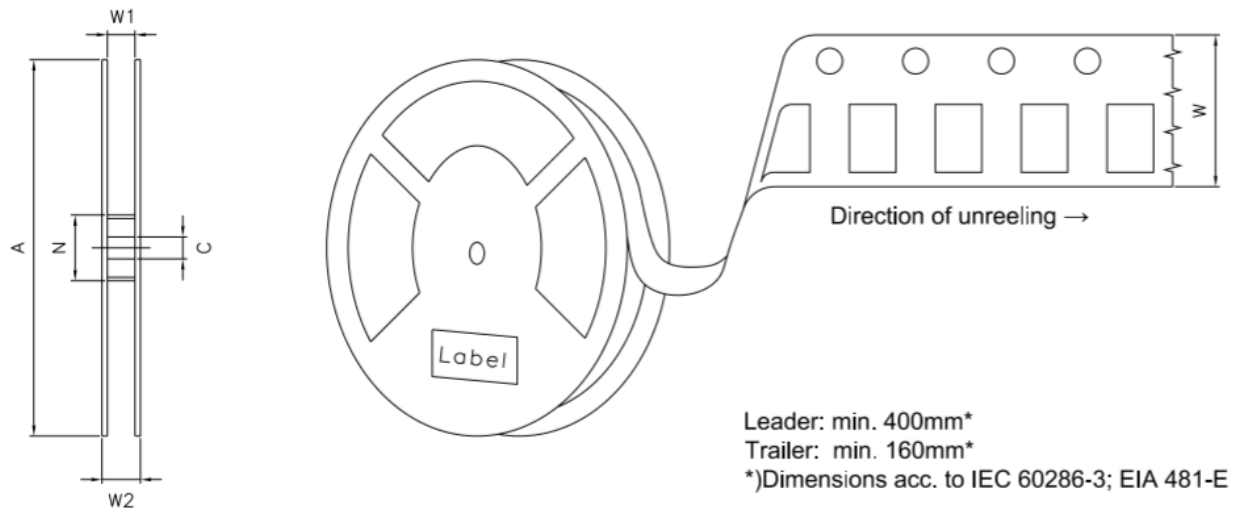

Reel dimensions [mm]

A	W	N _{min}	W ₁	W _{2 max}	Pieces per PU
330 mm	12 + 0.3 / - 0.1	60	12.4 + 2	18.4	2500

Barcode-Product-Label (BPL)

Vixar
a company of
OSRAM
Opto Semiconductors

LX XXXX BIN1:XX-XX-X-XXX-X

RoHS Compliant

(6P) BATCH NO: 1234567890

(1T) LOT NO: 1234567890 (9D) D/C: 1234

ML TEMP ST
2 260°C

Pack: RXX
DEMY XXX
X_X123_1234.1234 X

(X)PROD NO:123456789 (Q)QTY: 9999 (G)Group:XX-XX-X-X

Dry Packing Process and Materials

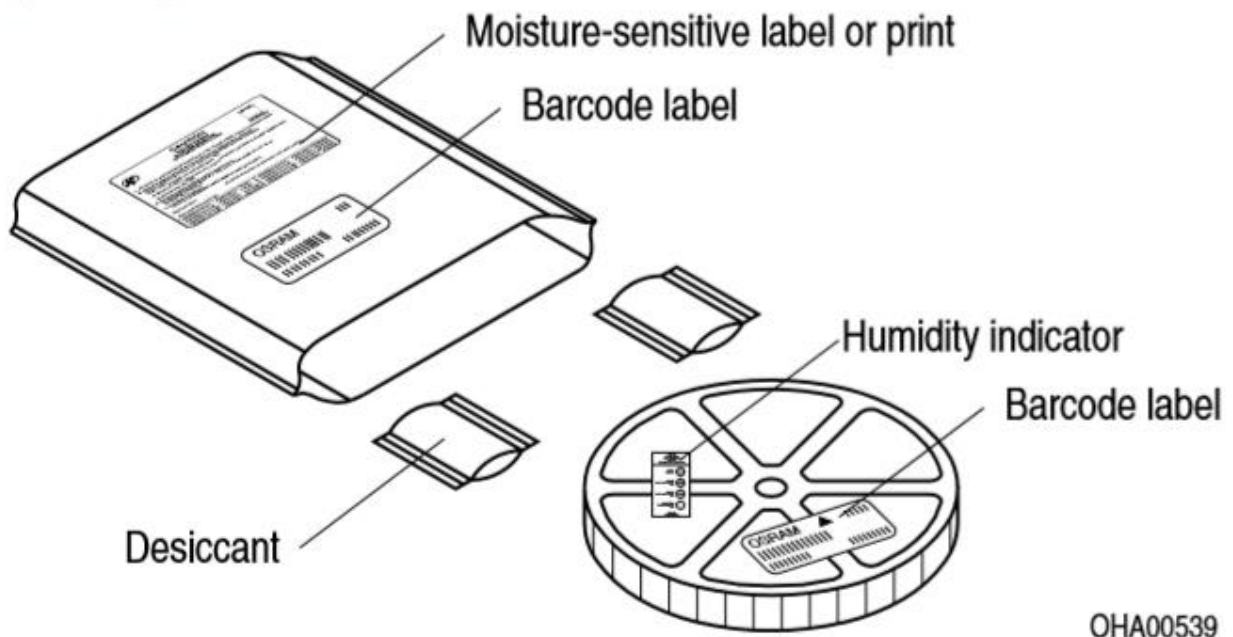

Moisture-sensitive product is packed in a dry bag containing desiccant and a humidity card according to JEDEC-STD-033.

Notes

Depending on the mode of operation, these devices emit highly concentrated visible and non-visible light which can be hazardous to the human eye. Products which incorporate these devices must follow the safety precautions given in IEC 60825-1.

Subcomponents of this device contain, in addition to other substances, metal filled materials including silver. Metal filled materials can be affected by environments that contain traces of aggressive substances. Therefore, we recommend that customers minimize device exposure to aggressive substances during storage, production, and use. Devices that showed visible discoloration when tested using the described tests above did show no performance deviations within failure limits during the stated test duration. Respective failure limits are described in the IEC60810.

For further application related information please visit www.osram-os.com/appnotes

Disclaimer

OSRAM OS assumes no liability whatsoever for any use of this document or its content by recipient including, but not limited to, for any design in activities based on this preliminary draft version. OSRAM OS may e.g. decide at its sole discretion to stop developing and/or finalizing the underlying design at any time.

Attention please!

The information describes the type of component and shall not be considered as assured characteristics. Terms of delivery and rights to change design reserved. Due to technical requirements components may contain dangerous substances.

For information on the types in question please contact our Sales Organization.

If printed or downloaded, please find the latest version on the OSRAM OS website.

Packing

Please use the recycling operators known to you. We can also help you – get in touch with your nearest sales office.

By agreement we will take packing material back, if it is sorted. You must bear the costs of transport. For packing material that is returned to us unsorted or which we are not obliged to accept, we shall have to invoice you for any costs incurred.

Product safety devices/applications or medical devices/applications

OSRAM OS components are not developed, constructed or tested for the application as safety relevant component or for the application in medical devices.

In case Buyer – or Customer supplied by Buyer– considers using OSRAM OS components in product safety devices/applications or medical devices/applications, Buyer and/or Customer has to inform the local sales partner of OSRAM OS immediately and OSRAM OS and Buyer and /or Customer will analyze and coordinate the customer-specific request between OSRAM OS and Buyer and/or Customer.

Glossary

- 1) **Typical Values:** Due to the special conditions of the manufacturing processes of semiconductor devices, the typical data or calculated correlations of technical parameters can only reflect statistical figures. These do not necessarily correspond to the actual parameters of each single product, which could differ from the typical data and calculated correlations or the typical characteristic line. If requested, e.g. because of technical improvements, these typ. data will be changed without any further notice.
- 2) **Testing temperature:** $T_a = 25^\circ\text{C}$
- 3) **Tolerance of Measure:** Unless otherwise noted in drawing, tolerances are specified with ± 0.1 and dimensions are specified in mm.
- 4) **Tape and Reel:** All dimensions and tolerances are specified acc. IEC 60286-3 and specified in mm.

Revision History

Version	Date	Change
0.0	Aug 2 nd , 2019	Initiation of preliminary datasheet
1.0	Feb 26 th , 2020	Application and Ordering information table update

Published by OSRAM Opto Semiconductors GmbH EU RoHS and China RoHS compliant product
Leibnizstraße 4, D-93055 Regensburg
www.osram-os.com © All Rights Reserved.



此产品符合欧盟 RoHS 指令的要求；
按照中国的相关法规和标准，不含有毒有害物质或元素。