

Inductors for power circuits
Thin-film metal magnetic material
TFM-ALVA series (for automotive)



AEC-Q200

TFM322512ALVA type



FEATURES

- By using metal magnetic material with high Saturation magnetic flux density the excellent DC bias characteristics needed for inductors for power circuits can be achieved.
- With the same product shape and terminal structure as general chip parts it has excellent mounting stability characteristics and can also be mounted to general-purpose land patterns.
- By using a closed magnetic circuit structure leakage flux is minimized.
- The rated voltage of 40V is realized by design that emphasizes voltage resistance.
- Operating temperature range: -55 to +150°C (including self-temperature rise)
- Compliant with AEC-Q200

APPLICATION

- For automotive (headlights, electronic power steering, meter cluster, ADAS ECU, other)

PART NUMBER CONSTRUCTION

| | | | | | | | |
|-------------|------------------------------------|---------------------|----------------|-----------------|----------------------|-----------------|---------------|
| TFM | 322512 | ALV | A | 4R7 | M | T | AA |
| Series name | LxWxH dimensions 3.2x2.5x1.2 mm | Characteristic type | Automotive use | Inductance (μH) | Inductance tolerance | Packaging style | Internal code |

CHARACTERISTICS SPECIFICATION TABLE

| L (μH) | Tolerance | L measuring frequency (MHz) | DC resistance | | Rated current* | | | | Rated voltage (V)max. | Part No. |
|--------|-----------|-----------------------------|---------------|----------|----------------|--------------|---------------|---------------|-----------------------|--------------------------------------|
| | | | (mΩ)max. | (mΩ)typ. | Isat (A)max. | Isat (A)typ. | Itemp (A)max. | Itemp (A)typ. | | |
| 1.0 | ±20% | 1 | 37 | 30 | 4.6 | 5.1 | 4.0 | 4.4 | 40 | TFM322512ALVA1R0MTAA |
| 1.5 | ±20% | 1 | 57 | 46 | 4.0 | 4.5 | 3.2 | 3.5 | 40 | TFM322512ALVA1R5MTAA |
| 2.2 | ±20% | 1 | 77 | 64 | 3.3 | 3.6 | 2.7 | 3.0 | 40 | TFM322512ALVA2R2MTAA |
| 3.3 | ±20% | 1 | 113 | 97 | 2.5 | 2.8 | 2.3 | 2.5 | 40 | TFM322512ALVA3R3MTAA |
| 4.7 | ±20% | 1 | 151 | 127 | 2.2 | 2.5 | 1.9 | 2.1 | 40 | TFM322512ALVA4R7MTAA |
| 6.8 | ±20% | 1 | 260 | 220 | 1.8 | 2.1 | 1.4 | 1.6 | 40 | TFM322512ALVA6R8MTAA |
| 10 | ±20% | 1 | 360 | 305 | 1.6 | 1.8 | 1.2 | 1.4 | 40 | TFM322512ALVA100MTAA |

* Rated current: smaller value of either Isat or Itemp.

Isat: When based on the inductance change rate (30% below the initial L value)

Itemp: When based on the temperature increase (temperature increase of 40°C by self heating)

Please refer to the graph of Rated current vs. temperature characteristics (derating) about the rating current at 85°C or more in temperature of the product.

Measurement equipment

| Measurement item | Product No. | Manufacturer |
|--------------------|------------------------|-----------------------|
| L | 4294A | Keysight Technologies |
| DC resistance | Digital Milliohm Meter | |
| Rated current Isat | 4285A+42841A+42842C | Keysight Technologies |

* Equivalent measurement equipment may be used.

TEMPERATURE RANGE, INDIVIDUAL WEIGHT

| Operating temperature range* | Storage temperature range** | Individual weight |
|------------------------------|-----------------------------|-------------------|
| -55 to +150 °C | -55 to +150 °C | 0.052 g |

* Operating temperature range includes self-temperature rise.

** The storage temperature range is for after the assembly.

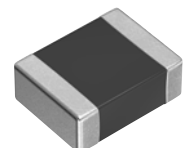

TFM322512ALVA type

L FREQUENCY CHARACTERISTICS

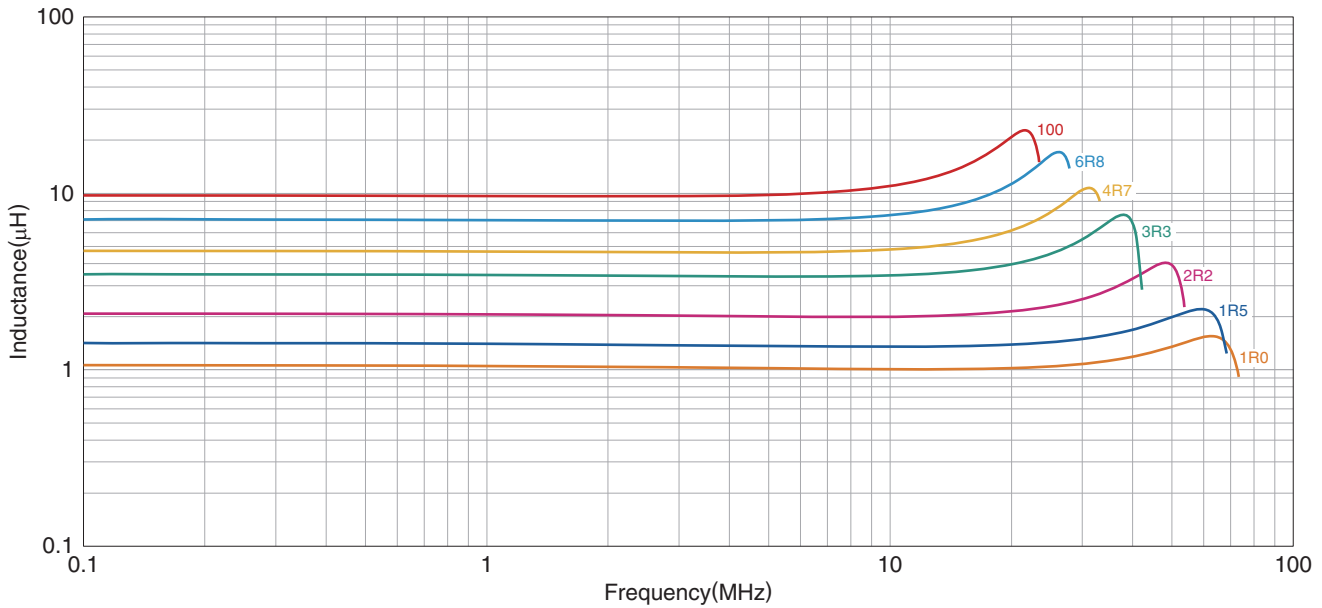

Measurement equipment

| Product No. | Manufacturer |
|-------------|-----------------------|
| 4294A | Keysight Technologies |

* Equivalent measurement equipment may be used.

INDUCTANCE VS. DC BIAS CHARACTERISTICS

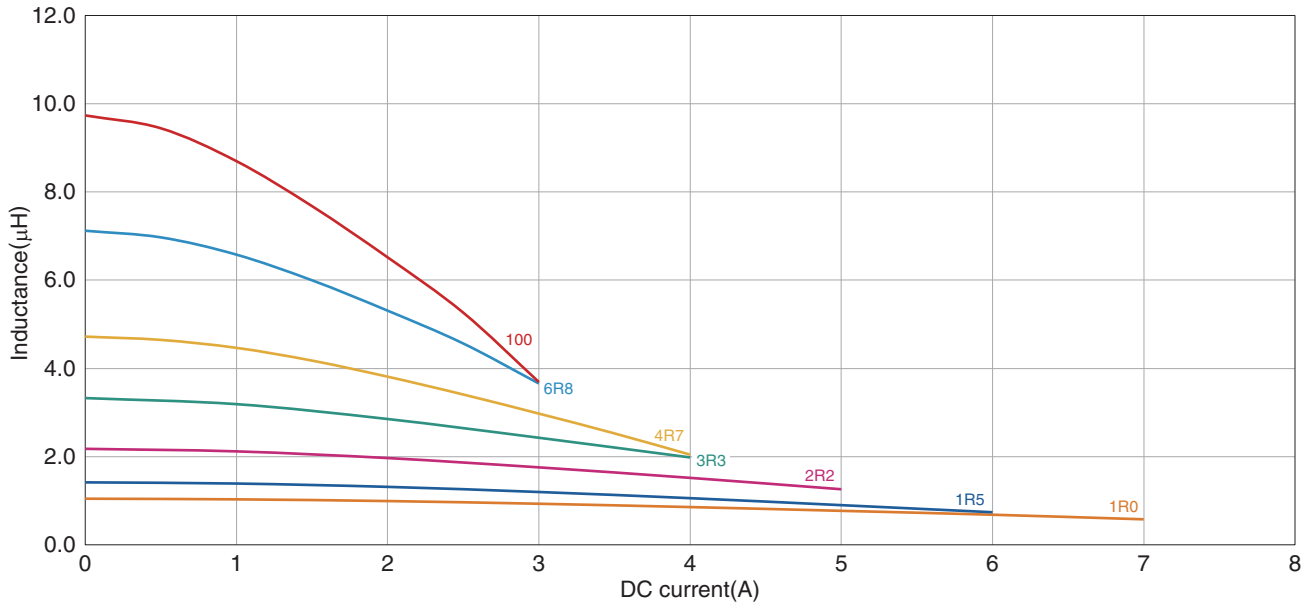

Measurement equipment

| Product No. | Manufacturer |
|---------------------|-----------------------|
| 4285A+42841A+42842C | Keysight Technologies |

* Equivalent measurement equipment may be used.

TFM322512ALVA type

SHAPE & DIMENSIONS

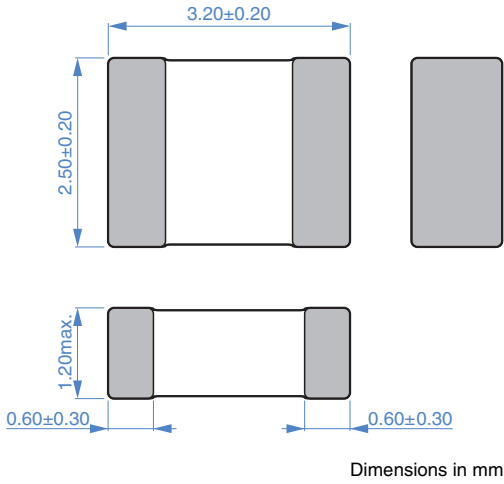

PACKAGING STYLE

REEL DIMENSIONS

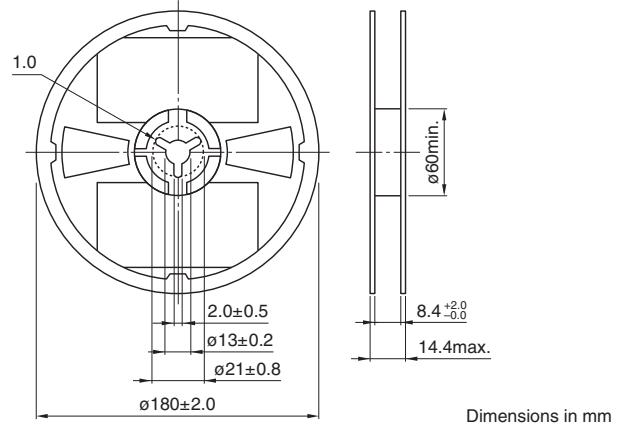

RECOMMENDED LAND PATTERN

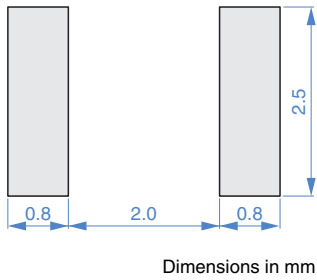

TAPE DIMENSIONS

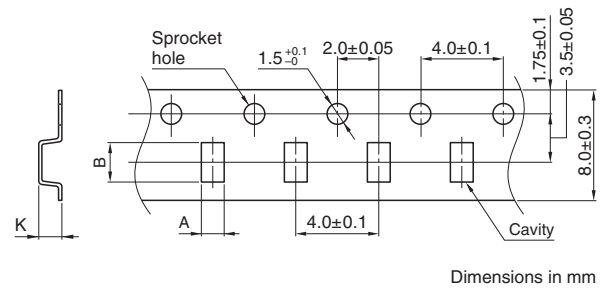

| Type | A | B | K |
|---------------|-----|-----|-----|
| TFM322512ALVA | 2.8 | 3.5 | 1.4 |

RECOMMENDED REFLOW PROFILE

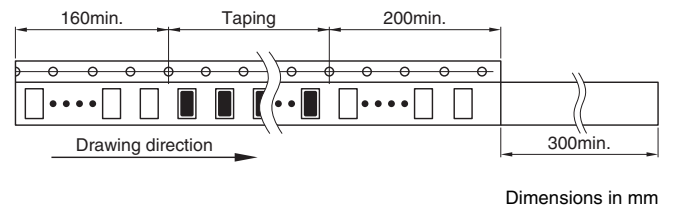
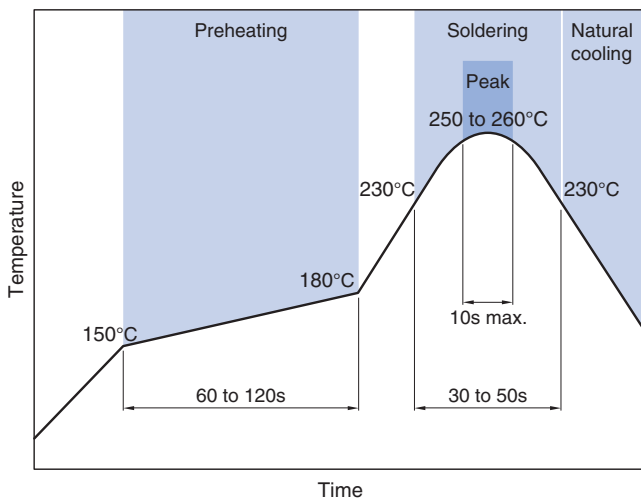

PACKAGE QUANTITY

| | |
|------------------|---------------|
| Package quantity | 2000 pcs/reel |
|------------------|---------------|

REMINDERS FOR USING THESE PRODUCTS

Before using these products, be sure to request the delivery specifications.

SAFETY REMINDERS

Please pay sufficient attention to the warnings for safe designing when using this products.

REMINDERS

- The storage period is within 6 months. Be sure to follow the storage conditions (temperature: 5 to 40°C, humidity: 20 to 75% RH or less).
If the storage period elapses, the soldering of the terminal electrodes may deteriorate.
- Do not use or store in locations where there are conditions such as gas corrosion (salt, acid, alkali, etc.).
- Before soldering, be sure to preheat components.
The preheating temperature should be set so that the temperature difference between the solder temperature and chip temperature does not exceed 150°C.
- Soldering corrections after mounting should be within the range of the conditions determined in the specifications.
If overheated, a short circuit, performance deterioration, or lifespan shortening may occur.
- When embedding a printed circuit board where a chip is mounted to a set, be sure that residual stress is not given to the chip due to the overall distortion of the printed circuit board and partial distortion such as at screw tightening portions.
- Self heating (temperature increase) occurs when the power is turned ON, so the tolerance should be sufficient for the set thermal design.
- Carefully lay out the coil for the circuit board design of the non-magnetic shield type.
A malfunction may occur due to magnetic interference.
- Use a wrist band to discharge static electricity in your body through the grounding wire.
- Do not expose the products to magnets or magnetic fields.
- Do not use for a purpose outside of the contents regulated in the delivery specifications.
- The products listed on this catalog are intended for use in general electronic equipment (AV equipment, telecommunications equipment, home appliances, amusement equipment, computer equipment, personal equipment, office equipment, measurement equipment, industrial robots) under a normal operation and use condition.
The products are not designed or warranted to meet the requirements of the applications listed below, whose performance and/or quality require a more stringent level of safety or reliability, or whose failure, malfunction or trouble could cause serious damage to society, person or property.
If you intend to use the products in the applications listed below or if you have special requirements exceeding the range or conditions set forth in the each catalog, please contact us.

- (1) Aerospace/aviation equipment
- (2) Transportation equipment (electric trains, ships, etc.)
- (3) Medical equipment
- (4) Power-generation control equipment
- (5) Atomic energy-related equipment
- (6) Seabed equipment
- (7) Transportation control equipment

- (8) Public information-processing equipment
- (9) Military equipment
- (10) Electric heating apparatus, burning equipment
- (11) Disaster prevention/crime prevention equipment
- (12) Safety equipment
- (13) Other applications that are not considered general-purpose applications

When designing your equipment even for general-purpose applications, you are kindly requested to take into consideration securing protection circuit/device or providing backup circuits in your equipment.