

KEMET, L-DMI, Power, 4.7 uH, 20%

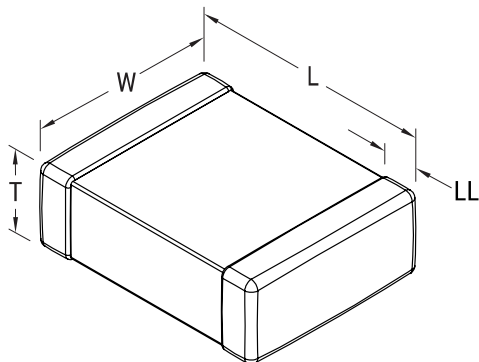

Dimensions	
Chip Size	1008
L	2.5mm +/-0.2mm
W	2mm +/-0.2mm
T	1mm MAX
LL	0.5mm +/-0.3mm

Packaging Specifications	
Packaging:	T&R
Packaging Quantity:	3000

General Information	
Series:	L-DMI
Style:	SMD Chip
Description:	Shielded, Surface Mount Inductor
Features:	High Current Type For Power Supply Line
RoHS:	Yes
Winding Type:	Multilayer

Specifications	
Inductance:	4.7 uH (1 MHz)
Inductance Tolerance:	20%
Temperature Range:	-40/+85°C
Shielded:	Yes
Current:	1100 mAmps (MAX)
DC Resistance:	0.15 Ohms