

KEMET, Z-SMS, Ferrite Beads, Noise Suppression, 300 mOhms

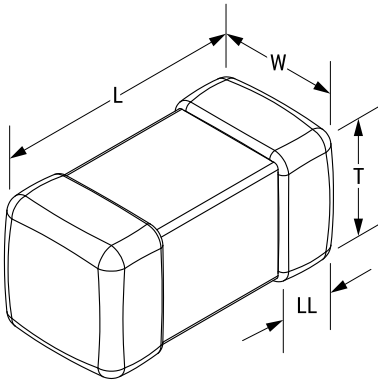

Dimensions	
Chip Size	0805
L	2mm +0.3/-0.1mm
W	1.25mm +/-0.2mm
T	0.85mm +/-0.2mm
B	0.5mm +/-0.3mm

Packaging Specifications	
Packaging:	T&R
Packaging Quantity:	4000

General Information	
Series:	Z-SMS
Style:	SMD Chip
Description:	Chip Bead Signal Line
Features:	Designed As A Noise Countermeasure For 200MHz-500MHz Range Where The Rise Of The Z Component Is In The High Frequency Area
RoHS:	Yes
Notes:	Internal Silver Printed Layer Creates A Closed Circuit Which Acts As A Magnetic Shield To Minimize Heat Generation And Crosstalk

Specifications	
Impedance:	120 Ohms (100 mHz)
Impedance Tolerance:	25%
Ripple Current:	400 mA (MAX)
Temperature Range:	-55/+125°C
Resistance:	0.3 Ohms

Statements of suitability for certain applications are based on our knowledge of typical operating conditions for such applications, but are not intended to constitute - and we specifically disclaim - any warranty concerning suitability for a specific customer application or use. This Information is intended for use only by customers who have the requisite experience and capability to determine the correct products for their application. Any technical advice inferred from this Information or otherwise provided by us with reference to the use of our products is given gratis, and we assume no obligation or liability for the advice given or results obtained.