



# Ledinaire floodlight

## BVP154 LED10/840 PSU 10W VWB MDU CE

LED Module 1000 lm - 840 neutral white - Power supply unit - Very wide beam angle 100° - Movement detection unit

The Ledinaire range contains a selection of popular off-the-shelf LED luminaires that comes with the Philips high quality levels at a competitive price. Reliable, energy-efficient and affordable – just what you need.

### Product data

General Information	
Lamp family code	LED10 [ LED Module 1000 lm]
Light source color	840 neutral white
Light source replaceable	No
Number of gear units	-
Driver/power unit/transformer	Power supply unit
Driver included	Yes
Optical cover/lens type	Clear glass
Luminaire light beam spread	100°
Embedded control	Movement detection unit
Control interface	-
Connection	Flying leads/wires
Cable	Cable 1.0 m without plug
Protection class IEC	Safety class I
Flammability mark	-
CE mark	CE mark
ENEC mark	-
Warranty period	3 years
Optic type outdoor	Very wide beam angle 100°
Constant light output	No

Number of products on MCB of 16 A type B	220
EU RoHS compliant	Yes
Light source engine type	LED

Light Technical	
Upward light output ratio	0
Standard tilt angle posttop	0°
Standard tilt angle side entry	0°

Operating and Electrical	
Input Voltage	220 to 240 V
Input Frequency	50 or 60 Hz
Initial CLO power consumption	- W
Average CLO power consumption	- W
End CLO power consumption	- W
Inrush current	0.54 A
Inrush time	0.0054 ms
Power Factor (Min)	0.7

# Ledinaire floodlight

## Controls and Dimming

Dimmable	No
----------	----

## Mechanical and Housing

Housing Material	Aluminum die cast
Reflector material	Polycarbonate
Optic material	Polycarbonate
Optical cover/lens material	Glass
Fixation material	Steel
Mounting device	Mounting bracket adjustable
Optical cover/lens shape	Flat
Optical cover/lens finish	Clear
Overall length	150 mm
Overall width	35 mm
Overall height	160 mm
Effective projected area	0.018 m <sup>2</sup>
Color	Aluminum and gray
Dimensions (Height x Width x Depth)	160 x 35 x 150 mm (6.3 x 1.4 x 5.9 in)

## Approval and Application

Ingress protection code	IP65 [ Dust penetration-protected, jet-proof]
Mech. impact protection code	IK07 [ 2 J reinforced]
Surge Protection (Common/Differential)	Surge protection level until 2 kV

## Initial Performance (IEC Compliant)

Initial luminous flux (system flux)	1050 lm
Luminous flux tolerance	+/-10%
Initial LED luminaire efficacy	105 lm/W

Init. Corr. Color Temperature	4000 K
Init. Color Rendering Index	80
Initial chromaticity	<7 SDCM
Initial input power	10 W
Power consumption tolerance	+/-10%

## Over Time Performance (IEC Compliant)

Control gear failure rate at median useful life	10 %
50000 h	
Lumen maintenance at median useful life*	L70
50000 h	

## Application Conditions

Ambient temperature range	-25 to +40 °C
Maximum dim level	Not applicable

## Product Data

Full product code	871016333132499
Order product name	BVP154 LED10/840 PSU 10W VWB MDU CE
EAN/UPC - Product	8710163331324
Order code	911401733342
Numerator - Quantity Per Pack	1
Numerator - Packs per outer box	18
Material Nr. (12NC)	911401733342
Net Weight (Piece)	0.650 kg



## Dimensional drawing

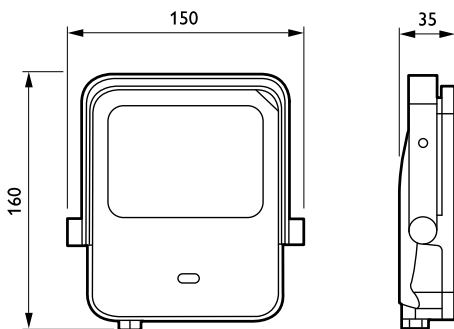

Ledinaire floodlight BVP105/106

## Ledinaire floodlight

