

TECHNICAL SPECIFICATIONS

- Material:** Zinc, Nickel plated
- Operating Temperature:** -30°C to 90°C
- Attenuation Factor:** >40 dB between 30 MHz and 1 GHz
- Cable Entry:** Top
- Thumbscrews:** UNC 4-40 (standard)
M2,5/M2,6 or M3,0 on request
- Cable Diameter:** Up to 13,0 mm
- Accessories:** See page 40-43

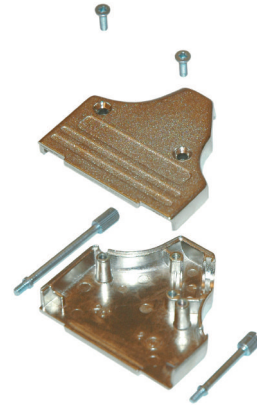

Features:

- Available in sizes 9-15-25-37
- 360° EMI Shielding
- 3 versions of same concept
- Quick assembly
- Supports all types of cables
- Suitable for any common D-Sub connector

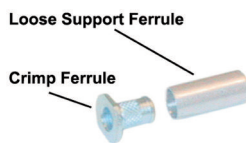
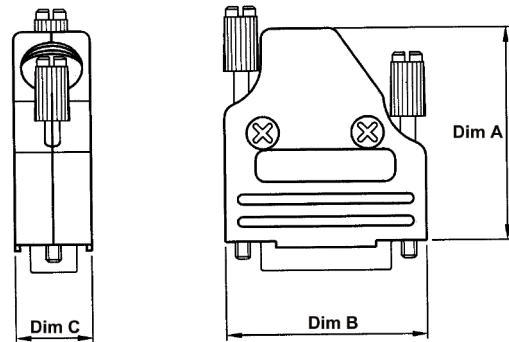

MHC35-Series

- Crimp Method
- 360° Shielding
- For use with braided cable only



MHDM35-Series

- Easy assembly
- 360° Shielding
- Metalized plastic insert

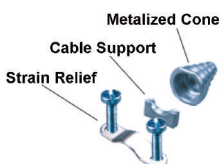

MHEE35-Series

- Easy assembly
- 360° Shielding
- Metalized plastic grommet
- The grommet can be adapted to fit any cable size by simple cutting.

Size MHulti-35°	Dim A	Dim B	Dim C
9-way	43,0	32,0	15,5
15-way	43,0	40,4	15,5
25-way	48,0	54,0	15,5
37-way	53,0	70,5	15,5

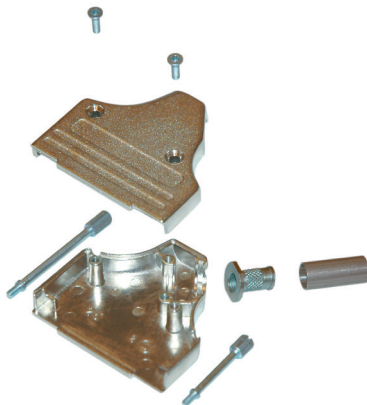

Order Code

MHC35 - XX - B - K

Series: _____

Size (xx): 9,15, 25, 37 _____

Plating Select: _____
 Omit = Nickel
B = Black Chromate

Packing Style: _____
K = Individual Kit
 Omit = Bulk

Crimp Dies and Crimp Tool: See page 78

Order codes	Ferrule Kits:	Die No:
MHC5.3	5,3 mm ferrule Kit	8.0
MHC6.0	6,0 mm ferrule Kit	10.0
MHC7.0	7,0 mm ferrule Kit	11.5
MHC7.5	7,5 mm ferrule Kit	12.0
MHC8.6	8,6 mm ferrule Kit	12.5

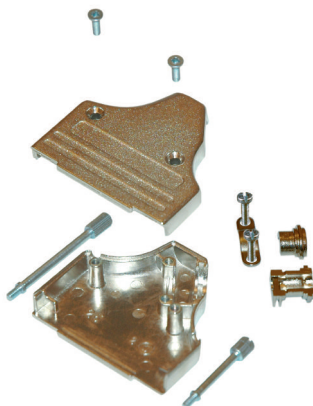

Order Code

MHDM35 - XX - B - K

Series: _____

Size (xx): 9,15, 25, 37 _____

Plating Select: _____
 Omit = Nickel
B = Black Chromate

Packing Style: _____
K = Individual Kit
 Omit = Bulk

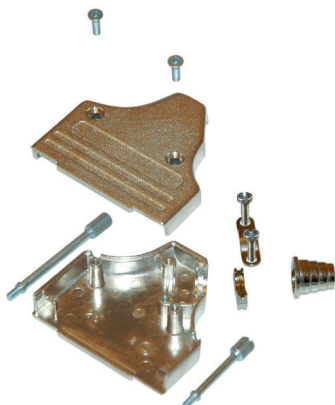

Order Code

MHEE35 - XX - B - K

Series: _____

Size (xx): 9,15, 25, 37 _____

Plating Select: _____
 Omit = Nickel
B = Black Chromate

Packing Style: _____
K = Individual Kit
 Omit = Bulk