

Toggle Switches

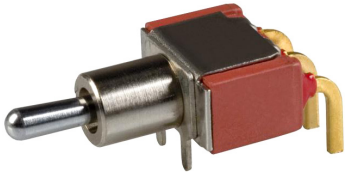

Specifications

Electrical:

Max. Contact Rating : Gold: 0.4VA at 20V (AC or DC)
 Max. Contact Resistance : 10mΩ
 Min. Insulation Resistance : 1,000MΩ at 500V DC
 Dielectric Strength : 1,000 V rms

Mechanical:

Life : 40,000 Cycles

Environmental:

Operating Temperature : -30°C to +85°C

Material:

Case : DAP
 Housing : Stainless steel
 Actuator : Brass, chrome plated
 Bushing : Brass, nickel plated
 Support : Brass, tin plated
 Contact / Terminals : Copper alloy, gold plated

Diagram

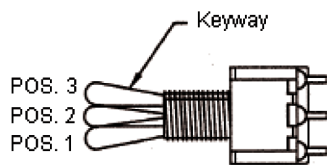
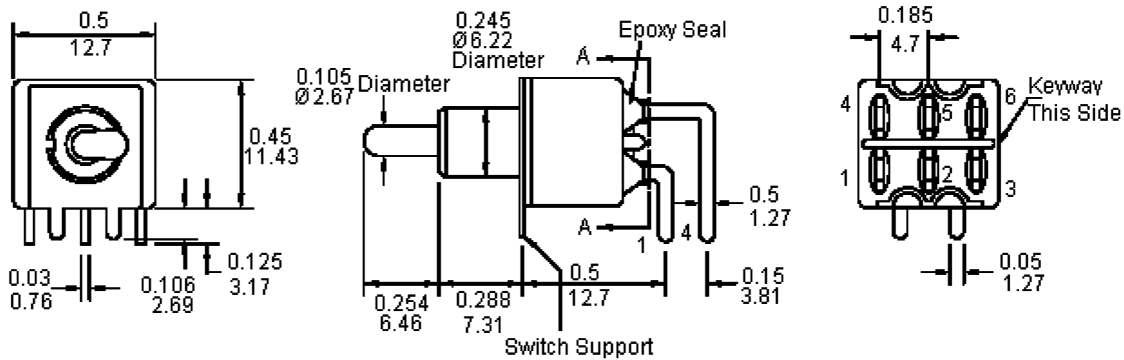

Single Pole, 3 Positions

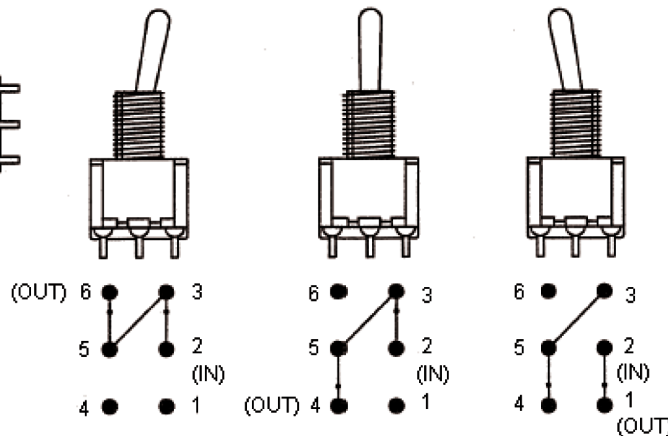
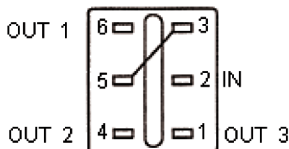





Three-Way Switch Wiring Diagram

Dimensions : Inches (Millimetres)

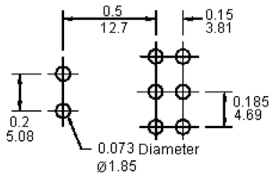
Toggle Switches

PCB Layout Component Side



Part Number	Switching Position		
			
SPC21216	ON	ON	ON
SPC21217	MOM	ON	MOM
SPC21218	ON	ON	MOM
Conn. Terms	2-3 5-6	2-3 5-4	2-1 5-4

Dimensions : Inches (Millimetres)

Actuator

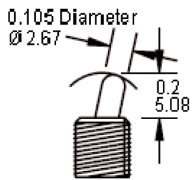

Bushing

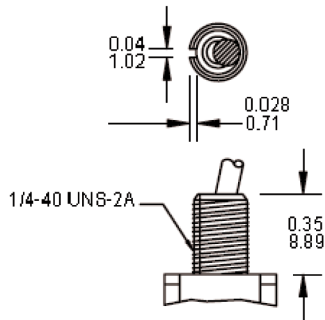

Standard Nut

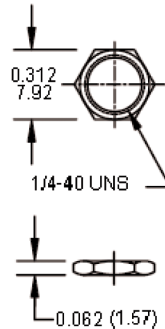

Lock Washer

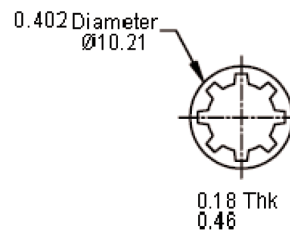

Locking Ring

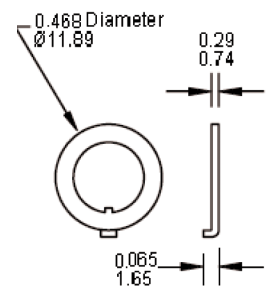

Panel Mounting

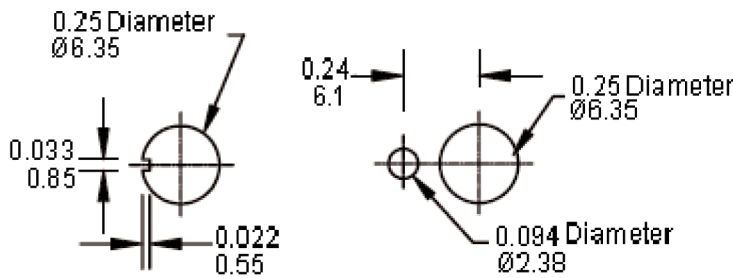

Dimensions : Inches (Millimetres)

Part Number Table

Description	Part Number
Toggle Switch	SPC21216
	SPC21217
	SPC21218

Important Notice : This data sheet and its contents (the "Information") belong to the members of the AVNET group of companies (the "Group") or are licensed to it. No licence is granted for the use of it other than for information purposes in connection with the products to which it relates. No licence of any intellectual property rights is granted. The Information is subject to change without notice and replaces all data sheets previously supplied. The Information supplied is believed to be accurate but the Group assumes no responsibility for its accuracy or completeness, any error in or omission from it or for any use made of it. Users of this data sheet should check for themselves the Information and the suitability of the products for their purpose and not make any assumptions based on information included or omitted. Liability for loss or damage resulting from any reliance on the Information or use of it (including liability resulting from negligence or where the Group was aware of the possibility of such loss or damage arising) is excluded. This will not operate to limit or restrict the Group's liability for death or personal injury resulting from its negligence. Multicomp Pro is the registered trademark of Premier Farnell Limited 2019.