

Data sheet | Item number: 221-485

COMPACT Splicing Connector; for all conductor types; for Ex e applications;
max. 4 mm²; 5-conductor; with levers; transparent housing; Operating
temperature (max.): 105 °C; 4,00 mm²; transparent

www.wago.com/221-485

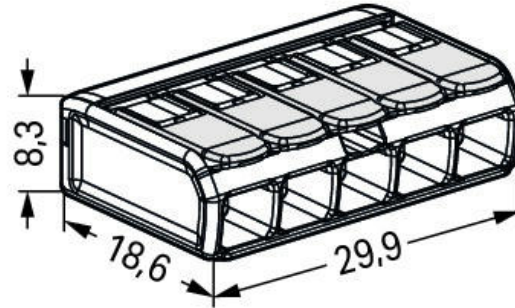
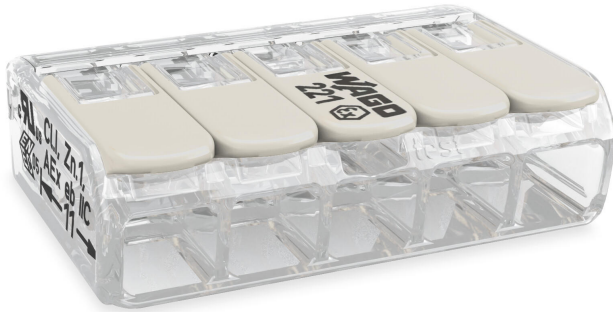

RoHS 
Compliant

[BOMcheck.net](https://www.bomcheck.net)

Item description

Your Benefits:

- Ease of use – pull the lever up, insert a conductor and push the lever back down
- Available as 2-, 3- and 5-wire connectors
- Easily terminate conductors from 0.14 to 4 mm²
- Connect solid, stranded and fine-stranded conductors
- Time savings for installers and device manufacturers
- Quickly install devices with higher levels of power consumption
- Safely install long cable runs with larger conductor cross sections
- Mounting carrier for installation conforms to standards
- Working voltages of 275 V or 440 V
- Custom carriers are possible
- ATEX (Ex 2 II G), IECEx (Ex eb IIC Gb) Zone 1, 2
- IECEx (Ex eb IIC Gb), American Ex (AEx eb IICGb) / Class 1, Zone 1

Safety information 1:

The permissible operating voltage of the connector with carrier (440 V or 275 V) depends on the mounting type.

Safety information 2:

Only approved in conjunction with a mounting carrier (221-501). Other carriers are possible, see certificate/file. The connectors must be installed in

Subject to changes. Please also observe the further product documentation!

WAGO Kontakttechnik GmbH & Co. KG
Hansastr. 27
32423 Minden
Phone: +49571 887-0 | Fax: +49571 887-169
Email: info.de@wago.com | Web: www.wago.com

Do you have any questions about our products?
We are always happy to take your call at +49 (571) 887-44222.



an enclosure meeting the requirements of a recognized protection type per EN 60079-0, Section 1 or EN 60079-31. When installing the connectors in an enclosure of protection type "eb" (increased safety) per EN 60079-7, the clearances and creepage distances of Table 2 for this standard must be observed. See point 1 for the use of accessories. The connectors can be used both in Group II and Group I, as the standard requirements are identical in this case.

The use of these components requires a new assessment by a notified certification agency.

Data

Electrical data

Ratings per IEC/EN 60664-1

Ratings per	IEC/EN 60079-7
-------------	----------------

Ratings per UL 1059

Approvals per	UL 60079
Rated voltage UL (Use Group C)	440 V
Rated current UL (Use Group C)	20 A

Ex information

Ratings per	ATEX: PTB 18 ATEX 1019 U / IECEx: PTB 18.0045U (Ex eb IIC Gb)
Rated voltage EN (Ex e II)	440 V
Rated current (Ex e II)	32 A

Connection data

Connection technology	CAGE CLAMP®
Actuation type	Lever
Connectable conductor materials	Copper
Nominal cross-section	4 mm ²
Solid conductor	0.2 ... 4 mm ² / 24 ... 12 AWG
Stranded conductor	0.2 ... 4 mm ² / 24 ... 12 AWG
Fine-stranded conductor	0.14 ... 4 mm ² / 24 ... 12 AWG
Strip length	11 mm / 0.43 inch
Total number of connection points	5
Total number of potentials	1
Wiring type	Side-entry wiring

Physical data

Width	29.9 mm / 1.177 inch
-------	----------------------

Subject to changes. Please also observe the further product documentation!

Height	8.3 mm / 0.327 inch
Depth	18.6 mm / 0.732 inch

Material Data

Color	transparent
Flammability class per UL94	V2
Color of actuator	light gray
Weight	4.4 g

Environmental Requirements



Continuous operating temperature	105 ... 105 °C
----------------------------------	----------------

Commercial data

Packaging type	BOX
Country of origin	DE
GTIN	4055143837330
Customs tariff number	85369010000

Approvals / Certificates

Ex-Approvals



Logo	Approval	Additional Approval Text	Certificate name
	AEx Underwriters Laboratories Inc.	UL 60079	20190228- E185892
	ATEX Physikalisch Technische Bundesanstalt	IEC 60079-0	PTB 18 ATEX 1019 U
	IECEX Physikalisch Technische Bundesanstalt	IEC 60079-0	IECEX PTB 18.0045U (Ex eb IIC Gb)

Country specific Approvals

Logo	Approval	Additional Approval Text	Certificate name
	CCA DEKRA Certification B.V.	EN 60998	NTR NL- 7642

Subject to changes. Please also observe the further product documentation!

CCA

	CCA DEKRA Certification B.V.	EN 60998	71- 101731
	EAC Brjansker Zertifizierungsstelle	TP TC 012/2011	RU C-DE. AM02.B. 00127/19



Ship Approvals

Logo	Approval	Additional Approval Text	Certificate name
	LR Lloyds Register	EN 60998	04/20013 (E8)

Counterpart

Compatible products

Mounting adapter

	Item no.: 221-500/000-006 Mounting carrier; 221 Series - 4 mm ² ; for DIN-35 rail mounting/screw mounting; blue	www.wago.com/221-500/000-006
	Item no.: 221-501 Mounting carrier; for Ex applications; 221 Series - 4 mm ² ; for DIN-35 rail mounting/screw mounting; light gray	www.wago.com/221-501

Downloads

Documentation

Bid Text

221-485 GAEB X81 - Datei	21-May-2019	xml 4.2 kB	Download
221-485	21-May-2019	docx	Download

Subject to changes. Please also observe the further product documentation!

WAGO Kontakttechnik GmbH & Co. KG
Hansastr. 27
32423 Minden
Phone: +49571 887-0 | Fax: +49571 887-169
Email: info.de@wago.com | Web: www.wago.com

Do you have any questions about our products?
We are always happy to take your call at +49 (571) 887-44222.

GAEB docx - Datei

16.4 kB

Additional Information

Technical explanations

03-Apr-2019

pdf
2.2 MB

Download

System Description

System Description 221-482, 221-483, 221-485

pdf
1.2 MB

Download

System Description 221-482, 221-483, 221-485

CAD/CAE-Data

CAD data

2D/3D Models 221-485

URL

Download

CAE data

ZUKEN Portal 221-485

URL

Download

Installation Notes

Conductor termination

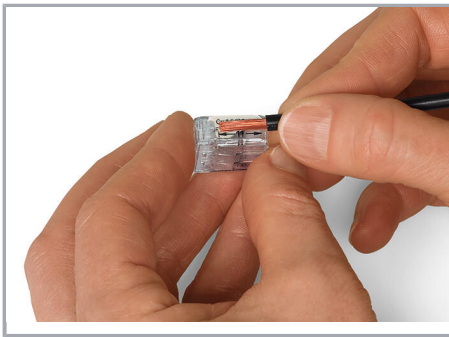

Strip conductor to 11 mm (0.43 inch).

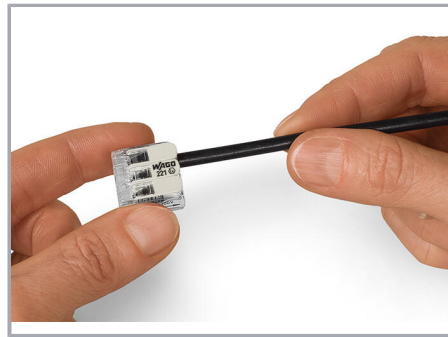

Then, lower the lever to close the clamp.

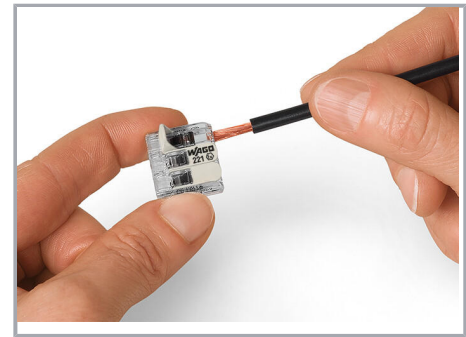

Termination: Lift the lever to open the clamping unit and insert a stripped conductor.

Installation

Subject to changes. Please also observe the further product documentation!

WAGO Kontakttechnik GmbH & Co. KG

Hansastr. 27

32423 Minden

Phone: +49571 887-0 | Fax: +49571 887-169

Email: info.de@wago.com | Web: www.wago.com

Do you have any questions about our products?

We are always happy to take your call at +49 (571) 887-44222.

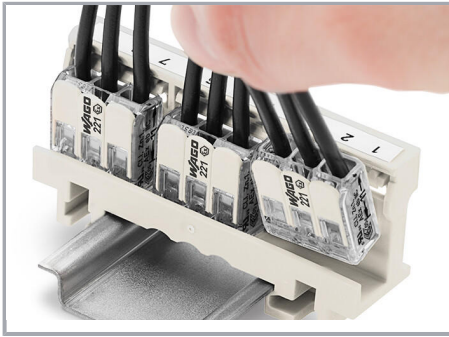

Inserting a connector into the mounting carrier.

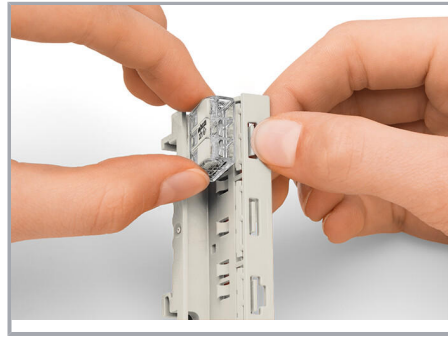

Removing a connector from the mounting carrier.

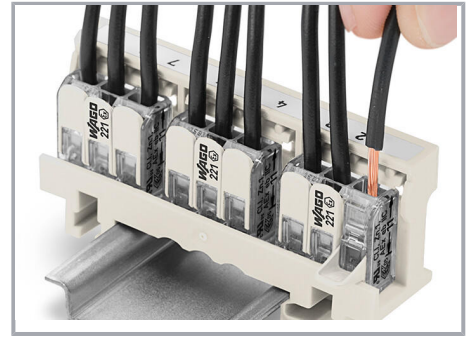

Removing a conductor.

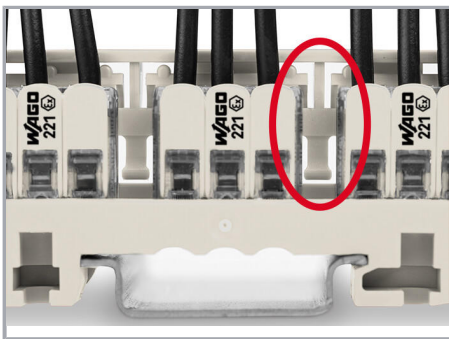

Mounting type (440 V)
Using spacers between the connectors.



Mounting type (440 V)
Vertical mounting on DIN-35 rail

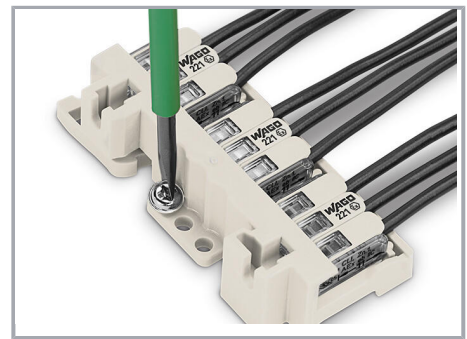

Mounting type (440 V)
Horizontal screw mounting on a flat surface

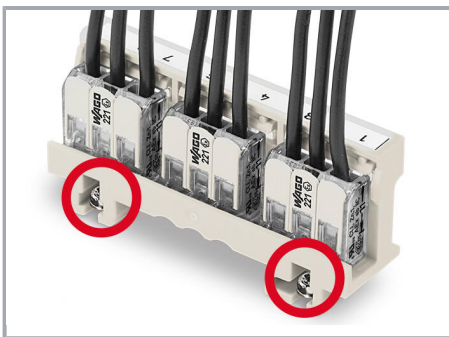

Mounting type (440 V)
Mounting the carrier via non-conductive screws.

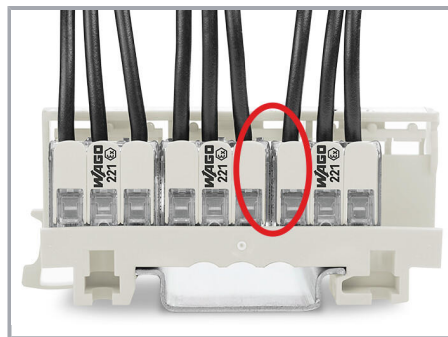

Mounting type (275 V)
No spacers are used between the connectors.

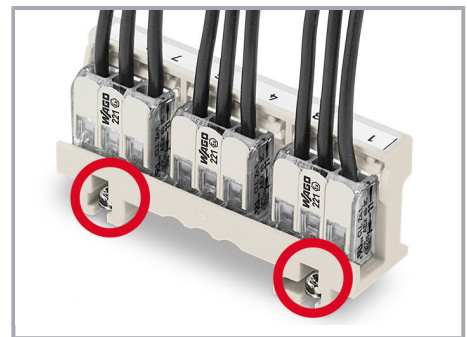

Mounting type (275 V)
Mounting the carrier using conductive screws.

Testing

Subject to changes. Please also observe the further product documentation!

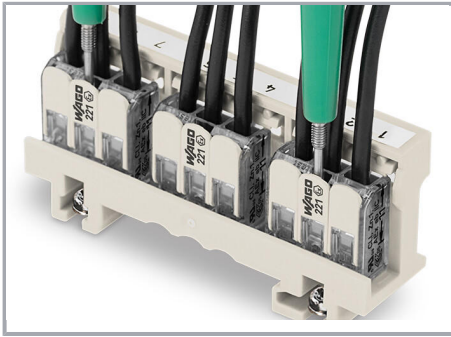

Easily test inserted connectors in the carrier
– without considering the type of mounting.

Subject to changes. Please also observe the further product documentation!