

**Leistungsstarke IR-Lumineszenzdiode**  
**High Power Infrared Emitter**  
**Lead (Pb) Free Product - RoHS Compliant**

**SFH 4209**



**Wesentliche Merkmale**

- Leistungsstarke GaAs-LED (40mW)
- Hoher Wirkungsgrad bei kleinen Strömen
- Typische Peakwellenlänge 950nm

**Features**

- High Power GaAs-LED (40mW)
- High Efficiency at low currents
- Typical peak wavelength 950nm

**Anwendungen**

- Schnelle Datenübertragung mit Übertragungsraten bis 100 Mbaud (IR Tastatur, Joystick, Multimedia)
- Analoge und digitale Hi-Fi Audio- und Videosignalübertragung
- Batteriebetriebene Geräte (geringe Stromaufnahme)
- Anwendungen mit hohen Zuverlässigkeitsansprüchen bzw. erhöhten Anforderungen
- Alarm- und Sicherungssysteme
- IR Freiraumübertragung

**Applications**

- High data transmission rate up to 100 Mbaud (IR keyboard, Joystick, Multimedia)
- Analog and digital Hi-Fi audio and video signal transmission
- Low power consumption (battery) equipment
- Suitable for professional and high-reliability applications
- Alarm and safety equipment
- IR free air transmission

Typ Type	Bestellnummer Ordering Code	Strahlstärkegruppierung <sup>1)</sup> ( $I_F = 100\text{mA}$ , $t_p = 20\text{ ms}$ ) Radiant Intensity Grouping <sup>1)</sup> $I_e$ (mW/sr)
SFH 4209	Q65110A2501	24 (> 10)

<sup>1)</sup> gemessen bei einem Raumwinkel  $\Omega = 0.01$  / measured at a solid angle of  $\Omega = 0.01$  sr

Grenzwerte ( $T_A = 25\text{ °C}$ )

## Maximum Ratings

Bezeichnung Parameter	Symbol Symbol	Wert Value	Einheit Unit
Betriebs- und Lagertemperatur Operating and storage temperature range	$T_{op}; T_{stg}$	- 40 ...+ 100	°C
Sperrspannung Reverse voltage	$V_R$	3	V
Durchlaßstrom Forward current	$I_F$ (DC)	100	mA
Stoßstrom, $t_p = 10\text{ }\mu\text{s}$ , $D = 0$ Surge current	$I_{FSM}$	2.2	A
Verlustleistung Power dissipation	$P_{tot}$	180	mW
Wärmewiderstand Sperrschicht - Umgebung bei Montage auf FR4 Platine, Padgröße je $16\text{ mm}^2$ Thermal resistance junction - ambient mounted on PC-board (FR4), padsize $16\text{ mm}^2$ each	$R_{thJA}$	450	K/W
Wärmewiderstand Sperrschicht - Lötstelle bei Montage auf Metall-Block Thermal resistance junction - soldering point, mounted on metal block	$R_{thJS}$	200	K/W

Kennwerte ( $T_A = 25\text{ °C}$ )

## Characteristics

Bezeichnung Parameter	Symbol Symbol	Wert Value	Einheit Unit
Wellenlänge der Strahlung Wavelength at peak emission $I_F = 100\text{ mA}$ , $t_p = 20\text{ ms}$	$\lambda_{\text{peak}}$	950	nm
Spektrale Bandbreite bei 50% von $I_{\text{max}}$ Spectral bandwidth at 50% of $I_{\text{max}}$ $I_F = 100\text{ mA}$ , $t_p = 20\text{ ms}$	$\Delta\lambda$	40	nm
Abstrahlwinkel Half angle	$\varphi$	$\pm 25$	Grad deg.
Aktive Chipfläche Active chip area	$A$	0.09	mm <sup>2</sup>
Abmessungen der aktiven Chipfläche Dimensions of the active chip area	$L \times B$ $L \times W$	$0.3 \times 0.3$	mm
Schaltzeiten, $I_e$ von 10% auf 90% und von 90% auf 10%, bei $I_F = 100\text{ mA}$ , $t_p = 20\text{ ms}$ , $R_L = 50\ \Omega$ Switching times, $I_e$ from 10% to 90% and from 90% to 10%, $I_F = 100\text{ mA}$ , $t_p = 20\text{ ms}$ , $R_L = 50\ \Omega$	$t_r$ , $t_f$	10	ns
Durchlassspannung, Forward voltage $I_F = 100\text{ mA}$ , $t_p = 20\text{ ms}$ $I_F = 1\text{ A}$ , $t_p = 100\ \mu\text{s}$	$V_F$ $V_F$	1.5 ( $\leq 1.8$ ) 3.2 ( $\leq 4.3$ )	V V
Sperrstrom Reverse current $V_R = 3\text{ V}$	$I_R$	0.01 ( $\leq 10$ )	$\mu\text{A}$
Gesamtstrahlungsfluss Total radiant flux $I_F = 100\text{ mA}$ , $t_p = 20\text{ ms}$	$\Phi_e$	40	mW
Temperaturkoeffizient von $I_e$ bzw. $\Phi_e$ , $I_F = 100\text{ mA}$ Temperature coefficient of $I_e$ or $\Phi_e$ , $I_F = 100\text{ mA}$	$TC_I$	- 0.44	%/K
Temperaturkoeffizient von $V_F$ , $I_F = 100\text{ mA}$ Temperature coefficient of $V_F$ , $I_F = 100\text{ mA}$	$TC_V$	- 1.5	mV/K
Temperaturkoeffizient von $\lambda$ , $I_F = 100\text{ mA}$ Temperature coefficient of $\lambda$ , $I_F = 100\text{ mA}$	$TC_\lambda$	+ 0.2	nm/K

**Strahlstärke  $I_e$  in Achsrichtung<sup>1)</sup>**gemessen bei einem Raumwinkel  $\Omega = 0.01$  sr**Radiant Intensity  $I_e$  in Axial Direction**at a solid angle of  $\Omega = 0.01$  sr

Bezeichnung Parameter	Symbol	Werte Values			Einheit Unit
		SFH 4209-R	SFH 4209-S	SFH 4209-T	
Strahlstärke Radiant intensity $I_F = 100$ mA, $t_p = 20$ ms	$I_{e \text{ min}}$ $I_{e \text{ max}}$	10 20	16 32	25 50	mW/sr mW/sr
Strahlstärke Radiant intensity $I_F = 1$ A, $t_p = 100$ $\mu$ s	$I_{e \text{ typ.}}$	100	140	180	mW/sr

<sup>1)</sup> Nur eine Gruppe in einer Verpackungseinheit (Streuung kleiner 2:1)<sup>1)</sup> Only one group in one packing unit, (variation lower 2:1)

**Relative Spectral Emission**

$I_{rel} = f(\lambda)$

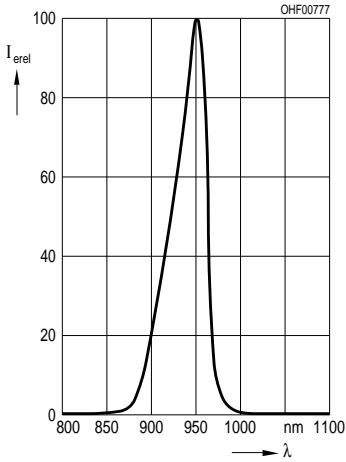

**Radiant Intensity**  $\frac{I_e}{I_e 100 \text{ mA}} = f(I_F)$

Single pulse,  $t_p = 20 \mu\text{s}$

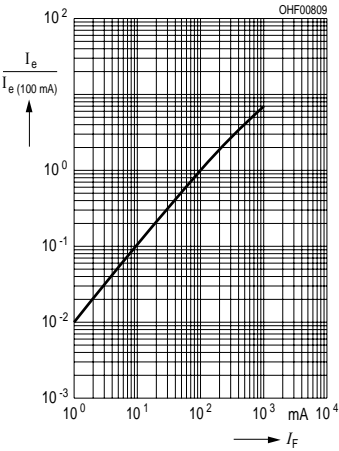

**Max. Permissible Forward Current**

$I_F = f(T_A, R_{thJA})^1$

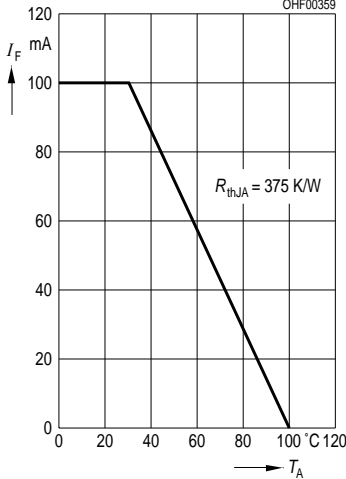

**Forward Current  $I_F = f(V_F)$**

single pulse,  $t_p = 20 \mu\text{s}$

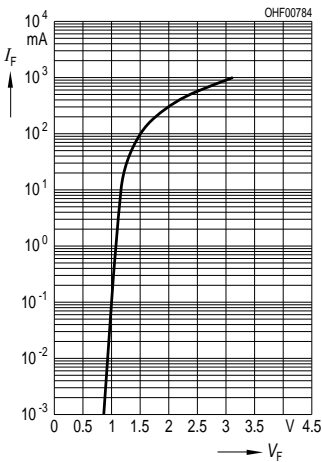

**Permissible Pulse Handling Capability**

$I_F = f(\tau, T_A = 25 \text{ }^\circ\text{C}, \text{duty cycle } D = \text{parameter})$

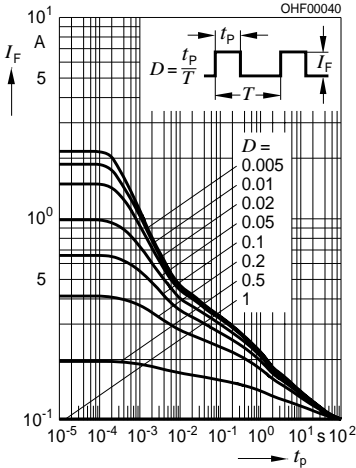

**Radiation Characteristics  $I_{rel} = f(\varphi)$**

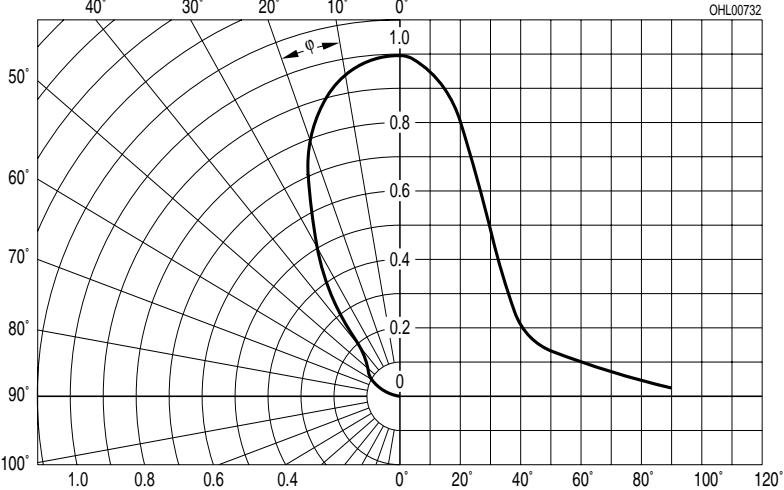

<sup>1)</sup> Thermal resistance junction - ambient mounted on PC-board (FR4), pad size 16 mm<sup>2</sup> (each).

## Maßzeichnung Package Outlines

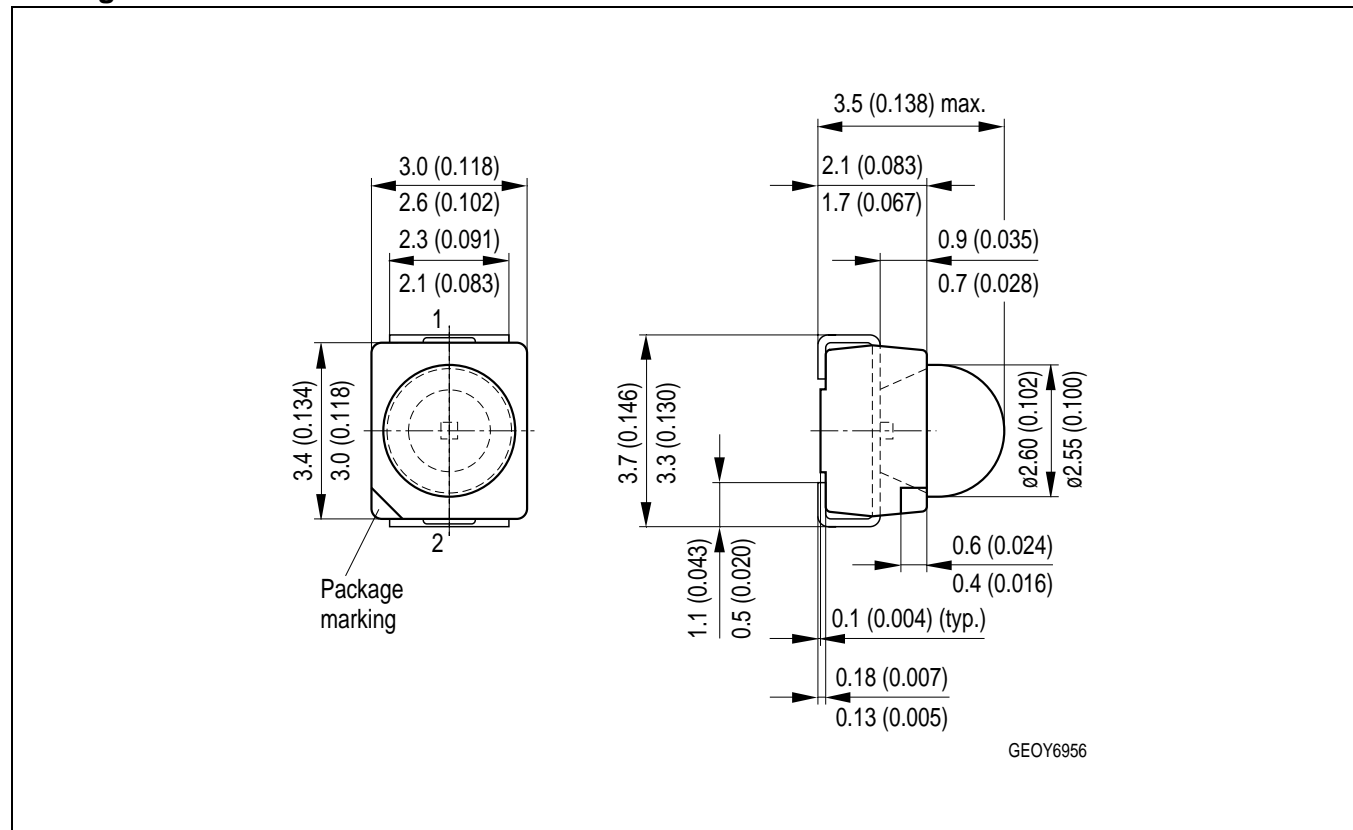

Maße werden wie folgt angegeben: mm (inch) / Dimensions are specified as follows: mm (inch).

Gehäuse / Package	TOPLED® mit Linse (P-LCC-2) / TOPLED® with lens (P-LCC-2)
Anschlussbelegung pin configuration	1 = Anode / anode 2 = Kathode / cathode
Farbe Color	weiß white

**Empfohlenes Lötpaddesign**  
**Recommended Solder Pad**

**IR-Reflow Löten**  
**IR Reflow Soldering**

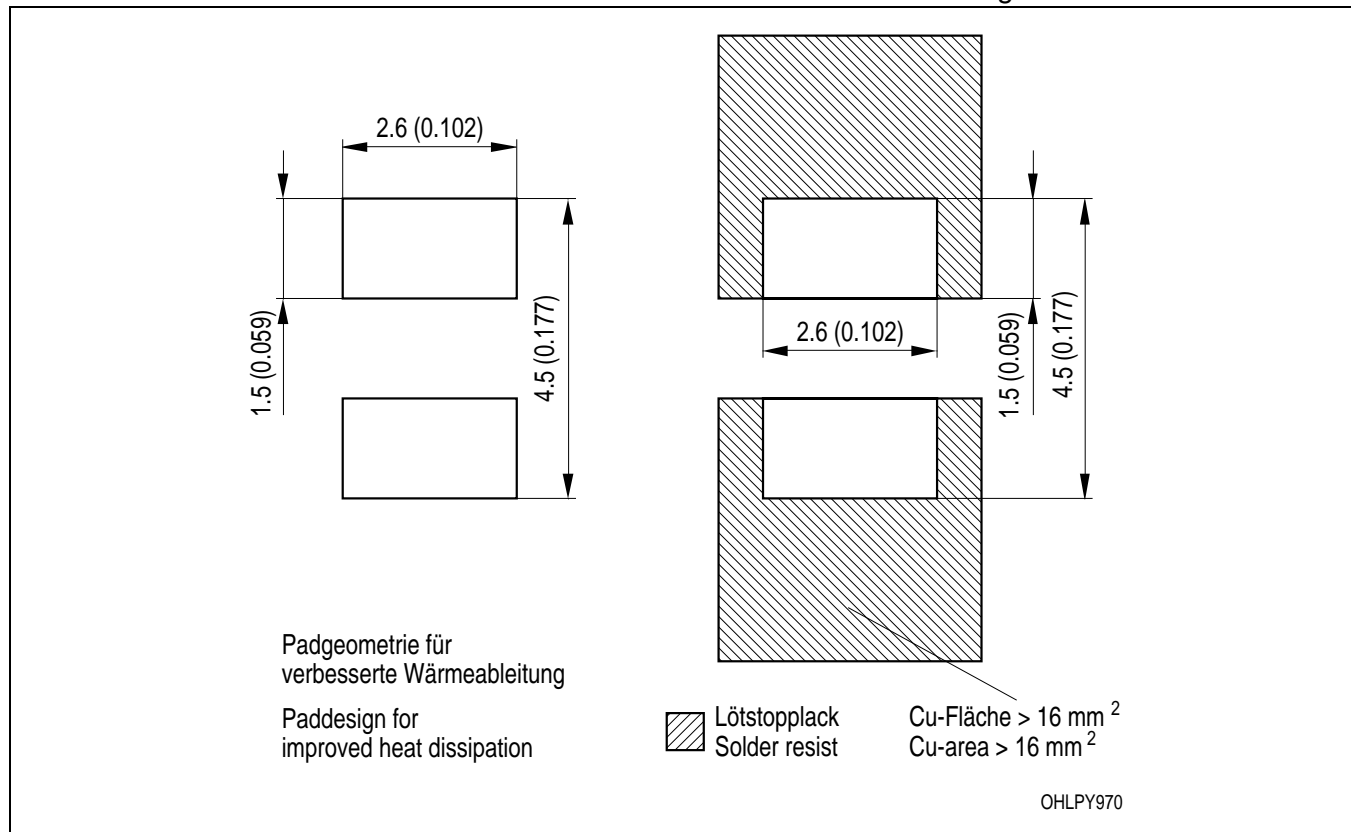

**Lötbedingungen**  
**Soldering Conditions**

**IR-Reflow Lötprofil für bleifreies Löt**  
**IR Reflow Soldering Profile for lead free soldering**

Vorbehandlung nach JEDEC Level 2  
 Preconditioning acc. to JEDEC Level 2  
 (nach J-STD-020B)  
 (acc. to J-STD-020B)

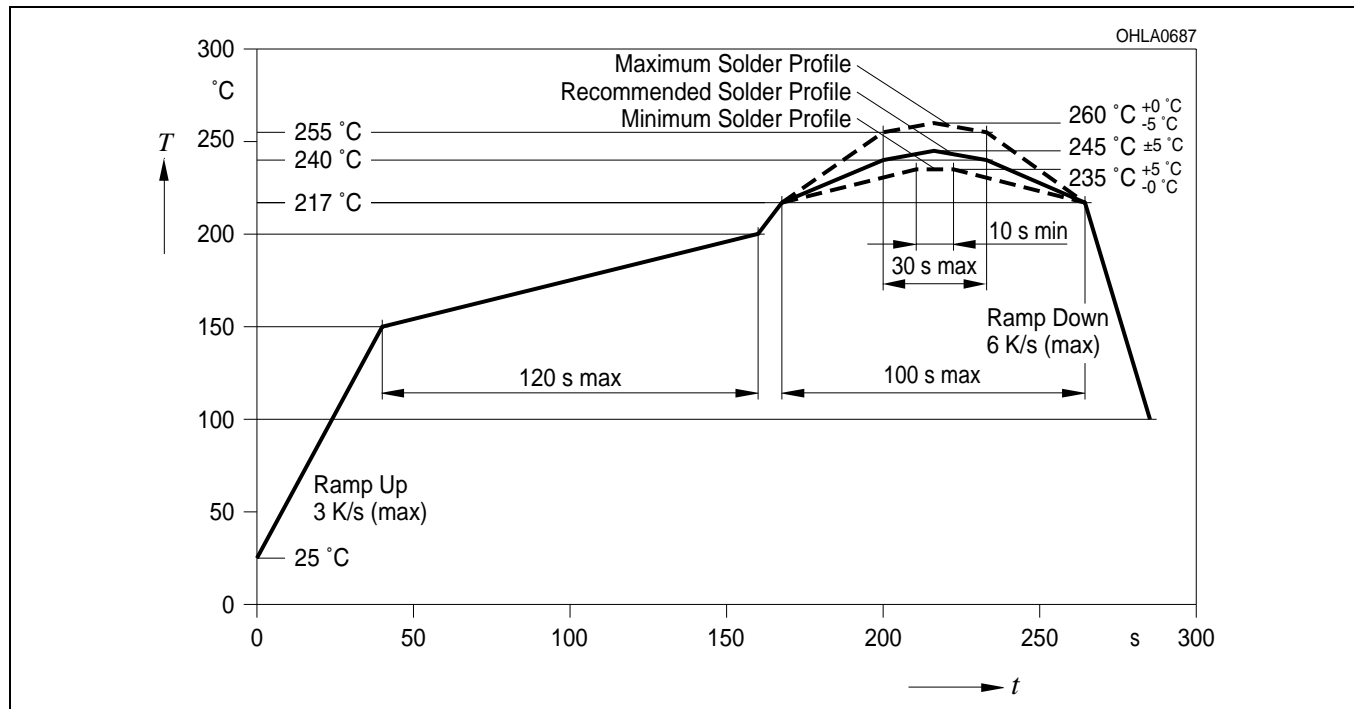

**Wellenlöt (TTW)**  
**TTW Soldering**

(nach CECC 00802)  
 (acc. to CECC 00802)

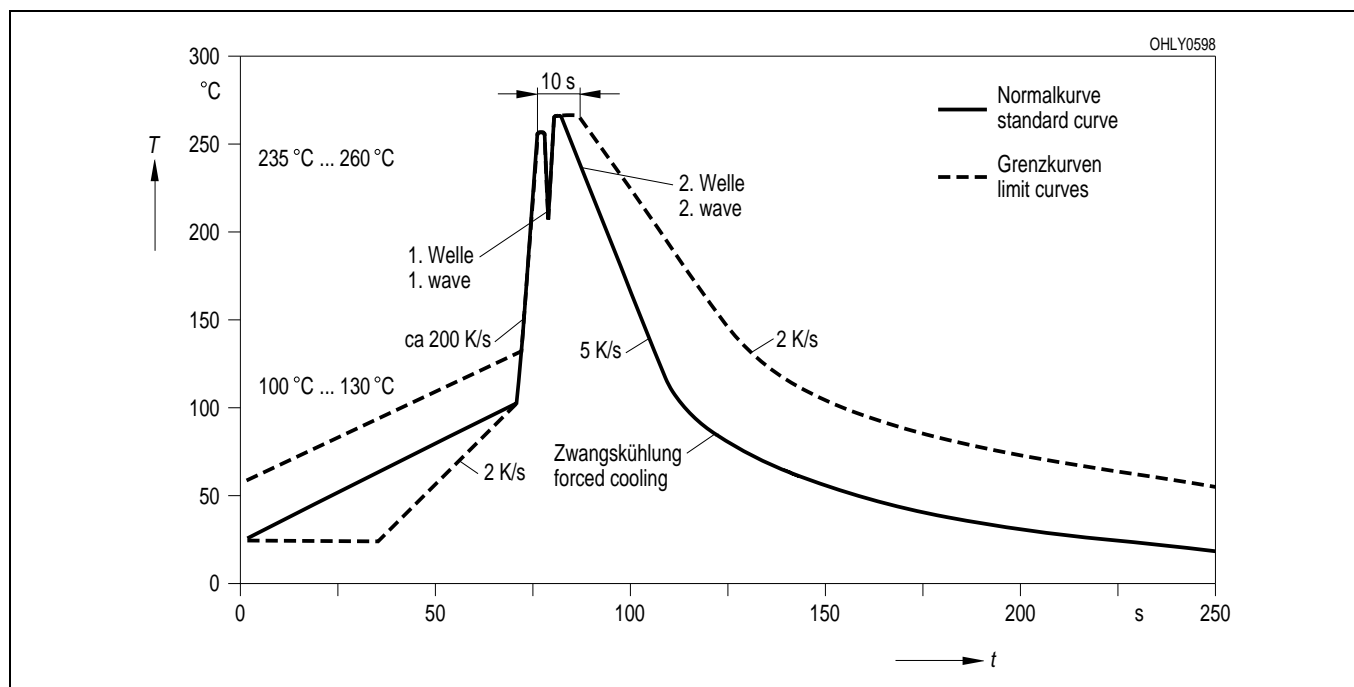



Published by  
**OSRAM Opto Semiconductors GmbH**  
Wernerwerkstrasse 2, D-93049 Regensburg  
[www.osram-os.com](http://www.osram-os.com)

© All Rights Reserved.

The information describes the type of component and shall not be considered as assured characteristics. Terms of delivery and rights to change design reserved. Due to technical requirements components may contain dangerous substances. For information on the types in question please contact our Sales Organization.

#### **Packing**

Please use the recycling operators known to you. We can also help you – get in touch with your nearest sales office. By agreement we will take packing material back, if it is sorted. You must bear the costs of transport. For packing material that is returned to us unsorted or which we are not obliged to accept, we shall have to invoice you for any costs incurred.

**Components used in life-support devices or systems must be expressly authorized for such purpose!** Critical components <sup>1</sup>, may only be used in life-support devices or systems <sup>2</sup> with the express written approval of OSRAM OS.

<sup>1</sup> A critical component is a component used in a life-support device or system whose failure can reasonably be expected to cause the failure of that life-support device or system, or to affect its safety or effectiveness of that device or system.

<sup>2</sup> Life support devices or systems are intended (a) to be implanted in the human body, or (b) to support and/or maintain and sustain human life. If they fail, it is reasonable to assume that the health of the user may be endangered.