



Better. By Design.

THREE-PHASE MONITOR RELAYS



CATALOG OF PRODUCTS

PRODUCT SUMMARY

Macromatic Three-Phase Monitor Relays provide protection against premature equipment failure caused by voltage faults on three-phase systems. They are designed to be compatible with most Wye or Delta systems with no connection to Neutral required. All Macromatic Series protect against single phasing regardless of any regenerative voltages except the PCP Series, which offers Phase Reversal protection only.

The Reference Guide below provides general information on the different versions of Three-Phase Monitor Relays offered by Macromatic (see Product Selection on the following pages for further details):



Series	Mounting Style	Phase Loss	Phase Reversal	Phase Unbalance	Under Voltage	Over Voltage	Time Delay on Undervoltage	Approvals ●
PCP	Plug-in ●		✓					cULus CE cULus
PLP	Plug-in ●	✓	✓					
PAP	Plug-in ●	✓	✓		✓ (adj.)		4 seconds fixed	
PJP	Plug-in ●	✓	✓	Indication only	✓ (fixed)		4 seconds fixed	
PMP	Plug-in ●	✓	✓	✓ (adj.)	✓ (adj.)	✓ (fixed)	0.1 - 30 sec.	
PMP-FA	Plug-in ●	✓	✓	✓ (fixed)	✓ (fixed)	✓ (fixed)	4 seconds fixed	
PMD	DIN-Rail	✓	✓	✓ (adj.)	✓ (adj.)	✓ (fixed)	0.1 - 30 sec.	cULus CE
PBDU	DIN-Rail	✓	✓	✓ (adj.)				cULus CE

● All Plug-in Products are cULus Listed when used with the appropriate Macromatic socket.

PROTECTION

Depending on the unit selected, it will protect three-phase equipment against:

- ◆ **Phase loss** - total loss of one or more of the three phases. Also known as “single phasing.” Typically caused by a blown fuse, broken wire, or worn contact. This condition would result in a motor drawing locked rotor current during start-up. In addition, a three-phase motor will continue to run after losing a phase, resulting in possible motor burn-out.
- ◆ **Phase reversal** - reversing any two of the three phases will cause a three-phase motor to run in the opposite direction. This may cause damage to driven machinery or injury to personnel. The condition usually occurs as a result of mistakes made during routine maintenance or when modifications are made to the circuit.
- ◆ **Phase unbalance** - unbalance of a three-phase system occurs when single phase loads are connected such that one or two of the lines (phases) carry more or less of the load. This could cause motors to run at temperatures above published ratings.
- ◆ **Undervoltage** - when voltage in all three lines of a three-phase system drop simultaneously. This could result in an increase in current and motor heating and a reduction in motor performance.
- ◆ **Overvoltage** - when voltage in all three lines of a three-phase system increase simultaneously. Could cause a decrease in load current and poor power factor.

TYPICAL CONNECTIONS

Line Side Monitoring

With the relay connected before the motor starter, the motor can be started in the reverse direction. However, the motor is unprotected against phase failures between the relay and the motor.

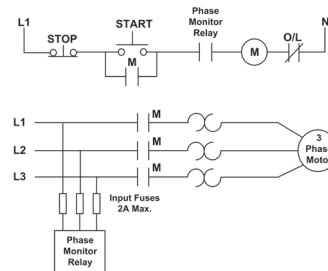

Load Side Monitoring

With the relay connected directly to the motor, the total feed lines are monitored. However, this connection should not be used with reversing motors.

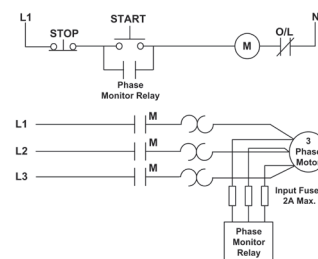

PHASE REVERSAL

PCP SERIES

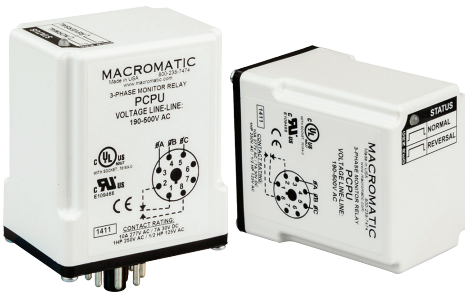

- ◆ Protects against phase reversal only
- ◆ Universal voltage range of 190-500V or 460-600V—greater range that covers more global applications
- ◆ Full fault indication on top of unit for easy troubleshooting
- ◆ 10A SPDT output contacts



The PCP Series Three-Phase Monitor Relays continuously monitor all voltages to protect motors and equipment from expensive damage due to phase reversal. These products have an isolated relay output that is only energized if the three phases are in the proper A-B-C sequence. The relay output will remain open if any two phases are reversed.

Phase Reversal Relays should be used in applications where motor direction is critical or sequence detection is required by Code. **NOTE:** these products provide protection against phase reversal only. If a product with more than phase reversal protection is required, see the Reference Guide at the beginning of this catalog section to select the correct product.

The PCP Series is a true universal product, with two units that work on a wide variety of line-line voltages without any adjustment to cover more global applications. They utilize an industry-standard 8 pin octal socket.

Operation:

When the proper three-phase line voltage is applied to the unit and the phase sequence (rotation) is correct, the relay is energized after the Restart Delay is completed. An out-of-sequence condition will prevent the relay from energizing on start-up or de-energize the relay after a delay if it occurs when energized. Re-energization is automatic upon correction of the fault condition. A bi-color status LED indicates normal condition and also provides specific fault indication to simplify troubleshooting.

PCP SERIES

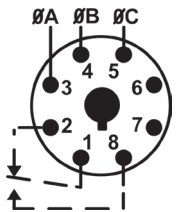
PROTECTS AGAINST	LINE-LINE VOLTAGE▲ (50/60 Hz)	CATALOG NUMBER	WIRING/SOCKET
Phase Reversal	190-500V 460-600V	PCPU ● PCP575 ●	8 Pin Octal 70169-D ØA ØB ØC  DIAGRAM 23

- ▲ Phase-to-Phase (Line-to-Line).
- Requires a 600V-rated socket when used on system voltages above 300V.



Better. By Design.

800.238.7474
WWW.MACROMATIC.COM
SALES@MACROMATIC.COM

Sockets & Accessories available

PHASE REVERSAL

PCP SERIES

APPLICATION DATA

Voltage Requirements:

RANGE (50/60Hz ±5%)	MIN VOLTAGE	MAX VOLTAGE	CATALOG NUMBER
190-500V AC	156V AC	550V AC	PCPU
460-600V AC	390V AC	660V AC	PCP575

Power Consumption: Less than 40VA

Phase Reversal (Sequence):

Unit trips if rotation (sequence) of the three phases is anything other than A-B-C. It will not work on C-B-A.

Response Times:

Power Up & Restart After Fault: 1 second fixed

Drop-out Due to Phase Reversal: 100ms fixed



Output Contacts: SPDT 10 A @ 277V AC / 7A @ 30V DC;
1HP @ 250V AC, 1/2HP @ 125V AC,
C300 Pilot Duty

Life: Mechanical: 10,000,000 operations; Full Load: 100,000 operations

Temperature: Operating: -28° to 65°C (-18° to 149°F)
Storage: -40° to 85°C (-40° to 185°F)

Mounting: Uses an 8 pin octal socket. Requires a 600V-rated socket when used on system voltages greater than 300V such as Macromatic Catalog Number 70169-D.

Status LED:

	LED STATUS	STATUS
GRN		NORMAL/ RELAY ON
RED		REVERSAL

Reset:

Automatic upon correction of fault.

Approvals:

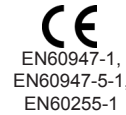

DIMENSIONS

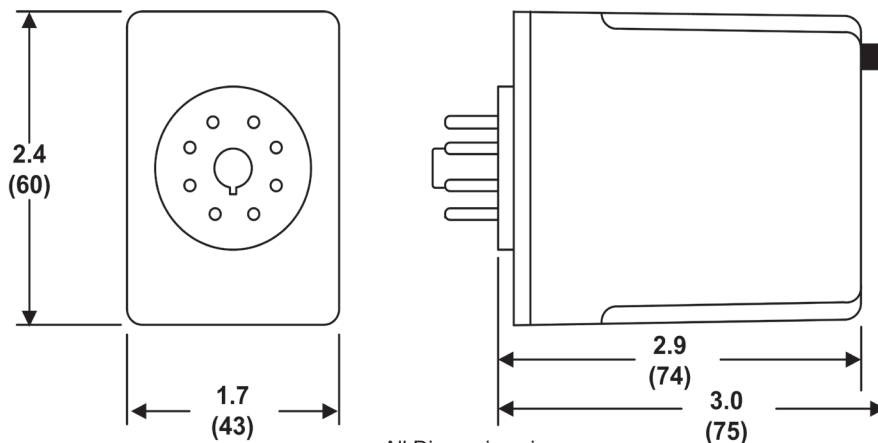

All Dimensions in
Inches (Millimeters)

PHASE LOSS & REVERSAL

PLP SERIES

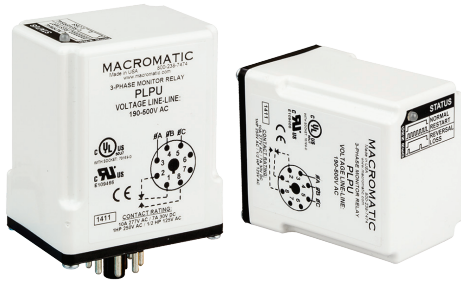

- ◆ Protects against phase loss & phase reversal
- ◆ Universal voltage range of 190-500V or 460-600V—greater range that covers more global applications
- ◆ True RMS voltage measurement ensures accurate sensing across more applications
- ◆ Retains fault indication & continues to monitor voltages even with lost phase
- ◆ Full fault indication on top of unit for easy troubleshooting
- ◆ 10A SPDT output contacts

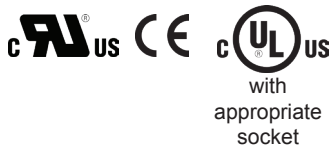

THREE-PHASE MONITOR RELAYS | PLUG-IN



Better. By Design.

800.238.7474
WWW.MACROMATIC.COM
SALES@MACROMATIC.COM

The PLP Series Three-Phase Monitor Relays continuously monitor all voltages to protect motors and equipment from expensive damage due to phase loss and phase reversal. These products detect single phasing regardless of any regenerative voltages.

Utilizing an advanced microprocessor-based design allows true RMS voltage measurement with full wave monitoring. This provides a more accurate method to measure the voltages, regardless of load type or wave shape, and results in improved protection across more applications.

True RMS voltage measurement ensures accurate sensing in most generator and other applications with non-sinusoidal wave forms, eliminating nuisance tripping. Full wave monitoring provides a more accurate method to measure the voltages, regardless of load type or wave shape, resulting in improved protection across more applications.

Unlike similar three-phase monitor relays, the PLP Series will continue to function even with a lost phase. They are the only line-powered units in their class to retain fault indication and continuous monitoring of all voltages during a phase loss, increasing the ease of troubleshooting and the level of protection.

The PLP Series is a true universal product, with two units that work on a wide variety of line-line voltages without any adjustment to cover more global applications. They utilize an industry-standard 8 pin octal socket.

Operation:

When the proper three-phase line voltage is applied to the unit and the phase sequence (rotation) is correct, the relay is energized after the Restart Delay is completed. A phase loss or phase reversal condition will de-energize the relay after a delay. Re-energization is automatic upon correction of the fault condition. A bi-color status LED indicates normal condition and also provides specific fault indication to simplify troubleshooting.

PLP SERIES

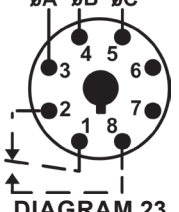
PROTECTS AGAINST	LINE-LINE VOLTAGE▲ (50/60 Hz)	CATALOG NUMBER	WIRING/SOCKET
Phase Reversal & Phase Loss	190-500V	PLPU ●	8 Pin Octal 70169-D ØA ØB ØC  DIAGRAM 23
	460-600V	PLP575 ●	

- ▲ Phase-to-Phase (Line-to-Line).
- Requires a 600V-rated socket when used on system voltages above 300V.

Sockets & Accessories available

PHASE LOSS & REVERSAL

PLP SERIES

APPLICATION DATA

Voltage Requirements:

RANGE (50/60HZ ±5%)	MIN VOLTAGE	MAX VOLTAGE	CATALOG NUMBER
190-500V AC	156V AC	550V AC	PLPU
460-600V AC	390V AC	660V AC	PLP575

Power Consumption: Less than 40VA.

Phase Loss:

Unit trips on loss of any Phase A, B or C, regardless of any regenerative voltages.

Phase Reversal (Out-of-Sequence):

Unit trips if sequence (rotation) of the three phases is anything other than A-B-C. It will not work on C-B-A.

Response Times:

Restart: 1 second fixed
 Drop-out Due to Fault:
 Phase Loss and Reversal: 100ms fixed

Output Contacts: SPDT 10 A @ 277V AC / 7A @ 30V DC;
 1HP @ 250V AC, 1/2HP @ 125V AC,
 C300 Pilot Duty

Life: Mechanical: 10,000,000 operations; Full Load: 100,000 operations

Temperature: Operating: -28° to 65°C (-18° to 149°F)
 Storage: -40° to 85°C (-40° to 185°F)

Mounting: Uses an 8 pin octal socket. Requires a 600V-rated socket when used on system voltages greater than 300V such as Macromatic Catalog Number 70169-D.

Status LED:

	LED STATUS	STATUS
GREEN		NORMAL (RELAY ON)
		RESTART (DELAY)
RED		REVERSAL
		LOSS

Reset:

Automatic upon correction of fault.

Approvals:

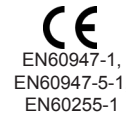

DIMENSIONS

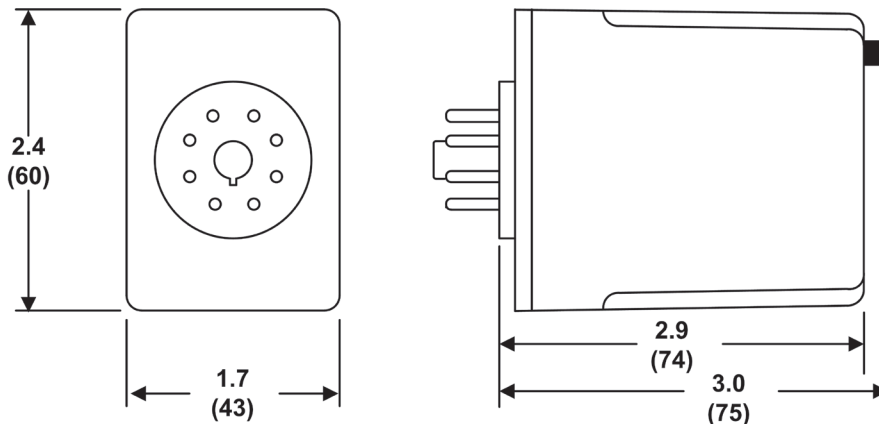

All Dimensions in Inches (Millimeters)

PHASE LOSS, PHASE REVERSAL & UNDERVOLTAGE

PAP SERIES

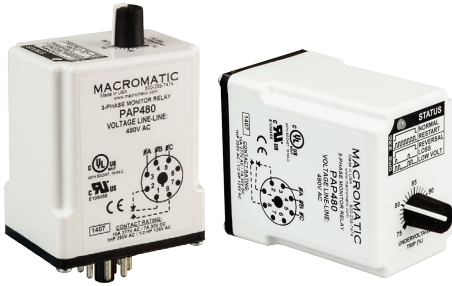

- ◆ Protects against phase loss, phase reversal & undervoltage
- ◆ True RMS voltage measurement ensures accurate sensing across more applications
- ◆ Retains fault indication and continues monitoring all voltages even with a lost phase
- ◆ Full fault indication on top of unit for easy troubleshooting
- ◆ 10A SPDT output contacts

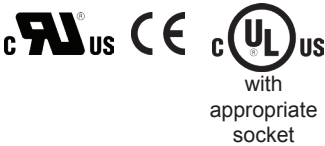

The PAP Series Three-Phase Monitor Relays continuously monitor all voltages to protect motors and equipment from expensive damage due to phase loss, phase reversal and undervoltage. These products detect single phasing and unbalanced voltages regardless of any regenerative voltages.

Utilizing an advanced microprocessor-based design allows true RMS voltage measurement with full wave monitoring. This provides a more accurate method to measure the voltages, regardless of load type or wave shape, and results in improved protection across more applications.

True RMS voltage measurement ensures accurate sensing in most generator and other applications with non-sinusoidal wave forms, eliminating nuisance tripping. Full wave monitoring provides a more accurate method to measure the voltages, regardless of load type or wave shape, resulting in improved protection across more applications.

Unlike similar three-phase monitor relays, the PAP Series will continue to function even with a lost phase. They are the only line-powered units in their class to retain fault indication and continuous monitoring of all voltages during a phase loss, increasing the ease of troubleshooting and the level of protection.

The PAP Series have an adjustable undervoltage trip point of 75-95% of the line-line voltage setting. They utilize an industry-standard 8 pin octal socket.

Operation:

When the proper three-phase line voltage is applied to the unit and the phase sequence (rotation) is correct, the relay is energized after the Restart Delay is completed. Any one of three fault conditions will de-energize the relay after a delay. Re-energization is automatic upon correction of the fault condition. A bi-color status LED indicates normal condition and also provides specific fault indication to simplify troubleshooting.

PAP SERIES

PROTECTS AGAINST	LINE-LINE VOLTAGE▲ 50/60 Hz	UNDER-VOLTAGE RANGE	CATALOG NUMBER	WIRING/ SOCKET
Phase Loss, Phase Reversal, & Undervoltage	208V	156-198V	PAP208	8 Pin Octal 70169-D
	240V	180-230V	PAP240	
	400V	300-380V	PAP400 ●	
	480V	360-460V	PAP480 ●	
	575V	431-546V	PAP575 ●	

DIAGRAM 23

- ▲ Phase-to-Phase (Line-to-Line).
- Requires a 600V-rated socket when used on system voltages above 300V.

Sockets & Accessories available



Better. By Design.

800.238.7474

WWW.MACROMATIC.COM

SALES@MACROMATIC.COM

PHASE LOSS, PHASE REVERSAL & UNDERVOLTAGE

PAP SERIES

APPLICATION DATA

Voltage Requirements:

RANGE (50/60HZ ±5%)	MIN VOLTAGE	MAX VOLTAGE	CATALOG NUMBER
156-198V AC	156V AC	550V AC	PAP208
180-230V AC	156V AC	550V AC	PAP240
330-380V AC	156V AC	550V AC	PAP400
360-460V AC	156V AC	550V AC	PAP480
431-546V AC	390V AC	660V AC	PAP575

Power Consumption: Less than 40VA

Phase Loss:

Unit trips on loss of any Phase A, B or C, regardless of any regenerative voltages.

Phase Reversal (Out-of-Sequence):

Unit trips if sequence (rotation) of the three phases is anything other than A-B-C. It will not work on C-B-A.

Undervoltage:

Adjustable from 75-95% of the line voltage setting. Unit trips when the average of all three lines is less than the adjusted set point for a period longer than the adjustable trip delay. It will reset at +3% of the Undervoltage trip setting.

Response Times:

Restart: 1 second fixed
 Drop-out Due to Fault:
 Phase Loss and Reversal: 100ms fixed
 Undervoltage: 4 seconds fixed

Output Contacts: SPDT 10 A @ 277V AC / 7A @ 30V DC;
 1HP @ 250V AC, 1/2HP @ 125V AC,
 C300 Pilot Duty

Life: Mechanical: 10,000,000 operations; Full Load: 100,000 operations

Temperature: Operating: -28° to 65°C (-18° to 149°F)
 Storage: -40° to 85°C (-40° to 185°F)

Mounting: Uses an 8 pin octal socket. Requires a 600V-rated socket when used on system voltages greater than 300V such as Macromatic Catalog Number 70169-D.

Status LED:

	LED STATUS	STATUS
GREEN		NORMAL (RELAY ON)
		RESTART (DELAY)
RED		REVERSAL
		LOSS
		LOW VOLT (UNDERVOLTAGE)

Reset:

Automatic upon correction of fault.

Approvals:

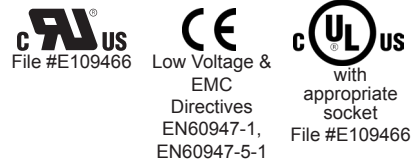

DIMENSIONS

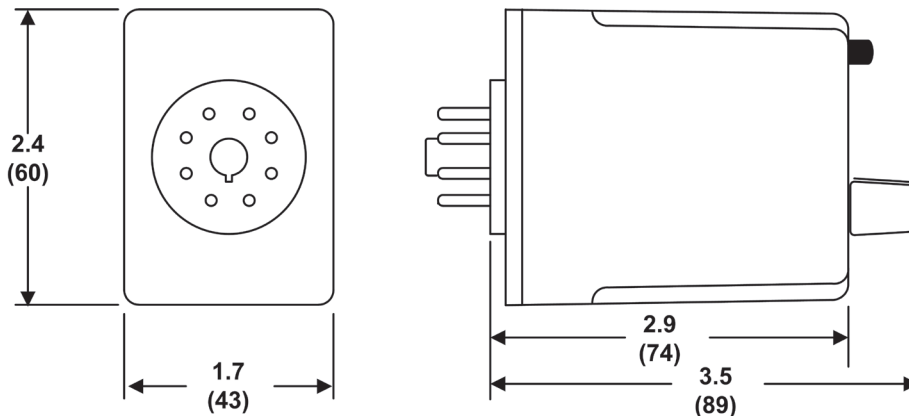

All Dimensions in
 Inches (Millimeters)

PHASE LOSS, PHASE REVERSAL & UNDERVOLTAGE

PJPU-FA8X SERIES

THREE-PHASE MONITOR RELAYS | PLUG-IN

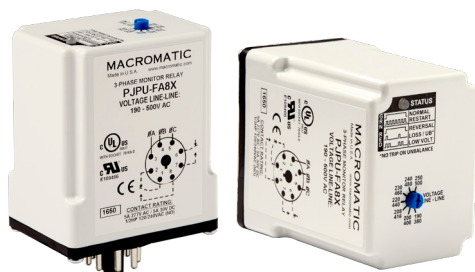

- ◆ Protects against phase loss, phase reversal, undervoltage & rapid cycling
- ◆ Indication of Phase Unbalance (Relay Does Not Trip)
- ◆ Universal voltage range of 190-500V—greater range that covers more global applications
- ◆ True RMS voltage measurement ensures accurate sensing across more applications
- ◆ Retains fault indication and continues monitoring all voltages even with a lost phase
- ◆ Full fault indication on top of unit for easy troubleshooting
- ◆ 5A SPDT/SPNO output provides isolated contact for alarm circuits



Better. By Design.

800.238.7474

WWW.MACROMATIC.COM

SALES@MACROMATIC.COM

The PJPU-FA8X Series Three-Phase Monitor Relays continuously monitor all voltages to protect motors and equipment from expensive damage due to phase loss, phase reversal & undervoltage. They also provide an indication of a phase unbalance condition, but the relay does not trip. These products detect single phasing and unbalanced voltages regardless of any regenerative voltages.

Utilizing an advanced microprocessor-based design allows true RMS voltage measurement with full wave monitoring. This provides a more accurate method to measure the voltages, regardless of load type or wave shape, and results in improved protection across more applications.

True RMS voltage measurement ensures accurate sensing in most generator and other applications with non-sinusoidal wave forms, eliminating nuisance tripping. Full wave monitoring provides a more accurate method to measure the voltages, regardless of load type or wave shape, resulting in improved protection across more applications.

Unlike similar three-phase monitor relays, the PJPU-FA8X Series will continue to function even with a lost phase. They are the only line-powered units in their class to retain fault indication and continuous monitoring of all voltages during a phase loss, increasing the ease of troubleshooting and the level of protection.

The PJPU-FA8X Series is a true universal product that works on a wide variety of adjustable line-line voltages to cover more global applications. All other settings for undervoltage trip point, trip delay, restart delay and unbalance trip point are fixed for ease of setup. In addition to the standard SPDT output contacts, these products include an extra SPNO contact that provides an isolated output for alarm circuits. They utilize an industry-standard 8 pin octal socket, even with the extra SPNO output (see www.macromatic.com/fa8x).

Operation:

When the proper three-phase line voltage is applied to the unit and the phase sequence (rotation) is correct, the relay is energized after the Restart Delay is completed. A fault condition of phase loss, phase reversal or undervoltage will de-energize the relay after a delay. Re-energization of the relay is automatic upon correction of the fault condition. NOTE: the relay will not trip (de-energize) on an unbalance condition, but the LED will provide a visual indication at 6% unbalance until correction of the fault condition. A bi-color status LED indicates normal condition and also provides specific fault indication to simplify troubleshooting.

PJPU-FA8X Series

PROTECTS AGAINST	LINE-LINE VOLTAGE▲ 50/60 Hz	CATALOG NUMBER	WIRING/SOCKET
Phase Loss, Phase Reversal & Undervoltage (Unbalance Indication Only)	190-500V	PJPU-FA8X ● ■	8 Pin Octal 70169-D DIAGRAM 175

- ▲ Phase-to-Phase (Line-to-Line).
- Requires a 600V-rated socket when used on system voltages above 300V.
- Dual range unit auto-senses between the 190-250V AC and 350-500V AC ranges (see Application Data on next page).

Sockets & Accessories available

PHASE LOSS, PHASE REVERSAL & UNDERVOLTAGE

PJPU-FA8X SERIES

APPLICATION DATA

Voltage Requirements:

RANGE (50/60Hz ±5%)	MIN VOLTAGE	MAX VOLTAGE	CATALOG NUMBER
190-500V AC	156V AC	550V AC	PJPU-FA8X

Three-Phase Line-Line Voltage:

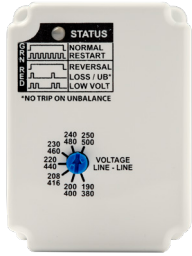

The Voltage Line-Line knob on the PJPU-FA8X has two ranges (left): a 190-250V low voltage scale and a 350-500V high voltage scale. The unit auto senses the three-phase line-line voltage when applied and automatically selects the appropriate range.

Power Consumption: Less than 40VA.

Phase Loss: Unit trips on loss of any Phase A, B or C, regardless of any regenerative voltages.

Phase Reversal (Out-of-Sequence): Unit trips if sequence (rotation) of the three phases is anything other than A-B-C. It will not work on C-B-A.

Undervoltage: Fixed at 90% of the line voltage setting. Unit trips when the average of all three lines is less than the set point for a period longer than the fixed 4 second trip delay. It will reset at +3% of the Undervoltage trip setting.

Phase Unbalance: Fixed at 6% unbalance. The relay will not trip (de-energize) on an unbalance condition, but the LED will provide a visual indication at 6% unbalance until correction of fault.

Response Times:

Restart:	2 seconds fixed
Drop-out Due to Fault:	
Phase Loss and Reversal:	100ms fixed
Undervoltage:	4 seconds fixed

Output Contacts: SPDT/SPNO 5 A @ 277V AC / 5A @ 30V DC;
1HP @ 250V AC, 1/2HP @ 125V AC,
C300 Pilot Duty

Life: Mechanical: 10,000,000 operations; Full Load: 100,000 operations

Temperature: Operating: -28° to 65°C (-18° to 149°F)
Storage: -40° to 85°C (-40° to 185°F)

Mounting: Uses an 8 pin octal socket. Requires a 600V-rated socket when used on system voltages greater than 300V such as Macromatic Catalog Number 70169-D.

Status LED:

	LED STATUS	STATUS
GREEN	[High Level]	NORMAL (RELAY ON)
	[Pulsing]	RESTART (DELAY)
RED	[High Level]	REVERSAL
	[Pulsing]	LOSS/UB* (UNBALANCE)
	[Pulsing]	LOW VOLT (UNDERVOLTAGE)

Reset: Automatic upon correction of fault.

Approvals:



DIMENSIONS

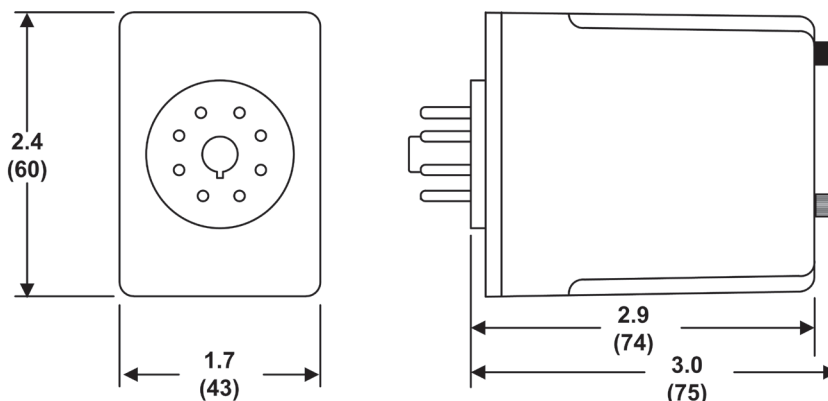

All Dimensions in Inches (Millimeters)

PHASE LOSS, PHASE REVERSAL, PHASE UNBALANCE, UNDERVOLTAGE & OVERVOLTAGE

PMP SERIES



- ◆ Protects against phase loss, phase reversal, phase unbalance, undervoltage, overvoltage & rapid cycling
- ◆ Wide voltage ranges to cover more global applications
- ◆ True RMS voltage measurement ensures accurate sensing across more applications
- ◆ Retains fault indication and continues monitoring all voltages even with a lost phase
- ◆ Full fault indication on top of unit for easy troubleshooting
- ◆ Manual reset option works with external switch to reset the relay from outside the enclosure
- ◆ 10A SPDT output contacts



Better. By Design.

800.238.7474

WWW.MACROMATIC.COM

SALES@MACROMATIC.COM

The PMP Series Three-Phase Monitor Relays continuously monitor all voltages to protect motors and equipment from expensive damage due to phase loss, phase reversal, phase unbalance, undervoltage and overvoltage. These products detect single phasing and unbalanced voltages regardless of any regenerative voltages.

Utilizing an advanced microprocessor-based design allows true RMS voltage measurement with full wave monitoring. This provides a more accurate method to measure the voltages, regardless of load type or wave shape, and results in improved protection across more applications.

True RMS voltage measurement ensures accurate sensing in most generator and other applications with non-sinusoidal wave forms, eliminating nuisance tripping. Full wave monitoring provides a more accurate method to measure the voltages, regardless of load type or wave shape, resulting in improved protection across more applications.

Unlike similar three-phase monitor relays, the PMP Series will continue to function even with a lost phase. They are the only line-powered units in their class to retain fault indication and continuous monitoring of all voltages during a phase loss, increasing the ease of troubleshooting and the level of protection.

The PMP Series is a true universal product, with three units that work on a wide variety of adjustable line-line voltages to cover more global applications. Additional knobs allow adjustment of the undervoltage trip point, trip delay, restart delay and unbalance trip point. They utilize an industry-standard 8 pin octal socket.

Operation:

When the proper three-phase line voltage is applied to the unit and the phase sequence (rotation) is correct, the relay is energized after the Restart Delay is completed. Any one of five fault conditions will de-energize the relay after a delay. As standard, re-energization is automatic upon correction of the fault condition. Manual reset is available if an external momentary N.C. switch is connected to pins 6 and 7. A bi-color status LED indicates normal condition and also provides specific fault indication to simplify troubleshooting.

PMP Series

PROTECTS AGAINST	LINE-LINE VOLTAGE ▲ 50/60 Hz	CATALOG NUMBER	WIRING/SOCKET
Phase Loss, Phase Reversal, Phase Unbalance, Undervoltage & Overvoltage	102-138V	PMP120	8 Pin Octal 70169-D DIAGRAM 104
	190-500V	PMPU ● ■	
	460-600V	PMP575 ●	

- ▲ Phase-to-Phase (Line-to-Line).
- Requires a 600V-rated socket when used on system voltages above 300V.
- Dual range unit auto-senses between the 190-250V AC and 350-500V AC ranges (see Application Data on next page).

Sockets & Accessories available

PHASE LOSS, PHASE REVERSAL, PHASE UNBALANCE, UNDERVOLTAGE & OVERVOLTAGE

PMP SERIES

APPLICATION DATA

Voltage Requirements:

RANGE (50/60Hz ±5%)	MIN VOLTAGE	MAX VOLTAGE	CATALOG NUMBER
190-500V AC	156V AC	550V AC	PMPU
102-138V AC	77V AC	152V AC	PMP120
460-600V AC	345V AC	660V AC	PMP575

Three-Phase Line-Line Voltage:

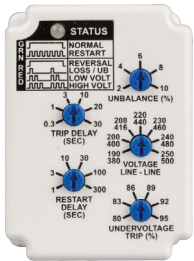

The Voltage Line-Line knob on the PMPU has two ranges (left): a 190-250V low voltage scale and a 380-500V high voltage scale. The unit auto senses the three-phase line-line voltage when applied and automatically selects the appropriate range.

The PMP120 has a single adjustable range of 102-138V and the PMP575 has a single adjustable range of 460-600V.

Power Consumption: Less than 40VA.

Phase Loss: Unit trips on loss of any Phase A, B or C, regardless of any regenerative voltages.

Phase Reversal (Out-of-Sequence): Unit trips if sequence (rotation) of the three phases is anything other than A-B-C. It will not work on C-B-A.

Undervoltage: Adjustable from 80-95% of the line voltage setting. Unit trips when the average of all three lines is less than the adjusted set point for a period longer than the adjustable trip delay. It will reset at +3% of the Undervoltage trip setting.

Overvoltage: Fixed at 110% of the line voltage setting. Unit trips when the average of all three lines is greater than the fixed set point for a period longer than the adjustable trip delay. It will reset at 107% of the line voltage setting.

Phase Unbalance: Adjustable from 2-10% unbalance. Unit trips when any one of the three lines deviates from the average of all three lines by more than the adjusted set point for a period longer than the adjustable trip delay.

Response Times:

Restart:	1 - 300 seconds adjustable
Drop-out Due to Fault:	
Phase Loss and Reversal:	100ms fixed
Undervoltage and Overvoltage:	0.3 - 30 seconds adjustable
Unbalance:	
Normal:	0.3 - 30 seconds adjustable
Severe (Twice Knob Setting):	0.3 - 2 seconds

Output Contacts: SPDT 10 A @ 277V AC / 7A @ 30V DC;
1HP @ 250V AC, 1/2HP @ 125V AC,
C300 Pilot Duty

Life: Mechanical: 10,000,000 operations; Full Load: 100,000 operations

Temperature: Operating: -28° to 65°C (-18° to 149°F)
Storage: -40° to 85°C (-40° to 185°F)

Mounting: Uses an 8 pin octal socket. Requires a 600V-rated socket when used on system voltages greater than 300V such as Macromatic Catalog Number 70169-D.

Status LED:

	LED STATUS	STATUS
GREEN		NORMAL (RELAY ON)
		RESTART (DELAY)
RED		REVERSAL
		LOSS/UB (UNBALANCE)
		LOW VOLT (UNDERVOLTAGE)
		HIGH VOLT (OVERVOLTAGE)

Reset: As standard, the PMP Series relays are in the Automatic Reset mode. However, they can be set in the Manual Reset mode by connecting an external N.C. switch across terminals 6 and 7. Upon application of line voltage, the PMP Series will go into Manual Reset mode if it recognizes a closure across terminals 6 and 7. After a fault clears, the relay will not reset until the N.C. switch is opened.
Note: When the unit is in the Manual Reset mode, the N.C. switch must be opened after each Power-up to reset the relay and resume normal operation.

Approvals:



DIMENSIONS

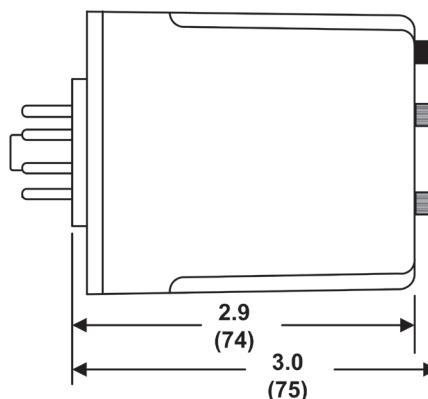
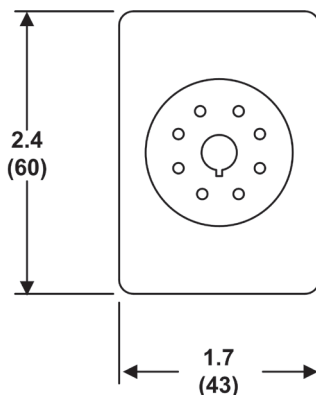

All Dimensions in Inches (Millimeters)

PHASE LOSS, PHASE REVERSAL, PHASE UNBALANCE, UNDERVOLTAGE & OVERVOLTAGE

PMPU-FA8 SERIES

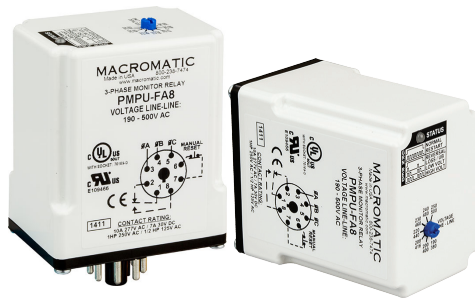

- ◆ Protects against phase loss, phase reversal, phase unbalance, undervoltage, overvoltage & rapid cycling
- ◆ Universal voltage range of 190-500V—greater range that covers more global applications
- ◆ True RMS voltage measurement ensures accurate sensing across more applications
- ◆ Retains fault indication and continues monitoring all voltages even with a lost phase
- ◆ Full fault indication on top of unit for easy troubleshooting
- ◆ Manual reset option works with external switch to reset the relay from outside the enclosure
- ◆ 10A SPDT output contacts



Better. By Design.

800.238.7474

WWW.MACROMATIC.COM

SALES@MACROMATIC.COM

The PMPU-FA8 Series Three-Phase Monitor Relays continuously monitor all voltages to protect motors and equipment from expensive damage due to phase loss, phase reversal, phase unbalance, undervoltage and overvoltage. These products detect single phasing and unbalanced voltages regardless of any regenerative voltages.

Utilizing an advanced microprocessor-based design allows true RMS voltage measurement with full wave monitoring. This provides a more accurate method to measure the voltages, regardless of load type or wave shape, and results in improved protection across more applications.

True RMS voltage measurement ensures accurate sensing in most generator and other applications with non-sinusoidal wave forms, eliminating nuisance tripping. Full wave monitoring provides a more accurate method to measure the voltages, regardless of load type or wave shape, resulting in improved protection across more applications.

Unlike similar three-phase monitor relays, the PMPU-FA8 Series will continue to function even with a lost phase. They are the only line-powered units in their class to retain fault indication and continuous monitoring of all voltages during a phase loss, increasing the ease of troubleshooting and the level of protection.

The PMPU-FA8 Series is a true universal product, with three units that work on a wide variety of adjustable line-line voltages to cover more global applications. All other settings for undervoltage trip point, trip delay, restart delay and unbalance trip point are fixed for ease of setup. They utilize an industry-standard 8 pin octal socket.

Operation:

When the proper three-phase line voltage is applied to the unit and the phase sequence (rotation) is correct, the relay is energized after the Restart Delay is completed. Any one of five fault conditions will de-energize the relay after a delay. As standard, re-energization is automatic upon correction of the fault condition. Manual reset is available if an external momentary N.C. switch is connected to pins 6 and 7. A bi-color status LED indicates normal condition and also provides specific fault indication to simplify troubleshooting.

PMPU-FA8 Series

PROTECTS AGAINST	LINE-LINE VOLTAGE▲ 50/60 Hz	CATALOG NUMBER	WIRING/SOCKET
Phase Loss, Phase Reversal, Phase Unbalance, Undervoltage & Overvoltage	190-500V	PMPU-FA8 ● ■	8 Pin Octal 70169-D DIAGRAM 104

- ▲ Phase-to-Phase (Line-to-Line).
- Requires a 600V-rated socket when used on system voltages above 300V.
- Dual range unit auto-senses between the 190-250V AC and 350-500V AC ranges (see Application Data on next page).

Sockets & Accessories available

PHASE LOSS, PHASE REVERSAL, PHASE UNBALANCE, UNDERVOLTAGE & OVERVOLTAGE

PMPU-FA8 SERIES

APPLICATION DATA

Voltage Requirements:

RANGE (50/60Hz ±5%)	MIN VOLTAGE	MAX VOLTAGE	CATALOG NUMBER
190-500V AC (see below)	156V AC	550V AC	PMPU-FA8

Three-Phase Line-Line Voltage:

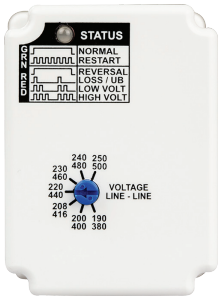

The Voltage Line-Line knob on the PMPU-FA8 has two ranges (left): a 190-250V low voltage scale and a 380-500V high voltage scale. The unit auto senses the 3-phase line-line voltage when applied and automatically selects the appropriate range.

Power Consumption: Less than 40VA.

Phase Loss: Unit trips on loss of any Phase A, B or C, regardless of any regenerative voltages.

Phase Reversal (Out-of-Sequence): Unit trips if sequence (rotation) of the three phases is anything other than A-B-C. It will not work on C-B-A.

Undervoltage: Fixed at 90% of the line voltage setting. Unit trips when the average of all three lines is less than the adjusted set point for a period longer than the fixed 4 second trip delay. It will reset at +3% of the Undervoltage trip setting.

Overvoltage: Fixed at 110% of the line voltage setting. Unit trips when the average of all three lines is greater than the fixed set point for a period longer than the fixed 4 second trip delay. It will reset at 107% of the line voltage setting.

Phase Unbalance: Fixed at 6% unbalance. Unit trips when any one of the three lines deviates from the average of all three lines by more than the adjusted set point for a period longer than the fixed 4 second trip delay.

Response Times:

Restart:	2 seconds fixed
Drop-out Due to Fault:	
Phase Loss and Reversal:	100ms fixed
Undervoltage and Overvoltage:	4 seconds fixed
Unbalance:	
Normal:	4 seconds fixed
Severe (>12%):	0.25 seconds fixed

Output Contacts: SPDT 10 A @ 277V AC / 7A @ 30V DC;
1HP @ 250V AC, 1/2HP @ 125V AC,
C300 Pilot Duty

Life: Mechanical: 10,000,000 operations; Full Load: 100,000 operations

Temperature: Operating: -28° to 65°C (-18° to 149°F)
Storage: -40° to 85°C (-40° to 185°F)

Mounting: Uses an 8 pin octal socket. Requires a 600V-rated socket when used on system voltages greater than 300V such as Macromatic Catalog Number 70169-D.

Status LED:

LED STATUS	STATUS
	NORMAL (RELAY ON)
	RESTART (DELAY)
	REVERSAL
	LOSS/UB (UNBALANCE)
	LOW VOLT (UNDERVOLTAGE)
	HIGH VOLT (OVERVOLTAGE)

Reset: As standard, the PMPU-FA Series relays are in the Automatic Reset mode. However, they can be set in the Manual Reset mode by connecting an external N.C. switch across terminals 6 and 7. Upon application of line voltage, the PMPU-FA8 Series will go into Manual Reset mode if it recognizes a closure across terminals 6 and 7. After a fault clears, the relay will not reset until the N.C. switch is opened. **Note:** When the unit is in the Manual Reset mode, the N.C. switch must be opened after each Power-up to reset the relay and resume normal operation.

Approvals:



File #E109466

with appropriate socket File #E109466

Low Voltage & EMC Directives
EN60947-1, EN60947-5-1

DIMENSIONS

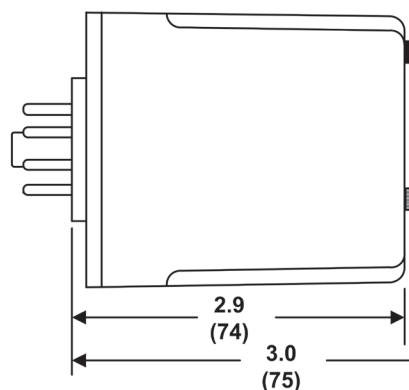
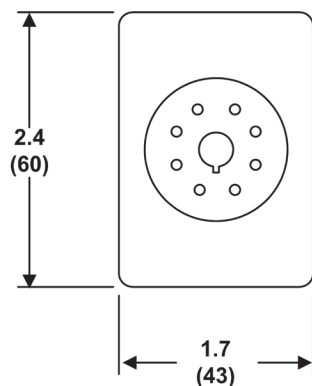

All Dimensions in Inches (Millimeters)

PHASE LOSS, PHASE REVERSAL, PHASE UNBALANCE, UNDERVOLTAGE & OVERVOLTAGE

PMPU-FA8X & PMPU-FA12X SERIES

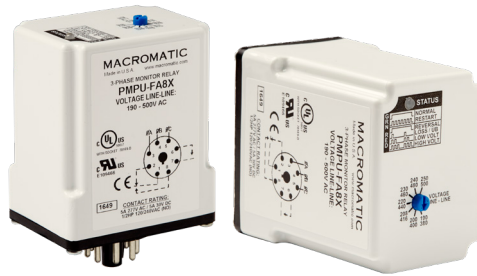

- ◆ Protects against phase loss, phase reversal, phase unbalance, undervoltage, overvoltage & rapid cycling
- ◆ Universal voltage range of 190-500V—greater range that covers more global applications
- ◆ True RMS voltage measurement ensures accurate sensing across more applications
- ◆ Retains fault indication and continues monitoring all voltages even with a lost phase
- ◆ Full fault indication on top of unit for easy troubleshooting
- ◆ 5A SPDT/SPNO (PMPU-FA8X) or 5A DPDT (PMPU-FA12X) output provides isolated contact for alarm circuits



Better. By Design.

800.238.7474

WWW.MACROMATIC.COM

SALES@MACROMATIC.COM

The PMPU-FA8X & PMPU-FA12X Series Three-Phase Monitor Relays continuously monitor all voltages to protect motors and equipment from expensive damage due to phase loss, phase reversal, phase unbalance, undervoltage and overvoltage. These products detect single phasing and unbalanced voltages regardless of any regenerative voltages.

Utilizing an advanced microprocessor-based design allows true RMS voltage measurement with full wave monitoring. This provides a more accurate method to measure the voltages, regardless of load type or wave shape, and results in improved protection across more applications.

True RMS voltage measurement ensures accurate sensing in most generator and other applications with non-sinusoidal wave forms, eliminating nuisance tripping. Full wave monitoring provides a more accurate method to measure the voltages, regardless of load type or wave shape, resulting in improved protection across more applications.

Unlike similar three-phase monitor relays, these products will continue to function even with a lost phase. They are the only line-powered units in their class to retain fault indication and continuous monitoring of all voltages during a phase loss, increasing the ease of troubleshooting and the level of protection.

The PMPU-FA8X & PMPU-FA12X Series are true universal products that work on a wide variety of adjustable line-line voltages to cover more global applications. All other settings for undervoltage trip point, trip delay, restart delay and unbalance trip point are fixed for ease of setup. Both these products offer more than the standard SPDT output contacts. An extra NC contact can provide an isolated output for alarm circuits. The PMPU-FA8X uses a standard 8 pin octal socket even with the extra contact, and the PMPU-FA12X uses a 12 pin square socket (see www.macromatic.com/fa8x).

Operation:

When the proper three-phase line voltage is applied to the unit and the phase sequence (rotation) is correct, the relay is energized after the Restart Delay is completed. Any one of five fault conditions will de-energize the relay. Re-energization of the relay is automatic upon correction of the fault condition. A bi-color status LED indicates normal condition and also provides specific fault indication to simplify troubleshooting.

PMPU-FA8X & PMPU-FA12X Series

PROTECTS AGAINST	LINE-LINE VOLTAGE▲ 50/60 Hz	CATALOG NUMBER	WIRING/SOCKET
Phase Loss, Phase Reversal, Phase Unbalance, Undervoltage & Overvoltage	190-500V	PMPU-FA8X ● ■	8 Pin Octal 70169-D DIAGRAM 175
Phase Loss, Phase Reversal, Phase Unbalance, Undervoltage & Overvoltage	190-500V	PMPU-FA12X ● ■	12 Pin Square SD12-PC DIAGRAM 174

▲ Phase-to-Phase (Line-to-Line).

● Requires a 600V-rated socket when used on system voltages above 300V.

■ Dual range unit auto-senses between the 190-250V AC and 350-500V AC ranges (see Application Data on next page).

Sockets & Accessories available

PHASE LOSS, PHASE REVERSAL, PHASE UNBALANCE, UNDERVOLTAGE & OVERVOLTAGE

PMPU-FA8X & PMPU-FA12X SERIES

APPLICATION DATA

Voltage Requirements:

RANGE (50/60Hz ±5%)	MIN VOLTAGE	MAX VOLTAGE	CATALOG NUMBER
190-500V AC (see below)	156V AC	550V AC	PMPU-FA8X PMPU-FA12X

Three-Phase Line-Line Voltage:

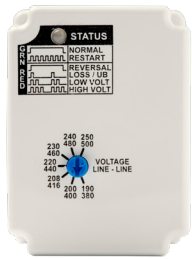

The Voltage Line-Line knob on the PMPU-FA8X & PMPU-FA12X has two ranges (left): a 190-250V low voltage scale and a 380-500V high voltage scale. The unit auto senses the 3-phase line-line voltage when applied and automatically selects the appropriate range.

Power Consumption: Less than 40VA.

Phase Loss: Unit trips on loss of any Phase A, B or C, regardless of any regenerative voltages.

Phase Reversal (Out-of-Sequence): Unit trips if sequence (rotation) of the three phases is anything other than A-B-C. It will not work on C-B-A.

Undervoltage: Fixed at 90% of the line voltage setting. Unit trips when the average of all three lines is less than the adjusted set point for a period longer than the fixed 4 second trip delay. It will reset at +3% of the Undervoltage trip setting.

Overvoltage: Fixed at 110% of the line voltage setting. Unit trips when the average of all three lines is greater than the fixed set point for a period longer than the fixed 4 second trip delay. It will reset at 107% of the line voltage setting.

Phase Unbalance: Fixed at 6% unbalance. Unit trips when any one of the three lines deviates from the average of all three lines by more than the adjusted set point for a period longer than the fixed 4 second trip delay.

Response Times:

Restart:	2 seconds fixed
Drop-out Due to Fault:	
Phase Loss and Reversal:	100ms fixed
Undervoltage and Overvoltage:	4 seconds fixed
Unbalance:	
Normal:	4 seconds fixed
Severe (>12%):	0.25 seconds fixed

Output Contacts: 5A @ 277V AC / 5A 30V DC; 1/3HP @ 120/240V AC, B300 Pilot Duty

Life: Mechanical: 10,000,000 operations; Full Load: 100,000 operations

Temperature: Operating: -28° to 65°C (-18° to 149°F)
Storage: -40° to 85°C (-40° to 185°F)

Mounting: Uses an 8 pin octal socket. Requires a 600V-rated socket when used on system voltages greater than 300V such as Macromatic Catalog Number 70169-D (8 pin) or SD12-PC (12 pin).

Status LED:

	LED STATUS	STATUS
GREEN	[High Pulse]	NORMAL (RELAY ON)
	[Low Pulse]	RESTART (DELAY)
RED	[High Pulse]	REVERSAL
	[Low Pulse]	LOSS/UB (UNBALANCE)
	[Low Pulse]	LOW VOLT (UNDERVOLTAGE)
	[Low Pulse]	HIGH VOLT (OVERVOLTAGE)

Reset: Reset is automatic upon correction of fault.

Approvals:

RU US
File #E109466

UL US
LISTED
IND. CONT. EQUIP.
SOULT

CE
Low Voltage & EMC Directives
EN60947-1, EN60947-5-1
with appropriate
socket File #E109466

DIMENSIONS

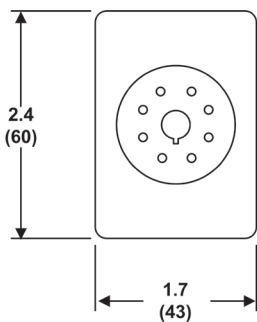

PMPU-FA8X

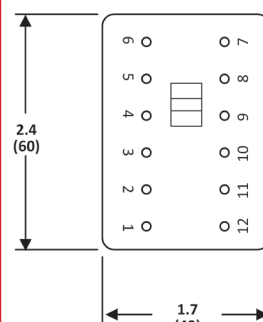
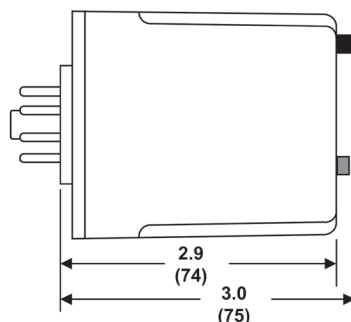

PMPU-FA12X

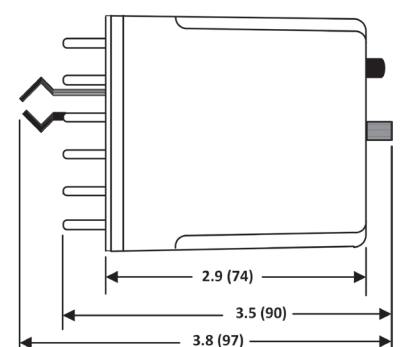

All Dimensions in
Inches (Millimeters)

PHASE LOSS, PHASE REVERSAL, PHASE UNBALANCE, UNDERVOLTAGE & OVERVOLTAGE

PMD SERIES



- ◆ Protects against phase loss, phase reversal, phase unbalance, undervoltage, overvoltage & rapid cycling
- ◆ Wide voltage ranges to cover more global applications
- ◆ True RMS voltage measurement ensures accurate sensing across more applications
- ◆ Retains fault indication and continues monitoring all voltages even with a lost phase
- ◆ Full fault indication on top of unit for easy troubleshooting
- ◆ Manual reset option works with external switch to reset the relay from outside the enclosure
- ◆ Compact 52.5mm wide enclosure for both DIN-rail or panel-mount
- ◆ 10A DPDT output contacts



Better. By Design.

800.238.7474

WWW.MACROMATIC.COM

SALES@MACROMATIC.COM

The PMD Series Three-Phase Monitor Relays continuously monitor all voltages to protect motors and equipment from expensive damage due to phase loss, phase reversal, phase unbalance, undervoltage and overvoltage. These products detect single phasing and unbalanced voltages regardless of any regenerative voltages.

Utilizing an advanced microprocessor-based design allows true RMS voltage measurement with full wave monitoring. This provides a more accurate method to measure the voltages, regardless of load type or wave shape, and results in improved protection across more applications.

True RMS voltage measurement ensures accurate sensing in most generator and other applications with non-sinusoidal wave forms, eliminating nuisance tripping. Full wave monitoring provides a more accurate method to measure the voltages, regardless of load type or wave shape, resulting in improved protection across more applications.

Unlike similar three-phase monitor relays, the PMD Series will continue to function even with a lost phase. They are the only line-powered units in their class to retain fault indication and continuous monitoring of all voltages during a phase loss, increasing the ease of troubleshooting and the level of protection.

The PMD Series is a true universal product, with three units that work on a wide variety of adjustable line-line voltages to cover more global applications. Additional knobs allow adjustment of the undervoltage trip point, trip delay, restart delay and unbalance trip point. They utilize an enclosure for DIN-rail mounting that meets IEC Standards.

Operation:

When the proper three-phase line voltage is applied to the unit and the phase sequence (rotation) is correct, the relay is energized after the Restart Delay is completed. Any one of five fault conditions will de-energize the relay after a delay. As standard, re-energization is automatic upon correction of the fault condition. Manual reset is available if an external momentary N.C. switch is connected to terminals 4 & 5. A bi-color status LED indicates normal condition and also provides specific fault indication to simplify troubleshooting.

PROTECTS AGAINST	NOMINAL VOLTAGE▲ 50/60 Hz	CATALOG NUMBER	WIRING
Phase Loss, Phase Reversal, Phase Unbalance, Undervoltage & Overvoltage	102-138V	PMD120	
	190-500V	PMDU ■	
	460-600V	PMD575	

- ▲ Phase-to-Phase (Line-to-Line).
- Dual range unit auto-senses between the 190-250V AC and 350-500V AC ranges (see Application Data on next page).

Accessories available

PHASE LOSS, PHASE REVERSAL, PHASE UNBALANCE, UNDERVOLTAGE & OVERVOLTAGE

PMD SERIES

APPLICATION DATA

Voltage Requirements:

RANGE (50/60Hz ±5%)	MIN VOLTAGE	MAX VOLTAGE	CATALOG NUMBER
102-138V AC	77V AC	152V AC	PMD120
190-500V AC (see below)	156V AC	550V AC	PMDU
460-600V AC	345V AC	660V AC	PMD575

Three-Phase Line-Line Voltage:

The Voltage Line-Line knob on the PMDU has two ranges (right): a 190-250V low voltage scale and a 380-500V high voltage scale. The unit auto senses the three-phase line-line voltage when applied and automatically selects the appropriate range.

The PMD120 has a single adjustable range of 102-138V and the PMD575 has a single adjustable range of 460-600V.

Power Consumption: Less than 40VA.

Phase Loss: Unit trips on loss of any Phase A, B or C, regardless of any regenerative voltages.

Phase Reversal (Out-of-Sequence): Unit trips if sequence (rotation) of the three phases is anything other than A-B-C. It will not work on C-B-A.

Undervoltage: Adjustable from 80-95% of the line voltage setting. Unit trips when the average of all three lines is less than the adjusted set point for a period longer than the adjustable trip delay. It will reset at +3% of the Undervoltage trip setting.

Overvoltage: Fixed at 110% of the line voltage setting. Unit trips when the average of all three lines is greater than the fixed set point for a period longer than the adjustable trip delay. It will reset at 107% of the line voltage setting.

Phase Unbalance: Adjustable from 2 - 10% unbalance. Unit trips when any one of the three lines deviates from the average of all three lines by more than the adjusted set point for a period longer than the adjustable trip delay.



PMD Series with mounting clips extended

Response Times:

Restart:	1 - 300 seconds adjustable
Drop-out Due to Fault:	
Phase Loss and Reversal:	100ms fixed
Undervoltage and Overvoltage:	0.3 - 30 seconds adjustable
Unbalance:	
Normal:	0.3 - 30 seconds adjustable
Severe (Twice Knob Setting):	0.3 - 2 seconds

Output Contacts: DPDT 10 A @ 277V AC / 10A @ 30V DC;
1/2HP @ 120/240V AC (N.O.),
1/3HP @ 120/240V AC (N.C.),
B300 Pilot Duty, R300 (N.O.)

Life: Mechanical: 10,000,000 operations; Full Load: 100,000 operations

Temperature: Operating: -28° to 65°C (-18° to 149°F)
Storage: -40° to 85°C (-40° to 185°F)

Mounting: Mounts on 35mm DIN-rail or panel-mounted with two #8 screws when DIN-rail clips are fully extended from under the enclosure.

Status LED:

LED STATUS	STATUS
GREEN	NORMAL (RELAY ON)
RED	RESTART (DELAY)
RED	REVERSAL
RED	LOSS/UB (UNBALANCE)
RED	LOW VOLT (UNDERVOLTAGE)
RED	HIGH VOLT (OVERVOLTAGE)

Reset: As standard, the PMD Series relays are in the Automatic Reset mode. However, they can be set in the Manual Reset mode by connecting an external N.C. switch across terminals 4 and 5. Upon application of line voltage, the PMD Series will go into Manual Reset mode if it recognizes a closure across terminals 4 and 5. After a fault clears, the relay will not reset until the N.C. switch is opened.

Note: When the unit is in the Manual Reset mode, the N.C. switch must be opened after each Power-up to reset the relay and resume normal operation.

Termination: Cage-clamp screw terminals
Plus-minus screws accept flat and phillips head tools
Recommended tightening torque of 7 in-lbs
Accepts solid or stranded wire 12-30 AWG

Approvals:



File # E109466



Low Voltage & EMC Directives
EN60947-1, EN60947-5-1

DIMENSIONS

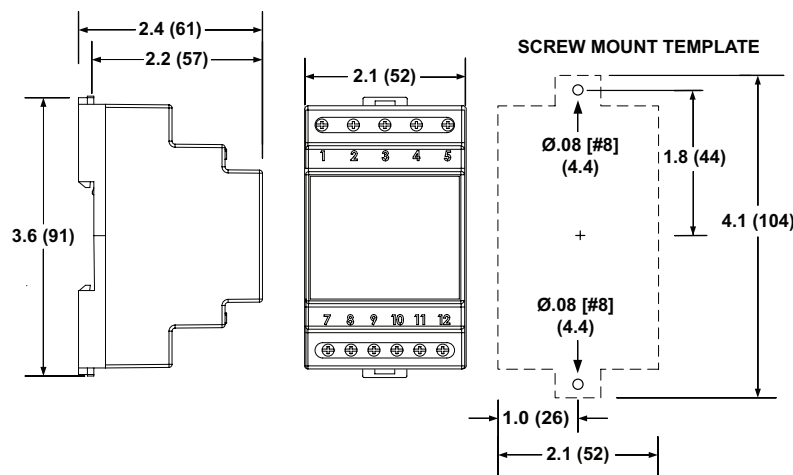

All Dimensions
in Inches
(Millimeters)

PHASE LOSS, PHASE REVERSAL & PHASE UNBALANCE

PBDU SERIES

THREE-PHASE MONITOR RELAYS | DIN-RAIL



- ◆ Protects against phase loss, phase reversal and phase unbalance
- ◆ Compact 17.5 mm wide enclosure for DIN-rail mounting
- ◆ Universal voltage range: 208 - 480V AC
- ◆ LED status indication on front face for easy troubleshooting
- ◆ 5A SPDT output contact



The PBDU Series Phase Monitor Relays protect motors and equipment from damage due to voltage faults on three-phase systems. PBDU relays monitor phase loss, phase reversal, and unbalance. Phase unbalance is adjustable from 5% to 25%, and can be disabled altogether if desired.

The compact 17.5 mm enclosure for DIN-rail mounting conserves space and reduces installation time.

LED status indication is located on the front face. Green indicates Power ON. Yellow indicates relay status. Any of the three fault conditions will de-energize the relay after a fixed trip delay of 100 ms. Re-energization is automatic upon correction of the fault condition.

Monitored voltage is universal: 208V - 480V AC.

PROTECTS AGAINST	MONITORED VOLTAGE 50/60 HZ	CATALOG NUMBER	WIRING
Phase Loss, Phase Reversal, Phase Unbalance	208 – 480V AC ■	PBDU	<p>DIAGRAM 823</p>
■ Phase-to-Phase (Line-to-Line)			



Better. By Design.

800.238.7474
WWW.MACROMATIC.COM
SALES@MACROMATIC.COM

PHASE LOSS, PHASE REVERSAL & PHASE UNBALANCE

PBDU SERIES

APPLICATION DATA

Voltage Requirements:

RANGE (50/60Hz ±5%)	MIN VOLTAGE	MAX VOLTAGE	CATALOG NUMBER
208 – 480V AC	187V AC	528V AC	PBDU

Power Consumption:

10VA (1W) @ 400V / 50Hz
16VA (1.5W) @ 480V / 60Hz

IP Rating: IP 20

Phase Loss:

Unit trips on loss of any Phase L1, L2 or L3, regardless of any regenerative voltages.

Phase Reversal (Out-of-Sequence):

Unit trips if sequence (rotation) of the three phases is anything other than L1-L2-L3.

It will not work on L3-L2-L1.

Phase Unbalance: Adjustable from 5 - 25% unbalance or can be disabled. Unit trips when any one of the three lines deviates from the average of all three lines by more than the adjusted set point for a period longer than the adjustable trip delay.

Time Range: Trip delay, fixed 100 ms

Accuracy: ≤5%

Repeat accuracy, ±2%

Temperature influence, ≤0.05% / °C

Output Contacts: SPDT 5A @ 250V AC

Life:

Mechanical - 20,000,000 operations;
Electrical - 200,000 operations at 1000 VA resistive load

Temperature:

Operating, -25 to +55°C (ambient temperatures above 40°C, a side distance to other units of 5 mm must be observed).
Storage, -25 to 75°C

Humidity: -15% to 85%

Mounting: Mounts on 35mm DIN-rail

Indicators:

Green LED ON, indicates Power ON

Yellow LED ON, indicates relay status is energized

Termination:

1 x #14-20 AWG

2 x #16-20 AWG

Recommended tightening torque of 0.7 ft.lb. (1 Nm) maximum

Weight:

Single packing, 0.16 lb (72 g)

Approvals:



File # E236146

DIMENSIONS

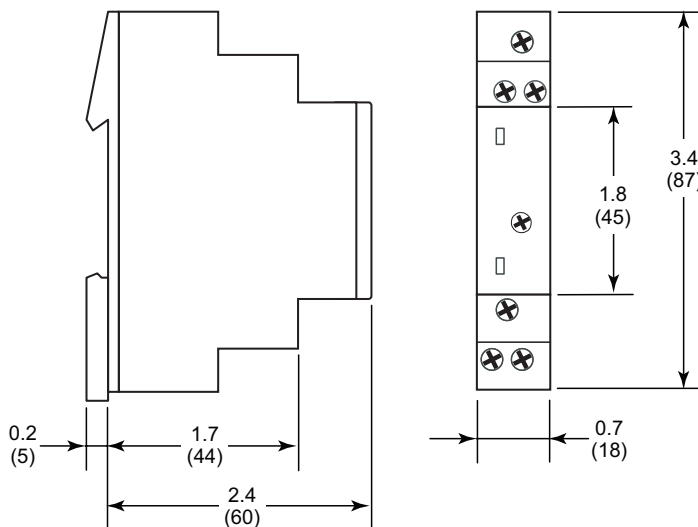

All Dimensions in
Inches (Millimeters)

SOCKETS & ACCESSORIES

8 Pin Octal Socket- Surface or DIN Rail-Mounted

- ◆ 10A @ 600V
- ◆ 1 or 2 #12-20 AWG Wire
- ◆ Pressure Wire Clamp Terminations
- ◆ Recommended Tightening Torque 12 in-lbs



File #E169693 File #LR701114



Catalog Number:
70169-D

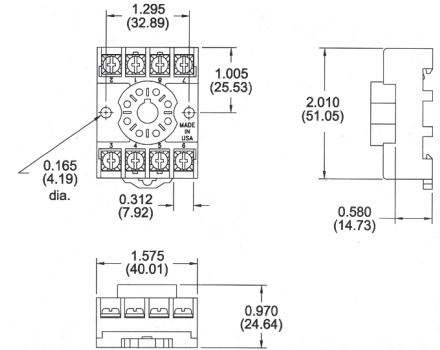
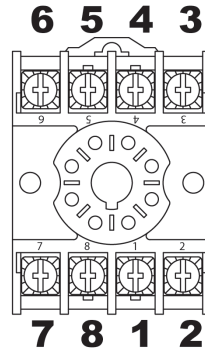

12 Pin Socket Surface-Mounted

- ◆ 10A @ 600V
- ◆ #12-20 AWG Wire
- ◆ Pressure Wire Clamp Terminations
- ◆ Recommended Tightening Torque 12 in-lbs

NOTE: If a 12 Pin Socket is required for DIN-rail mounting, please contact Macromatic.



Catalog Number SD12-PC

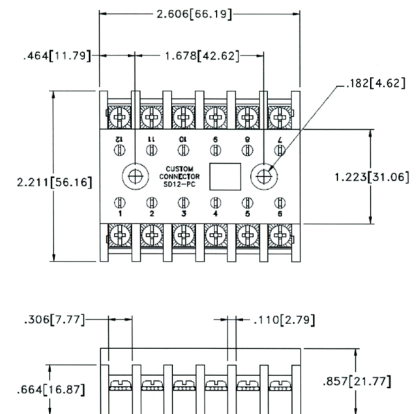
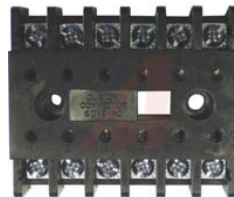

Hold Down Spring

Can be used for:

- ◆ Panel-Mounted Sockets
 - ◆ Sockets Mounted to 35mm DIN Rail *
- * Requires two #8, 3/4" length machine screws with washers & nuts--contact Macromatic or www.macromatic.com/70166 for more information.



Catalog Number: 70166

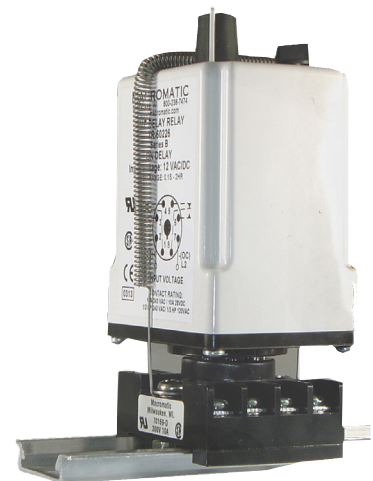

MACROMATIC INDUSTRIAL CONTROLS

Located in Menomonee Falls, Wisconsin, Macromatic Industrial Controls engineers and manufactures industrial relays that control electrical processes and monitor power for damaging fault conditions.

Macromatic provides solutions for almost any application in any industry. Macromatic's products are used in the HVACR, pump control, material handling, motor control, generator, and lift and elevator industries, plus more.

As an independently-owned manufacturer of state-of-the-art control and monitoring products for over 40 years, Macromatic takes pride in its short lead-time, flexible product design, and exceptional technical support.

Visit www.macromatic.com today.



Better. By Design.

800.238.7474 | WWW.MACROMATIC.COM | SALES@MACROMATIC.COM

MACROMATIC INDUSTRIAL CONTROLS

FAMILY OF PRODUCTS

MACROMATIC INDUSTRIAL CONTROLS

MACROMATIC
Better. By Design.

ALTERNATING RELAYS



800.238.7474 | WWW.MACROMATIC.COM | SALES@MACROMATIC.COM

CATALOG OF PRODUCTS

MACROMATIC
Better. By Design.

CURRENT SENSING RELAYS



800.238.7474 | WWW.MACROMATIC.COM | SALES@MACROMATIC.COM

CATALOG OF PRODUCTS

MACROMATIC
Better. By Design.

INTRINSICALLY SAFE PRODUCTS



MACROMATIC INDUSTRIAL CONTROLS, INC. | 800.238.7474 | WWW.MACROMATIC.COM | SALES@MACROMATIC.COM

CATALOG OF PRODUCTS

MACROMATIC
Better. By Design.

LIQUID LEVEL CONTROL RELAYS



800.238.7474 | WWW.MACROMATIC.COM | SALES@MACROMATIC.COM

CATALOG OF PRODUCTS

MACROMATIC
Better. By Design.

THREE-PHASE MONITOR RELAYS



800.238.7474 | WWW.MACROMATIC.COM | SALES@MACROMATIC.COM

CATALOG OF PRODUCTS

MACROMATIC
Better. By Design.

SEAL LEAKAGE & OVER TEMPERATURE RELAYS



800.238.7474 | WWW.MACROMATIC.COM | SALES@MACROMATIC.COM

CATALOG OF PRODUCTS

MACROMATIC
Better. By Design.

TIME DELAY RELAYS



800.238.7474 | WWW.MACROMATIC.COM | SALES@MACROMATIC.COM

CATALOG OF PRODUCTS

MACROMATIC
Better. By Design.

VOLTAGE MONITOR RELAYS



800.238.7474 | WWW.MACROMATIC.COM | SALES@MACROMATIC.COM

CATALOG OF PRODUCTS

MACROMATIC
Better. By Design.

PERCENTAGE TIMERS



800.238.7474 | WWW.MACROMATIC.COM | SALES@MACROMATIC.COM

CATALOG OF PRODUCTS



Better. By Design.

MACROMATIC
Better. By Design.

GENERAL PURPOSE RELAYS



MACROMATIC INDUSTRIAL CONTROLS, INC. | 800.238.7474 | WWW.MACROMATIC.COM | SALES@MACROMATIC.COM

CATALOG OF PRODUCTS

800.238.7474 | WWW.MACROMATIC.COM | SALES@MACROMATIC.COM

1.15.20

Specifications subject to change without notice | Macromatic is a registered trademark of Macromatic Industrial Controls, Inc.