

MDT0430A01ISC-RGB	480 x 272	RGB Interface	TFT Module
<b>Specification</b>			
Version: 1		Date: 29/08/2019	
<b>Revision</b>			
1	26/08/2019	First issue	

Display Features		
Display Size	4.3"	
Resolution	480 x 272	
Orientation	Landscape	
Appearance	RGB	
Logic Voltage	3.3V	
Interface	RGB	
Brightness	400 cd/m <sup>2</sup>	
Touchscreen	CTP	
Module Size	105.50 x 67.20 x 4.52 mm	
Operating Temperature	-20°C ~ +70°C	
Pinout	40 way FFC	
Pitch	0.5mm	Weight / Display
		—
		—

Display Accessories	
Part Number	Description

Optional Variants	
Appearances	Voltage



## General Specifications

	Feature	Spec
Characteristics	Size	4.3 inch
	Resolution	480(horizontal)*272(Vertical)
	Interface	RGB-24bit
	Connect type	Connector
	Display Colors	16.7M
	Technology type	a-Si
	Pixel pitch (mm)	0.198*0.198
	Pixel Configuration	R.G.B-Stripe
	Display Mode	Normally Black
	LCD Driver IC	TBD
	CTP Driver IC	GT911
	Viewing Direction	Full view
Mechanical	LCM (W x H x D) (mm)	105.50*67.20*4.52
	Active Area(mm)	95.04 x53.86
	With/Without TSP	With CTP
	Weight (g)	TBD
	LED Numbers	10 LEDs

Note 1: Requirements on Environmental Protection: RoHs

Note 2: LCM weight tolerance: +/- 5%

design • manufacture • supply



## Input/Output Terminals

### LCD PIN-MAP

No.	Symbol	Description
1	VLED-	Backlight LED Cathode
2	VLED+	Backlight LED Anode.
3	GND	Ground
4	VDD	Power supply
5~12	R0~R7	Data bus
13~20	G0~G7	Data bus
21~28	B0~B7	Data bus
29	GND	Ground
30	DCLK	Dot clock signal input. Latching input data at its rising edge.
31	DISP	Standby mode. Normally pulled high. DISP="1": Normally operation (Default) DISP="0": Timing controller, source driver will turn off ,all output are High-Z.
32	HSYNC	Horizontal sync input. Negative polarity.
33	VSYNC	Vertical sync input. Negative polarity..
34	DE	Data enable input. Active high to enable the input data bus under "DE Mode."
35	NC	No connect
36	GND	Ground
37	XR(NC)	The right side signal of TP
38	YD(NC)	The down side signal of TP
39	XL(NC)	The left side signal of TP
40	YU(NC)	The up side signal of TP

### CTP PIN-MAP

Pin	Signal	Description
1	GND	Ground
2	SDA	I2C data input and output
3	SCL	I2C clock input
4	VDD	Power supply for CTP
5	INT	Interrupt request to the host.
6	RST	Reset Pin for CTP



## Absolute Maximum Rating

Item	Symbol	MIN	Typ	MAX	Unit	Remark
Supply Voltage	VDD	-0.5	-	5	V	-
Operating Temperature	TOPR	-30	-	85	°C	-
Storage Temperature	TSTG	-30	-	85	°C	-

## Electrical Characteristics

### Driving TFT LCD Panel

Item	Symbol	MIN	TYP	MAX	Unit	Remark
Supply Voltage	VDD	3.0	3.3	3.6	V	
Input Signal Voltage	Low Level	V <sub>IL</sub>	GND	-	0.3x VDD	V
	High Level	V <sub>IH</sub>	0.7x VDD	-	VDD	V
Output Signal Voltage	Low Level	V <sub>IL</sub>	GND	-	VDD+0.4	V
	High Level	V <sub>IH</sub>	VDD-0.4	-	VDD	V
(Panel+LSI) Power Consumption	Black Mode (60Hz)	-	74	-	nW	
	Standby	-	50	-	uW	

### CTP Electrical Characteristics

FPC Design	Item	Description	Remark
COF	IC solution on TP Model	GT911	
	Display Resolution	480*272	
	Interface Type	I2C	
	I2C Slave Address	OX28	
	Origin of Coordinate	Top left corner	

Parameter	Symbol	Min	Typ	Max	Unit
Interface Signal Voltage	VDDI	-	2.8	-	V
Power Voltage	VDD	-	3.3	-	V



## LED Driving Conditions

Item	Symbol	MIN	TYP	MAX	Unit	Remark
Forward Current	$I_F$	-	40	50	mA	
Forward Voltage	$V_F$	14.8	16	17.2	V	
Backlight Power consumption	$W_{BL}$	-	0.640	0.825	W	
LED Lifetime		-	30000	-	Hrs	

Note 1: Each LED:  $I_F = 20 \text{ mA}$ ,  $V_F = 3.2 \pm 0.2 \text{ V}$ .

Note 2: Optical performance should be evaluated at  $T_a = 25^\circ \text{C}$  only.

Note 3: If LED is driven by high current, high ambient temperature & humidity condition. The life Time of LED will be reduced. Operating life means brightness goes down to 50% initial brightness. Typical operating life time is estimated data.



# Block Diagram

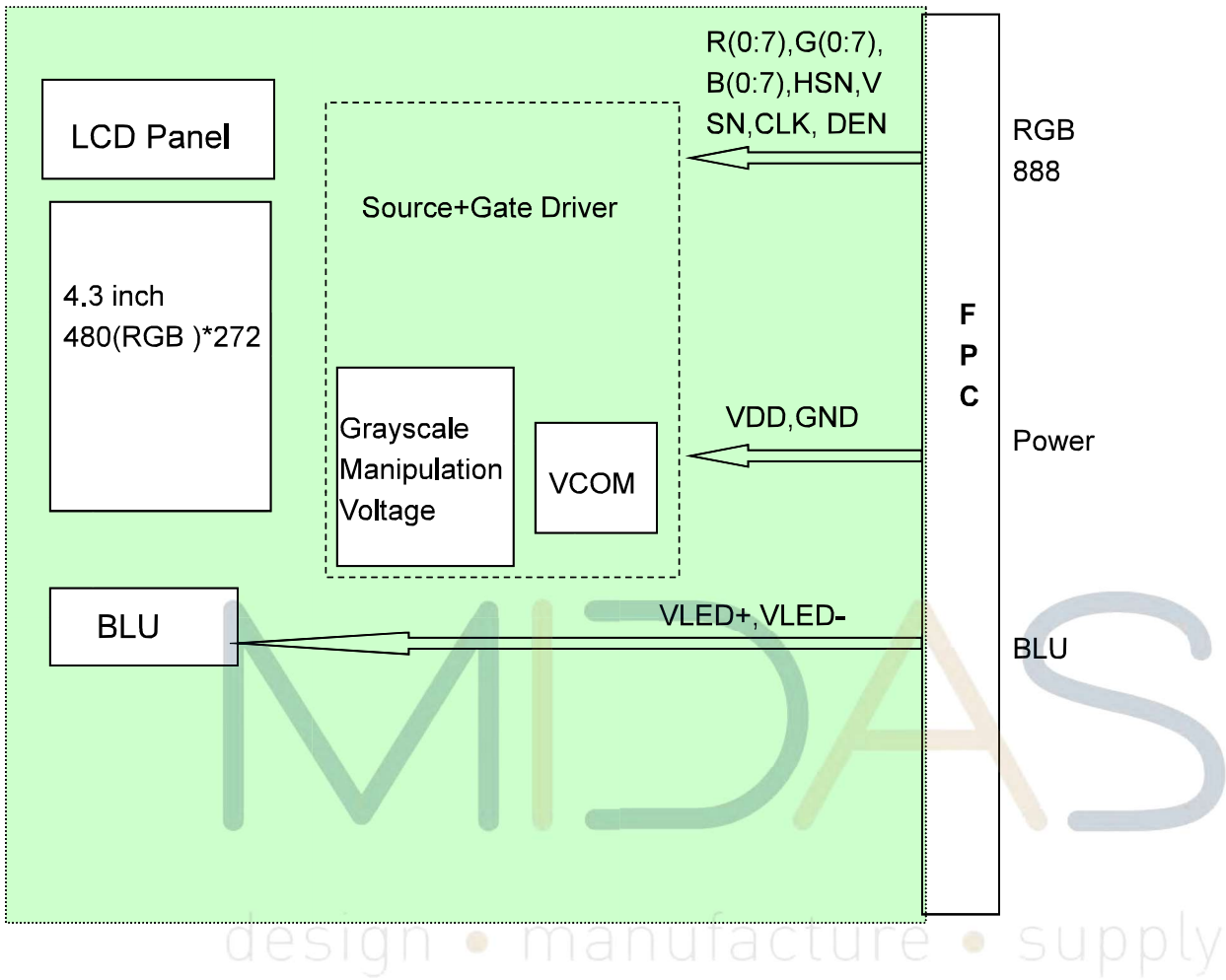

# Interface Timing

## 3-wire Serial Interface

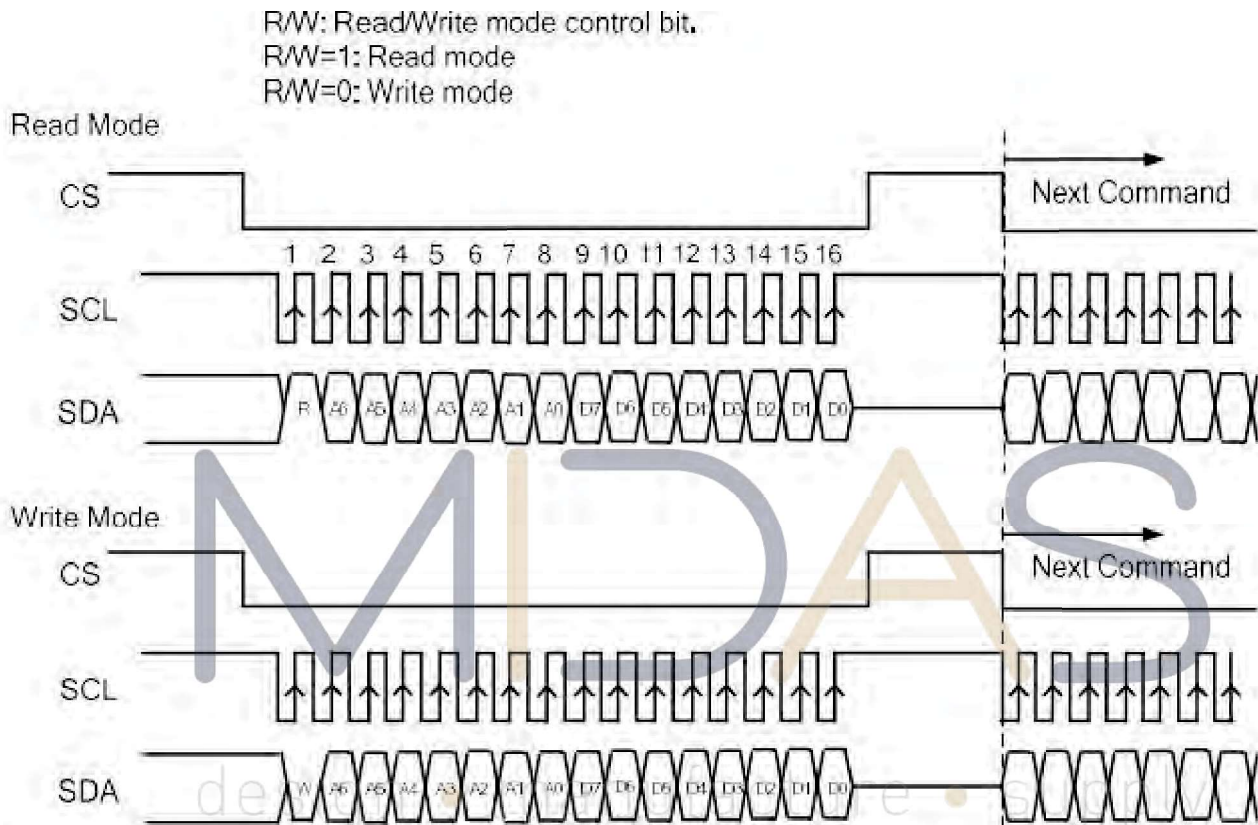

- a. Each serial command consists of 16 bits of data which is loaded one bit a time at the rising edge of serial clock SCL.
- b. Command loading operation starts from the falling edge of CS and is completed at the next rising edge of CS.
- c. The serial control block is operational after power on reset, but commands are established by the VSYNC signal. If command is transferred multiple times for the same register, the last command before the VSYNC signal is valid.
- d. If less than 16 bits of SCL are input while CS is low, the transferred data is ignored.
- e. If 16 bits or more of SCL are input while CS is low, the previous 16 bits of transferred data before then rising edge of CS pulse are valid data.
- f. Serial block operates with the SCL clock
- g. Serial data can be accepted in the power save mode.
- h. After power on reset or GRB reset, it is required 100ms delay to begin SPI communication.



# RGB Interface

## SYNC Mode

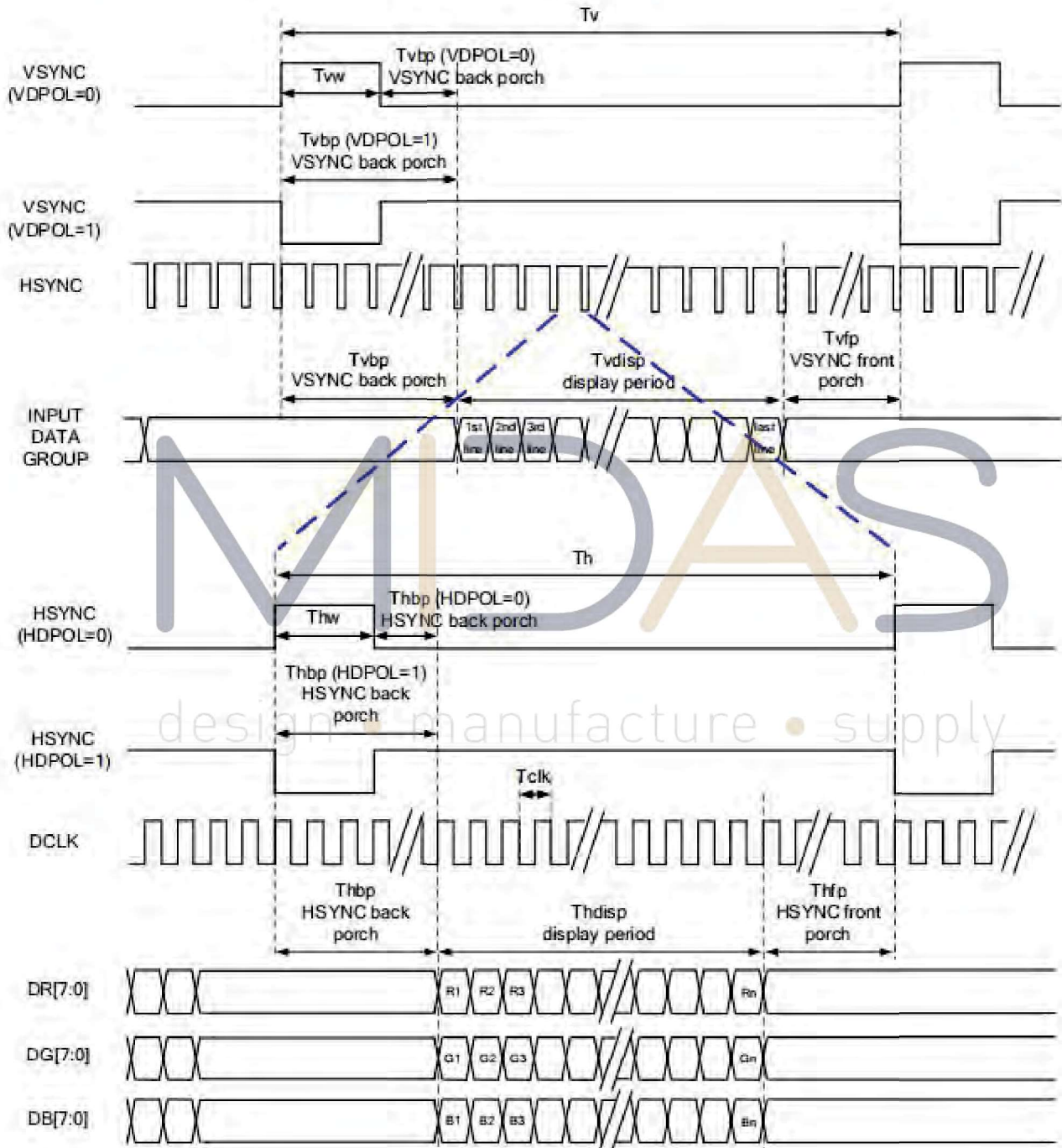



# SYNC-DE Mode

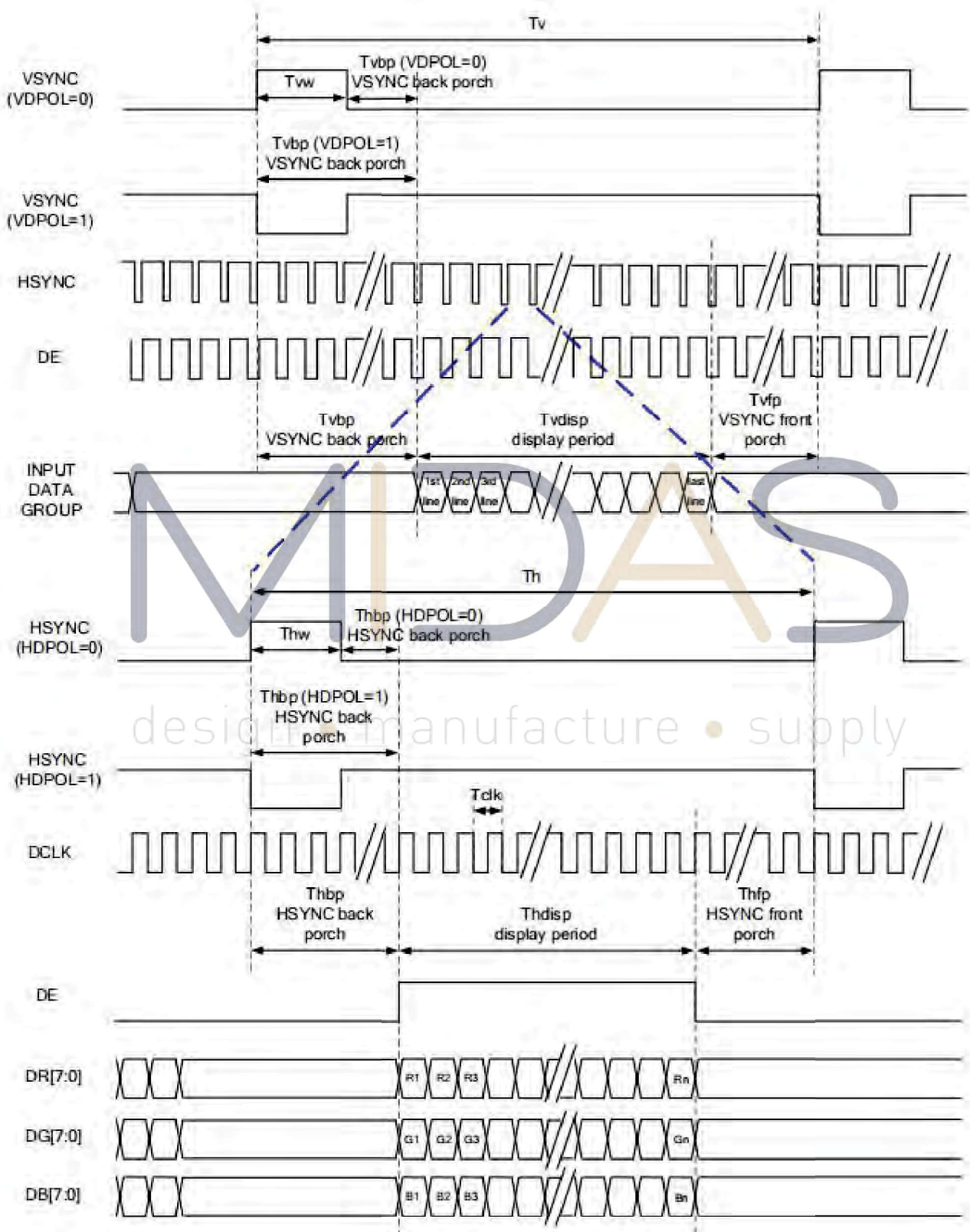

## DE Mode

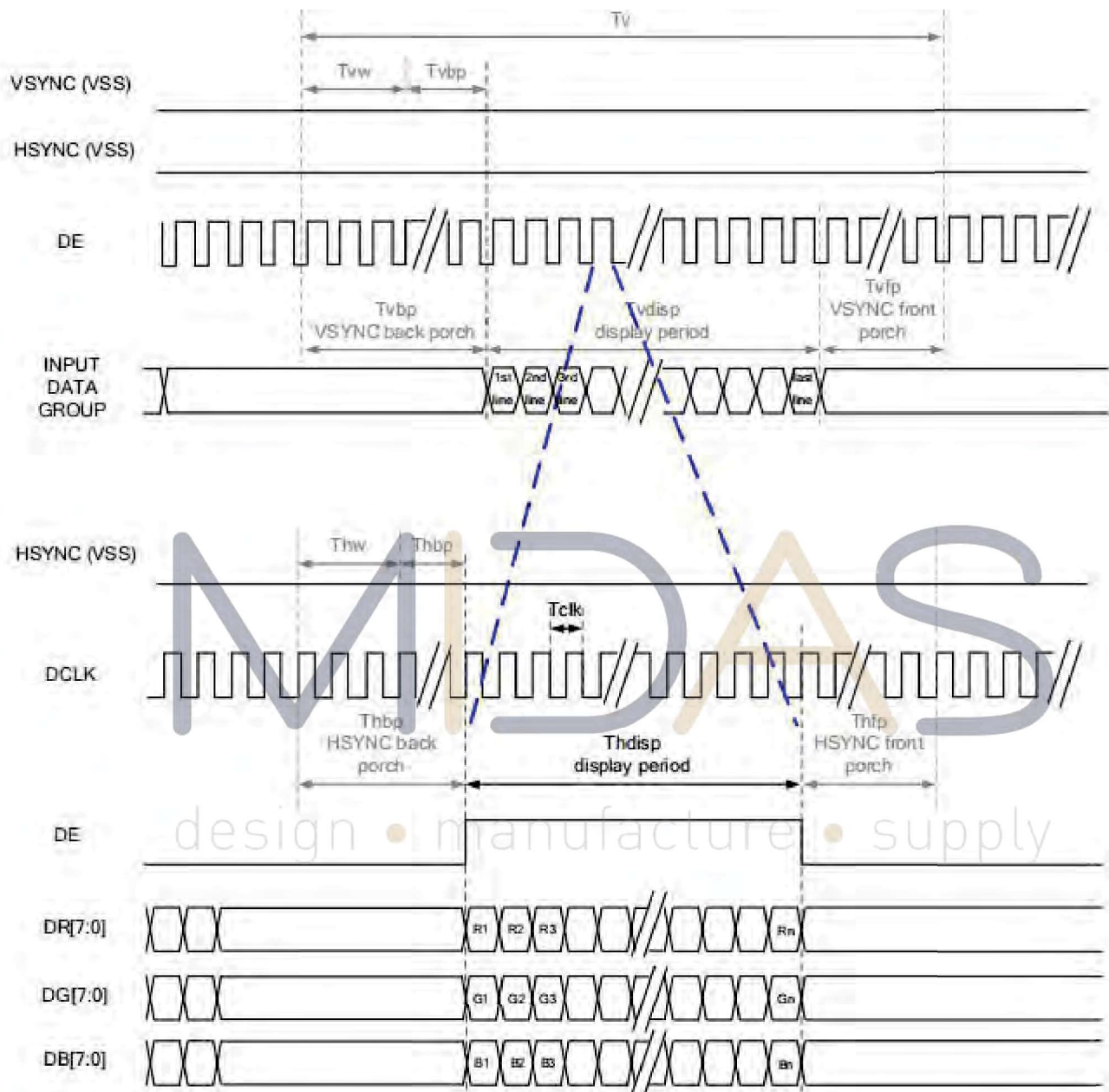

RGB Mode Selection Table	DCLK	HSYNC	VSYNC	DE
SYNC - DE Mode	Input	Input	Input	Input
SYNC Mode	Input	Input	Input	GND
DE Mode	Input	GND	GND	Input

Note: "Input" means these signals are driven by host side.



## Parallel 24 bit RGB Input Timing Table

Parallel 24-bit RGB Input Timing (PVDD=VDD=VDDI= 3.3V, AGND= 0V, TA=25°C)

480RGB X 272 Resolution Timing Table							
Item	Symbol	Min.	Typ.	Max.	Unit	Remark	
DCLK Frequency	Fclk	8	9	12	MHz		
DCLK Period	Tclk	83	111	125	ns		
HSYNC	Period Time	Th	485	531	598	DCLK	
	Display Period	Thdisp		480		DCLK	
	Back Porch	Thbp	3	43	43	DCLK	By H_BLANKING setting
	Front Porch	Thfp	2	8	75	DCLK	
	Pulse Width	Thw	2	4	43	DCLK	
VSYNC	Period Time	Tv	276	292	321	HSYNC	
	Display Period	Tvdisp		272		HSYNC	
	Back Porch	Tvbp	2	12	12	HSYNC	By V_BLANKING setting
	Front Porch	Tvfp	2	8	37	HSYNC	
	Pulse Width	Tvw	2	4	12	HSYNC	

Note: It is necessary to keep Tvbp =12 and Thbp =43 in sync mode. DE mode is unnecessary to keep it.

## Serial 8 bit RGB Input Timing Table

Serial 8-bit RGB Input Timing (PVDD=VDD=VDDI= 3.3V, AGND= 0V, TA=25°C)

480RGB X 272 Resolution Timing Table							
Item	Symbol	Min.	Typ.	Max.	Unit	Remark	
DCLK Frequency	Fclk	24	27	30	MHz		
DCLK Period	Tclk	33	37	42	ns		
HSYNC	Period Time	Th	1445	1491	1558	DCLK	
	Display Period	Thdisp		1440		DCLK	
	Back Porch	Thbp	3	43	43	DCLK	By H_BLANKING setting
	Front Porch	Thfp	2	8	75	DCLK	
	Pulse Width	Thw	2	4	43	DCLK	
VSYNC	Period Time	Tv	276	292	321	HSYNC	
	Display Period	Tvdisp		272		HSYNC	
	Back Porch	Tvbp	2	12	12	HSYNC	By V_BLANKING setting
	Front Porch	Tvfp	2	8	37	HSYNC	
	Pulse Width	Tvw	2	4	12	HSYNC	

Note: It is necessary to keep Tvbp =12 and Thbp =43 in sync mode. DE mode is unnecessary to keep it.



## System Bus Timing for RGB Interface

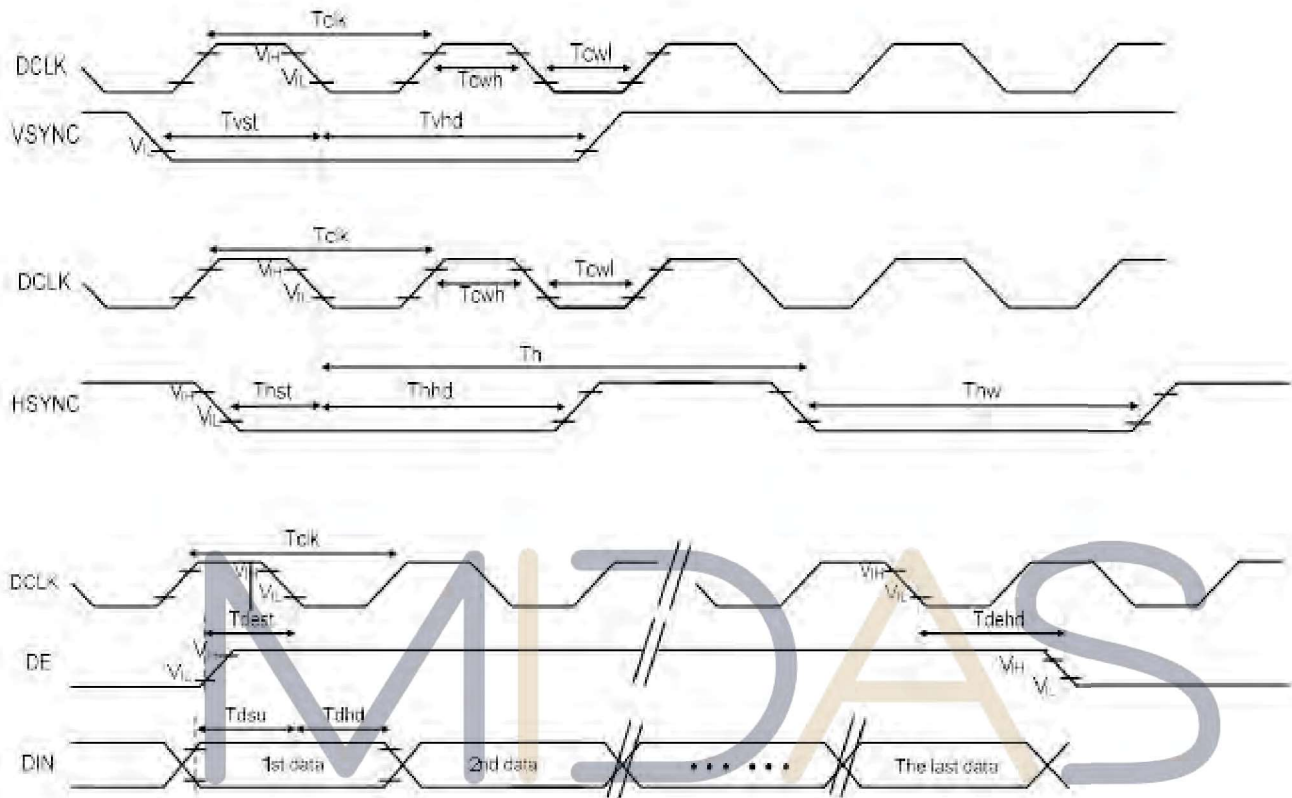

design • manufacture • supply

Item	Symbol	Min.	Typ.	Max.	Unit	Conditions
CLK Pulse Duty	$T_{cw}$	40	50	60	%	
HSYNC Width	$T_{hw}$	2	-	-	DCLK	
HSYNC Period	$T_h$	55	60	65	us	
VSYNC Setup Time	$T_{vst}$	12	-	-	ns	
VSYNC Hold Time	$T_{vhd}$	12	-	-	ns	
HSYNC Setup Time	$T_{hst}$	12	-	-	ns	
HSYNC Hold Time	$T_{hhd}$	12	-	-	ns	
Data Setup Time	$T_{dsu}$	12	-	-	ns	
Data Hold Time	$T_{dhd}$	12	-	-	ns	
DE Setup Time	$T_{dest}$	12	-	-	ns	
DE Hold Time	$T_{dehd}$	12	-	-	ns	



## System Bus Timing for 3-Wire SPI Interface

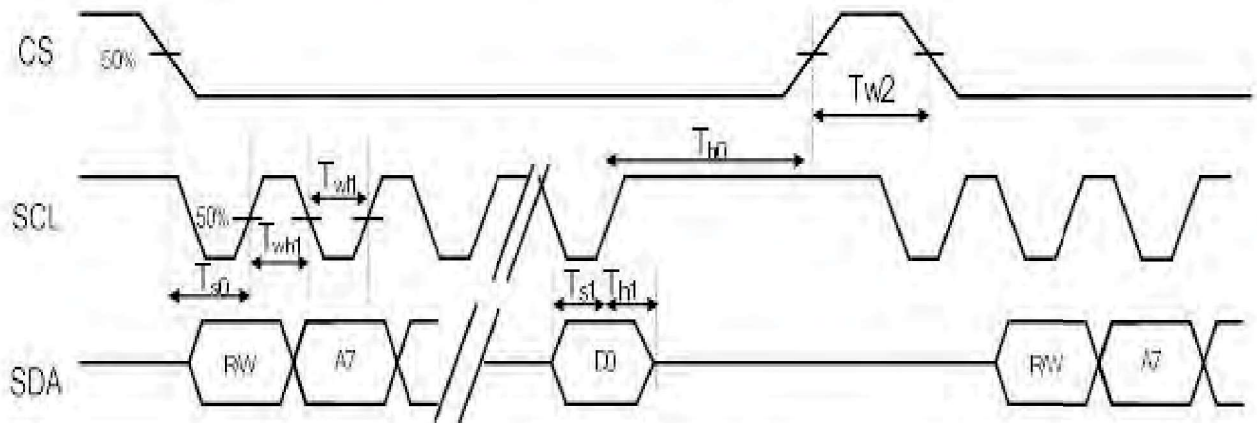

Item	Symbol	Min.	Typ.	Max.	Unit	Conditions
CS Input Setup Time	$T_{s0}$	50	-	-	ns	
Serial Data Input Setup Time	$T_{s1}$	50	-	-	ns	
CS Input Hold Time	$T_{h0}$	50	-	-	ns	
Serial Data Input Hold Time	$T_{h1}$	50	-	-	ns	
SCL Write Pulse High Width	$T_{wh1}$	50	-	-	ns	
SCL Write Pulse Low Width	$T_{wl1}$	50	-	-	ns	
SCL Read Pulse High Width	$T_{rh1}$	300	-	-	ns	
SCL Read Pulse Low Width	$T_{rl1}$	300	-	-	ns	
CS Pulse High Width	$T_{w2}$	400	-	-	ns	



## Optical Characteristics

Items	Symbol	Condition	Min.	Typ.	Max.	Unit	Remark	Note
Response time	Tr+Tf	-	-	30	40	ms	FIG.1	Note4
Contrast Ratio	CR		600	800	-	-	FIG.2	Note1
Surface luminance	LV	$\theta = 0^\circ$	350	400	-	cd/m2	FIG.2	Note2
Luminance uniformity	Yu	$\theta = 0^\circ$	75	80	-	%	FIG.2	Note3
NTSC	-	$\theta = 0^\circ$	-	50	-	%	FIG.2	Note5
Viewing angle	$\theta_T$	Center CR $\geq$ 10	-	80	-	deg	FIG.3	Note6
	$\theta_B$		-	80	-	deg	FIG.3	
	$\theta_L$		-	80	-	deg	FIG.3	
	$\theta_R$		-	80	-	deg	FIG.3	
Chromaticity	Red	$R_X$	TBD	TBD	TBD	-	FIG.2 CIE1931	Note5
		$R_Y$	TBD	TBD	TBD	-		
	Green	$G_X$	TBD	TBD	TBD	-		
		$G_Y$	TBD	TBD	TBD	-		
	Blue	$B_X$	TBD	TBD	TBD	-		
		$B_Y$	TBD	TBD	TBD	-		
	White	$W_X$	TBD	TBD	TBD	-		
		$W_Y$	TBD	TBD	TBD	-		

design • manufacture • supply



**Note1. Definition of contrast ratio**

Contrast ratio(Cr) is defined mathematically by the following formula. For more information see FIG.2.

$$\text{Contrast ratio} = \frac{\text{Luminance measured when LCD on the "White" state}}{\text{Luminance measured when LCD on the "Black" state}}$$

For contrast ratio, Surface Luminance, Luminance uniformity and CIE, the testing data is based on TOPCON's BM-5 or BM-7 photo detector or compatible.

**Note2. Definition of surface luminance.**

Surface luminance is the luminance with all pixels displaying white. For more information see FIG.2.

Lv = Average Surface Luminance with all white pixels (P1, P2, P3, ..., Pn)

**Note3. Definition of luminance uniformity**

The luminance uniformity in surface luminance is determined by measuring luminance at each test position 1 through n, and then dividing the maximum luminance of n points luminance by minimum luminance of n points luminance. For more information see FIG.2.

$$YU = \frac{\text{Minimum surface luminance with all white pixels (P1, P2, P3, ..., Pn)}}{\text{Maximum surface luminance with all white pixels (P1, P2, P3, ..., Pn)}}$$

**Note4. Definition of response time**

The response time is defined as the LCD optical switching time interval between "White" state and "Black" state. Rise time (Tr) is the time between photo detector output intensity changed from 90% to 10%. And fall time (Tf) is the time between photo detector output intensity changed from 10% to 90%.

For additional information see FIG1.

**Note5. Definition of color chromaticity (CIE1931)**

CIE (x,y) chromaticity, The x,y value is determined by screen active area center position P5. For more information see FIG.2.

**Note6. Definition of viewing angle**

Viewing angle is the angle at which the contrast ratio is greater than 10. Angles are determined for the horizontal or x axis and the vertical or y axis with respect to the z axis which is normal to the LCD surface. For more information see FIG.3.

For viewing angle and response time testing, the testing data is based on Autronic-Melchers' s ConoScope or DMS series Instruments or compatible.



**FIG.1. The definition of response Time**

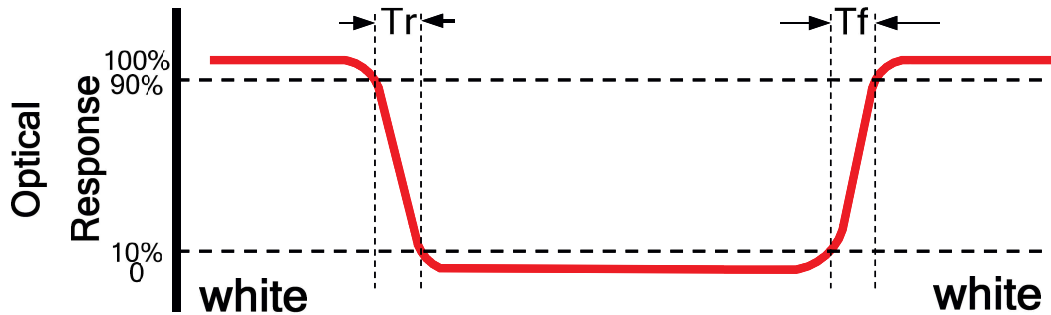

**FIG.2. Measuring method for contrast ratio, surface luminance, luminance uniformity, CIE (x,y) chromaticity**

Size :  $S \leq 5"$  (see Figure a) A : 5 mm B : 5 mm  
 H, V : Active area

Light spot size  $\varnothing = 5\text{mm}$  (BM-5) or  $\varnothing = 7.7\text{mm}$  (BM-7) 50cm distance or compatible distance from the LCD surface to detector lens.

test spot position : see Figure a.

measurement instrument : TOPCON's luminance meter BM-5 or BM-7 or compatible (see Figure c).

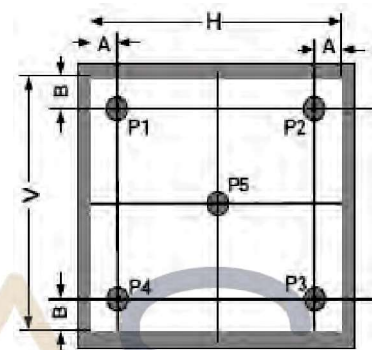

Figure a

Size :  $5" < S \leq 12.3"$  (see Figure b) H, V : Active area

Light spot size  $\varnothing = 5\text{mm}$  (BM-5) or  $\varnothing = 7.7\text{mm}$  (BM-7) 50cm distance or compatible distance from the LCD surface to detector lens.

test spot position : see Figure b.

measurement instrument : TOPCON's luminance meter BM-5 or BM-7 or compatible (see Figure c).

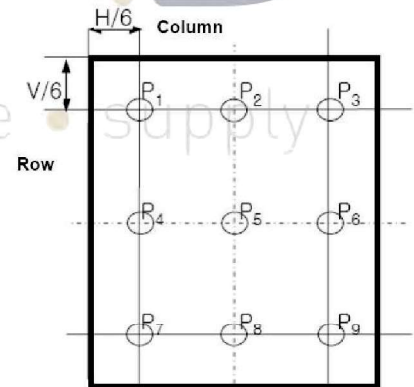

Figure b

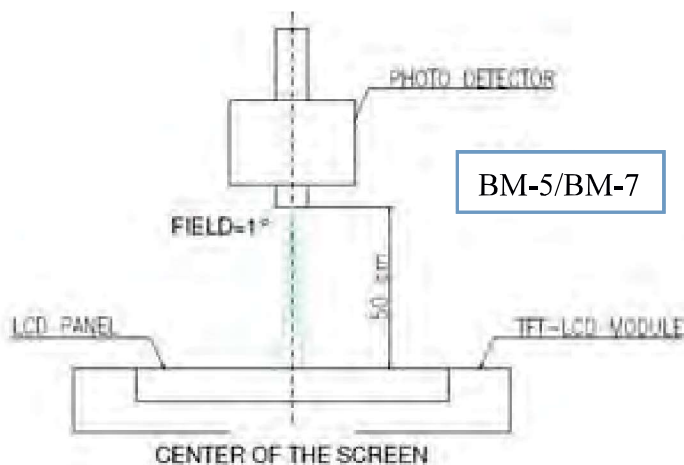
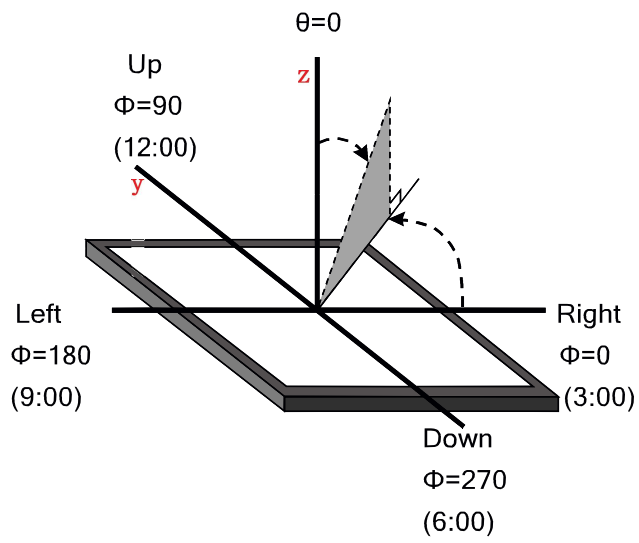

Figure c





FIG.3.The definition of viewing angle



MIDAS

design • manufacture • supply



## Environmental / Reliability Tests

No	Test Item	Condition	Remarks
1	High Temperature Operation	Ts= +85°C, 96hrs	Note 1 IEC60068-2-2, GB2423. 2-89
2	Low Temperature Operation	Ta= -30°C, 96hrs	Note 2 IEC60068-2-1 GB2423.1-89
3	High Temperature Storage	Ta= +85°C, 96hrs	IEC60068-2-2 GB2423. 2-89
4	Low Temperature Storage	Ta= -30°C, 96hrs	IEC60068-2-1 GB/T2423.1-89
5	High Temperature & Humidity Storage	Ta= +60°C, 90% RH max,96 hours	IEC60068-2-3 GB/T2423.3-2006
6	Thermal Shock (Non-operation)	-20°C 30 min ~ +60°C 30 min Change time: 5min, 30 Cycle	Start with cold temperature, end with high temperature IEC60068-2-14, GB2423.22-87
7	Electro Static Discharge (Operation)	C=150pF, R=330 Ω, 5 points/panel Air:±8KV, 5 times; Contact: ±4KV, 5 times; (Environment: 15°C ~ 35°C, 30% ~ 60%, 86Kpa ~ 106Kpa)	IEC61000-4-2 GB/T17626.2-1998
8	Vibration (Non-operation)	Frequency range: 10~55Hz, Stroke: 1.mm Sweep: 10Hz~55Hz~10Hz 2 hours for each direction of X .Y. Z. (package condition)	IEC60068-2-6 GB/T2423.5-1995
9	Shock (Non-operation)	60G 6ms, ± X, ±Y , ± Z 3 times for each direction	IEC60068-2-27 GB/T2423.5-1995
10	Package Drop Test	Height: 80 cm, 1 corner, 3 edges, 6 surfaces	IEC60068-2-32 GB/T2423.8-1995

- Note: 1. Ts is the temperature of panel's surface.  
2. Ta is the ambient temperature of sample.  
3. The size of sample is 5pcs.



# Mechanical Drawing

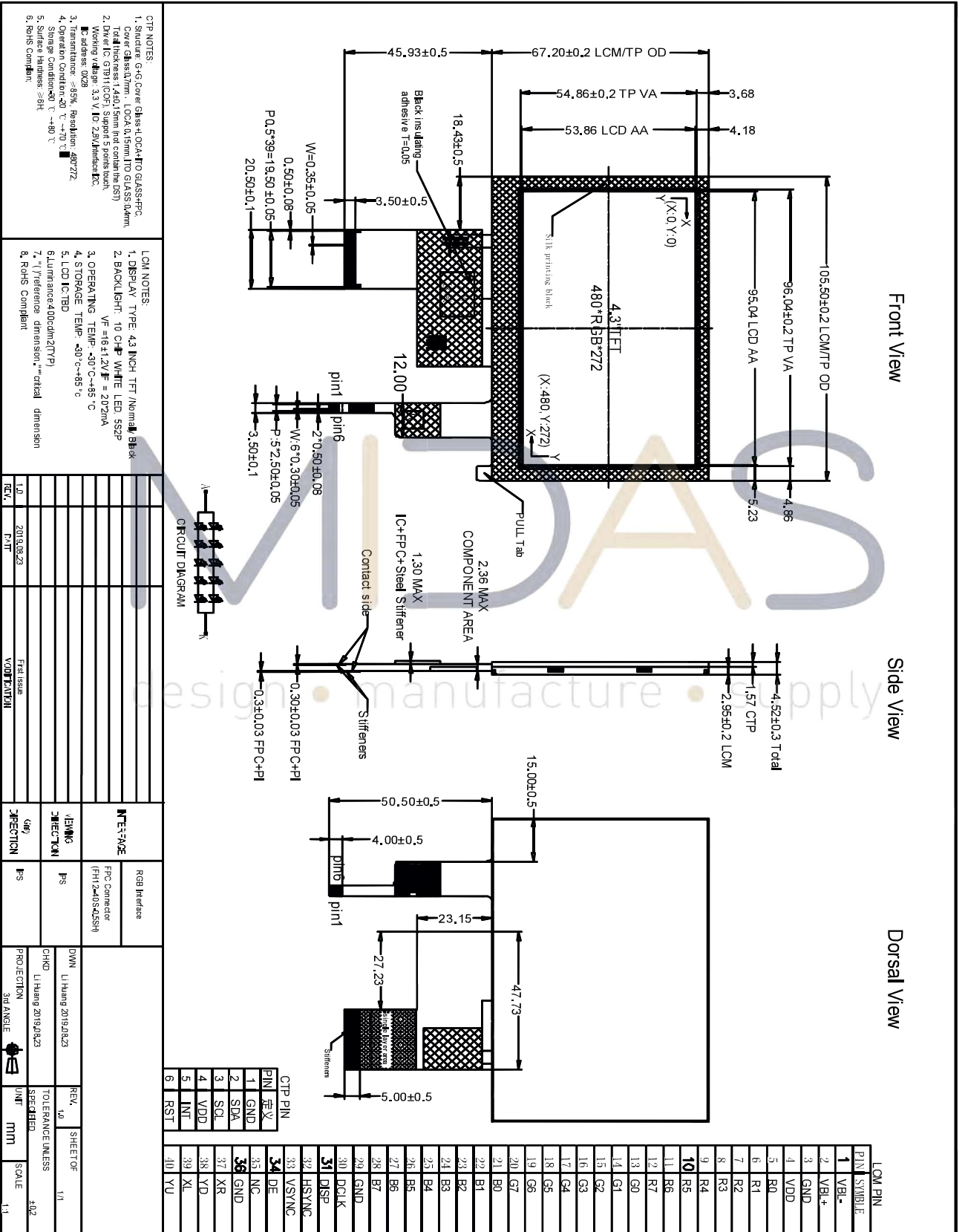

# TFT-LCD Module Inspection Criteria

## Scope

The incoming inspection standards shall be applied to TFT - LCD Modules (hereinafter Called "Modules") that supplied by Midas Displays.

## Incoming Inspection

The customer shall inspect the modules within twenty calendar days of the delivery date (the "inspection period") at its own cost. The result of the inspection (acceptance or rejection) shall be recorded in writing, and a copy of this writing will be promptly sent to The seller, If the results of the inspecting from buyer does not send to the seller within twenty Calendar days of the delivery date. The modules shall be regards as acceptance. Should the customer fail to notify the seller within the inspection period, the buyers Right to reject the modules shall be lapsed and the modules shall be deemed to have Been accepted by the buyer

## Inspection Sampling

- 3.1. Lot size: Quantity per shipment lot per model
- 3.2. Sampling type: Normal inspection, Single sampling
- 3.3. Inspection level: II
- 3.4. Sampling table: MIL-STD-105E
- 3.5. Acceptable quality level (AQL )  
Major defect: AQL=0.65 Minor defect: AQL=1.00

## Inspection Conditions

### 4.1 Ambient conditions:

- a. Temperature: Room temperature  $25 \pm 5^{\circ}\text{C}$
- b. Humidity:  $(60 \pm 10) \% \text{RH}$
- c. Illumination: Single fluorescent lamp non-directive (300 to 700 Lux)

### 4.2 Viewing distance

The distance between the LCD and the inspector's eyes shall be at least  $35 \pm 5$  cm.

### 4.3 Viewing Angle

U/D:  $45^{\circ} / 45^{\circ}$  , L/R:  $45^{\circ} / 45^{\circ}$



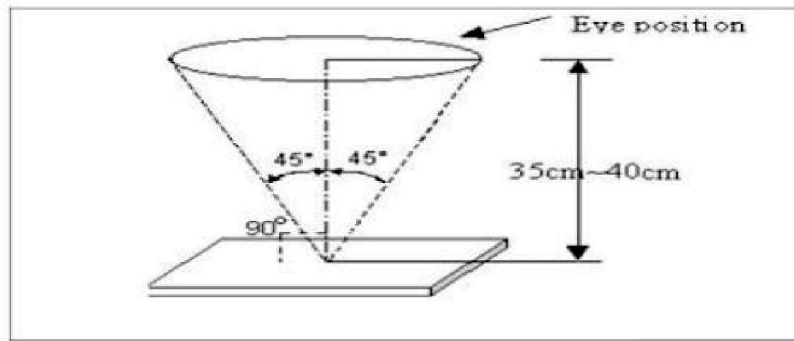

## Inspection Criteria

Defects are classified as major defects and minor defects according to the degree of Defectiveness defined herein.

### Major defect

Item No	Items to be inspected	Inspection Standard
5.1.1	All functional defects	1) No display 2) Display abnormally 3) Short circuit 4) line defect
5.1.2	Missing	Missing function component
5.1.3	Crack	Glass Crack

### Minor defect

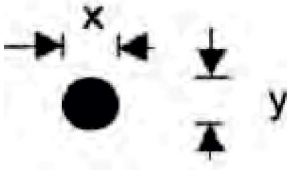
Item No	Items to be inspected	Inspection standard	
5.2.1	Spot Defect Including Black spot White spot Pinhole Foreign particle Polarizer dirt	For dark/white spot is defined $\varphi = (x+y) / 2$ 	
		Size $\varphi$ (mm)	Acceptable Quantity
		$\varphi \leq 0.2$	Ignore
		$0.2 < \varphi \leq 0.5$	3
		$0.5 < \varphi$	Not allowed

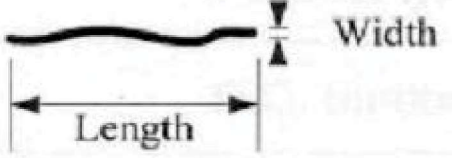
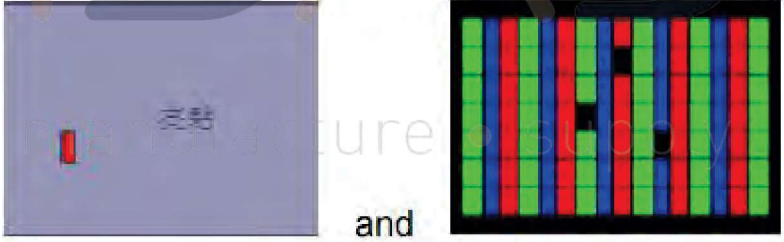
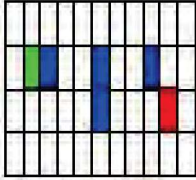

5.2.2	Line Defect Including Black line White line Scratch	Define:			
					
		Width(mm) Length(mm)		Acceptable Quantity	
		$W \leq 0.05$		Ignore	
		$0.05 < W \leq 0.1$ $L \leq 2.5$		3	
$0.1 < W$ , or $L > 2.5$		Not allowed			
5.2.3	Polarizer Dent/Bubble	Size $\phi$ (mm)		Acceptable Quantity	
		$\phi \leq 0.2$		Ignore	
		$0.2 < \phi \leq 0.3$		2	
		$0.3 < \phi \leq 0.5$		1	
		$0.5 < \phi$		Not allowed	
Total QTY		3			
5.2.4	Electrical Dot Defect	Bright and Black dot define:			
					
					
		Two Adjacent Dot			
		Inspection pattern: Full white, Full black, Red, green and blue screens			
Item		Acceptable Quantity			
		I	O	Note	
Black dot defect		2		$\phi \leq 0.15$ (5mm $\leq$ Distance)	
Bright dot defect		1			
Total Dot		1			

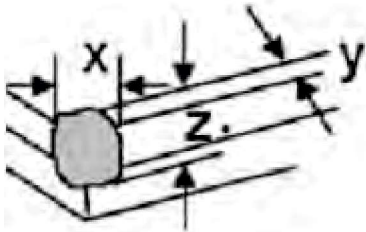
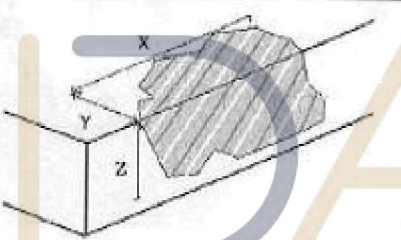

5.2.5	Glass defect	 <p><b>1. Corner Fragment:</b></p>	
		Size(mm)	Acceptable Quantity
		$X \leq 3\text{mm}$ $Y \leq 1\text{mm}$ $Z \leq T$	Ignore <b>T:</b> Glass thickness <b>X:</b> Length <b>Y:</b> Width <b>Z:</b> thickness
		<p><b>2. Side Fragment:</b></p> 	
		Size(mm)	Acceptable Quantity
		$X \leq 5.0\text{mm}$ $Y \leq 1\text{mm}$ $Z \leq T$	<b>T:</b> Glass thickness <b>X:</b> Length <b>Y:</b> Width <b>Z:</b> thickness



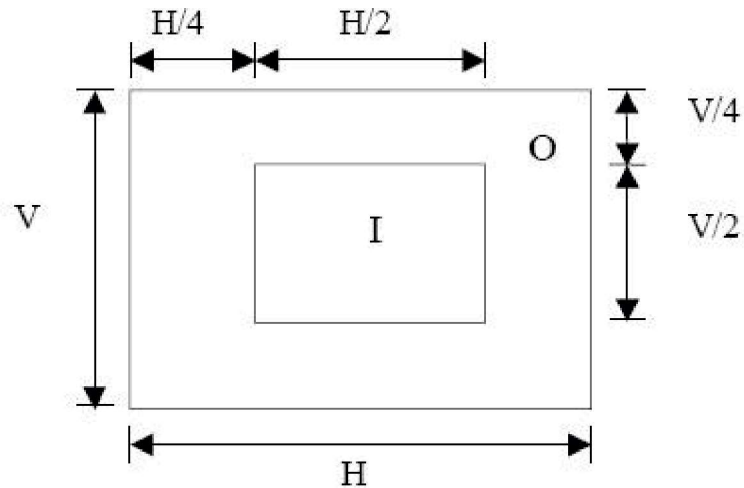

### I area & O area

- Note:
- 1). Dot defect is defined as the defective area of the dot area is larger than 50% of the dot area.
  - 2). The distance between two bright dot defects (red, green, blue, and white) should be larger than 15mm.
  - 3). The distance between black dot defects or black and bright dot defects should be more than 5mm apart.
  - 4). Polarizer bubble is defined as the bubble appears on active display area. The defect of polarizer bubble shall be ignored if the polarizer bubble appears on the outside of active display area.

### Mechanics specification

As for the outside dimension, weight of the modules, please refer to product specification  
For more details





## Precautions for Use of LCD modules

### Handling Precautions

- 1.1. The display panel is made of glass. Do not subject it to a mechanical shock by dropping it from a high place, etc.
- 1.2. If the display panel is damaged and the liquid crystal substance inside it leaks out, be sure not to get any in your mouth, if the substance comes into contact with your skin or clothes, promptly wash it off using soap and water.
- 1.3. Do not apply excessive force to the display surface or the adjoining areas since this may cause the color tone to vary.
- 1.4. The polarizer covering the display surface of the LCD module is soft and easily scratched. Handle this polarizer carefully.
- 1.5. If the display surface is contaminated, breathe on the surface and gently wipe it with a soft dry cloth. If still not completely clear, moisten cloth with one of the following solvents:
  - Isopropyl alcohol
  - Ethyl alcoholSolvents other than those mentioned above may damage the polarizer. Especially, do not use the following:
  - Water
  - Ketene
  - Aromatic solvents
- 1.6. Do not attempt to disassemble the LCD Module.
- 1.7. If the logic circuit power is off, do not apply the input signals.
- 1.8. To prevent destruction of the elements by static electricity, be careful to maintain an optimum work environment.
  - 1.8.1. Be sure to ground the body when handling the LCD Modules.
  - 1.8.2. Tools required for assembly, such as soldering irons, must be properly ground.
  - 1.8.3. To reduce the amount of static electricity generated, do not conduct assembly and other work under dry conditions.
  - 1.8.4. The LCD Module is coated with a film to protect the display surface. Be care when peeling off this protective film since static electricity may be generated.

### Storage Precautions

- 2.1. When storing the LCD modules, avoid exposure to direct sunlight or to the light of fluorescent lamps.
- 2.2. The LCD modules should be stored under the storage temperature range. If the LCD modules will be stored for a long time, the recommend condition is:  
Temperature : 0°C ~ 40°C Relatively humidity: ≤80%
- 2.3. The LCD modules should be stored in the room without acid, alkali and harmful gas.

### Transportation Precautions

The LCD modules should be no falling and violent shocking during transportation, and also should avoid excessive press, water, damp and sunshine.

