

MDT0700E3IH-LVDS	1024 x 600	LVDS Interface	TFT Module
Specification			
Version: 1		Date: 23/04/2019	
Revision			
1	21/04/2019	First issue	

Display Features			
Display Size	7.0"		
Resolution	1024 x 600		
Orientation	Landscape		
Appearance	RGB		
Logic Voltage	3.3V		
Interface	LVDS		
Brightness	500 cd/m ²		
Touchscreen	--		
Module Size	165.00 x 100.00 x 5.70 mm		
Operating Temperature	-20°C ~ +70°C		
Pinout	40 way FFC		Box Quantity
Pitch	0.5mm		Weight / Display

* - For full design functionality, please use this specification in conjunction with the EK79001HN+EK73215BCGA specification.(Provided Separately)

Display Accessories	
Part Number	Description

Optional Variants	
Appearances	Voltage



General Specifications

	Feature	Spec
Characteristics	Size	7 inch
	Resolution	1024(horizontal)*600(Vertical)
	Interface	LVDS
	Connect type	Connector
	Display Colors	16.7M
	Technology type	a-Si
	Pixel pitch (mm)	0.150*0.143
	Pixel Configuration	R.G.B.-Stripe
	Display Mode	Normally Black
	LCD Driver IC	EK79001HN+EK73215BCGA
	Viewing Direction	Full view
Mechanical	LCM (W x H x D) (mm)	165.00*100.00*5.70
	Active Area(mm)	154.21 x85.92
	With /Without TSP	Without TSP
	Weight (g)	TBD
	LED Numbers	30 LEDs

Note 1: Requirements on Environmental Protection: RoHs

Note 2: LCM weight tolerance: +/- 5%

design • manufacture • supply



Input/Output Terminals

LCD PIN-MAP

No.	Symbol	Description
1	VCOM	Common Voltage
2	VDD	Power Voltage for digital circuit
3	VDD	Power Voltage for digital circuit
4	NC	No connection
5	RESET	Global reset pin
6	STBYB	Standby mode Normally pulled high STBYB=1,normal operation STBYB=0,timing controller,source Driver will turn off,all output are High-Z
7	GND	Ground
8	RXIN0-	-LVDS differential data input
9	RXIN0+	+LVDS differential data input
10	GND	Ground
11	RXIN1-	-LVDS differential data input
12	RXIN1+	+LVDS differential data input
13	GND	Ground
14	RXIN2-	-LVDS differential data input
15	RXIN2+	+LVDS differential data input
16	GND	Ground
17	RXCLKIN-	-LVDS differential clock input
18	RXCLKIN+	+LVDS differential clock input
19	GND	Ground
20	RXIN3-	-LVDS differential data input
21	RXIN3+	+LVDS differential data input
22	GND	Ground
23	NC	No connection
24	NC	No connection
25	GND	Ground
26	NC	No connection
27	DIMO	Backlight CABC controller signal output
28	SELB	6bit/8bit mode select (Note 1)
29	AVDD	Power for Analog Circuit
30	GND	Ground
31	LED-	LED Cathode
32	LED-	LED Cathode



33	L/R	Horizontal inversion	(Note 2)
34	U/D	Vertical inversion	(Note 2)
35	VGL	Gate oFF Voltage	Power supply
36	NC	No connection	
37	NC	No connection	
38	VGH	Gate ON Voltage	
39	LED+	LED Anode	
40	LED+	LED Anode	

Note 1: if LVDS input data is 6bit,selb must be set to high;

if LVDS input data is 8bit,selb must be set to low;

Note 2: when L/R=0 set right to left scan direction

when L/R=1 set left to right scan direction

when U/D=0 set top to bottom scan direction

when U/D=1 set bottom to top scan direction

MIDAS

design • manufacture • supply



Absolute Maximum Rating

Item	Symbol	MIN	Typ	MAX	Unit	Remark
Supply Voltage	VDD	-0.3	-	5	V	-
Operating Temperature	TOPR	-20	-	70	°C	-
Storage Temperature	TSTG	-30	-	80	°C	-

Electrical Characteristics

Driving TFT LCD Panel

Item	Symbol	MIN	TYP	MAX	Unit	Remark
Power supply for LCD	VDD	3.0	3.3	3.6	V	
	AVDD	9.0	9.8	10.5	V	
	VGH	16.0	18.0	20	V	
	VGL	-7.5	-6.0	-5.0	V	
	VCOM	2.9	3.25	3.5	V	

LED Driving Conditions

Item	Symbol	MIN	TYP	MAX	Unit	Remark
Forward Current	I _F	-	200	-	mA	
Forward Voltage	V _F	9	9.6	10.2	V	
Backlight Power consumption	W _{BL}	-	1.92	-	W	
LED Lifetime		-	50000	-	Hrs	

Note 1: Each LED: I_F =20 mA, V_F =3.2+/-0.2V.

Note 2: Optical performance should be evaluated at Ta=25°C only.

Note 3: If LED is driven by high current, high ambient temperature & humidity condition. The life Time of LED will be reduced. Operating life means brightness goes down to 50% initial brightness. Typical operating life time is estimated data.

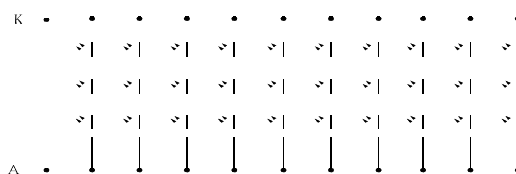

Figure: LED connection of backlight(Constant Current)



Interface Timing

Power sequence

a. Power on:

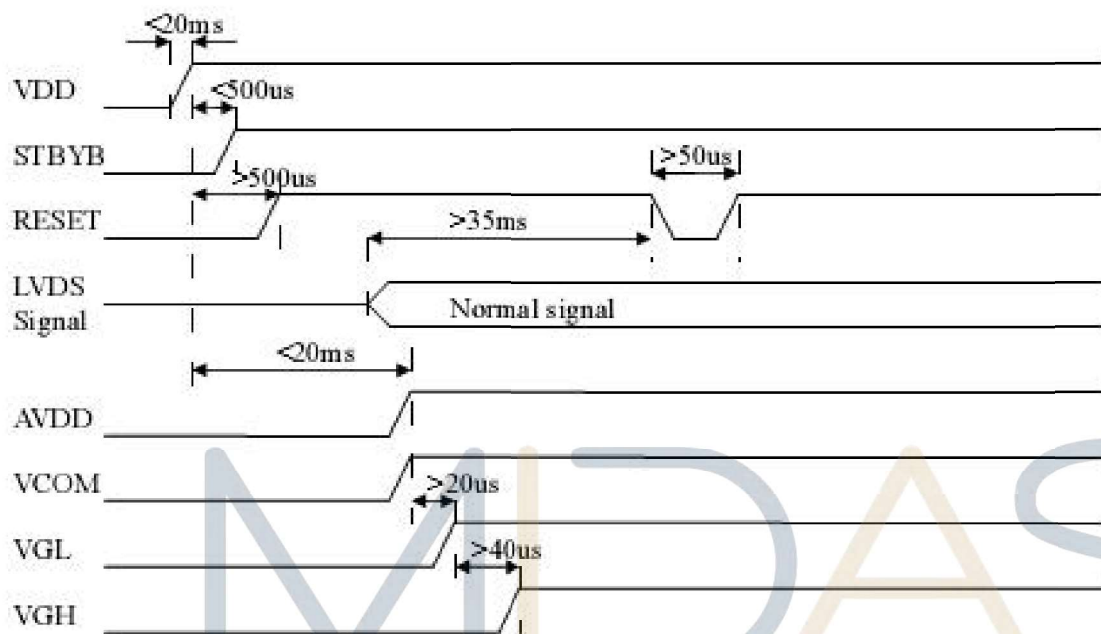

b. Power off:

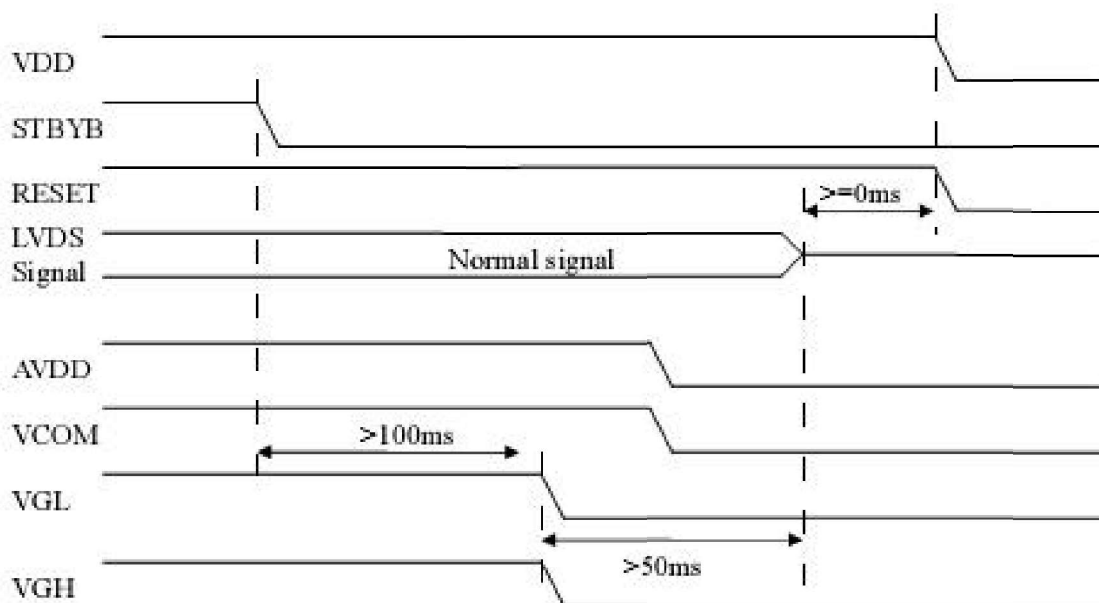

3.3.3. DC Electrical Characteristics

Parameter	Symbol	Values			Unit	Remark
		Min.	Typ.	Max.		
Differential input high Threshold voltage	R_{xVTH}	-	-	+0.1	V	$R_{xVCM}=1.2V$
Differential input low Threshold voltage	R_{xVTL}	-0.1	-	-	V	
Input voltage range (singled-end)	R_{xVIN}	0	-	2.4	V	
Differential input common mode voltage	R_{xVCM}	$ V_{ID} /2$	-	$2.4- V_{ID} /2$	V	
Differential voltage	$ V_{ID} $	0.2	-	0.6	V	
Differential input leakage current	$R_{V_{ILZ}}$	-10	-	+10	μA	

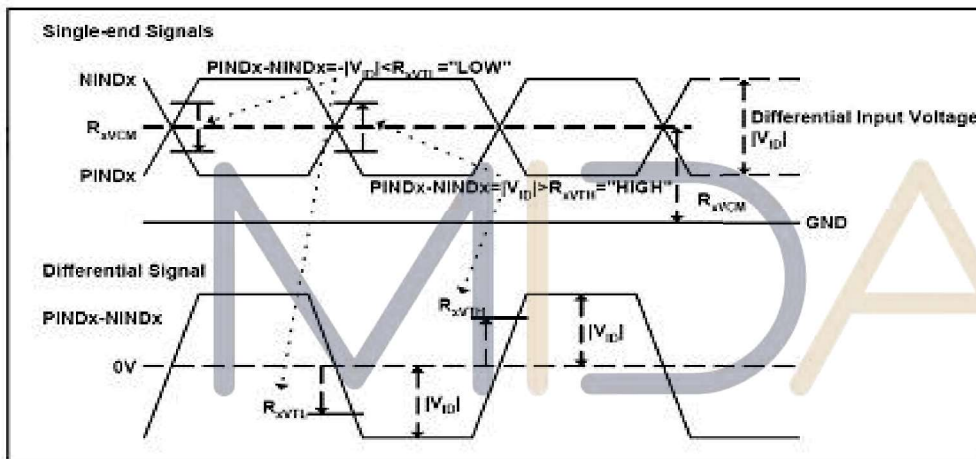

3.3.4. Timing

Item	Symbol	Values			Unit	Remark
		Min.	Typ.	Max.		
Clock Frequency	fclk	40.8	51.2	67.2	MHz	Frame rate =60Hz
Horizontal display area	thd	1024			DCLK	
HS period time	th	1114	1344	1400	DCLK	
HS Blanking	thb	90	320	376	DCLK	
Vertical display area	tvd	600			H	
VS period time	tv	610	635	800	H	
VS Blanking	thb	10	35	200	H	

3.3.5. Data Input Format

6bit LVDS input

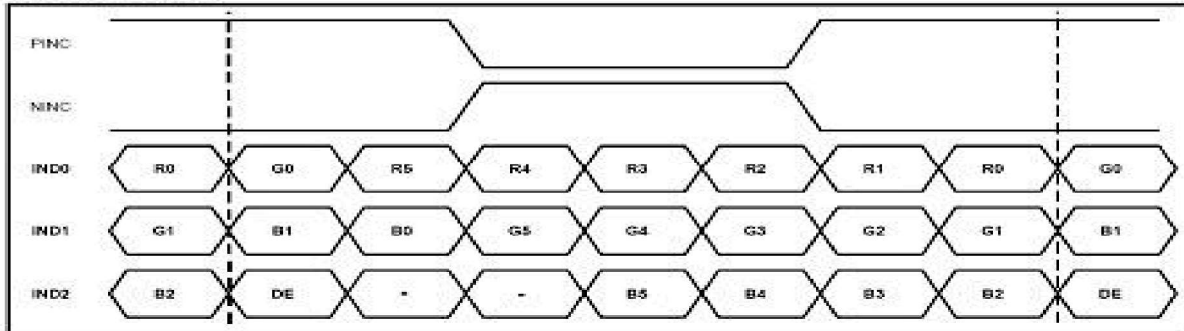

8bit LVDS input



Note: Support DE timing mode only, SYNC mode not supported.

MIDAS

design • manufacture • supply



Optical Characteristics

Items	Symbol	Condition	Min.	Typ.	Max.	Unit	Remark	Note
Response time	Tr+Tf	-	-	30	40	ms	FIG.1	Note4
Contrast Ratio	CR		500	800	-	-	FIG.2	Note1
Surface luminance	LV	$\theta = 0^\circ$	-	500	-	cd/m2	FIG.2	Note2
Luminance uniformity	Yu	$\theta = 0^\circ$	70	-	-	%	FIG.2	Note3
NTSC	-	$\theta = 0^\circ$	-	50	-	%	FIG.2	Note5
Viewing angle	θ_T	Center CR \geq 10	-	85	-	deg	FIG.3	Note6
	θ_B		-	85	-	deg	FIG.3	
	θ_L		-	85	-	deg	FIG.3	
	θ_R		-	85	-	deg	FIG.3	
Chromaticity	Red	R_x	TBD	TBD	TBD	-	FIG.2 CIE1931	Note5
		R_y	TBD	TBD	TBD	-		
	Green	G_x	TBD	TBD	TBD	-		
		G_y	TBD	TBD	TBD	-		
	Blue	B_x	TBD	TBD	TBD	-		
		B_y	TBD	TBD	TBD	-		
	White	W_x	TBD	TBD	TBD	-		
		W_y	TBD	TBD	TBD	-		

Note1. Definition of contrast ratio

Contrast ratio(Cr) is defined mathematically by the following formula. For more information see FIG.2.

$$\text{Contrast ratio} = \frac{\text{Luminance measured when LCD on the "White" state}}{\text{Luminance measured when LCD on the "Black" state}}$$

For contrast ratio, Surface Luminance, Luminance uniformity and CIE, the testing data is based on TOPCON's BM-5 or BM-7 photo detector or compatible.

Note2. Definition of surface luminance.

Surface luminance is the luminance with all pixels displaying white. For more information see FIG.2.

L_v = Average Surface Luminance with all white pixels ($P_1, P_2, P_3, \dots, P_n$)

Note3. Definition of luminance uniformity

The luminance uniformity in surface luminance is determined by measuring luminance at each test position 1 through n, and then dividing the maximum luminance of n points luminance by minimum luminance of n points luminance. For more information see FIG.2.

$$YU = \frac{\text{Minimum surface luminance with all white pixels } (P_1, P_2, P_3, \dots, P_n)}{\text{Maximum surface luminance with all white pixels } (P_1, P_2, P_3, \dots, P_n)}$$

Note4. Definition of response time

The response time is defined as the LCD optical switching time interval between "White" state and "Black" state. Rise time (T_r) is the time between photo detector output intensity changed from 90% to 10%. And



fall time (Tf) is the time between photo detector output intensity changed from 10% to 90%.

For additional information see FIG1.

Note5. Definition of color chromaticity (CIE1931)

CIE (x,y) chromaticity, The x,y value is determined by screen active area center position P5. For more information see FIG.2.

Note6. Definition of viewing angle

Viewing angle is the angle at which the contrast ratio is greater than 10. Angles are determined for the horizontal or x axis and the vertical or y axis with respect to the z axis which is normal to the LCD surface. For more information see FIG.3.

For viewing angle and response time testing, the testing data is base on Autronic-Melchers' s ConoScope or DMS series Instruments or compatible.

FIG.1. The definition of response Time

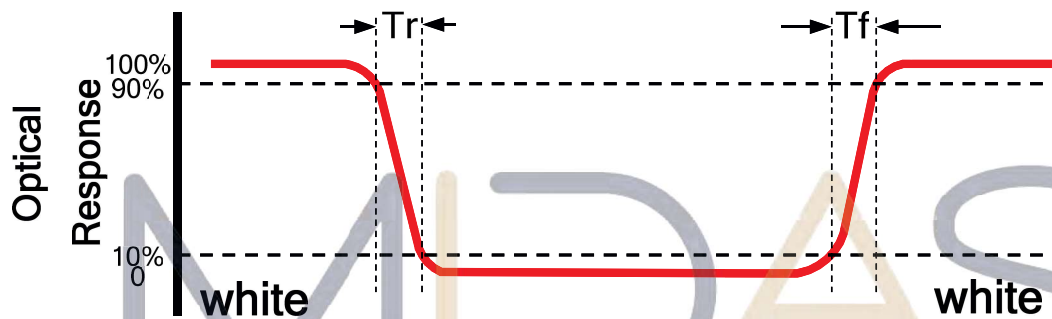

FIG.2. Measuring method for contrast ratio, surface luminance,

luminance uniformity, CIE (x,y) chromaticity

Size : $S \leq 5''$ (see Figure a) A : 5 mm B : 5 mm
H,V : Active area

Light spot size $\varnothing = 5\text{mm}$ (BM-5) or $\varnothing = 7.7\text{mm}$ (BM-7) 50cm distance or compatible distance from the LCD surface to detector lens.

test spot position : see Figure a.

measurement instrument : TOPCON's luminance meter BM-5 or BM-7 or compatible (see Figure c).

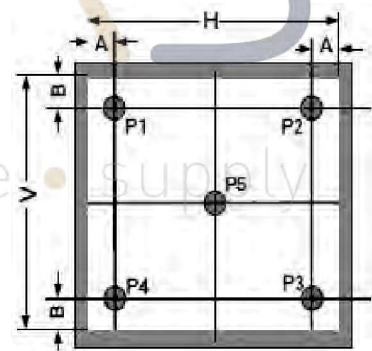

Figure a

Size : $5'' < S \leq 12.3''$ (see Figure b) H,V : Active area

Light spot size $\varnothing = 5\text{mm}$ (BM-5) or $\varnothing = 7.7\text{mm}$ (BM-7) 50cm distance or compatible distance from the LCD surface to detector lens.

test spot position : see Figure b.

measurement instrument : TOPCON's luminance meter BM-5 or BM-7 or compatible (see Figure c).

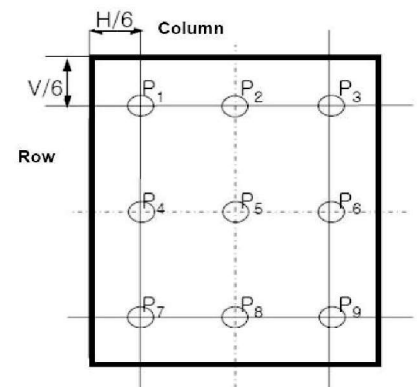

Figure b



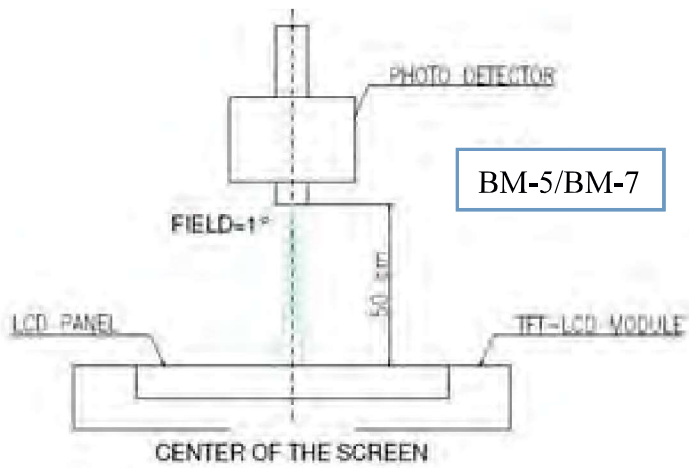
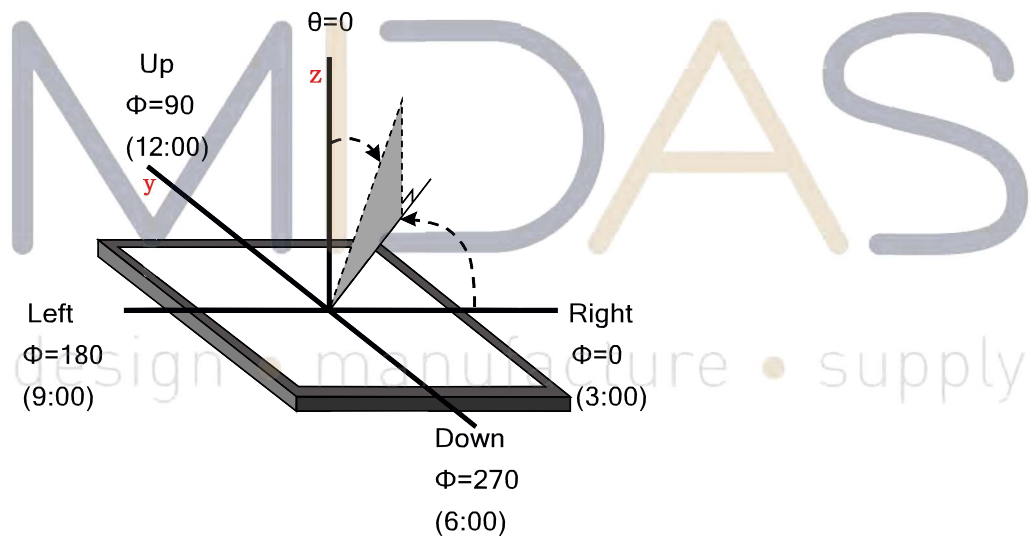

Figure c

FIG.3.The definition of viewing angle



Environmental / Reliability Tests

No	Test Item	Condition	Remarks
1	High Temperature Operation	Ts= +70°C, 96hrs	Note 1 IEC60068-2-2, GB2423. 2-89
2	Low Temperature Operation	Ta= -20°C, 96hrs	Note 2 IEC60068-2-1 GB2423.1-89
3	High Temperature Storage	Ta= +80°C, 120hrs	IEC60068-2-2 GB2423. 2-89
4	Low Temperature Storage	Ta= -30°C, 120hrs	IEC60068-2-1 GB/T2423.1-89
5	High Temperature & Humidity Storage	Ta= +60°C, 90% RH max, 120 hours	IEC60068-2-3 GB/T2423.3-2006
6	Thermal Shock (Non-operation)	-20°C 30 min ~ +60°C 30 min Change time: 5min, 30 Cycle	Start with cold temperature, end with high temperature IEC60068-2-14, GB2423.22-87
7	Electro Static Discharge (Operation)	C=150pF, R=330 Ω, 5 points/panel Air:±8KV, 5 times; Contact: ±4KV, 5 times; (Environment: 15°C ~ 35°C, 30% ~ 60%, 86Kpa ~ 106Kpa)	IEC61000-4-2 GB/T17626.2-1998
8	Vibration (Non-operation)	Frequency range: 10~55Hz, Stroke: 1.mm Sweep: 10Hz~55Hz~10Hz 2 hours for each direction of X .Y. Z. (package condition)	IEC60068-2-6 GB/T2423.5-1995
9	Shock (Non-operation)	60G 6ms, ± X, ±Y , ± Z 3 times for each direction	IEC60068-2-27 GB/T2423.5-1995
10	Package Drop Test	Height: 80 cm, 1 corner, 3 edges, 6 surfaces	IEC60068-2-32 GB/T2423.8-1995

- Note: 1. Ts is the temperature of panel's surface.
2. Ta is the ambient temperature of sample.
3. The size of sample is 5pcs.



Mechanical Drawing

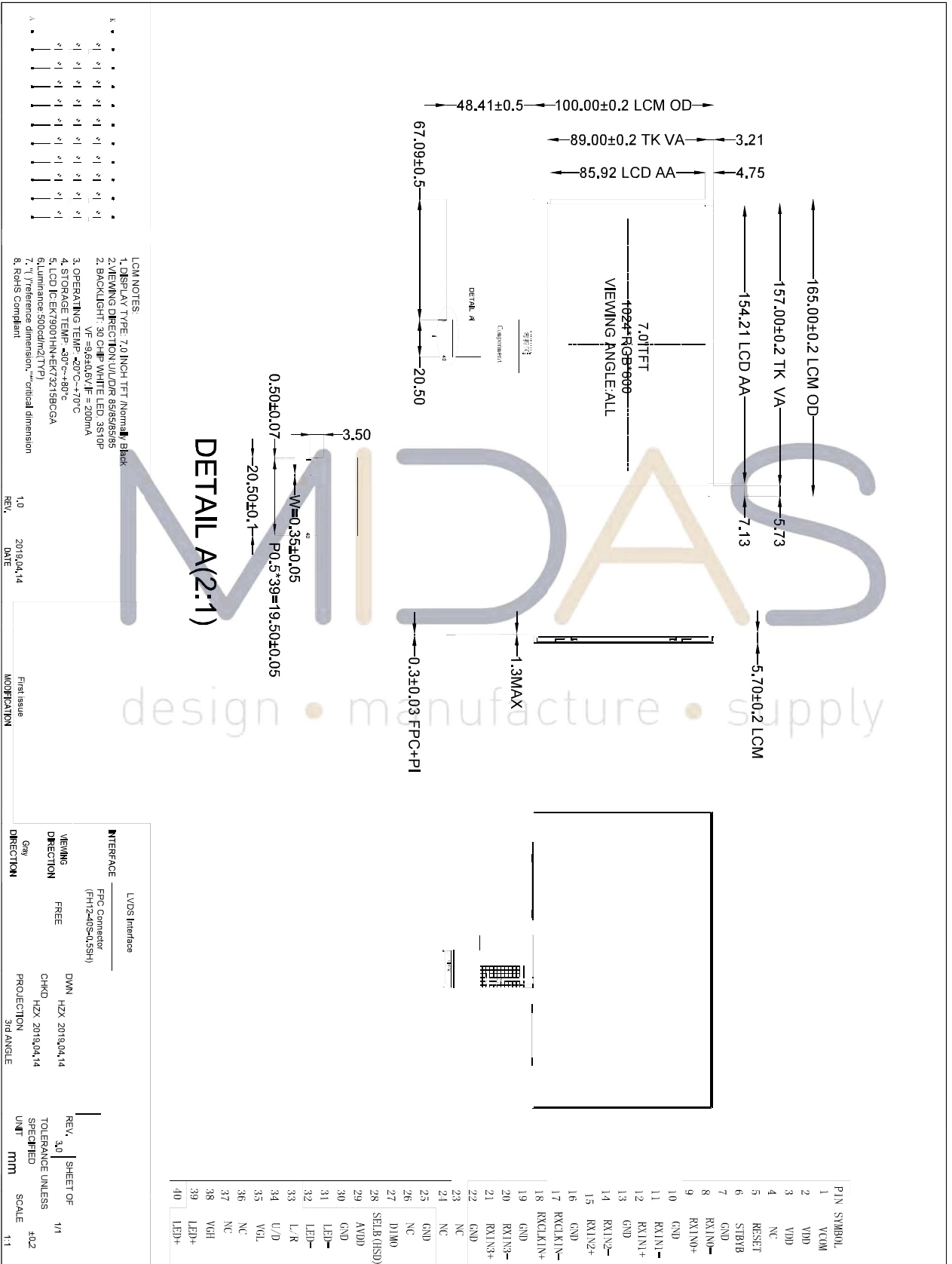

TFT-LCD Module Inspection Criteria

Objective

The TFT criterion is set to formalize the TFT quality standards with reference to customer for inspection.

Scope

The criterion is applicable to $5'' \leq S < 10''$ TFT products (Include TFT , TFT+RTP or TFT+CTP) manufactured by TFC.

Tools for Inspection

Tester, Calipers, Multi-meter, Anti-static wrist straps, Finger Cots, Desk Lamps, etc.

Sampling Plan and Reference Standards

Sampling plan:

Refer to GB/T2828.1-2012/ISO2859-1:1999 //MIL-STD-105E

AQL: level II; normal:

- 1) MA=0.40
- 2) MI=0.65

IPC-A-610 Acceptability of Electronic Assemblies.

Inspection Conditions and Inspection Reference

Cosmetic inspection with naked eyes:

- 1) Temperature: $23 \pm 5^{\circ}\text{C}$; relative humidity: 45~75%RH
- 2) Illumination: 500lux~1000lux
- 3) Distance: $30\text{cm} \pm 5$ from the inspector's naked eyes to the LCD panel.
- 4) View angle: within 45° from perpendicular to LCM surface (view direction and special parameters refer to production specification).



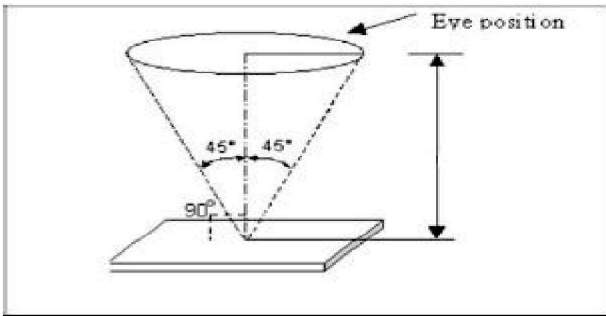

Definition

Area definition

A area: Active area (AA area)

B area: Viewing area (VA area)

C area: non-view area (out of B area)

Any cosmetic defect which do not affect product quality and customer assembling in C area, it's Acceptable. (The dimension is defined on the drawings)

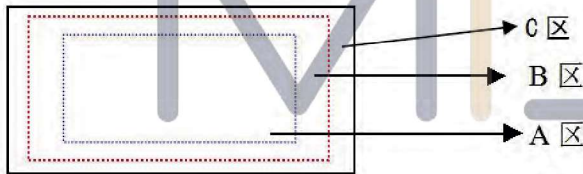

Test condition: refer to product specification

Defect type:

A area defect type:

Line defect (scratch, soft flocks, fibre) 、 dot defect (white dot, black dot, same color dot, different color dot, bubble) , stain, pin-hole, light leak, scratch.

B area defect type:

Broken, crack/chipping, FPC defect

Undefined items or other special items, refer to mutual agreement and limited sample by customer.

Test condition: refer to product specification.



Defects and Acceptance Standards

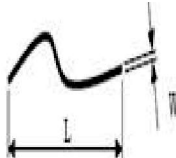
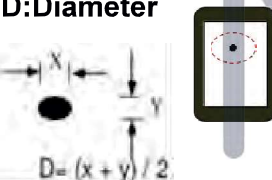
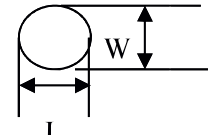

Appearance inspection

Dot/line defect

Defect	5≤S < 10"	Accepted standard	MAJ	MIN
S/C , line defect W:width L:length 	$W \leq 0.05\text{mm}$	Accept		√
	$0.05\text{mm} < W \leq 0.1\text{mm}$, $L \leq 8\text{mm}$ quantity ≤ 3 distance > 10mm	Accept		√
	$W > 0.1\text{mm}$ $L > 8\text{mm}$	Reject		√
Dot defect (black/white spot, foreign objects etc) D:Diameter 	$D \leq 0.15\text{mm}$	Accept		√
	$0.15\text{mm} < D \leq 0.30\text{mm}$ quantity ≤ 3 distance > 10mm	Accept		√
	$D > 0.30\text{mm}$	Reject		√
Polarizer with air bubble convex-concave dots or dent defect  $d = (w+l)/2$	$D \leq 0.20\text{mm}$	Accept		√
	$0.20\text{mm} < D \leq 0.5\text{mm}$ quantity ≤ 2	Accept		√
	$0.50\text{mm} < D \leq 0.8\text{mm}$ quantity ≤ 1	Accept		√
	$D > 0.8\text{mm}$	Reject		√

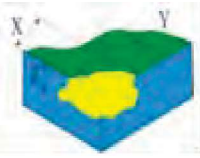

Chip and Crack

Defect	$5 \leq S < 10''$	Accepted standard	MAJ	MIN
LENS chip 	$X \leq 0.3\text{mm}, Y \leq 0.4\text{mm},$ one side ≤ 1	Accept		√
	$X > 0.3\text{mm}, Y > 0.4\text{mm}$	Reject		√
Sensor chip	Not affect ITO line, not lengthen, function test is OK. And be non-visual after attaching Lens.	Accept		√
	Affect ITO line and be visual.	Reject		√
Glass crack 	Glass crack.	Reject		√

Attaching defect (kapton tape/protective film)

Defect	Description	Accepted standard	MAJ	MIN
High temperature kapton tape	Kapton tape attached on FPC doesn't meet the criterion of drawing.	Reject		√
Protective film	Clean、attaching flat、no shifting	Accept		√

TFT defects and Inspection Criterion

Function items





Defects	Inspection Criterion	Pictures	Inspection method/tools	Defect category
No display /function	shows no picture/display in normal connected situation. ->Rejected		Naked eyes/ testers	MA
Missing segment	Shows missing lines in normal display.->Rejected		Naked eyes/ testers	MA



Image retention (sticking)	The previous picture stays in the next picture. Disappear time <10s, OK; time>10s, NG		Naked eyes/ testers	MA
Flicker	Not accepted	/	Naked eyes/ testers	MA
Display abnormal	Not accepted		Naked eyes/ testers	MA
Display dim/bright	Refer to bright value definition	/	Naked eyes/ BM-7	MA
Contrast	Refer to SPEC	/	Naked eyes/ BM-7	MA
White/ black dot White/ black speckle	Refer to dot criterion	/	Naked eyes	MI

LCD pixel defect(defect category: MI)

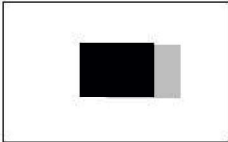
Item	Inspection criterion
Size	$5 \leq S < 10''$
Pixel defect(RGB dot)	2
2 connected bright pixel dot	0
3 connected bright pixel dot or more	0
Bright pixel dot quantity	2
Random dark pixel dot quantity	3



Item	Inspection criterion
2 connected pixel dark dot	1
3 connected pixel dark dot or more	0
Dark pixel dot quantity	4
Multi-bright pixel dot	ND 5% hidden, OK
<p>Remark: 2 bright pixel dots distance $DS \geq 15mm$ 2 dark pixel dots distance $DS \geq 5mm$</p> <p>1) Bright pixel dot: Power on TFT and RGB dot in black display</p> <p>2) Dark pixel dot: Power on TFT and gray or black dot in RGB display</p> <p>3) Multi-bright pixel dot: Power on TFT and fluorescent tiny dot in black display(only visible in black display)</p>	

Others

Some defect items are not defined in this document, obey to final negotiation between customer and manufacturer or sign limit sample.

If the final goods include FPC/PCB, inspection criterion refers to IPC-610, Level 2.

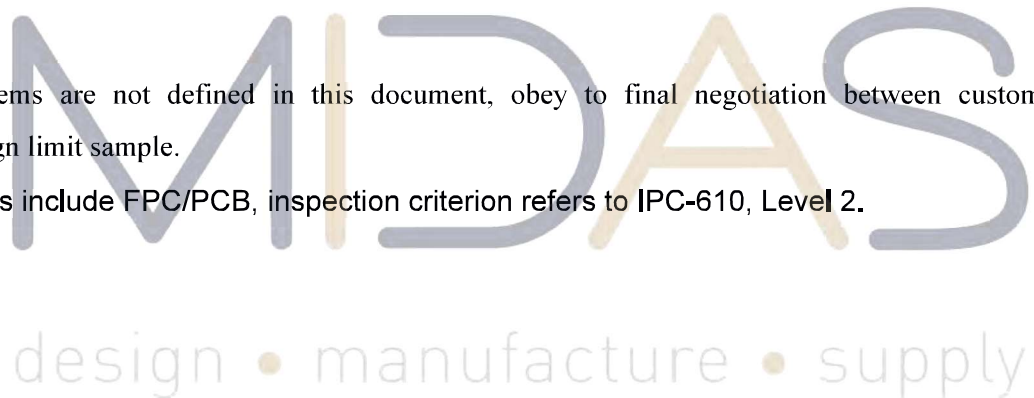

Precautions for Use of LCD modules

Handling Precautions

- 1.1. The display panel is made of glass. Do not subject it to a mechanical shock by dropping it from a high place, etc.
- 1.2. If the display panel is damaged and the liquid crystal substance inside it leaks out, be sure not to get any in your mouth, if the substance comes into contact with your skin or clothes, promptly wash it off using soap and water.
- 1.3. Do not apply excessive force to the display surface or the adjoining areas since this may cause the color tone to vary.
- 1.4. The polarizer covering the display surface of the LCD module is soft and easily scratched. Handle this polarizer carefully.
- 1.5. If the display surface is contaminated, breathe on the surface and gently wipe it with a soft dry cloth. If still not completely clear, moisten cloth with one of the following solvents:
 - Isopropyl alcohol
 - Ethyl alcoholSolvents other than those mentioned above may damage the polarizer. Especially, do not use the following:
 - Water
 - Ketene
- 1.6. Do not attempt to disassemble the LCD Module.
- 1.7. If the logic circuit power is off, do not apply the input signals.
- 1.8. To prevent destruction of the elements by static electricity, be careful to maintain an optimum work environment.
 - 1.8.1. Be sure to ground the body when handling the LCD Modules.
 - 1.8.2. Tools required for assembly, such as soldering irons, must be properly ground.
 - 1.8.3. To reduce the amount of static electricity generated, do not conduct assembly and other work under dry conditions.
 - 1.8.4. The LCD Module is coated with a film to protect the display surface. Be care when peeling off this protective film since static electricity may be generated.

Storage Precautions

- 2.1. When storing the LCD modules, avoid exposure to direct sunlight or to the light of fluorescent lamps.
- 2.2. The LCD modules should be stored under the storage temperature range. If the LCD modules will be stored for a long time, the recommend condition is:
Temperature : 0°C ~ 40°C Relatively humidity: ≤80%
- 2.3. The LCD modules should be stored in the room without acid, alkali and harmful gas.

Transportation Precautions

The LCD modules should be no falling and violent shocking during transportation, and also should avoid excessive press, water, damp and sunshine.

