



# EV171A-J-00A

## Small, Universal Input Non-Isolated Off-Line Regulator With Improved EMI Performance Evaluation Board

### DESCRIPTION

The EV171A-J-00A Evaluation Board is designed to demonstrate the capabilities of the MP171A. The MP171A is a primary-side constant voltage regulator, which provides accurate constant voltage (CV) regulation without opto-coupler. It supports Buck, Buck-Boost, Boost and Flyback topologies.

The EV171A-J-00A Evaluation Board is designed as Buck application. It typically drives 5V/50mA load from 85VAC to 265VAC input.

The EV171A-J-00A has an excellent efficiency and meets class3 (2kV) IEC61000-4-5 surge immunity and EN55022 conducted EMI requirements. The radiation emission performance gets improved compared with the MP171. The MP171A features various protections, including thermal shutdown (TSD), VCC under-voltage lockout (UVLO), over-load protection (OLP), short-circuit protection (SCP), and open loop detection.

The MP171A is available in TSOT23-5 and SOIC-8 packages.

### ELECTRICAL SPECIFICATION

Parameter	Symbol	Value	Units
Input Voltage	$V_{IN}$	85 to 265	VAC
Output Voltage	$V_{OUT}$	5	V
Output Current	$I_{OUT}$	50	mA

### FEATURES

- Primary-Side Non-Isolated CV Control
- Integrated 700V MOSFET
- <100mW No-Load Power Consumption
- Good EMI Performance
- Limited Maximum Frequency
- Multiple Protections: SCP, OLP, Open Loop Detection, TSD, and VCC UVLO
- Low Cost and Simple External Circuit

### APPLICATIONS

- Home Appliances, White Goods, and Consumer Electronics
- Industrial Controls
- Standby Power

All MPS parts are lead-free, halogen-free, and adhere to the RoHS directive. For MPS green status, please visit the MPS website under Quality Assurance. "MPS", the MPS logo, and "Simple, Easy Solutions" are trademarks of Monolithic Power Systems, Inc. or its subsidiaries.



**Warning:** Although this board is designed to satisfy safety requirements, the engineering prototype has not been agency approved. Therefore, all testing should be performed using an isolation transformer to provide the AC input to the prototype board.

**EV171A-J-00A EVALUATION BOARD**



(L x W x H) 17mm x 23mm x 17mm

Board Number	MPS IC Number
EV171A-J-00A	MP171AGJ

### EVALUATION BOARD SCHEMATIC

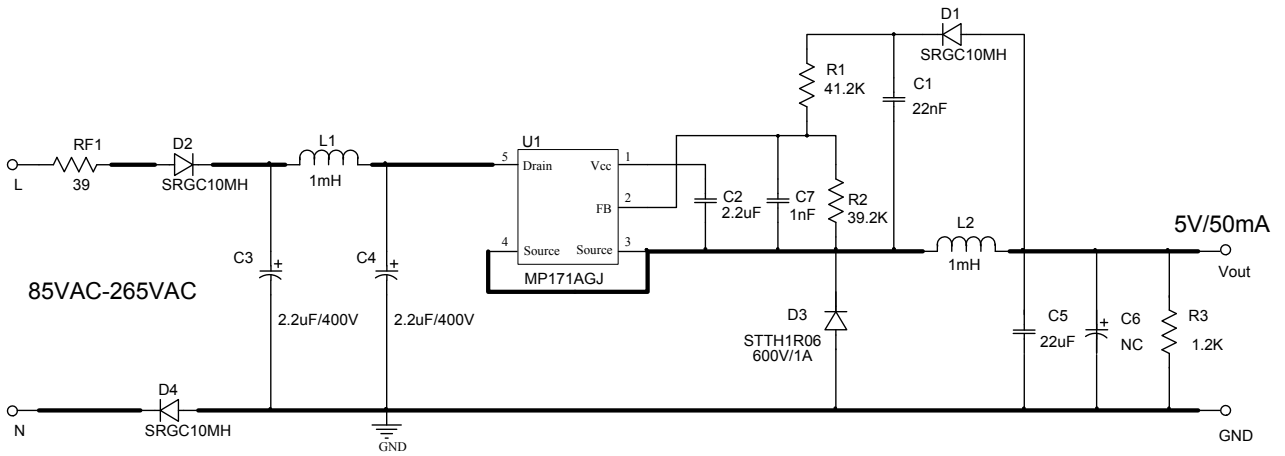

Figure 1: Schematic

PCB LAYOUT (SINGLE-SIDED)

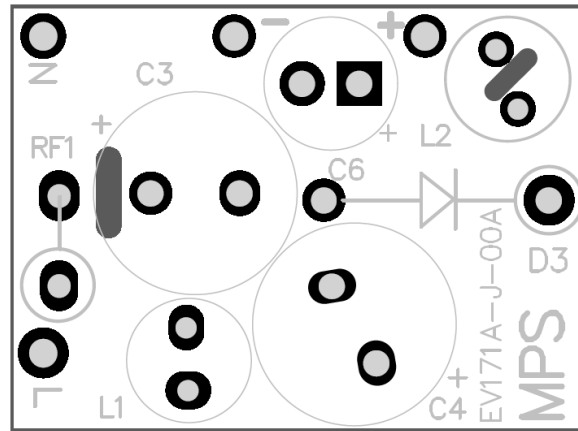

Figure 2: Top Layer

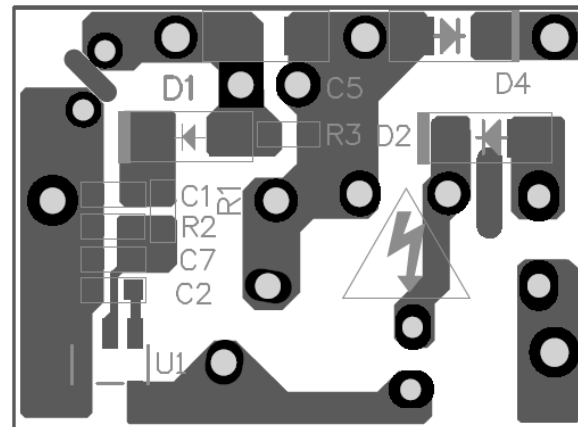

Figure 3: Bottom Layer

**BILL OF MATERIALS**

Qty	Ref	Value	Description	Package	Manufacture	Manufacture_PN
1	C1	22nF	Ceramic Capacitor; 16V; X7R	0603	muRata	GRM188R71C223KA01 D
1	C2	2.2μF	Ceramic Capacitor; 10V; X7R	0603	muRata	GRM188R71A225KE15 D
2	C3, C4	2.2μF	Electrolytic Capacitor; 400V	DIP	Rubycon	400LLE2R2MEFC
1	C5	22μF	Ceramic Capacitor; 25V; X5R	1206	muRata	GRM31CR61E226KE1 5
1	C7	1nF	Ceramic Capacitor; 50V; X7R	0603	SUMSUNG	C10B102KBNC
3	D1, D2, D4	SRGC10MH	Diode; 1000V; 1A	1206	Mexmega	SRGC10MH
1	D3	STTH1R06	Diode; 600V; 1A	DO-41	ST	STTH1R06
1	L1	1mH	Inductor; 17.4Ω; 100mA	DIP	Any	CKL0410-102
1	L2	1mH	Inductor; 6Ω; 250mA	DIP	Wurth	7447462102
1	R1	41.2K	Film Resistor; 1%	0603	Yageo	RC0603FR-0741K2L
1	R2	39.2K	Film Resistor; 1%	0603	Yageo	RC0603FR-0739K2L
1	R3	1.2K	Film Resistor; 1%	0603	Yageo	RC0603FR-071K2L
1	RF1	39	Fuse Resistor; 5%; 1W	DIP	Yageo	FKN1WSJT-50-39R
1	U1	MP171A	Buck Regulator	TSOT23-5	MPS	MP171AGJ

## **CIRCUIT DESCRIPTION**

The EV171A-J-00A is configured in a buck topology to demonstrate the performance of the MP171A. The MP171A is a primary side regulator which provides accurate constant voltage. It simplifies the schematic and minimizes the BOM cost.

RF1 is used to protect circuit from component failure or some excessive short events. It can also restrain the inrush current.

C3, L1 and C4 compose CLC filter to meet the conducted EMI standard EN55022. C3 and C4 are also used for energy storage and protecting against line surge.

With RF1, C3 and C4, the EV171A-J-00A meets calss3 (2kV) IEC61000-4-5 surge immunity standard.

C1 is the sample-hold capacitor used for reflecting output voltage. R1 and R2 are resistor divider for detecting output voltage by sampling voltage on C1.

D3 is the freewheeling diode. For universal voltage applications, use a diode with a 600V reverse block voltage. Fast recovery diode or ultra fast diode is recommended for better efficiency and reliable operation.

C5 is the output capacitors for 5V output. R3 is dummy load to lower the output voltage of 5V rail at no load condition.

### EVB TEST RESULTS

Performance waveforms are tested on the evaluation board.

$V_{IN}=230V_{AC}$ ,  $V_{OUT}=5V$ ,  $I_{OUT}=50mA$ ,  $T_A=26^{\circ}C$ , unless otherwise noted.

**Thermal**  
 $V_{IN}=85V_{AC}$

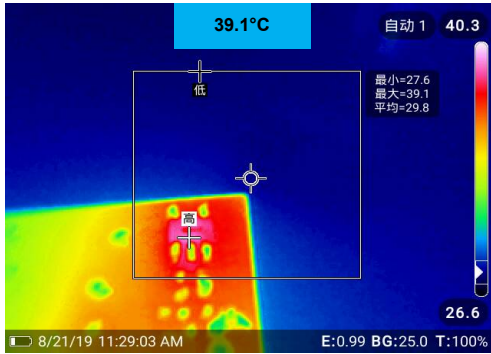

**Thermal**  
 $V_{IN}=265V_{AC}$

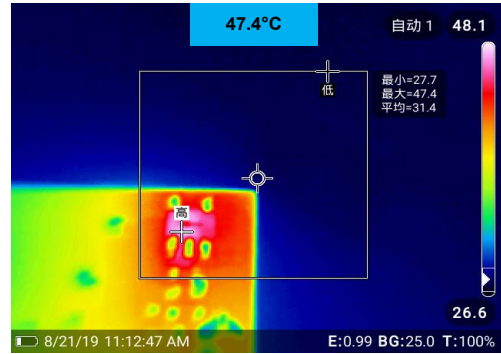

**CE Performance- L Line**

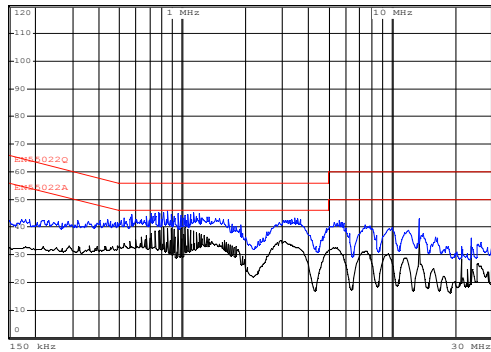

**CE Performance- N Line**

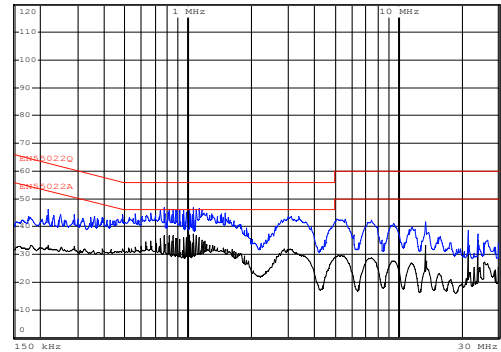

**RE Performance- Horizontal (Peak)**

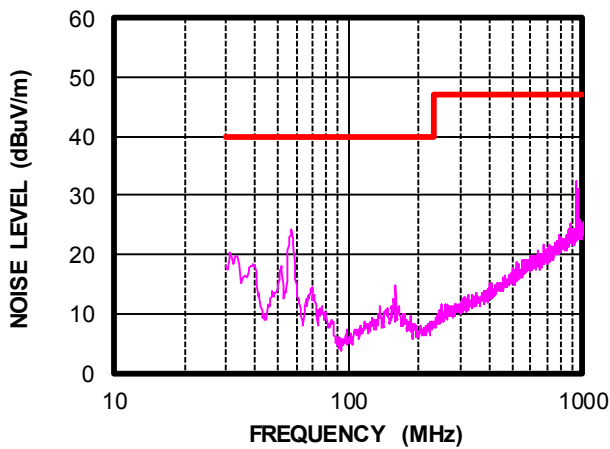

**RE Performance- Vertical (Peak)**

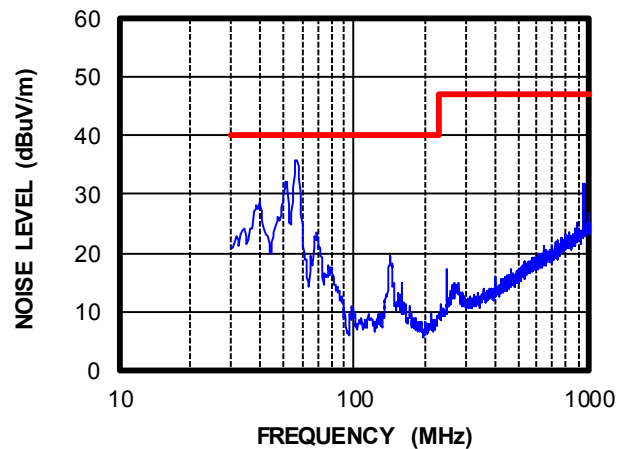

### EVB TEST RESULTS *(continued)*

Performance waveforms are tested on the evaluation board.

$V_{IN}=230V_{AC}$ ,  $V_{OUT}=5V$ ,  $I_{OUT}=50mA$ ,  $T_A=26^{\circ}C$ , unless otherwise noted.

**Load Regulation**

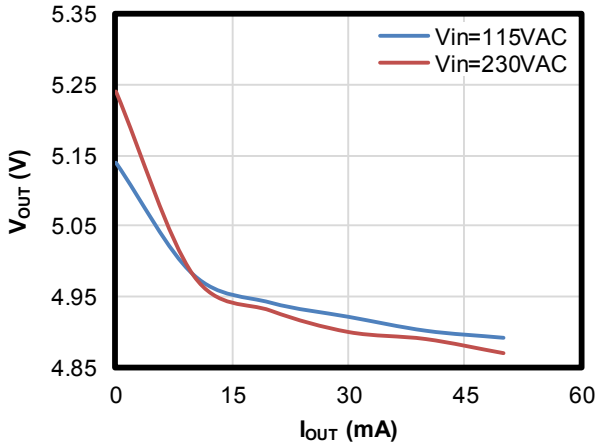

**No Load Consumption**

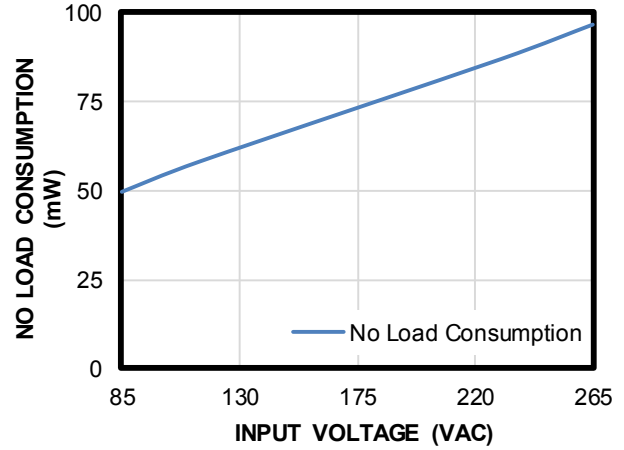

**Efficiency**

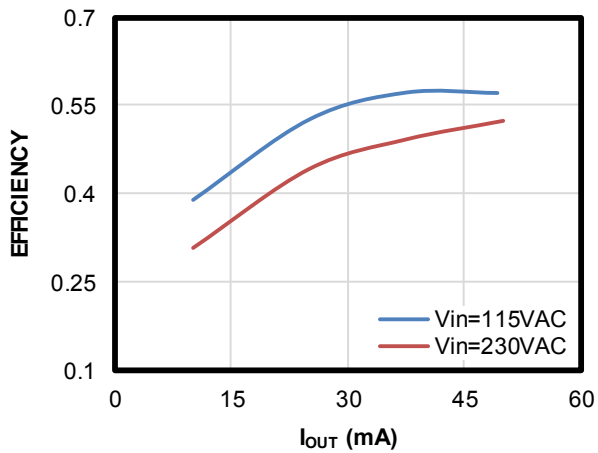



### EVB TEST RESULTS (continued)

Performance waveforms are tested on the evaluation board.

$V_{IN}=230V_{AC}$ ,  $V_{OUT}=5V$ ,  $I_{OUT}=50mA$ ,  $T_A=26^{\circ}C$ , unless otherwise noted.

**Steady State**

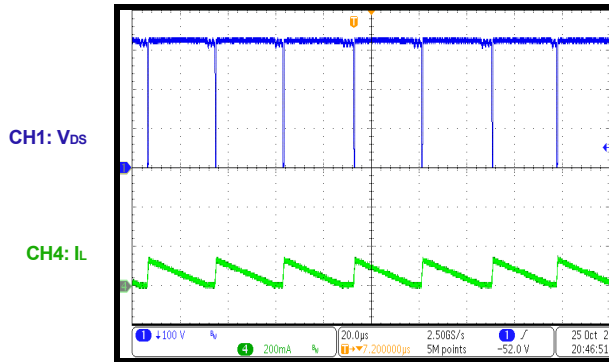

**Output Ripple**

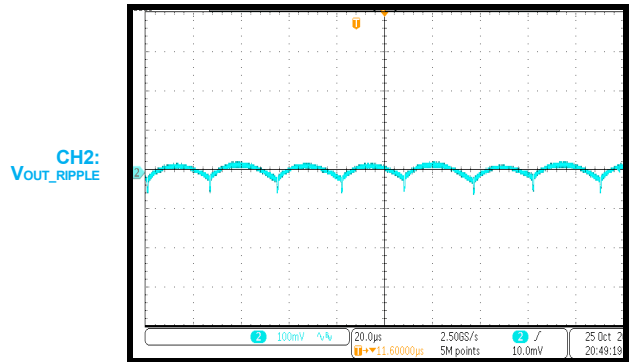

**Start-up**

$V_{IN}=265V_{AC}$ ,  $C_{OUT}=470\mu F$

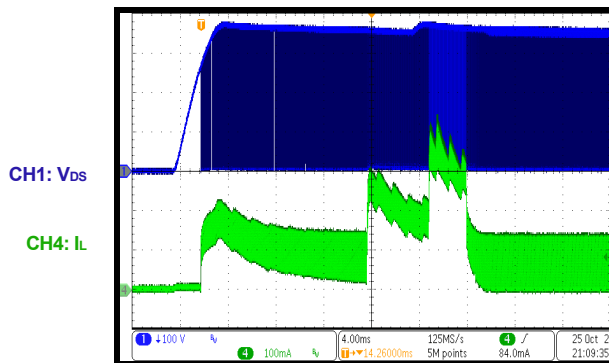

**Shut-down**

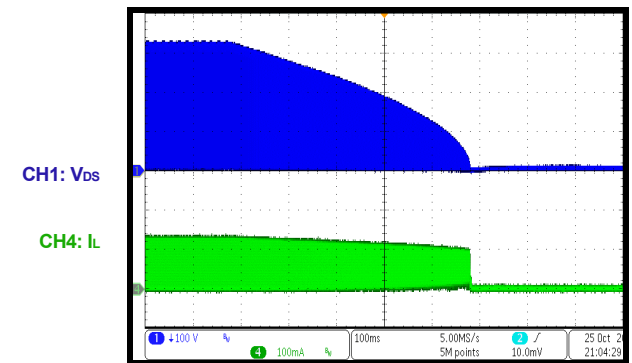

**Load Transient**

1/2 Load to Full Load

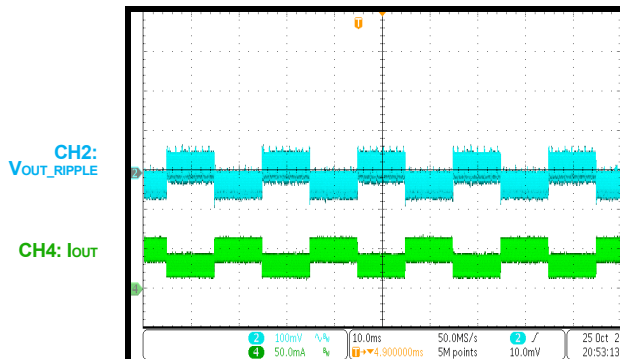

**SCP Entry & Recovery**

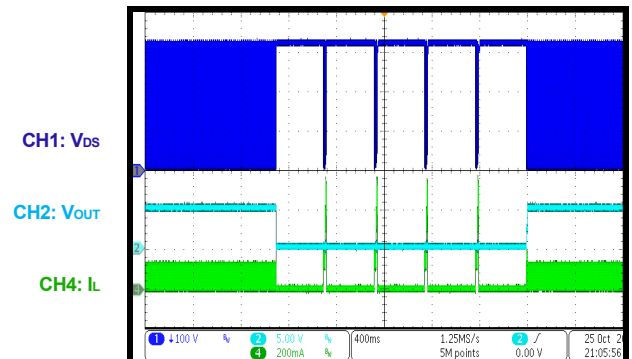

### EVB TEST RESULTS *(continued)*

Performance waveforms are tested on the evaluation board.

$V_{IN}=230V_{AC}$ ,  $V_{OUT}=5V$ ,  $I_{OUT}=50mA$ ,  $T_A=26^{\circ}C$ , unless otherwise noted.

Open Loop Entry & Recovery

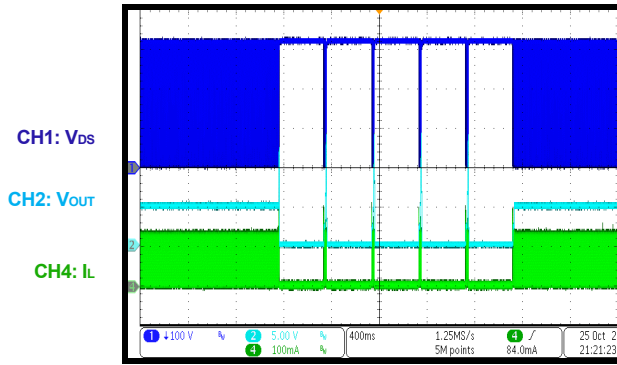

OTP Entry & Recovery

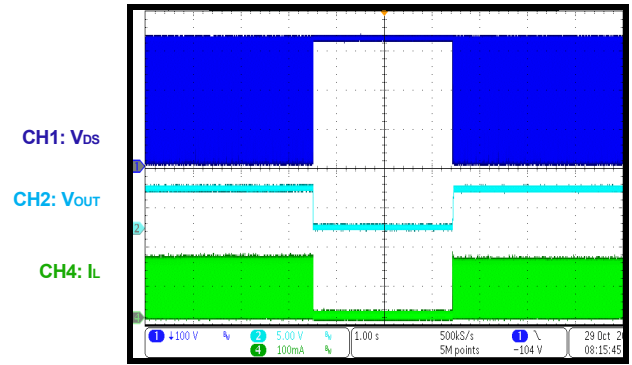

## QUICK START GUIDE

1. Preset power supply to  $85\text{VAC} \leq V_{\text{IN}} \leq 265\text{VAC}$ .
2. Turn power supply off.
3. Connect the Line and Neutral terminals of the power supply to L and N port.
4. Connect load positive and negative terminals to corresponding + and - outputs.
5. Turn power supply on after making connections.

**NOTICE:** The information in this document is subject to change without notice. Please contact MPS for current specifications. Users should warrant and guarantee that third party Intellectual Property rights are not infringed upon when integrating MPS products into any application. MPS will not assume any legal responsibility for any said applications.