

EMP Protector 3401.17.0048-EX

Description

GDT technology up to 1.0 GHz

Benefits

- Self-extinguishing Semper functionality
- Broad-band design
- DC continuity for remote powering
- The protector can also be installed reversely
- Replaceable GDT unit 9071.99.0647, (230 V) included
- Compliant to IEC 61643-21

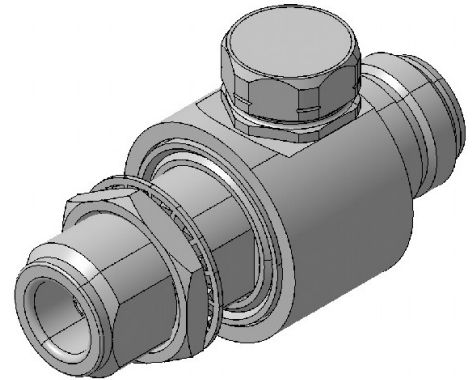

Product Configuration

Main path connectors	Port 1: <u>unprotected</u> , N jack (female) - Port 2: <u>protected</u> , N jack (female)
Mounting and grounding	MH12 (bulkhead mounting), brk (bracket)
Side of bulkhead	protected side

Technical Data

Electrical Data

Impedance	50 Ω
Frequency range	0 - 1000 MHz
Return loss	≥ 24 dB
Insertion loss	≤ 0.1 dB
RF CW power	≤ 150 W
PIM 3rd order	not specified
DC supply voltage	≤ 48 V
DC current	≤ 2.5 A
Surge current handling capability	30 single / 20 multiple kA (test pulse 8/20 μs)
Residual pulse energy	350 μJ typically (test pulse 4 kV 1.2/50 μs / 2 kA 8/20 μs) main path - protected side
Turn-off time	20 s typically at 2.0 A and 25 °C ambient temperature < 40 s typically below 1 A and 25 °C ambient temperature
Recovery time	7 s at 25 °C ambient temperature

Mechanical Data

Number of matings	500
Weight	114 g

Environmental Data

Operating temperature	-40 °C to +85 °C (Lightning protection functionality) -20 °C to +85 °C (SEMPER™ functionality)
Waterproof degree	IP65 (according to IEC 60529, data refer to the coupled state)
2011/65/EU (RoHS - including 2015/863 and 2017/2102)	compliant acc. Annex III

Material Data

Piece Parts	Material	Surface Plating
Housing	Brass	SUCOPLATE (R) Plating
Port 1 center contact	Copper Beryllium Alloy	Gold Plating (without Nickel underplating)
Port 2 center contact	Copper Beryllium Alloy	Gold Plating (without Nickel underplating)

Related Documents

Outline drawing	DOU-00070715.1
Mounting instruction	DOC-0000176104