

RXM2AB2BDPVM

Miniature plug-in relay pre-assembled, 12 A, 2 CO, lockable test button, LED, mixed terminal socket, 24 V DC

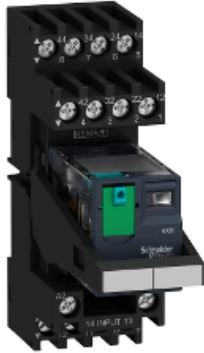

Main

Range of product	Harmony Relay
Series name	Miniature
Product or component type	Plug-in relay
Device short name	RXM
Contacts type and composition	2 C/O
[Uc] control circuit voltage	24 V DC
[Ithe] conventional enclosed thermal current	10 A at -40...55 °C
Status LED	With
Control type	Lockable test button
Utilisation coefficient	20 %

Complementary

[Ui] rated insulation voltage	250 V conforming to IEC
[Uimp] rated impulse withstand voltage	4 kV during 1.2/50 µs
Contacts material	AgNi
[Ie] rated operational current	6 A at 28 V (DC) NC conforming to IEC 6 A at 250 V (AC) NC conforming to IEC 10 A at 28 V (DC) NO conforming to UL 10 A at 250 V (AC) NO conforming to UL
Minimum switching current	10 mA
Maximum switching voltage	250 V
Minimum switching voltage	17 V
Resistive rated load	10 A at 250 V AC 10 A at 28 V DC
Maximum switching capacity	2500 VA AC 280 W DC

Minimum switching capacity	170 mW at 10 mA, 17 V
Operating rate	<= 1200 cycles/hour under load <= 18000 cycles/hour no-load
Mechanical durability	10000000 cycles
Electrical durability	100000 cycles for resistive load
Average coil consumption in W	0.9 W, DC
Drop-out voltage threshold	>= 0.1 U _c DC
Operate time	20 ms
Release time	20 ms
Average coil resistance	650 Ohm at 20 °C +/- 10 %
Rated operational voltage limits	19.2...26.4 V DC
Safety reliability data	B10d = 100000
Protection category	RT I
Test levels	Level A group mounting
Operating position	Any position
Sale per indivisible quantity	30
CAD overall width	26.9 mm
CAD overall height	79 mm
CAD overall depth	78.45 mm
Connections - terminals	Connector, 1 x 0.25...1 x 2.5 mm ² (AWG 22...AWG 14) flexible with cable end Connector, 2 x 0.25...2 x 1 mm ² (AWG 22...AWG 17) flexible with cable end Connector, 1 x 0.5...1 x 2.5 mm ² (AWG 20...AWG 14) solid without cable end Connector, 2 x 0.5...2 x 1.5 mm ² (AWG 20...AWG 16) solid without cable end
Torque value	1 N.m 0.99 N.m
Net weight	0.096 kg
Device presentation	Complete product

Environment

Dielectric strength	1300 V AC between contacts with micro disconnection 2000 V AC between coil and contact 2000 V AC between poles
Product certifications	CE UL CSA EAC RoHS REACH Lloyd's China RoHS
Standards	UL 508 EN/IEC 61810-1 CSA C22.2 No 14 IEC 61984
Ambient air temperature for storage	-40...85 °C
Ambient air temperature for operation	-40...55 °C
Vibration resistance	3 gn, amplitude = +/- 1 mm (f = 10...150 Hz)5 cycles in operation 5 gn, amplitude = +/- 1 mm (f = 10...150 Hz)5 cycles not operating
IP degree of protection	IP20 conforming to EN/IEC 60529
Shock resistance	10 gn for in operation 30 gn for not operating
Pollution degree	2

Packing Units

Package 1 Weight	99.000 g
Package 1 Height	79.000 mm
Package 1 width	26.900 mm
Package 1 Length	78.450 mm

Offer Sustainability

Sustainable offer status	Green Premium product
REACH Regulation	REACH Declaration
REACH free of SVHC	Yes
EU RoHS Directive	Pro-active compliance (Product out of EU RoHS legal scope) EU RoHS Declaration
Toxic heavy metal free	Yes
Mercury free	Yes
RoHS exemption information	Yes
China RoHS Regulation	China RoHS declaration
Environmental Disclosure	Product Environmental Profile
WEEE	The product must be disposed on European Union markets following specific waste collection and never end up in rubbish bins

Contractual warranty

Warranty	18 Months
----------	-----------

Dimensions

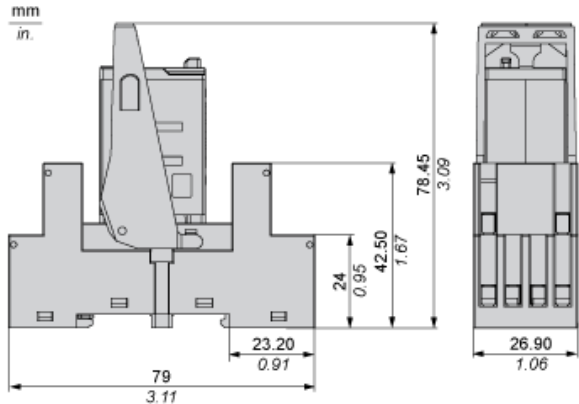

Wiring Diagram

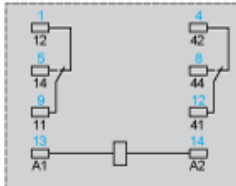
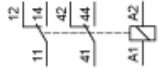

Symbols shown in blue correspond to Nema marking.

Electrical Durability of Contacts

Durability (inductive load) = durability (resistive load) x reduction coefficient.

Resistive AC load

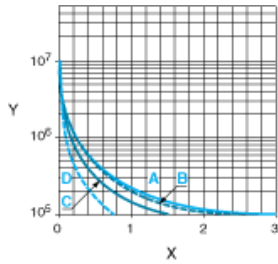

- X Switching capacity (kVA)
- Y Durability (Number of operating cycles)
- A RXM2AB...
- B RXM3AB...
- C RXM4AB...
- D RXM4GB...

Reduction coefficient for inductive AC load (depending on power factor $\cos \phi$)

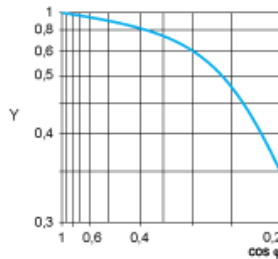

- Y Reduction coefficient (A)

Maximum switching capacity on resistive DC load

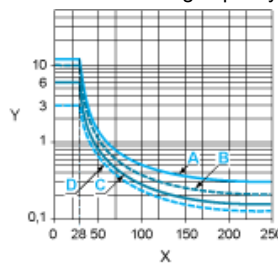

- X Voltage DC
- Y Current DC
- A RXM2AB...
- B RXM3AB...
- C RXM4AB...
- D RXM4GB...

Note : These are typical curves, actual durability depends on load, environment, duty cycle, etc.