

LQH44PH330MPR#

“#” indicates a package specification code.

Size Code 4040 (1515) in mm (in inch), 1.8mm max. Thickness. Low DC resistance design



< List of part numbers with package codes >
LQH44PH330MPRL

Appearance & Shape

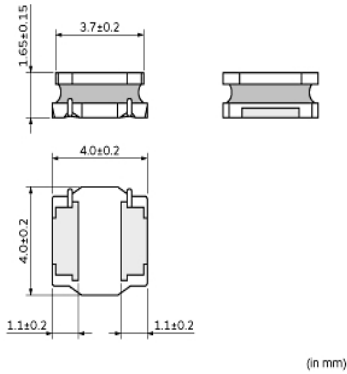
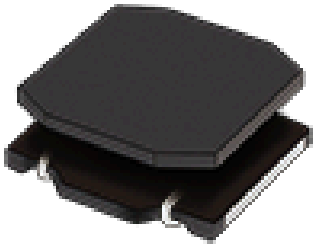

References

Packaging	Specifications	Standard Packing Quantity
L	180Embossed Tape	1000

Mass (typ.)	
1 piece	0.105g

Notices

When rated current is applied to the products, inductance will be within $\pm 30\%$ of initial inductance value range. Keep the temperature (ambient temperature plus self-generation of heat) under 125°C . When rated current is applied to the products, the self-temperature rise shall be limited to 40°C max (ambient temperature 85°C). When rated current is applied to the products, the self-temperature rise shall be limited to 20°C max (ambient temperature 85°C to 105°C).

Attention

- 1.This datasheet is downloaded from the website of Murata Manufacturing Co., Ltd. Therefore, it's specifications are subject to change or our products in it may be discontinued without advance notice. Please check with our sales representatives or product engineers before ordering.
- 2.This datasheet has only typical specifications because there is no space for detailed specifications. Therefore, please review our product specifications or consult the approval sheet for product specifications before ordering.

LQH44PH330MPR#

“#” indicates a package specification code.



Specifications

L size	4.0±0.2mm
W size	4.0±0.2mm
T size	1.65±0.15mm
Size code inch (mm)	1515 (4040)
Inductance	33μH±20%
Inductance Test Frequency	100kHz
Rated current (Isat) (Based on Inductance change)	880mA
Rated current (Itemp) (Based on Temperature rise)	740mA(Ambient temp.85°C) 500mA(Ambient temp.105°C)
Max. of DC resistance	0.552Ω
Operating Temperature Range (Self-temperature rise is included)	-40°C to 125°C
Class of magnetic shield	Magnetic Resin
Self resonance frequency (min.)	12MHz
Operating Temperature Range(Self-temperature rise is not included)	-40°C to 105°C
DC Resistance Intermediate Values	0.46Ω±20%
Series	LQH44PH_PR

Attention

1.This datasheet is downloaded from the website of Murata Manufacturing Co., Ltd. Therefore, it's specifications are subject to change or our products in it may be discontinued without advance notice. Please check with our sales representatives or product engineers before ordering.

2.This datasheet has only typical specifications because there is no space for detailed specifications.

Therefore, please review our product specifications or consult the approval sheet for product specifications before ordering.