

Miniature Waterproof Shielded Connectors

LF Series



Mated dimensions (Example : LF07)

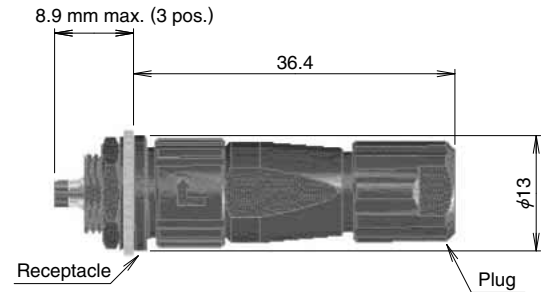

Fig. 1

■ Features

1. Ease of shielded termination and connector assembly

All components are self-aligning and do not require complex assembly tooling. The shield of the cable is connected with the metal housing of the connector using simple shielding clamp, supplied with the connector. (Fig. 2)

2. Water and dust protected

The LF series is a rugged, waterproof connector series that is IP67 and IP68 rated in the mated condition.

IP67 : Left in water at a depth of 1 m for 30 minutes

IP68 : Left in water at a depth of 2 m for 14 days

3. Simplified assembly procedure

No use of screws makes wiring and mounting easier.

4. Bayonet lock

Short turn bayonet lock assures secure vibration resistant mating of the connectors. (Fig. 3)

5. Acquired safety standard

4 pos. is 10A and meets safety standards (TÜV)

Also 3- and 4-pos. have acquired the UL standard.

6. High current rating capacity

No. of contacts	Current rating
3	5A max.
4	10A max.
6, 12 and 20	2A max.
11	10A max. 2A max.

Shielding Connection - Plug

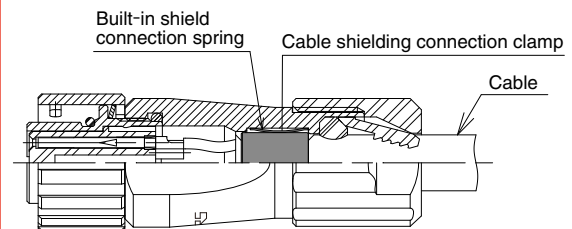
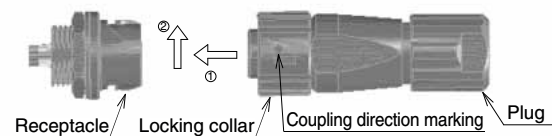

Fig. 2

Short turn bayonet lock

Mating:

Insert the plug, and then turn the locking collar clockwise, as indicated by the coupling direction marking.



Un-mating:

Turn the locking collar counter-clockwise then pull off the plug.

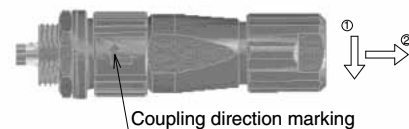

Fig. 3

■ Product Specifications

Ratings	Voltage rating	125V AC, 175V DC (3 pos.) 125V AC, 125V DC (4 pos.) 30V AC, 42V DC (6 pos., 12pos., 20pos.) 125V AC, 125V DC (11 pos. A to D) 30V AC, 42V DC (11 pos. 1 to 7)
	Current rating	5A max. (3 pos.) 10A max. (4 pos.) 2A max. (6 pos., 12pos., 20pos.) 10A(11 pos. A to D), 2A(11 pos. 1 to 7)
	Operating temperature range	-25°C to +85°C
	Storage temperature range	-10°C to +60°C

Item	Specifications	Conditions
1.Contact resistance	15mΩ max. (3, 6, 12, 20 pos.) 5mΩ max. (4 pos.) 5mΩ max. (A to D), 15mΩ max. (1 to 7)(11 pos.)	1A DC
2.Insulation resistance	1000MΩ min.	500V DC (3, 4 pos.) 100V DC (6, 12, 20 pos.) 500V DC (A to D), 100V DC (1 to 7)(11pos.)
3.Withstanding voltage	No flashover or insulation breakdown.	1250V AC/1 minute (3, 4 pos.) 300V AC/1 minute (6, 12, 20 pos.) 1250V AC(A to D),300V AC(1 to 7) / 1 minute(11pos.)
4.Vibration	No electrical discontinuity for 10μs max.	10 → 55 → 10Hz /cycle, single amplitude of 0.75mm 5 minutes / cycle, three directions, 10 cycles for each direction.
5.Shock	No electrical discontinuity for 10μs max	Acceleration of 490m/s ² , duration of 11ms, three directions, three times for each direction.
6.Durability (Mating/un-mating)	30mΩ max. (3, 6, 12, 20 pos.) 10mΩ max. (4 pos.) 10mΩ max.(A to D), 30mΩ max.(1 to 7)(11pos.)	1000 cycles
7.Temperature cycle	Insulation resistance : 100MΩ min.	Temperature : -55°C → Room temperature → +85°C → Room temperature Time : 30 → 2 to 3 → 30 → 2 to 3 (minutes) 5 cycles
8.Humidity	Insulation resistance : 10MΩ min. (at high humidity condition) Insulation resistance : 100MΩ min. (at dry condition)	96 hours at temperature of 40°C and humidity of 90% to 95%.
9.Water / dust protection	When mated with corresponding connector.	Complete dust protection. No water penetration when submerged for 48 hours at the depth of 1.8 meter.

■ Materials / Finish

Components	Material	Finish / Color	Remarks
Body / back shell	Zinc alloy	Nickel plated	—————
Insulator	PPS	Black	UL94V-0
Contacts	Copper alloy	Selective Gold plated	—————
Packing	Chloroprene rubber	Black	—————
Tightening collar	PPS	Brown	UL94V-0

■ Product Number Structure

Refer to the chart below when determining the product specifications from the product number.

Please select from the product numbers listed in this catalog when placing orders.

LF 07 - W B P * - 6 S ()**

① ② ③ ④ ⑤ ⑥ ⑦ ⑧

① Series name	: LF	⑥ No. of contacts	: 3, 4, 6, 11, 12, 20
② Shell size	07 10 13	⑦ Contact type	P : Male contact S : Female contact
③ Waterproof	W : Waterproof type	⑧ Other specifications :	A two-digit character is added to indicate other specifications as needed.
④ Lock Mechanism	B : Bayonet lock		
⑤ Connector type	P : Plug R : Receptacle J : Jack (* : Form change zoning symbols in an identical class)		

■ Plugs

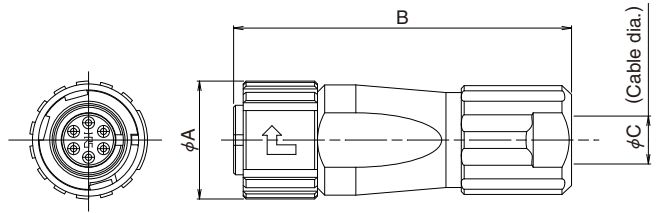

(Representative example.)

Unit : mm

Part No.	HRS No.	No. of contacts	ϕA	B	ϕC	Weight				
LF07WBP-3S(31)	136-0003-7 31	3	12.3	35.8	5	11g				
LF07WBP-3P(31)	136-0004-0 31									
LF07WBP-6S(31)	136-0001-1 31	6								
LF07WBP-6P(31)	136-0002-4 31									
LF10WBP-4S(31)	136-0005-2 31	4					14.8	41.8	7.3	17g
LF10WBP-4P(31)	136-0006-5 31									
LF10WBP-12S(31)	136-0007-8 31	12								
LF10WBP-12P(31)	136-0008-0 31		16g							
LF13WBP-20S	136-0009-3	20	17.9	51.9	8.7	29g				
LF13WBP-20P	136-0010-2									
LF13WBP-11S	136-0011-5						11			
LF13WBP-11P	136-0012-8									

● Lock ease type

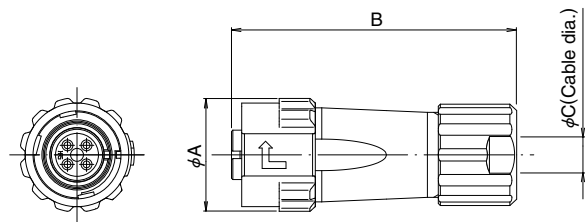

(Representative example.)

Unit : mm

Part No.	HRS No.	No. of contacts	ϕA	B	ϕC	Weight
LF07WBPD-6S(31)	136-0020-6 31	6	14.3	35.8	5	12g
LF10WBPD-4S(31)	136-0014-3 31	4	16.8	41.8	7.3	19g
LF10WBPD-4P(31)	136-0017-1 31					
LF10WBPD-12S(31)	136-0015-6 31	12				
LF10WBPD-12P(31)	136-0018-4 31					

■ Receptacles

● Front panel mount type · Solder Type

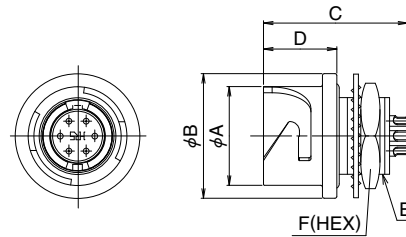

(Representative example.)

Unit : mm

Part No.	HRS No.	No. of contacts	ϕA	ϕB	C	D	E	F	Weight
LF07WBR-3P	136-1003-2	3	10.3	13	16.55	7.65	M9×0.75	11	4g
LF07WBR-3S	136-1004-5				15.05				
LF07WBR-6P	136-1001-7	6	10.3	13	15.25	7.65	M9×0.75	11	4g
LF07WBR-6S	136-1002-0				15.25				
LF10WBR-4P	136-1005-8	4	12.8	15.3	19.05	7.75	M11×0.75	13	6g
LF10WBR-4S	136-1006-0				17.25				5g
LF10WBR-12P	136-1007-3	12	12.8	15.3	17.25	7.75	M11×0.75	13	6g
LF10WBR-12S	136-1008-6				19.05				9g
LF13WBR-20P	136-1009-9	20	15.9	18.3	17.25	7.75	M14×0.75	17	10g
LF13WBR-20S	136-1010-8				19.05				9g
LF13WBR-11P	136-1011-0	11	15.9	18.3	19.05	7.75	M14×0.75	17	10g
LF13WBR-11S	136-1012-3				19.05				10g

● Front panel mount type · Through hole Type

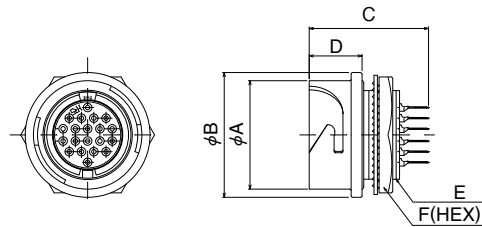

(Representative example.)

Unit : mm

Part No.	HRS No.	No. of contacts	ϕA	ϕB	C	D	E	F	Weight
LF13WBR-20SD	136-1017-7	20	15.9	18.3	17.5	7.75	M14×0.75	17	9g

■ Receptacles

● Rear panel mount type · Solder Type

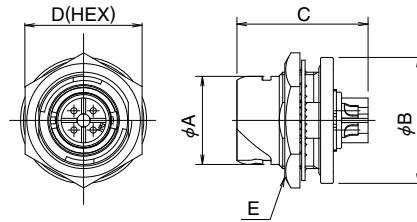

(Representative example.)

Unit : mm

Part No.	HRS No.	No. of contacts	φA	φB	C	D	E	Weight
LF10WBRB-4P	136-1118-4	4	12.8	18.3	19.05	17	M14×0.75	10g
LF10WBRB-12P	136-1013-6	12			17.25			
LF10WBRB-12S	136-1014-9	12	15.9	21.5	19.25	20	M17×0.75	16g
LF13WBRB-20S	136-1018-0	20						
LF13WBRB-11S	136-1019-2	11						

● Rear panel mount type · Through hole Type

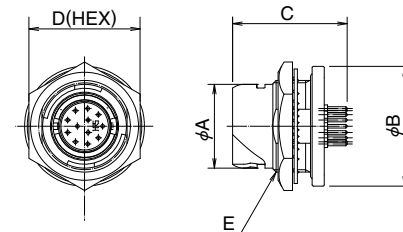

(Representative example.)

Unit : mm

Part No.	HRS No.	No. of contacts	φA	φB	C	D	E	Weight
LF10WBRB-12PD	136-1015-1	12	12.8	18.3	17.5	17	M14×0.75	9g
LF10WBRB-12SD	136-1016-4							

■ Jacks

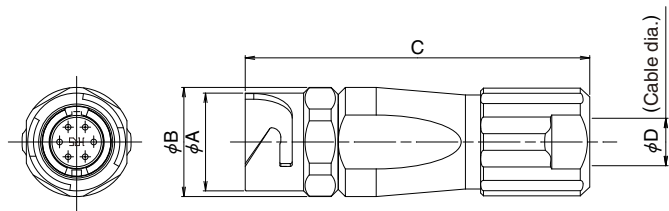

(Representative example.)

Unit : mm

Part No.	HRS No.	No. of contacts	φA	φB	C	φD	Weight
LF07WBJ-3P	136-2003-8	3	10.3	11.5	36.3	5	11g
LF07WBJ-3S	136-2004-0						
LF07WBJ-6P	136-2001-2	6	12.8	13.8	42.4	7.3	16g
LF07WBJ-6S	136-2002-5						
LF10WBJ-4P	136-2005-3	4	12.8	13.8	42.4	7.3	16g
LF10WBJ-4S	136-2006-6						
LF10WBJ-12P	136-2007-9	12	15.9	16.9	52.4	8.7	29g
LF10WBJ-12S	136-2008-1						30g
LF13WBJ-20P	136-2009-4	20	15.9	16.9	52.4	8.7	29g
LF13WBJ-20S	136-2010-3						30g
LF13WBJ-11P	136-2011-6	11	15.9	16.9	52.4	8.7	29g
LF13WBJ-11S	136-2012-9						30g

■ CAP

● For Receptacles

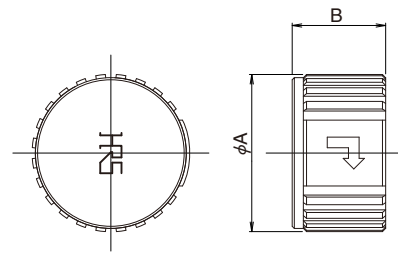

(Representative example.)

Unit : mm

Part No.	HRS No.	Applicable connector	φA	B	Weight	
LF07WBR-C	136-3008-7	LF07WBR-6P	12.3	8.8	4g	
		LF07WBR-6S				
		LF07WBR-3P				
		LF07WBR-3S				
LF10WBR-C	136-3001-8	LF10WBR-4P	14.8		8.8	5g
		LF10WBR-4S				
		LF10WBR-12P				
		LF10WBR-12S				
		LF10WBRB-4P				
		LF10WBRB-12P				
		LF10WBRB-12S				
		LF10WBRB-12PD				
LF13WBR-C	136-3003-3	LF13WBR-20P	17.9	8.8	7g	
		LF13WBR-20S				
		LF13WBR-11P				
		LF13WBR-11S				
		LF13WBR-20SD				
		LF13WBRB-20S				
		LF13WBRB-11S				

◆Applicable tools

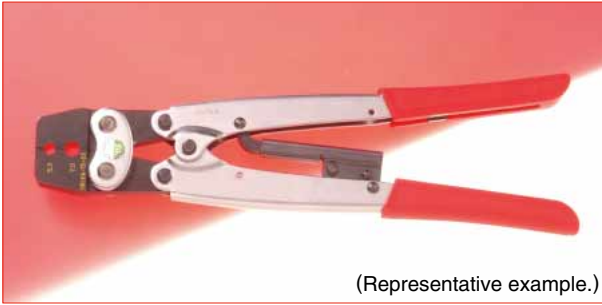

Unit : mm

Description	Part No.	HRS No.	LF series Applicable cable dia.
Manual cable clamp crimp	HR10A-TC-02	150-0041-2	5 (Note)
	LF-TC-01	150-0234-6	7.3 · 8.7

Note : Applicable cable dia. is only 5mm for LF series.

◆Solder termination fixture

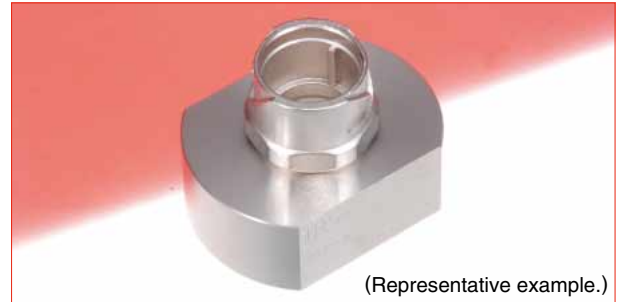

Part No.	HRS No.	Applicable connectors
LF07BP-T01	150-0232-0	LF07WBP-**
LF07BJ-T01	150-0233-3	LF07WBJ-**
LF10BP-T01	150-0235-9	LF10WBP-**
LF10BJ-T01	150-0236-1	LF10WBJ-**
LF13BP-T01	150-0237-4	LF13WBP-**
LF13BJ-T01	150-0238-7	LF13WBJ-**

Note : It is applicable regard less of given alphabets or Numbers shown at *.

◆Panel Cutout

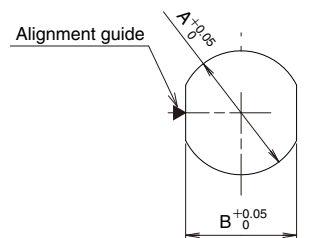

Unit : mm

Shell size	A	B	Weight
LF07WBR-**	$\phi 9.05$	8.1	0.7 to 2
LF10WBR-**	$\phi 11.05$	10.2	
LF13WBR-**	$\phi 14.05$	13.1	
LF10WBRB-**	$\phi 14.05$	13.1	0.7 to 4.8
LF13WBRB-**	$\phi 17.05$	16.1	

◆Contact position arrangement and specifications

Shell size	LF07		LF10		LF13		
Contact arrangement							
No. of contacts	3	6	4	12	11	20	
Withstanding voltage	1250V AC	300V AC	1250V AC	300V AC	4	7	AC300V
					AC1250V	AC300V	
Current rating	5A	2A	10A	2A	4	7	2A
					10A	2A	
Insulation resistance	1000M Ω						
Contact resistance	15m Ω		5m Ω	15m Ω	4	7	15m Ω
					5m Ω	15m Ω	
Solder pot inner diameter	1.15mm	0.8mm	1.7mm	0.8mm	4	7	0.8mm
					$\phi 1.7$	$\phi 0.8$	

Note 1 : The contact configuration as viewed from the female contact connector mating side.

Note 2 : The ▼ symbol indicates polarizing key position.

Note 3 : Withstanding voltages are test voltage values.

◆ Termination and Assembly Instructions

The connectors are delivered with pre-assembled condition and the disassembly as shown No.1.

No.	Illustration	Operation								
1		<p>Plug disassembly</p> <p>① Insert the plug into securely held solder termination fixture as shown.</p> <table border="1"> <thead> <tr> <th>Fixture Part No.</th> <th>Applicable connector</th> </tr> </thead> <tbody> <tr> <td>LF07BP-T01</td> <td>LF07WBP-6S,6P,3S,3P</td> </tr> <tr> <td>LF10BP-T01</td> <td>LF10WBP-4S,4P,12S,12P</td> </tr> <tr> <td>LF13BP-T01</td> <td>LF13WBP-20S,20P,11S,11P</td> </tr> </tbody> </table>	Fixture Part No.	Applicable connector	LF07BP-T01	LF07WBP-6S,6P,3S,3P	LF10BP-T01	LF10WBP-4S,4P,12S,12P	LF13BP-T01	LF13WBP-20S,20P,11S,11P
	Fixture Part No.	Applicable connector								
	LF07BP-T01	LF07WBP-6S,6P,3S,3P								
	LF10BP-T01	LF10WBP-4S,4P,12S,12P								
LF13BP-T01	LF13WBP-20S,20P,11S,11P									
	<p>② Loosen the backshell turning it counter clockwise and remove it from the body/ insulator assembly.</p> <p>Note When removing, assembling and wiring, be sure to use a solder termination fixture. Directly fixing the locking collar in place with a vice etc.. could lead to damage, deformation or lacuna of retaining ring.</p>									
	<p>Jack Disassembly</p> <p>① Insert the jack into the securely held solder termination fixture as shown.</p> <table border="1"> <thead> <tr> <th>Fixture Part No.</th> <th>Applicable connector</th> </tr> </thead> <tbody> <tr> <td>LF07BJ-T01</td> <td>LF07WBJ-6S,6P,3S,3P</td> </tr> <tr> <td>LF10BJ-T01</td> <td>LF10WBJ-4S,4P,12S,12P</td> </tr> <tr> <td>LF13BJ-T01</td> <td>LF13WBJ-20S,20P,11S,11P</td> </tr> </tbody> </table>	Fixture Part No.	Applicable connector	LF07BJ-T01	LF07WBJ-6S,6P,3S,3P	LF10BJ-T01	LF10WBJ-4S,4P,12S,12P	LF13BJ-T01	LF13WBJ-20S,20P,11S,11P	
Fixture Part No.	Applicable connector									
LF07BJ-T01	LF07WBJ-6S,6P,3S,3P									
LF10BJ-T01	LF10WBJ-4S,4P,12S,12P									
LF13BJ-T01	LF13WBJ-20S,20P,11S,11P									
	<p>② Loosen the backshell turning it counterclockwise.</p> <p>Note When removing, assembling and wiring, be sure to use a solder termination fixture. Directly fixing the body in place with a vice etc.. could lead to damage or deformation.</p>									
2		<p>Connector Assembly</p> <p>① Apply a coating of Loctite 7649 (Manufactured by Henkel Japan, Ltd.) primer to the threaded sections of the backshell and the tightening collar. Completely dry the coated surfaces.</p> <p>Notes</p> <ol style="list-style-type: none"> (1) Drying time at room temperature is approximately 30 to 70 seconds. (2) Ensure sufficient ventilation of the area at time of drying. (3) Take necessary steps to protect the coated surfaces from contamination. 								
		<p>② Thread the tightening collar, strain relief collar, seal bushing and the backshell over the cable as illustrated.</p> <p>Note Threading the components may not be possible after the cable-end finishing process.</p>								

Jan. 1. 2021 Copyright 2021 HIROSE ELECTRIC CO., LTD. All Rights Reserved.

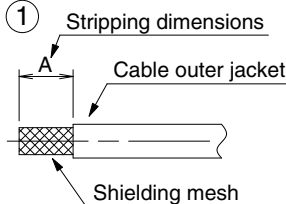
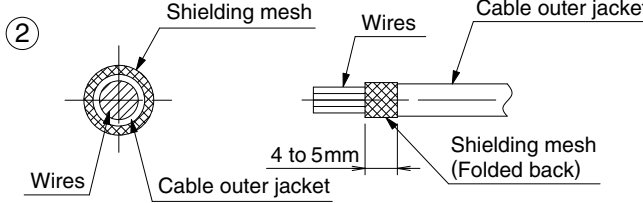
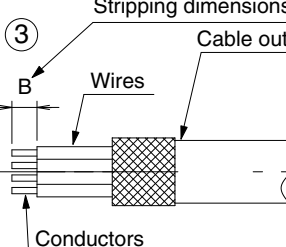
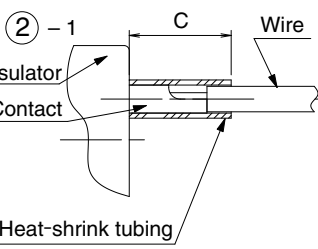
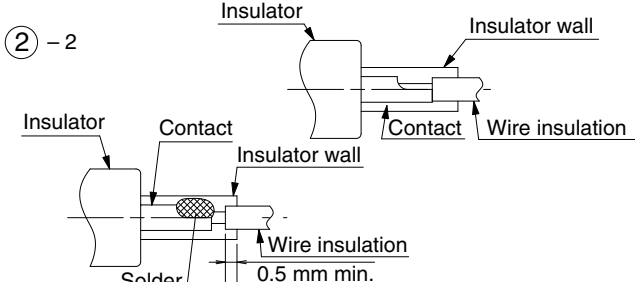
No.	Illustration	Operation																					
<p>3</p>	<p>① Stripping dimensions</p>  <p>Table 1. Stripping Dimensions</p> <table border="1" data-bbox="582 414 933 593"> <thead> <tr> <th>No. of Conductors</th> <th>A mm</th> </tr> </thead> <tbody> <tr> <td>3</td> <td rowspan="2">8 to 9</td> </tr> <tr> <td>6</td> </tr> <tr> <td>4</td> <td>13 to 14</td> </tr> <tr> <td>12</td> <td>14 to 15</td> </tr> <tr> <td>11</td> <td>22 to 23 (No.A to D) 23 to 24 (No.1 to 7)</td> </tr> <tr> <td>20</td> <td>23 to 24</td> </tr> </tbody> </table>	No. of Conductors	A mm	3	8 to 9	6	4	13 to 14	12	14 to 15	11	22 to 23 (No.A to D) 23 to 24 (No.1 to 7)	20	23 to 24	<p>Cable preparation</p> <p>① Strip the cable's outer jacket to the dimensions illustrated in the table 1.</p> <p>Notes</p> <p>(1) Exercise caution not to damage the shielding mesh.</p> <p>(2) Any damage to the cable's outer jacket may affect the waterproof performance of the assembled connector.</p>								
	No. of Conductors	A mm																					
	3	8 to 9																					
6																							
4	13 to 14																						
12	14 to 15																						
11	22 to 23 (No.A to D) 23 to 24 (No.1 to 7)																						
20	23 to 24																						
<p>②</p> 	<p>② Fold back the shielding mesh over the cable's outer jacket assuring that it is uniform on its diameter.</p>																						
<p>③ Stripping dimensions</p>  <p>Table 2. Stripping Dimensions</p> <table border="1" data-bbox="614 918 933 1086"> <thead> <tr> <th>No. of Conductors</th> <th>B mm</th> </tr> </thead> <tbody> <tr> <td>3</td> <td>2.5±0.5</td> </tr> <tr> <td>6</td> <td>2±0.5</td> </tr> <tr> <td>4</td> <td>3±0.5</td> </tr> <tr> <td>12</td> <td>2±0.5</td> </tr> <tr> <td>11</td> <td>3±0.5 (No.A to D) 2±0.5 (No.1 to 7)</td> </tr> <tr> <td>20</td> <td>2±0.5</td> </tr> </tbody> </table>	No. of Conductors	B mm	3	2.5±0.5	6	2±0.5	4	3±0.5	12	2±0.5	11	3±0.5 (No.A to D) 2±0.5 (No.1 to 7)	20	2±0.5	<p>③ Strip the wires to the dimensions illustrated in the Table 2.</p> <p>Note</p> <p>When stripping the wires exercise caution not to damage it's insulation, folded over shielding mesh or cable's outer jacket. It may cause defects in insulation, conduction, and waterproof performance.</p>								
No. of Conductors	B mm																						
3	2.5±0.5																						
6	2±0.5																						
4	3±0.5																						
12	2±0.5																						
11	3±0.5 (No.A to D) 2±0.5 (No.1 to 7)																						
20	2±0.5																						
<p>4</p>	<p>② - 1</p>  <p>Table 3 Heat shrink tubing Dimensions</p> <table border="1" data-bbox="622 1489 933 1758"> <thead> <tr> <th>No. of Conductors</th> <th>No. of contacts</th> <th>C mm</th> </tr> </thead> <tbody> <tr> <td rowspan="2">6</td> <td>1 to 6</td> <td>4</td> </tr> <tr> <td>1 to 9</td> <td>4</td> </tr> <tr> <td rowspan="2">12</td> <td>10 to 12</td> <td>6</td> </tr> <tr> <td>1 to 4</td> <td>6</td> </tr> <tr> <td rowspan="2">11</td> <td>5 to 7</td> <td>4</td> </tr> <tr> <td>1 to 5, 16 to 20</td> <td>4</td> </tr> <tr> <td rowspan="2">20</td> <td>6 to 15</td> <td>6</td> </tr> </tbody> </table>	No. of Conductors	No. of contacts	C mm	6	1 to 6	4	1 to 9	4	12	10 to 12	6	1 to 4	6	11	5 to 7	4	1 to 5, 16 to 20	4	20	6 to 15	6	<p>Soldering</p> <p>① Soldering conditions</p> <p>Soldering iron tip temperature: 350±10℃</p> <p>Soldering time: within 5 sec.</p> <p>Notes</p> <p>(1) Assure that the solder compound is sufficiently melted on the soldering iron tip.</p> <p>(2) When applying, make sure that the solder will flow correctly at all the contact surfaces between the conductor and the contact.</p>
	No. of Conductors	No. of contacts	C mm																				
	6	1 to 6	4																				
1 to 9		4																					
12	10 to 12	6																					
	1 to 4	6																					
11	5 to 7	4																					
	1 to 5, 16 to 20	4																					
20	6 to 15	6																					
	<p>② - 2</p> 	<p>② - 1 6, 12, 11(No.1 to 7), 20 Conductors</p> <p>(1) Place a heat-shrink tubing (inside diameter of 1.1 mm min.) over every other wire. Perform the soldering of the contact and the (2) conductor, with the wire's insulation touching the contact as shown. After soldering, slide the heat shrink tubing (3) over the soldered joint and shrink it. The tubing should touch the insulator as shown.</p>																					
<p>② - 2 3, 4, 11(No.A to D) Conductors</p> <p>(1) Perform the soldering of the contact and the conductor, with the wire's insulation touching the contact as illustrated.</p> <p>(2) When soldering, to maintain the insulation between adjacent contacts. Make sure that the wire's insulation remains below the edge of the insulator's wall 0.5 mm min., as illustrated.</p>																							

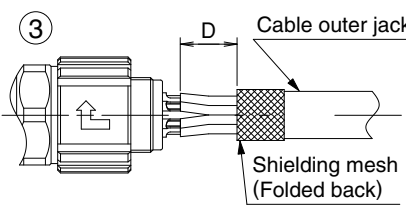
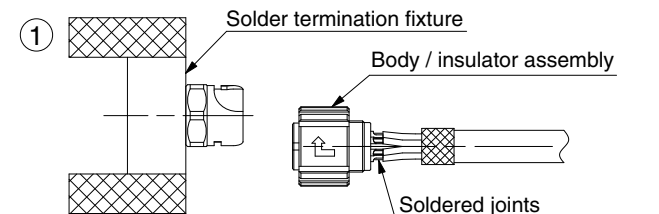
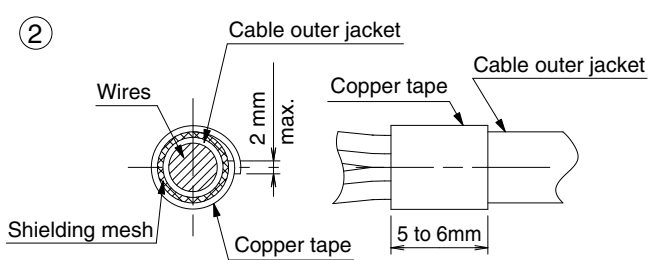
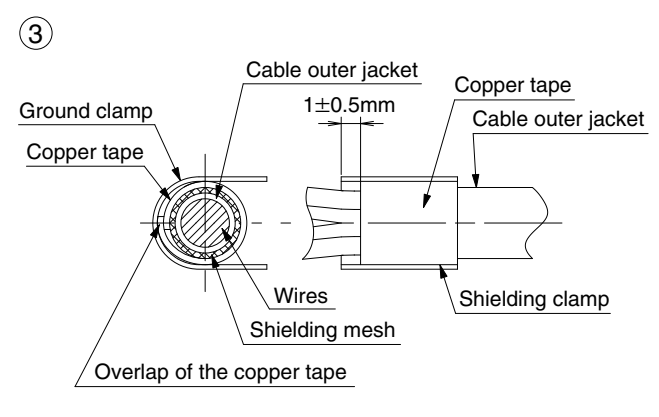
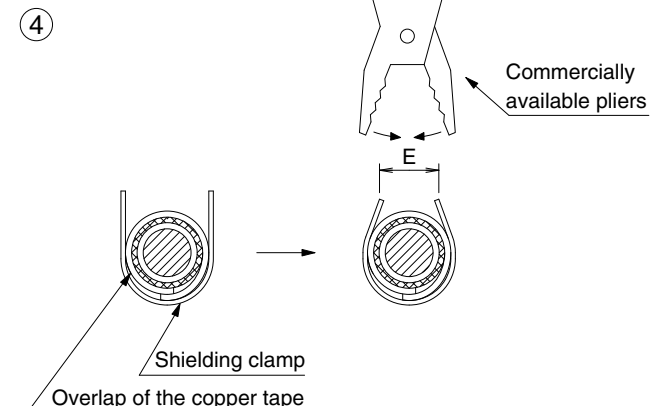
No.	Illustration	Operation												
4	 <p>③</p> <p>Cable outer jacket</p> <p>Shielding mesh (Folded back)</p> <p>D</p> <p>Table 4. Wire Dimensions</p> <table border="1" data-bbox="678 369 933 537"> <thead> <tr> <th>No. of Conductors</th> <th>D mm</th> </tr> </thead> <tbody> <tr> <td>3</td> <td rowspan="2">6 to 7</td> </tr> <tr> <td>6</td> </tr> <tr> <td>4</td> <td>10 to 11</td> </tr> <tr> <td>12</td> <td>13 to 14</td> </tr> <tr> <td>11</td> <td rowspan="2">18 to 19</td> </tr> <tr> <td>20</td> </tr> </tbody> </table>	No. of Conductors	D mm	3	6 to 7	6	4	10 to 11	12	13 to 14	11	18 to 19	20	<p>③ After the soldering, keep a distance of D between the contact end and the cable's outer jacket as illustrated.</p> <p>Note</p> <p>The distance of D is required in order to assure correct assembly of the backshell.</p>
No. of Conductors	D mm													
3	6 to 7													
6														
4	10 to 11													
12	13 to 14													
11	18 to 19													
20														
5	 <p>①</p> <p>Solder termination fixture</p> <p>Body / insulator assembly</p> <p>Soldered joints</p>	<p>Crimping of the Shielding Clamp</p> <p>① After completion of the soldering operations carefully remove (holding on the locking collar) the body/insulator assembly from the solder termination fixture.</p> <p>Note</p> <p>Exercise caution not to damage or deform the solder joints.</p>												
	 <p>②</p> <p>Cable outer jacket</p> <p>Wires</p> <p>Shielding mesh</p> <p>Copper tape</p> <p>2 mm max.</p> <p>Cable outer jacket</p> <p>Copper tape</p> <p>5 to 6mm</p>	<p>② Wrap the folded over shielding mesh with 5 to 6mm wide copper tape to assure that it will not become loose.</p> <p>Apply the copper tape so that the shielding mesh does not protrude from under it.</p> <p>Note</p> <p>After wrapping the copper tape, the tape should overlap itself by 2mm max.</p>												
	 <p>③</p> <p>Cable outer jacket</p> <p>Ground clamp</p> <p>Copper tape</p> <p>Wires</p> <p>Shielding mesh</p> <p>Overlap of the copper tape</p> <p>1 ± 0.5mm</p> <p>Cable outer jacket</p> <p>Copper tape</p> <p>Shielding clamp</p>	<p>③ Insert the "U" shaped shielding clamp over the copper tape as shown on the illustration. It is critical that the overlap of the copper tape is located inside the shielding clamp as shown on the illustration.</p> <p>Note</p> <p>When the end of the copper tape wrapping is positioned at the open side of the ground fitting, the end portion of the copper tape wrapping will no longer be covered by the ground fitting when the ground fitting is crimped.</p>												
	 <p>④</p> <p>Shielding clamp</p> <p>Overlap of the copper tape</p> <p>Commercially available pliers</p> <p>E</p>	<p>④ Using commercially available pliers bend the open ends of the shielding clamp as illustrated, assuring that it stays in place. The dimension of E, between opposing edges of the shielding clamp is necessary to assure correct final crimp.</p> <p>Table 5</p> <table border="1" data-bbox="989 1825 1300 1937"> <thead> <tr> <th>Shell size</th> <th>E</th> </tr> </thead> <tbody> <tr> <td>LF07</td> <td>5mm max.</td> </tr> <tr> <td>LF10</td> <td rowspan="2">7mm max.</td> </tr> <tr> <td>LF13</td> </tr> </tbody> </table>	Shell size	E	LF07	5mm max.	LF10	7mm max.	LF13					
Shell size	E													
LF07	5mm max.													
LF10	7mm max.													
LF13														

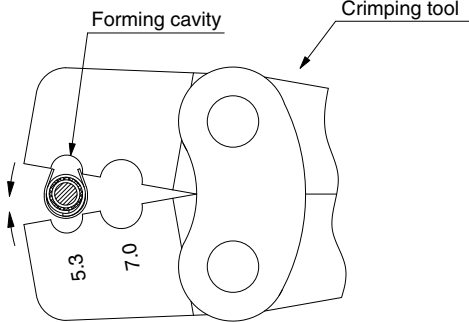
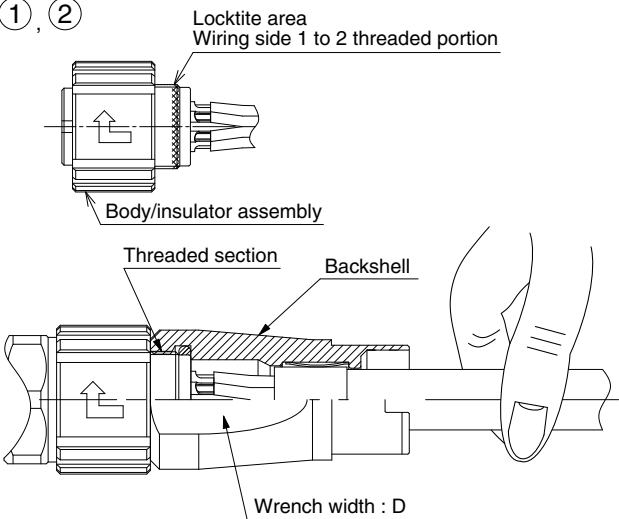
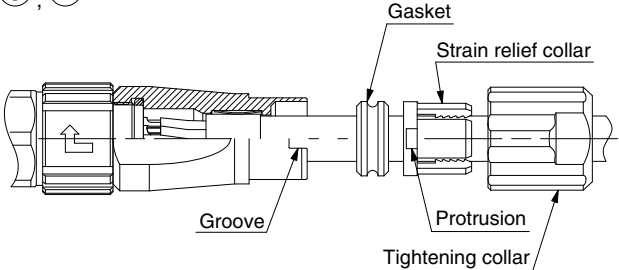
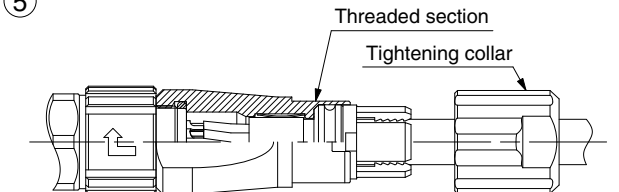
No.	Illustration	Operation																												
5	<p>⑤</p>  <p>Forming cavity</p> <p>Crimping tool</p> <p>5.3</p> <p>7.0</p>	<p>⑤ Both sides of the shielding clamp must be placed in the forming cavity of the tool (as shown on the illustration) and crimped over the cable by closing the tool completely.</p> <table border="1" data-bbox="954 432 1412 622"> <thead> <tr> <th>Crimping tool</th> <th>Forming cavity</th> <th>Applicable cable diameter</th> <th>Shielding clamp diameter after crimping</th> </tr> </thead> <tbody> <tr> <td rowspan="2">HR10A-TC-02</td> <td>5.3</td> <td>5mm</td> <td>5.3mm to 5.5mm</td> </tr> <tr> <td>7.0</td> <td>—</td> <td>—</td> </tr> <tr> <td rowspan="2">LF-TC-01</td> <td>7.9</td> <td>7.3mm</td> <td>7.9mm to 8.1mm</td> </tr> <tr> <td>9.1</td> <td>8.7mm</td> <td>9.1mm to 9.3mm</td> </tr> </tbody> </table>	Crimping tool	Forming cavity	Applicable cable diameter	Shielding clamp diameter after crimping	HR10A-TC-02	5.3	5mm	5.3mm to 5.5mm	7.0	—	—	LF-TC-01	7.9	7.3mm	7.9mm to 8.1mm	9.1	8.7mm	9.1mm to 9.3mm										
Crimping tool	Forming cavity	Applicable cable diameter	Shielding clamp diameter after crimping																											
HR10A-TC-02	5.3	5mm	5.3mm to 5.5mm																											
	7.0	—	—																											
LF-TC-01	7.9	7.3mm	7.9mm to 8.1mm																											
	9.1	8.7mm	9.1mm to 9.3mm																											
6	<p>①, ②</p>  <p>Locktite area Wiring side 1 to 2 threaded portion</p> <p>Body/insulator assembly</p> <p>Threaded section</p> <p>Backshell</p> <p>Wrench width : D</p> <p>Table 6 (Recommend tightening torque)</p> <table border="1" data-bbox="528 1249 911 1368"> <thead> <tr> <th>Shell size</th> <th>Tightening torque</th> <th>Wrench width</th> </tr> </thead> <tbody> <tr> <td>LF07</td> <td>1N·m to 1.5N·m</td> <td>10mm</td> </tr> <tr> <td>LF10</td> <td>1N·m to 1.5N·m</td> <td>13mm</td> </tr> <tr> <td>LF13</td> <td>1.5N·m to 2N·m</td> <td>16mm</td> </tr> </tbody> </table>	Shell size	Tightening torque	Wrench width	LF07	1N·m to 1.5N·m	10mm	LF10	1N·m to 1.5N·m	13mm	LF13	1.5N·m to 2N·m	16mm	<h3>Connector Assembly</h3> <p>① Place the body/insulator assembly in the applicable solder termination fixture.</p> <p>For plug assembly</p> <table border="1" data-bbox="986 790 1337 869"> <thead> <tr> <th>Fixture Part No.</th> <th>Applicable connector</th> </tr> </thead> <tbody> <tr> <td>LF07BP-T01</td> <td>LF07WBP-6S,6P,3S,3P</td> </tr> <tr> <td>LF10BP-T01</td> <td>LF10WBP-4S,4P,12S,12P</td> </tr> <tr> <td>LF13BP-T01</td> <td>LF13WBP-20S,20P,11S,11P</td> </tr> </tbody> </table> <p>For jack assembly</p> <table border="1" data-bbox="986 891 1337 969"> <thead> <tr> <th>Fixture Part No.</th> <th>Applicable connector</th> </tr> </thead> <tbody> <tr> <td>LF07BJ-T01</td> <td>LF07WBJ-6S,6P,3S,3P</td> </tr> <tr> <td>LF10BJ-T01</td> <td>LF10WBJ-4S,4P,12S,12P</td> </tr> <tr> <td>LF13BJ-T01</td> <td>LF13WBJ-20S,20P,11S,11P</td> </tr> </tbody> </table> <p>② Coat the thread section of the body/insulator assembly with Loctite 263 compound (manufactured by Henkel Japan, Ltd.) or equivalent, tightening it with a torque specified in the table 6.</p> <p>Notes</p> <p>(1) The applied loctite should not protrude out further than the wiring side 1 to 2 threaded section. If it does, it may affect waterproof performance and locking. Please remove any protruding loctite with a cloth or cotton swab. etc.</p> <p>(2) It is critical that the cable itself will not turn or twist during this operation. It may cause breakage at the soldered area.</p>	Fixture Part No.	Applicable connector	LF07BP-T01	LF07WBP-6S,6P,3S,3P	LF10BP-T01	LF10WBP-4S,4P,12S,12P	LF13BP-T01	LF13WBP-20S,20P,11S,11P	Fixture Part No.	Applicable connector	LF07BJ-T01	LF07WBJ-6S,6P,3S,3P	LF10BJ-T01	LF10WBJ-4S,4P,12S,12P	LF13BJ-T01	LF13WBJ-20S,20P,11S,11P
Shell size	Tightening torque	Wrench width																												
LF07	1N·m to 1.5N·m	10mm																												
LF10	1N·m to 1.5N·m	13mm																												
LF13	1.5N·m to 2N·m	16mm																												
Fixture Part No.	Applicable connector																													
LF07BP-T01	LF07WBP-6S,6P,3S,3P																													
LF10BP-T01	LF10WBP-4S,4P,12S,12P																													
LF13BP-T01	LF13WBP-20S,20P,11S,11P																													
Fixture Part No.	Applicable connector																													
LF07BJ-T01	LF07WBJ-6S,6P,3S,3P																													
LF10BJ-T01	LF10WBJ-4S,4P,12S,12P																													
LF13BJ-T01	LF13WBJ-20S,20P,11S,11P																													
	<p>③, ④</p>  <p>Gasket</p> <p>Strain relief collar</p> <p>Groove</p> <p>Protrusion</p> <p>Tightening collar</p>	<p>③ Slide forward the gasket and insert it in the backshell until fully seated.</p> <p>④ Slide forward the strain relief collar and insert it in the backshell, making sure that the opposing protrusions fit inside the corresponding grooves, as shown on the illustration.</p> <p>Note</p> <p>It is critical that the protrusions are inside the corresponding grooves. It may cause breakage, when a tightening collar is assembled.</p>																												
	<p>⑤</p>  <p>Threaded section</p> <p>Tightening collar</p>	<p>⑤ Verify that the Loctite 7649 primer (or equivalent) on the threaded sections of the backshell and tightening collar are dry. Apply the Loctite 263 compound to the tightening collar's threaded section and attach it to the backshell.</p>																												

No.	Illustration	Operation												
6		<p>⑥ Remove the connector from the solder termination fixture, holding it by the locking collar. Do not pull on the cable. It may cause breakage.</p> <table border="1" style="margin-left: auto; margin-right: auto;"> <caption>Recommended tightening torque</caption> <thead> <tr> <th>Shell size</th> <th>Tightening torque</th> <th>Wrench width</th> </tr> </thead> <tbody> <tr> <td>LF07</td> <td>0.8N·m to 1N·m</td> <td>10mm</td> </tr> <tr> <td>LF10</td> <td>0.7N·m to 1N·m</td> <td>14mm</td> </tr> <tr> <td>LF13</td> <td>1 N·m to 1.5 N·m</td> <td>16mm</td> </tr> </tbody> </table>	Shell size	Tightening torque	Wrench width	LF07	0.8N·m to 1N·m	10mm	LF10	0.7N·m to 1N·m	14mm	LF13	1 N·m to 1.5 N·m	16mm
Shell size	Tightening torque	Wrench width												
LF07	0.8N·m to 1N·m	10mm												
LF10	0.7N·m to 1N·m	14mm												
LF13	1 N·m to 1.5 N·m	16mm												
7		<p>Confirmation of Waterproof Performance After connector assembly procedure is completed, compress air in to the connector from the mating side under 17.6 kPa for 30 seconds check that no air leaks out of the connector.</p>												

◆ Cable Specifications (Reference)

No. of contact	3 pos.	4 pos.	6 pos.	12 pos.	20 pos.	11 pos.			
Conductor	Material							Tin plated soft copper wire	
	Size (mm)	φ0.18	φ0.26	φ0.16	φ0.16	φ0.16	φ0.26	φ0.16	
	Construction	20 / φ0.18 mm dia.	20 / φ0.26 mm dia.	7 / φ0.16 mm dia.	7 / φ0.16 mm dia.	7 / φ0.16 mm dia.	26 / φ0.26 mm dia.	7 / φ0.16 mm dia.	
	Size (AWG)	20 AWG	16 AWG	26 AWG	26 AWG	26 AWG	16 AWG	26 AWG	
	Sectional area	0.5	1.25	0.14	0.14	0.14	1.25	0.14	
Insulator	Diameter (mm)	φ0.98	φ1.5	φ0.48	φ0.48	φ0.48	φ1.5	φ0.48	
	Thickness (mm)	φ1.5 (Standard)	φ2.1 (Standard)	φ0.88 (Standard)	φ0.9 (Standard)	φ0.9 (Standard)	φ2.1 (Standard)	φ0.95 (Standard)	
Shield	Material							Tin plated soft copper wire	
	Density	85%	80% or more	85%	80% or more	80% or more	80% or more		
	Diameter (mm)	φ3.6	φ5.5	φ3.4	φ4.2	φ5.1	φ6.7		
Jacket	Diameter (mm)	φ5±0.2	φ7.3±0.2	φ5±0.2	φ7.3±0.2	φ8.7±0.2	φ8.7±0.2		

Remarks : The cable satisfies required specifications for UL specification.

Notes : The cable pull and twisting strength, waterproof tightness and other characteristics may differ, depending on the cable structure, please confirm before the use.



HIROSE ELECTRIC CO.,LTD.

2-6-3,Nakagawa Chuoh,Tsuzuki-Ku,Yokohama-Shi 224-8540,JAPAN
 TEL: +81-45-620-3526 Fax: +81-45-591-3726
<http://www.hirose.com>
<http://www.hirose-connectors.com>