

D.C. Milli-Ohm Meter

GOM-804 & GOM-805

USER MANUAL



ISO-9001 CERTIFIED MANUFACTURER

GW INSTEK

This manual contains proprietary information, which is protected by copyright. All rights are reserved. No part of this manual may be photocopied, reproduced or translated to another language without prior written consent of the Good Will company.

The information in this manual was correct at the time of printing. However, Good Will continues to improve products and reserves the right to change specifications, equipment, and maintenance procedures at any time without notice.

Good Will Instrument Co., Ltd.

No. 7-1, Jhongsing Rd., Tucheng Dist., New Taipei City 236, Taiwan.

Table of Contents

SAFETY INSTRUCTIONS	5
Safety Symbols	5
Safety Guidelines	6
GETTING STARTED	9
GOM-804/805 Characteristics.....	10
Key Features	13
Model Lineup	14
Front Panel Overview	15
TFT-LCD Overview	19
Rear Panel Overview	21
Set Up	23
MEASUREMENT	27
Resistance Measurement	29
Compare Function.....	41
Binning Function.....	46
Temperature Measurement	50
Temperature Compensation	52
Temperature Conversion	56
Measurement Settings	60
System Settings	69
HANDLER/SCAN INTERFACE	78
Handler Overview	79
Pin Definitions for the Handler Interface.....	81
Scan Overview.....	83
Configure Interface	91
SAVE/RECALL.....	100
COMMAND OVERVIEW	103
Command Syntax	103
Command List.....	106

General Commands.....	109
Compare Commands.....	113
Binning Commands.....	118
Temperature Compensate Commands	123
Temperature Conversion Commands	124
Temperature Commands	126
Scan Commands	127
Source Commands	131
Meas. Setup Commands	132
System Commands.....	137
Memory Commands	142
Status Commands	144
IEEE 488.2 Common Commands.....	145
Status system	148
FAQ	149
APPENDIX.....	150
Function Selection Combinations	151
Temperature Measurement	152
Specifications	155
Dimensions	158
Declaration of Conformity	159
INDEX	160

S SAFETY INSTRUCTIONS

This chapter contains important safety instructions that you must follow when operating the GOM-804/805 or when keeping it in storage. Read the following before any operation to insure your safety and to keep the GOM-804/805 in the best possible condition.

Safety Symbols

These safety symbols may appear in this manual or on the GOM-804/805.



WARNING

Warning: Identifies conditions or practices that could result in injury or loss of life.



CAUTION

Caution: Identifies conditions or practices that could result in damage to the instrument or to other properties.



DANGER High Voltage



Attention Refer to the Manual



Protective Conductor Terminal



Earth (ground) Terminal



Do not dispose electronic equipment as unsorted municipal waste. Please use a separate collection facility or contact the supplier from which this instrument was purchased.

Safety Guidelines

General Guideline



CAUTION

- Do not place any heavy objects on the instrument.
- Avoid severe impact or rough handling that leads to damaging the instrument.
- Do not discharge static electricity to the instrument.
- Use only mating connectors, not bare wires, for the terminals.
- Do not disassemble the instrument unless you are qualified as service personnel.

(Note) EN 61010-1:2010 specifies the measurement categories and their requirements as follows. The GOM-804/805 doesn't fall under category II, III or IV.

- Measurement category IV is for measurements performed at the source of low-voltage installation.
- Measurement category III is for measurements performed in the building installation.
- Measurement category II is for measurements performed on the circuits directly connected to the low voltage installation.

Power Supply



WARNING

- AC Input voltage: 100 - 240 V AC, 50 - 60Hz, 25VA
- The power supply voltage should not fluctuate more than 10%.
- Connect the protective grounding conductor of the AC power cord to an earth ground, to avoid electrical shock.

Cleaning the GOM-804/805

- Disconnect the power cord before cleaning.
- Use a soft cloth dampened in a solution of mild detergent and water. Do not spray any liquid into the instrument.
- Do not use chemicals or cleaners containing harsh material such as benzene, toluene, xylene, and acetone.

Operation Environment

- Location: Indoor, no direct sunlight, dust free, almost non-conductive pollution (Note below)
- Temperature Range: 0~35°C, Relative Humidity: <80%RH; >35°C, Relative Humidity: <70%RH
- Altitude: < 2000m
- Operating Environment: 0°C to 40°C (operation)
- Pollution Degree 2

(Note) EN 61010-1:2010 specifies the pollution degrees and their requirements as follows. The GOM-804/805 falls under degree 2. Pollution refers to “addition of foreign matter, solid, liquid, or gaseous (ionized gases), that may produce a reduction of dielectric strength or surface resistivity”.

- Pollution degree 1: No pollution or only dry, non-conductive pollution occurs. The pollution has no influence.
- Pollution degree 2: Normally only non-conductive pollution occurs. Occasionally, however, a temporary conductivity caused by condensation must be expected.
- Pollution degree 3: Conductive pollution occurs, or dry, non-conductive pollution occurs which becomes conductive due to condensation which is expected. In such conditions, equipment is normally protected against exposure to direct sunlight, precipitation, and full wind pressure, but neither temperature nor humidity is controlled.

**Storage
Environment**

- Location: Indoor
- Storage Conditions: -10°C to 70°C
- Temperature Range: $0\sim 35^{\circ}\text{C}$, Relative Humidity: $< 90\%\text{RH}$; $> 35^{\circ}\text{C}$, Relative Humidity: $< 80\%\text{RH}$

Disposal



Do not dispose this instrument as unsorted municipal waste. Please use a separate collection facility or contact the supplier from which this instrument was purchased. Please make sure discarded electrical waste is properly recycled to reduce environmental impact.

Power cord for the United Kingdom

When using the instrument in the United Kingdom, make sure the power cord meets the following safety instructions.

NOTE: This lead / appliance must only be wired by competent persons



WARNING: THIS APPLIANCE MUST BE EARTHED

IMPORTANT: The wires in this lead are coloured in accordance with the following code:

Green/ Yellow: Earth

Blue: Neutral

Brown: Live (Phase)



As the colours of the wires in main leads may not correspond with the coloured marking identified in your plug/appliance, proceed as follows:

The wire which is coloured Green & Yellow must be connected to the Earth terminal marked with either the letter E, the earth symbol \oplus or coloured Green/Green & Yellow.

The wire which is coloured Blue must be connected to the terminal which is marked with the letter N or coloured Blue or Black.

The wire which is coloured Brown must be connected to the terminal marked with the letter L or P or coloured Brown or Red.

If in doubt, consult the instructions provided with the equipment or contact the supplier.

This cable/appliance should be protected by a suitably rated and approved HBC mains fuse: refer to the rating information on the equipment and/or user instructions for details. As a guide, a cable of 0.75mm^2 should be protected by a 3A or 5A fuse. Larger conductors would normally require 13A types, depending on the connection method used.

Any exposed wiring from a cable, plug or connection that is engaged in a live socket is extremely hazardous. If a cable or plug is deemed hazardous, turn off the mains power and remove the cable, any fuses and fuse assemblies. All hazardous wiring must be immediately destroyed and replaced in accordance to the above standard.

G ETTING STARTED

This chapter describes the GOM-804/805 in a nutshell, including its main features as well as its front and rear panels. After going through the panel overview, follow the Power-up sequence before attempting to use the instrument.

Please note the information in this manual was correct at the time of printing. However as GW Instek continues to improve its products, changes can occur at any time without notice. Please see the GW Instek website for the latest information and content.



Characteristics	GOM-804/805 Characteristics	10
	Key Features	13
	Model Lineup	14
Panel Overview	Front Panel Overview	15
	TFT-LCD Overview	19
	Rear Panel Overview	21
Setup	Tilt Stand	23
	Power Up	24
	4 Wire Kelvin Connection	25
	Zeroing (Relative Function)	26

GOM-804/805 Characteristics

GOM-804 and GOM-805 are modern high precision programmable DC Milli-ohm meters suitable for low resistance measurements of switches, relays, connectors, PCB tracks and a variety of other devices. The meters feature a color TFT-LCD screen with easy-to-read measurement results. With the easy-to-use features, superior performance and automatic test interfaces, these meters are dependable instruments for resistance measurements.

Easy to Use Features

Each test function on the GOM-804/805 can be easily activated by pressing a single front panel key. All the settings and measurement results are displayed and set on the TFT-LCD panel at the same time making each function naturally intuitive to use.

Each primary and secondary measurement result is displayed prominently on the display along with any corresponding settings. For sequential measurement results, such as those from the scan or binning function, are tabulated in an intuitive and easy-to-read format.

In addition, the meters can recall previously used settings upon startup, allowing the meter to be ready the next time it used in a matter of moments. The meters can also save or recall up to 20 sets of function settings.

Performance

The GOM-804/805 has nine selectable measurement ranges from $5\text{m}\Omega$ to $5\text{M}\Omega$, a constant current source of $1\mu\text{A}$ to 1A , an accuracy of up to 0.05% , a $0.1\mu\Omega$ resolution and performs measurements using four wire Kelvin connections for accurate, consistent measurements.

The ability to choose between high accuracy measurements at 10 samples/sec (full scale at 50000 counts) or high speed measurements at 60 samples/sec (full scale at 50000 counts), allows the GOM-804/805 the flexibility to fulfill a number of different measurement roles.

Advanced Temperature Measurements	<p>The GOM-804/805 has a number of advanced temperature functions that can be used with the optional temperature probe, PT-100.</p> <p>The temperature compensation function can extrapolate what the resistance of a DUT will be at a desired temperature, if the temperature coefficient of the DUT and the resistance of the DUT at ambient temperature are known.</p> <p>The temperature conversion function can be used to extrapolate what the temperature rise of a DUT will be at specified resistance if the initial resistance, initial temperature and the constant for the DUT are known.</p>
Drive Signals	<p>The GOM-805 can select a number of different drive signals to suit a number of different measurement scenarios, for example the Pulse setting can be used to cancel the effects of thermoelectric EMF on the measurement results.</p>
Dry Circuit Testing	<p>Dry circuit testing allows the GOM-805 to measure the contact resistance of switches and connectors according to the DIN IEC 512 and ASTM B539 standards. The open circuit voltage will not exceed 20mV in this mode to prevent the oxidization layer on metal switches and connector points from breakdown. GOM-805 only.</p>
Automatic Testing	<p>For automatic testing The GOM-804/805 has a handler interface designed for automatic testing. The handler interface outputs the status of PASS, FAIL, HI, LO, READY and EOT signals and inputs a trigger control signal. Automatic testing is used with the binning, compare and scan functions.</p> <p>For computer control applications, RS-232 and USB are standard remote interfaces, with GPIB as standard only for the GOM-805 and GOM-804G.</p>

Applications

- Production testing for contact resistance of switches, relays, connectors, cables and printed circuit boards and other low resistance devices.
 - Component testing of resistors, motors, fuses and heating elements.
 - Incoming inspection and quality assurance testing.
 - Conductivity evaluation for product design.
-

Key Features

- 50,000 counts
 - Measurement Range: 5m Ω ~5M Ω
 - Accuracy of up to 0.05%
 - Compare function
 - Binning function
 - Manual or Auto-ranging
 - Continuous or Triggered measurement modes
 - Temperature measurement, temperature compensation and temperature conversion
 - Four-wire Kelvin measurement method
 - Selectable power-on settings
 - Diode test
 - Alarm settings for function-specific PASS/FAIL test results
 - Sampling rate: 10 or 60 sampling/sec
 - Standard interfaces:
USB/RS232/Scan/Handler/GPIB(GOM-805,
GOM-804G)
 - Save/Recall settings: 20 memory sets
 - External I/O logic function
-

Model Lineup

Feature / Model	GOM-804	GOM-804G*	GOM-805
Ohm Measurement	✓	✓	✓
Compare Function	✓	✓	✓
Diode Measurement	✓	✓	✓
Temp. Compensation	✓	✓	✓
Temp. Conversion	✓	✓	✓
Temp Measurement	✓	✓	✓
Dry Circuit	✗	✗	✓
Drive Selection	✗	✗	✓
Binning Function	✗	✗	✓
Interface			
GPIB Interface	✗	✓	✓
RS-232 Interface	✓	✓	✓
USB Device Interface	✓	✓	✓
Handler/EXT IO/Scan Interface	✓	✓	✓
Temperature Sensor Interface	✓	✓	✓

* The GOM-804G is simply the GOM-804 with the factory-installed GPIB option. Please note that the GPIB option cannot be user-installed on the GOM-804. The option must be ordered prior to purchase.

Front Panel Overview

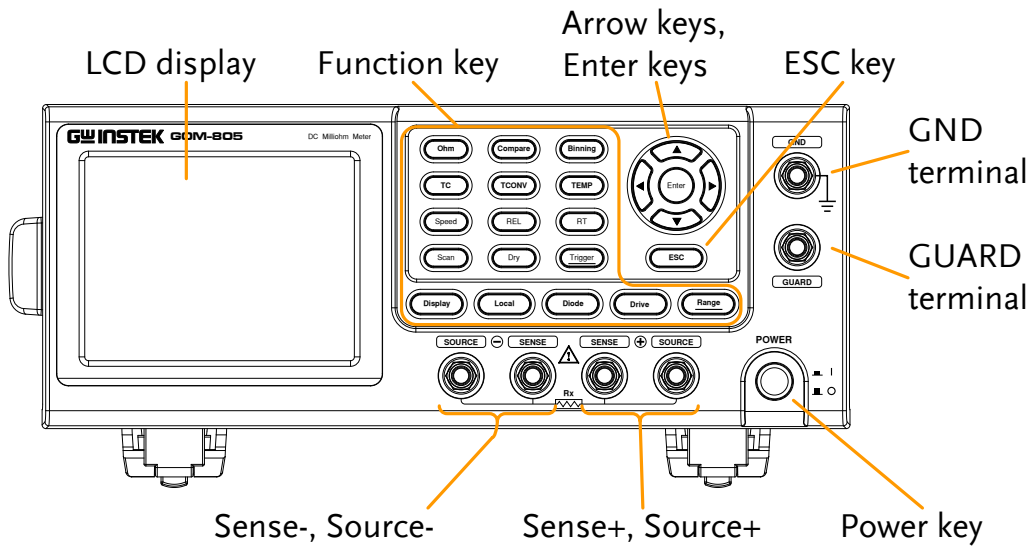

Power Switch

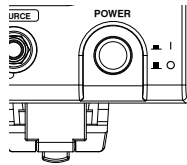

Turns On or Off the main power. For details about the power up sequence, see page 24.

Measurement Terminals

Source, Sense Terminals

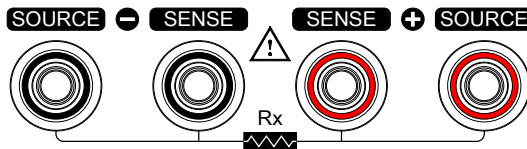

Sense + and Sense - terminals.

Current source terminals: Source + and Source -.



When measuring components with polarity, connect Source+ to the positive potential and connect Source- to the negative potential of the component.



Discharge any DUT before measurement to avoid damaging the GOM-804/805.

GND Terminal

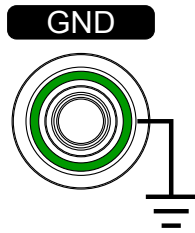

Connect the GND (ground) terminal to the earth ground.

GUARD Terminal



The GUARD terminal has the same potential as earth, but cannot be substituted for it. Connect the GUARD terminal to the cable shield layer of the test leads to help reduce noise.

Function Keys



The Ohm key activates the resistance measurement function.



The Compare key activates the comparator function.



The Binning key activates the binning function to grade the DUTs into eight bins according to the tolerance settings. GOM-805 only.



The TC key activates the TC (temperature compensation) function which calculates the resistance of a DUT at a specified temperature given the resistance of the DUT at the ambient temperature and the temperature coefficient of the DUT is known.



The TCONV (Temperature Conversion) function calculates the temperature of a DUT given an initial temperature, initial resistance, measured resistance and a constant (inferred zero resistance temperature) for the DUT.



The TEMP key activates the temperature measurement function.

Speed	The Speed key toggles between 10 samples per second and 60 samples per second (Slow rate and Fast rate).
REL	The REL key is used to perform a zero adjustment to the test leads or a DUT.
RT	The RT key is used to display the real-time (not averaged) measured resistance value.
Scan	The Scan key is used to turn on the Scan function.
Dry	The Dry key is used to turn on the dry circuit measurement mode which allows the GOM-805 to measure the contact resistance of switches and connectors according to DIN IEC 512 and ASTM B539 standards. GOM-805 only.
Trigger	<p>When in the internal trigger mode, pressing the Trigger key will turn on the external trigger mode. When in the external trigger mode, pressing the Trigger key will perform a manual trigger.</p> <p>A long press of the Trigger key when in external trigger mode will reset the trigger mode back to the internal trigger mode.</p>
Display	The Display key toggles between the standard display mode and the simplified display mode (sans menus and display icons).
Local	The LOCAL key will switch the milliohm meter between local and remote mode.
Diode	The Diode key is used to turn on the Diode measurement function.

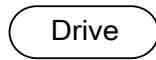

+

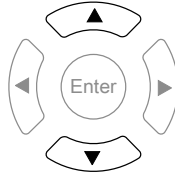

The Drive key in conjunction with the up/down arrow keys is used to select the measuring signal: DC+, DC-, Pulse, PWM, Zero and Standby. In particular, the Zero setting can be used as a +/-10mV DC voltmeter to measure the EMF of passive components. The Standby, on the other hand, is used to break off Relay of Force+/- without outputting test current, and none of measurements will be executed.

See page 33 for details. GOM-805 only. The drive signal is fixed to DC+ and Standby on the GOM-804.

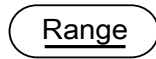

Long pressing the Range key will activate the auto ranging mode.



+

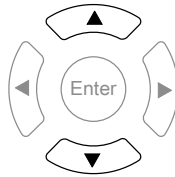

The Range key in conjunction with the up/down arrow keys is used to select the resistance measurement range.

When in auto ranging mode, pressing the Range key will activate the manual ranging mode.



The ESC key cancels the current setting and returns the cursor to its default location or returns to the previous menu, depending on the circumstances.

Arrow Keys,
Enter Key

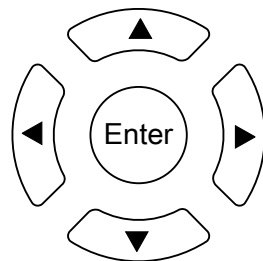

The arrow keys and Enter key are used to edit parameters, to navigate the menu system and to select parameter ranges.

TFT-LCD Overview

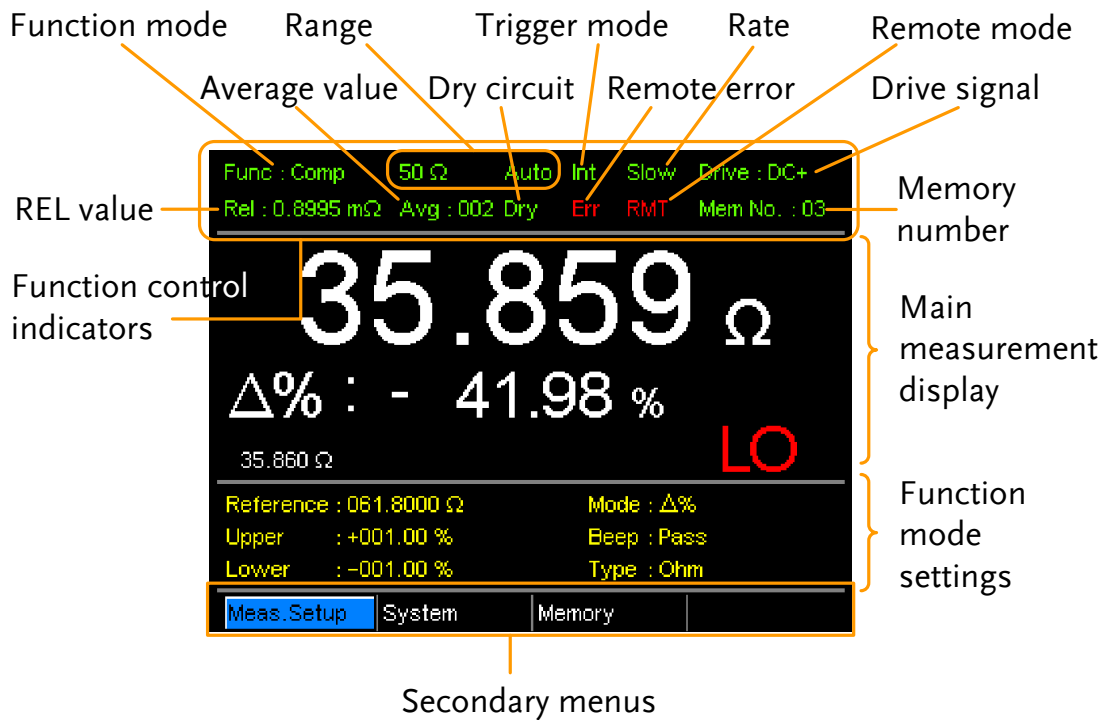

Function Control Indicators

The function control indicators show all the currently active settings for the selected function mode:

Func	Currently selected function mode
Range	The measurement range. Auto indicates that auto ranging is active
Trigger mode	Int/Ext
Rate	Slow/Fast
Drive:	DC+, DC-, Pulse, PWM, Zero, Standby
Rel	Shows the relative (nominal) reference value
Avg	Number of samples used for the Average function.
Dry	Indicates that the dry circuit function is active
Err	Indicates a remote command error

	RMT	Indicates that the unit is in remote control mode
	Mem No.	Indicates which memory setting has been recalled
Main Measurement Display	Shows all measurement results for the selected function mode.	
Function Mode Settings	Shows any function mode-specific settings.	
Secondary Menus	The secondary menus show global menus (Meas. Setup), System, Memory) as well as function-specific secondary menus.	
	Meas. Setup	Goes to the global Measurement Setup menu.
	System	Goes to the global System menu
	Memory	Allows you to save, recall and clear memory settings.
	View	Shows the all results for all the channels when a scan has finished.
	Clear	Clears the measurement results in the Binning function when the display mode is set to Count.

Rear Panel Overview

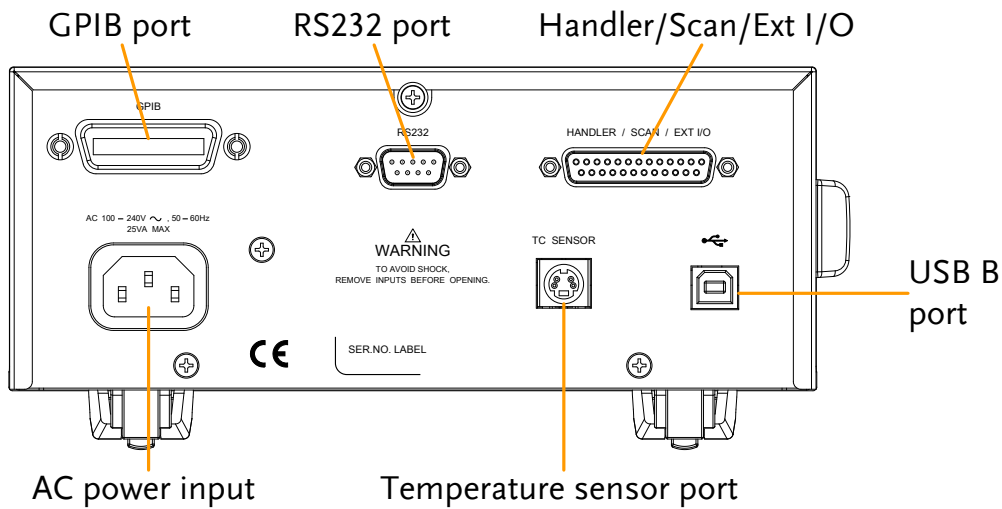

AC Input

AC 100 - 240V ~, 50 - 60Hz
25VA MAX

Accepts the power cord. AC 100 - 240Vac; 50 - 60Hz.

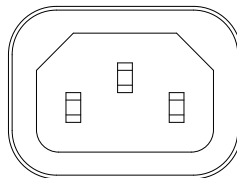

For the power up sequence, see page 24.

RS-232 Port

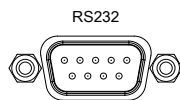

Accepts an RS-232C cable for remote control; DB-9 male connector.

For remote control details, see page 93.

GPIB Port

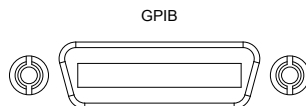

Accepts a GPIB cable for remote control. See page 94 for details.

USB Device Port

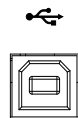

USB device port for remote control. See page 91 for details.

Handler / Scan / EXT I/O Port

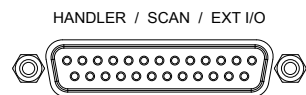

The Handler / Scan / EXT I/O port is used to output pass/fail/high/low comparison results. This port is also used for the user-programmable EXT I/O pins.

Temperature
Sensor Port

TC SENSOR



The temperature sensor input is for the optional PT-100 temperature probe.

Set Up

Tilt Stand

Tilt

To tilt, pull the legs forward, as shown below.

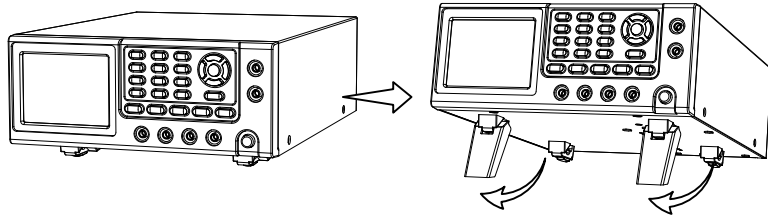

Stand Upright

To stand the unit upright, push the legs back under the casing as shown below.

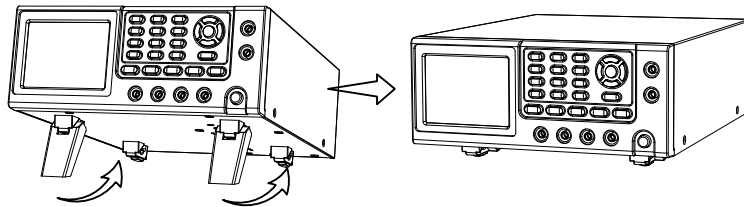

Power Up

1. Connection Ensure that the input AC power voltage is within the range of 100~240 V.

Connect the power cord to the AC Voltage input.

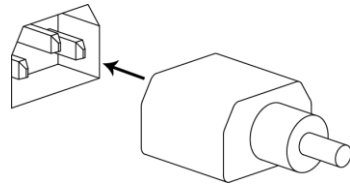

CAUTION

Ensure the ground connector of the power cord is connected to a safety ground. This will affect the measurement accuracy.

1. Power up Press the main power switch on the front panel.

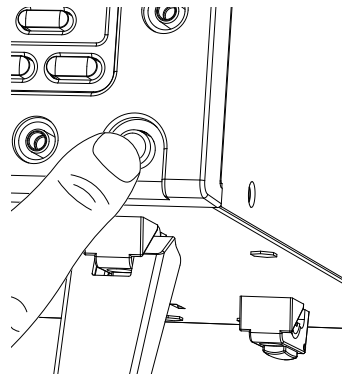

The display will light up and show the last setting used before the last shut down.

Example:
Resistance
measurement
mode



4 Wire Kelvin Connection

Background The GOM-804/805 uses 4 wire Kelvin connections for accurate measurements.

Connection Diagram

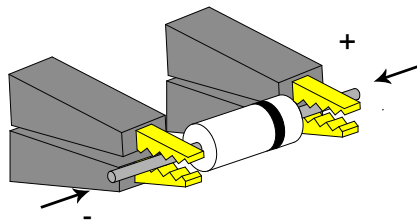
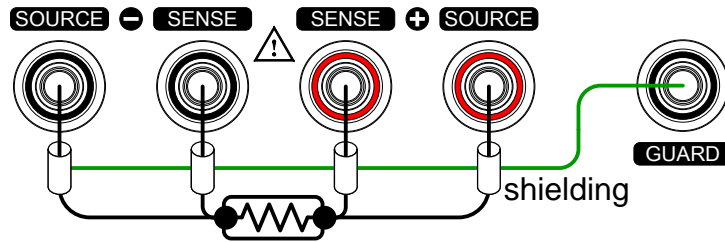

Description	Source +	The Source + terminal carries the measuring current source. It is connected to the + side of the DUT.
	Source -	The Source - terminal accepts the signal return current and connects to the - side of the DUT.
	Sense +	Monitors the positive (+) potential.
	Sense -	Monitors the negative (-) potential.
	Guard	Grounds the shielding layer of the test lead cables to reduce noise.
	GND	Provides a reference ground for the GOM-804/805.

Zeroing (Relative Function)

Background

The Relative function is used to perform a zero adjustment on the test leads.

After the Relative value is pre-set, each measurement that is displayed is equal to the actual value minus the relative preset value.



Note

The Relative function cannot be used with the Scan or Diode functions.

1. Short the test cables

Short the test cables together as shown in the diagram below:

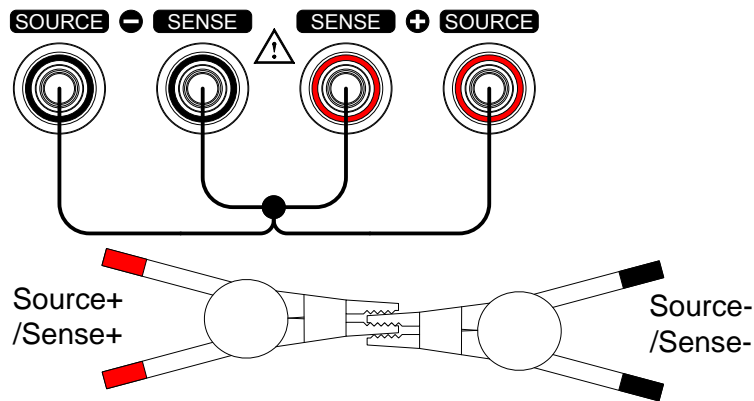

2. Set the Reference value

Press the **REL** key.

3. Relative mode display appears

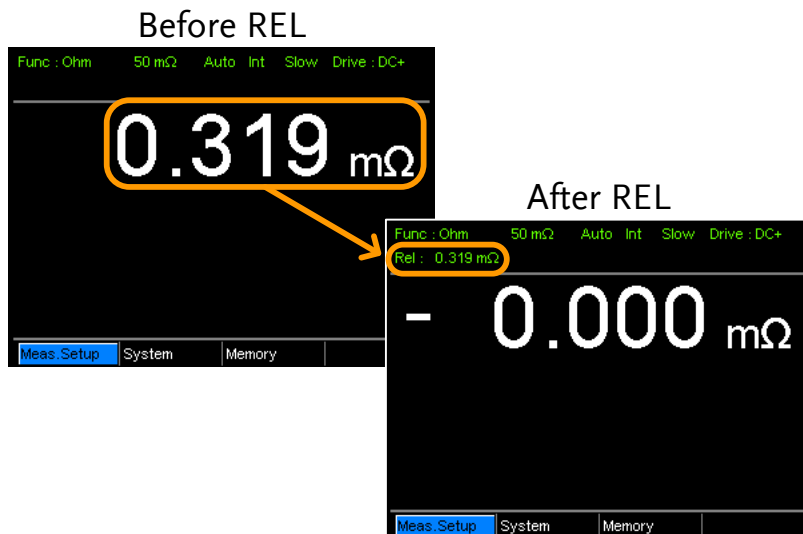

Rel: Indicates the Relative function is active

M EASUREMENT

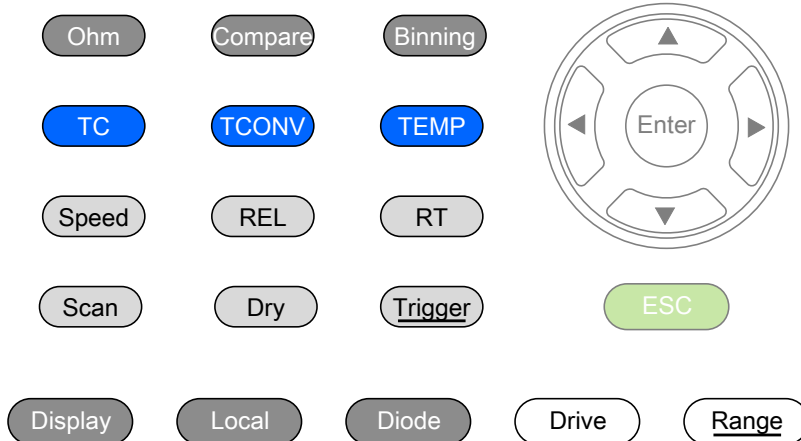

Resistance	Resistance Measurement	29
	Select the Resistance Range	30
Drive Signal	Measuring Signal (Drive) Overview.....	31
	Select Measuring Signal (Drive).....	33
Rate	Select Measurement Rate.....	34
Display Mode	Display Mode	35
Real-Time	View Real-Time Measurement.....	36
Dry-Circuit	Dry-Circuit Measurement	37
Trigger	Using the Trigger Function	38
Diode	Diode Function.....	40
Compare Function	Compare Function.....	41
Binning Function	Binning Function.....	46
Temperature Measurement	Temperature Measurement	50

Temperature Compensation	Temperature Compensation	52
--------------------------	--------------------------------	----

Temperature Conversion	Temperature Conversion	56
------------------------	------------------------------	----

Measurement Settings	Average Function	60
	Measure Delay	61
	Trigger Delay	63
	Trigger Edge	64
	Temperature Unit	65
	Ambient Temperature	66
	Line Frequency	67
	PWM Setting	68

System Settings	System Information	69
	Power On Status Setup	70
	Interface	71
	Brightness	72
	User Define Pins	73
	Handler Mode	74
	Beep	76
	High Voltage Protection	77

Resistance Measurement

1. Select the Resistance function.

Press **Ohm** to access the Resistance measurement mode.

2. Resistance mode display appears.

Ohm measurement function indicator

Resistance range and mode

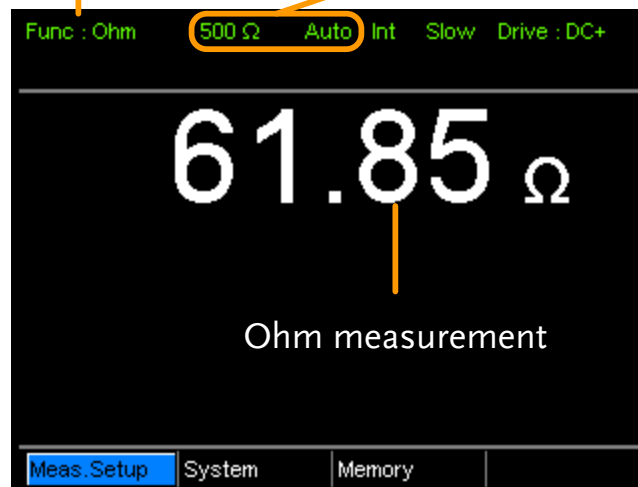

3. Connect the test lead and measure

4-wire resistance:

Use the SOURCE + and the SOURCE - terminal for measurement, and the SENSE +, and SENSE - terminal for sensing.

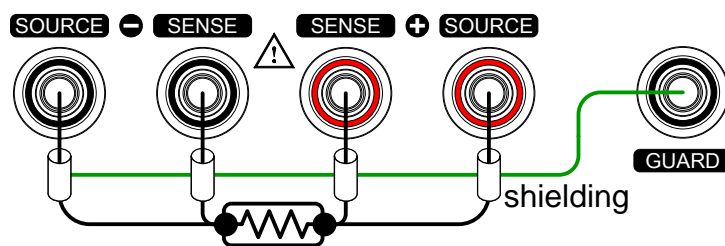

 Note

When switching between measurement ranges, please allow a moment for the circuits to settle before measuring.

Select the Resistance Range

Background The resistance range can be used with normal resistance measurement as well as the temperature compensation function.

Manual Press the **Range** key and use the up and down arrow keys to manually select the resistance range.



Auto Range Long press the **Range** key to turn on automatic ranging.

Range, Auto range



Selection List	Range	Resolution
	5mΩ	0.1uΩ
	50mΩ	1uΩ
	500mΩ	10uΩ
	5Ω	100uΩ
	50Ω	1mΩ
	500Ω	10mΩ
	5kΩ	100mΩ
	50kΩ	1Ω
	500kΩ	10Ω
	5MΩ	100Ω



Note

For detailed specifications, please see the specifications on page 155.

Measuring Signal (Drive) Overview

Background Resistance measurement has 6 different measuring signals that can be applied to obtain a resistance measurement: DC+, DC-, Pulse, PWM, Zero and Standby. These 6 signals are described in below.



Note

The Drive function is only applicable to the GOM-805. The Drive signal for the GOM-804 is fixed to DC+ and Standby.

DC+

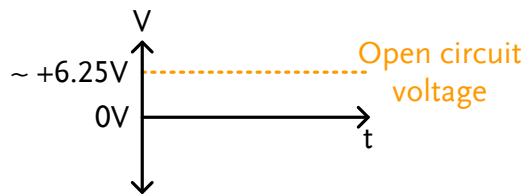

Default drive signal.

DC-

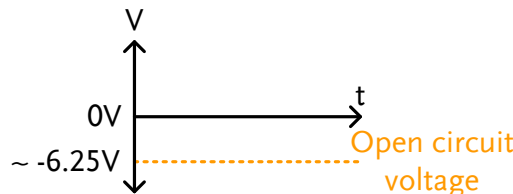

Negative drive signal.

Pulse

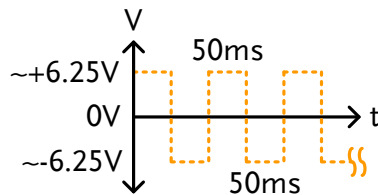

This mode can be used to eliminate the thermoelectric EMF formed on the contact between a test lead and a DUT.

PWM

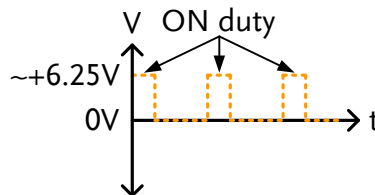

This mode can be used to avoid heating up the DUT and thus avoid having the measurement accuracy compromised on temperature-sensitive DUTs.

Standby

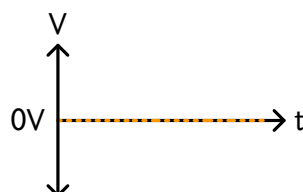

The Standby is used to break off Relay of Force+/- without outputting test current, and none of measurements will be executed.

Note: Standby mode only applies to hardware with the latest PCB board. Refer to page 69 for details.

Zero

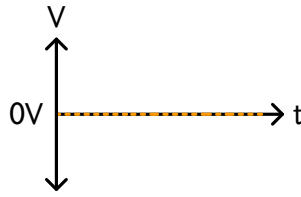

In this mode, GOM-805 outputs no measuring signal on the Source loop; therefore, the Sense loop can be used as a voltage meter which can measure up to +/-10mV for thermoelectric EMF measurement. This function is useful for measuring the V_{emf} of thermocouple wires.

A note about Thermoelectric EMF

When making low resistance measurements, thermoelectric electromotive force (V_{emf}) can affect measurement accuracy. V_{emf} is created at the junction of two dissimilar metals, such as the contact point of a test lead and the pin of a DUT. V_{emf} adds a small but measurable voltage to the measurement.

There are primarily two different methods to compensate for V_{emf} in low resistance measurements: Offset Compensation and V_{emf} Cancelling. The GOM-805 uses V_{emf} Cancelling with the pulse drive signal setting (see page 33).

The Pulse drive mode supplies a positive and a negative measurement current source.

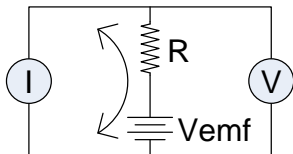

This produces a positive and negative measurement voltage across the DUT, which also includes the V_{emf} ($V_1 + V_{emf}$ & $V_2 + V_{emf}$).

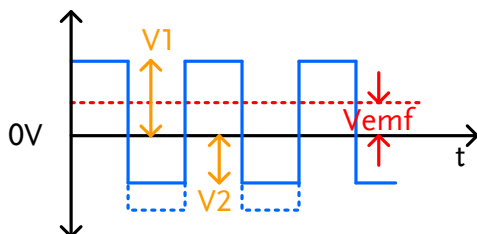

To cancel the V_{emf} , V_2 is deducted from V_1 and divided by 2 to get the average measurement, as shown in the formula below:

$$V_x = \frac{(V_1 + V_{emf}) - (V_2 + V_{emf})}{2}$$

Where V_x = measured voltage sans V_{emf} .

Select Measuring Signal (Drive)

Background Resistance measurement has 6 different measuring signals that can be applied to obtain a resistance measurement: DC+, DC-, Pulse, PWM, Zero and Standby.



Note

The Drive function is only applicable to the GOM-805. The drive signal for the GOM-804 is fixed to DC+ and Standby.

The Drive function cannot be used with the Scan or Diode functions. In addition, the “Zero” drive setting is only available with the Ohm measurement function.

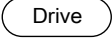
- 1. Select Drive** Press the  key and use the up and down arrow keys to select a drive signal.

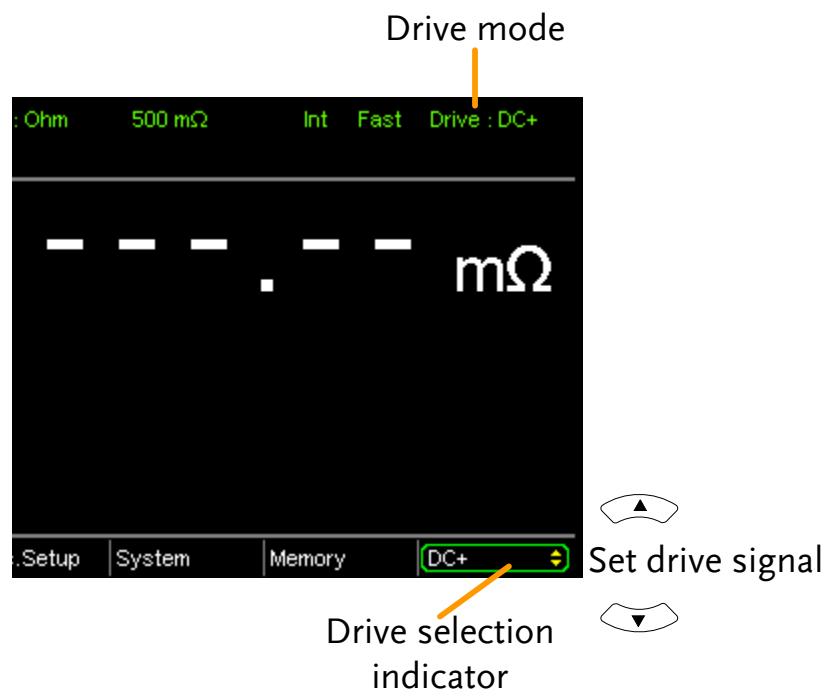

Drive Range DC+, DC-, Pulse, PWM, Zero, Standby

Select Measurement Rate

Background

The resistance measurement speed has 2 ranges: slow and fast. Slow speed is the most accurate with 10 measurements/second. Fast speed has 60 measurements/second. Both have the same measurement resolution.

The rate selection function is not applicable in Diode measurement mode. When the PWM drive signal is used or when the Scan function is activated, the only available rate setting is fast.

1. Select Rate

Press the  key to toggle between the Slow and Fast rates.

Measurement rate



Func : Ohm 500 mΩ Int **Fast** Drive : DC+

Display Mode

Background The Display key can be used to toggle between the normal and the simplified display mode. The simplified display mode clears all text, menus and function indicators from the screen except for the measurement and measurement mode indicators.

1. Toggle Display mode Press the  key to toggle the display between normal and simplified. The display will change accordingly.

Simplified Display Mode Example

Measurement mode

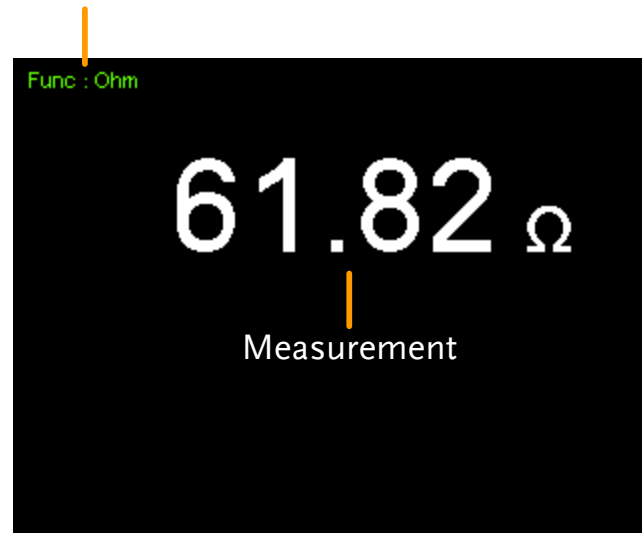

View Real-Time Measurement

Background When measurements are smoothed using the averaging function, the RT key can be used to view the real-time results in addition to the averaged results.

See page 60 for Average configuration.

1. Toggle Real-Time display

Press the  key to toggle the real-time display on or off.

The real-time measurement will appear in the bottom left-hand corner.



Real-time
measurement

Dry-Circuit Measurement

Background The Dry Circuit measurement function is used where the maximum open-circuit voltage must be kept to a minimum for applications such as measuring the contact resistance of switches, relays and connectors. The GOM-805 provides a maximum of up to 20mV in this mode.

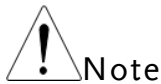

Note

Dry circuit testing is for switch and connector contact resistance. Switch and connector contact resistance measurement is in accordance with DIN IEC 512 and ASTM B539 which requires that the open circuit voltage of the measuring device should not exceed 20mV DC. Voltage at such low levels avoids the breakdown of any oxides that may be present on the contacts. In this mode the open circuit measuring voltage is limited <20mV, while modes like DC+ or pulse mode can have an open circuit measuring voltage as high as 6.25V.

The Dry Circuit function cannot be used with the Scan or Diode functions. In addition, when the Dry Circuit function is turned on, only 3 drive settings are available: DC+, DC- and Pulse.

Dry Limitations When the Dry Circuit measurement function is turned on, the measurement range is reduced. See the specifications for more details.

Range	Dry Mode	Rate
5mΩ	✗	
50mΩ	✗	
500mΩ	✓	Slow/Fast
5Ω	✓	Slow/Fast
50Ω	✓	Slow/Fast
500Ω	✗	
5kΩ	✗	
50kΩ	✗	
500kΩ	✗	

5MΩ **X**

1. Toggle Dry mode on or off

Press the **Dry** key to toggle the dry circuit measurement mode on or off.

The DRY function indicator will appear in the middle of the display when active.

Dry Circuit measurement mode indicator

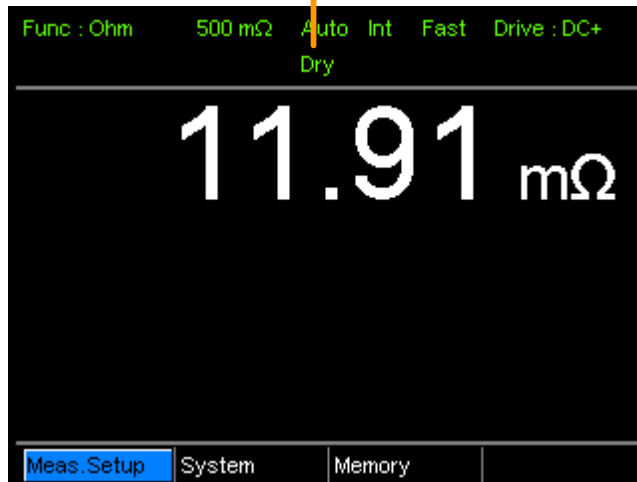

Using the Trigger Function

Background

The GOM-804/805 can use internal or manual triggering for the Resistance, Temperature, Temperature Compensation, Temperature Conversion, Binning, Handler and Scan modes. By default the GOM-804/805 is set to internal triggering mode.

1. Select Manual Trigger

Short press **Trigger** to switch to manual triggering mode.

The Ext indicator will be shown on the display when the manual trigger is active.

Trigger source



2. Manually Triggering Measurements

Short press the **Trigger** key each time you want to start a single measurement (when in the manual mode).

3. Internal Triggering

Long press **Trigger** to return the triggering mode back to internal mode.

The Int indicator will be shown on the display.

Internal trigger source



Diode Function

Background The Diode function can be used to measure the forward bias voltage of a diode under test.

1. Select the Diode function. Press  to access the Diode measurement mode.

2. Diode mode appears. Diode function indicator

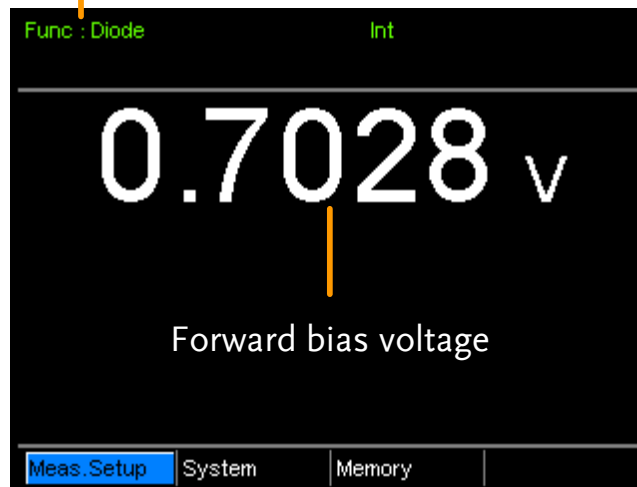

3. Connect the test lead and measure Connect the Sense+, Source+ to the anode.
 Connect the Sense-, Source- to the cathode.

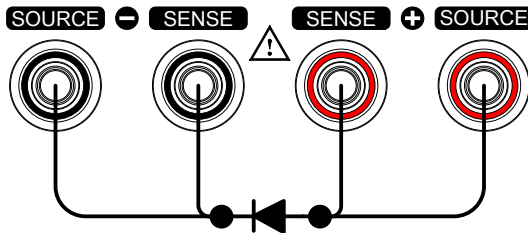

Compare Function

Background

The compare function compares a measured value to a “Reference” value that has an upper (HI) and lower (LO) limit. If the measured value is within the upper and lower limit, then the measured value is judged as IN.

There are three compare modes that can be used to make a judgment: ABS, $\Delta\%$ and $\%$ modes.

The ABS mode displays the absolute difference between the measured and the reference value (shown as Δ) and compares the measured value to the upper (HI) and lower (LO) limit. The upper and lower limits are set as absolute resistance values.

Compare function indicator

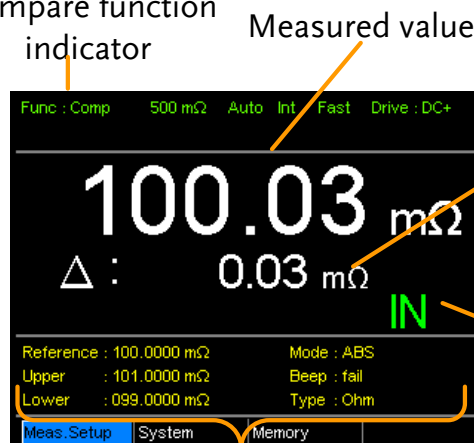

Absolute difference of measured value from Reference value

Pass/Fail judgment

Reference, limits, compare mode and beep mode

A measured value that falls within the upper and lower limits is considered IN (pass), a value that falls below the lower limits is considered LO, and a value that falls over the upper limit is a HI.

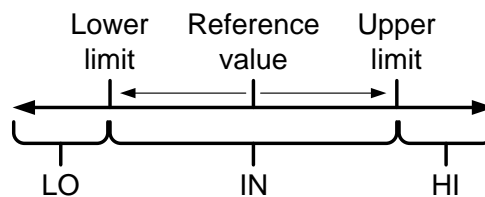

[Note that the reference value in the ABS mode is only for reference purposes and is not used to make a judgment.]

The $\Delta\%$ compare function displays the deviation of the measured value from the reference value as a percentage. $\{[(\text{Measured Value}-\text{Reference})/\text{Reference}]\%\}$.

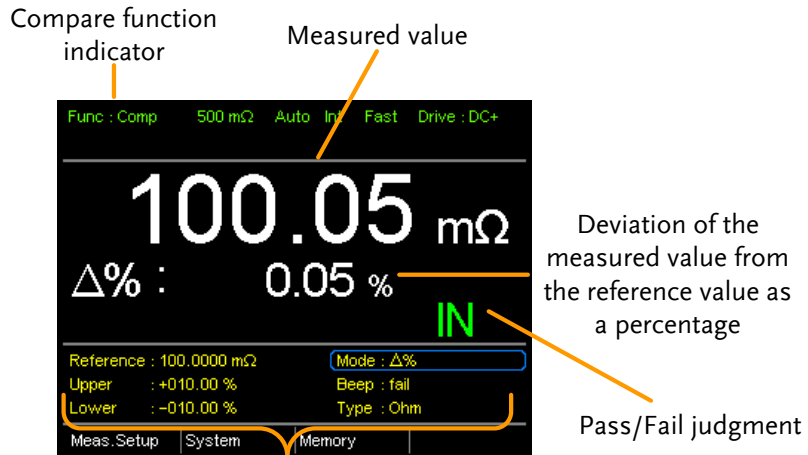

Reference, limits, compare mode and beep mode

The upper (HI) and low (LO) limits are set as a percentage *from* the reference value. (Identical to the % compare mode)

A measured value that falls within the upper and lower limits is considered IN (pass), a value that falls below the lower limits is considered LO, and a value that falls over the upper limit is a HI.

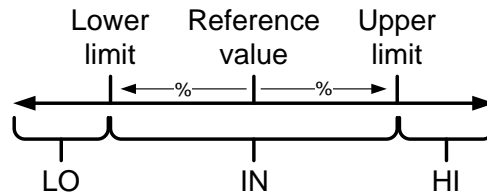

The % compare mode displays the measured value as a percentage of the reference value $[(\text{Measured Value}/\text{Reference Value})\%]$.

The upper (HI) and low (LO) limits are set as a percentage *from* the reference value. (Identical to the $\Delta\%$ compare mode)

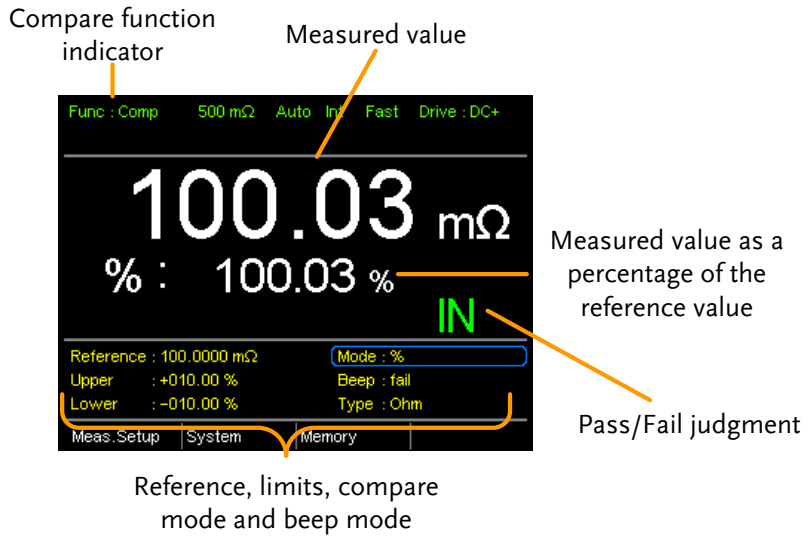

A measured value that falls within the upper and lower limits is considered IN (pass), a value that falls below the lower limits is considered LO, and a value that falls over the upper limit is a HI.

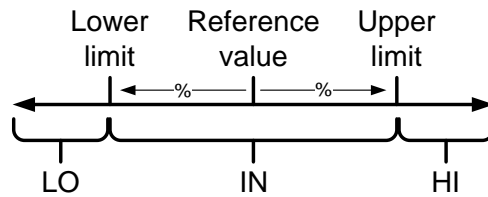

For all the compare modes, IN, HI or LO will be shown on the display for each judgment.

1. Select the compare function above. Press **Compare** to access the compare mode, as shown

2. Select the compare mode Use the arrow keys to navigate to the Mode setting. Press the Enter key to toggle the compare mode.

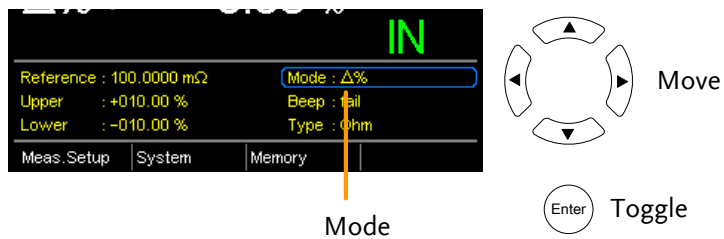

Range Abs, Δ, %, %

3. Reference value setting

Use the arrow keys to navigate to the Reference setting and press Enter.

Use the left and right arrow keys to select a digit. Use the up and down arrow keys to edit the value of the selected digit and the unit. Press Enter to confirm the setting.

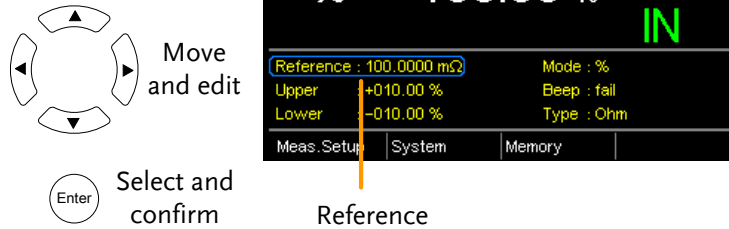

Range: 000.0001 ~ 999.9999
(mΩ/Ω/kΩ/MΩ)



Note

After setting the Reference value, the displayed Δ , % or $\Delta\%$ values will be changed to reflect the new Reference value setting.

4. Upper & lower limit setting

Use the arrow keys to navigate to the Upper or Lower limit setting and press Enter.

Use the left and right arrow keys to select a digit. Use the up and down arrow keys to edit the value of the selected digit. Press Enter to confirm the setting.

Repeat for the other limit (Upper or Lower).

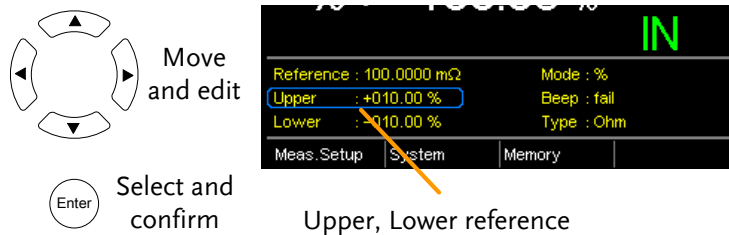

Setting Range: ABS mode: 000.0000 ~ 999.9999
(mΩ/Ω/kΩ/MΩ)
 $\Delta\%$ and % mode:
-999.99 ~ +999.99



Note

The upper limit must be higher than the lower limit. Not setting the upper limit higher than the lower limit is not allowed. Likewise the lower limit cannot be set higher than the upper limit.

5. Beep setting Use the arrow keys to navigate to the Beep setting.
Press Enter to toggle the beep setting.

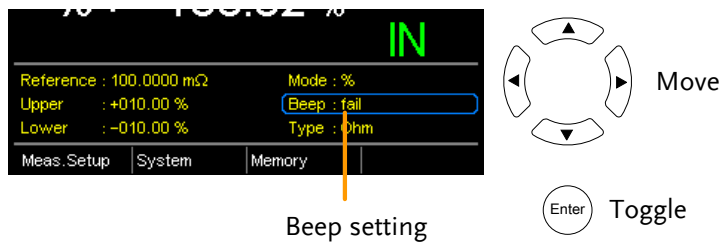

Beep Setting: Off, Pass, Fail



Note

The Beep setting can also be set from the System>Utility>Beep>Compare menu.

6. Type setting Use the arrow keys to navigate to the Type setting.
Press Enter to toggle the type setting.

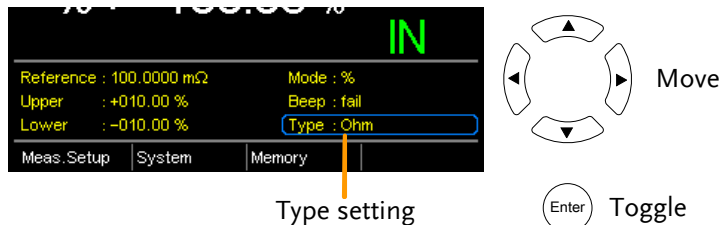

Type Setting: Ohm, TC



Note

The measured value is displayed according to Type setting is selected.

For TC function comparison, please make sure the relative TC setting is done. See page 52 respectively for details.

Binning Function

Background The Binning function is used to grade DUTs into eight different bins according to 8 sets of upper and lower limits. Two compare modes can be used in this function, ABS and $\Delta\%$ modes.

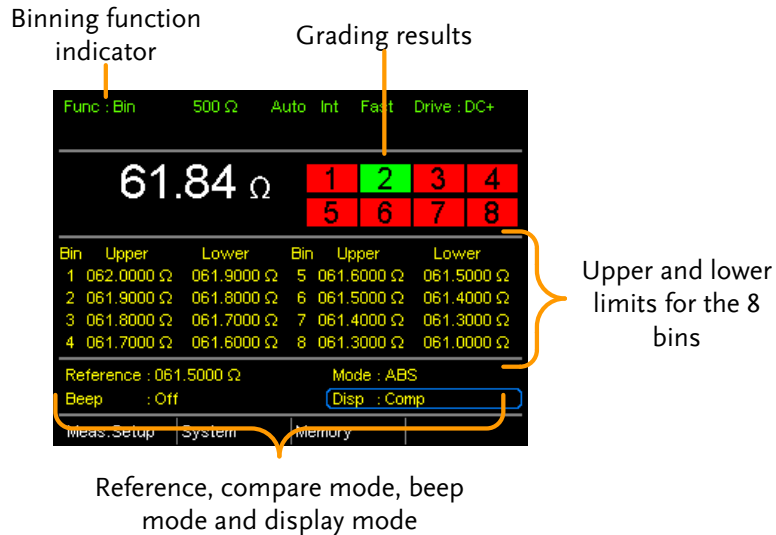

1. Select the Binning function

Press the **Binning** key to access this function.

2. Select the compare mode

Use the arrow keys to go to the Mode setting.

Press Enter to toggle between ABS or $\Delta\%$ compare modes.

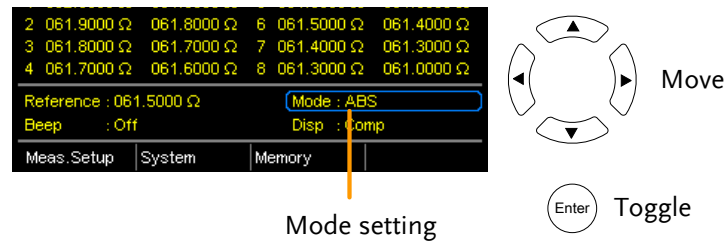

ABS Mode

The ABS mode allows you to set the upper and lower limits of each bin as absolute resistance values.

$\Delta\%$

The Delta % mode allows you to set the upper and lower limits of each bin as percentage value from the reference value.



Note

For further details on the ABS or $\Delta\%$ compare modes, see the description in the Compare section, page 41.

3. Reference value setting

Although the 8 bins have their own upper and lower limits, they still share a common reference value.

Use the arrow keys to go to the Reference setting and press Enter.

Use the left and right arrow keys to select a digit. Use the up and down arrow keys to edit the value of the selected digit and the unit. Press Enter to confirm the setting.

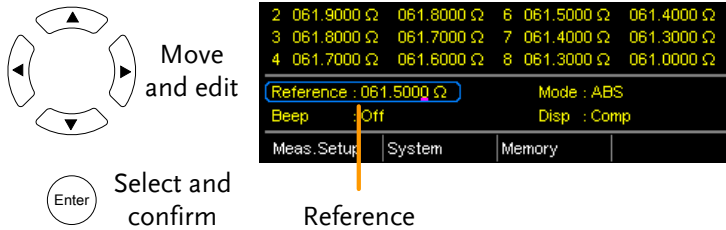

Range 000.0001 ~ 999.9999 (mΩ/Ω/kΩ/MΩ)

4. Upper & lower limit settings

Use the arrow keys to go to the upper limit of the first bin and press Enter.

Use the Left and Right arrow keys to select a digit. Use the Up and Down arrow keys to edit the value of the selected digit and unit. Press the Enter key to confirm the setting.

Repeat for the lower setting.

Repeat for the remaining bins.

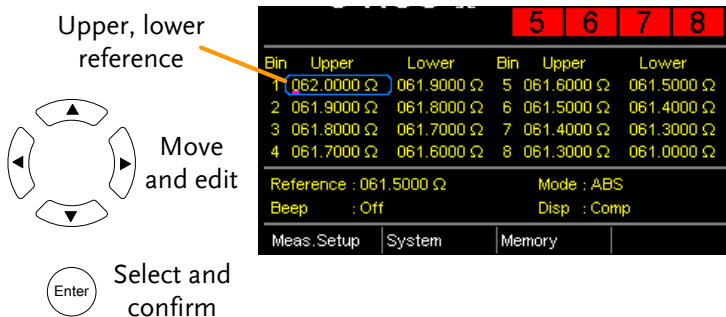

Setting range ABS mode: 000.0000~999.9999 (mΩ/Ω/kΩ/MΩ)
 $\Delta\%$ mode: -999.99 ~ +999.99



Note

The upper limit must be higher than the lower limit. Not setting the upper limit higher than the lower limit is not allowed. Likewise the lower limit cannot be set higher than the upper limit.

5. Beep setting

Use the arrow keys to navigate to the Beep setting. Press Enter to toggle the beep setting.

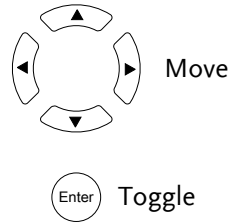

Beep setting

Beep Setting: Off, Pass, Fail



Note

The Beep setting can also be set from the System>Utility>Beep>Binning menu.

6. To start binning

The binning function starts automatically if you are in internal trigger mode.

If you are using the manual triggering mode, press the **Trigger** button or apply a pulse on the trigger pin of the Handler interface to start binning.

See page 38 to set the triggering modes.

7. Display the binning results

There are two different display modes to view results. The Comp (Compare) display mode is the default display mode. This mode will display the currently measured value and displays which of the bins (if any) the measured value is graded as.

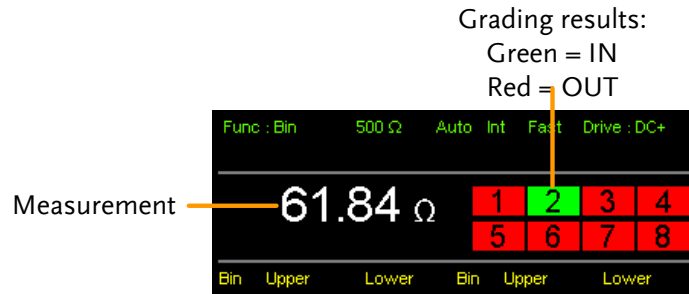

The Count display mode tabulates the results on the right-hand side of the display and shows the bin settings on the left.

Tabulated result of each bin

Bin	Upper	Lower	In	Out	Result
1	062.0000 Ω	061.9000 Ω	641		
2	061.9000 Ω	061.8000 Ω	1289		
3	061.8000 Ω	061.7000 Ω	228		
4	061.7000 Ω	061.6000 Ω	95	Out	793
5	061.6000 Ω	061.5000 Ω	74		
6	061.5000 Ω	061.4000 Ω	42		
7	061.4000 Ω	061.3000 Ω	48	Total	
8	061.3000 Ω	061.0000 Ω	53		3263

Reference : 061.5000 Ω Mode : ABS
 Beep : Off Disp : Count

Meas. Setup System Memory Clear

Overall results (points to the 'Result' column)

Clear results (points to the 'Clear' button)

Upper and lower limits of Bin 1~8 (points to the 'Upper' and 'Lower' columns)

To toggle the display mode, go to the Disp setting and press Enter.

6 061.5000 Ω 061.4000 Ω 42
 7 061.4000 Ω 061.3000 Ω 48 Total
 8 061.3000 Ω 061.0000 Ω 53 3263

Reference : 061.5000 Ω Mode : ABS
 Beep : Off Disp : Count

Meas. Setup System Memory Clear

Move (points to the four directional arrows)

Toggle (points to the Enter key)

Disp setting (points to the 'Disp : Count' setting)

8. How to clear the result count

When in the Count display mode, press the **ESC** key. Go to the Clear setting and press Enter. The accumulated results will be cleared from the display.

Disp : Count

System Memory Clear

Move (points to the left and right arrows)

Clear setting (points to the 'Clear' option)

Clear results (points to the Enter key)

Temperature Measurement

Background The temperature measurement function uses the optional PT-100 temperature probe. The measured temperature is displayed on the display. For more information on the optional PT-100 sensor, see the appendix on page 151.

There is only one range for the temperature function. However the resistance measurement range can still be changed when in the temperature function.

Note: The temperature measurement function is used in conjunction with the Ohm measurement function. The two measurements share the same display, so the Ohm readings stay on the display even after the temperature measurement function is activated. Thus when the Temperature function is selected, “Ohm+T” is shown as the selected function.

1. Select the Temperature function

Press **TEMP** to enter the temperature measurement function.

Temperature + Ohm function indicator

Resistance measurement

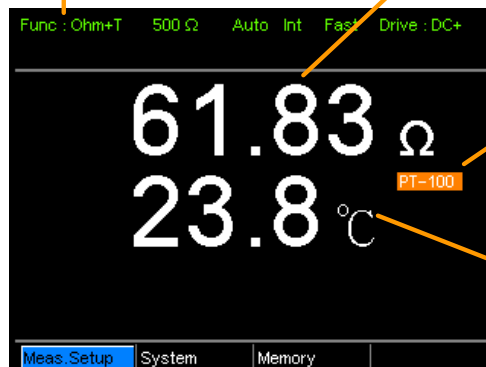

(Ambient) temperature source

Ambient temperature

The temperature is displayed on the Ohm display.

2. Select the temperature units

From the bottom menu, go to Meas. Setup>Temperature Unit and select °C or °F.

See page 65 for setting details.

3. Ambient Temperature

The Ambient temperature setting should be turned off when using the temperature function.

From the bottom menu go to Meas. Setup > Ambient Temperature and turn the Ambient Temperature setting off.

See page 66 for setting details.

4. Temperature mode connection

The temperature sensor uses the rear panel TC Sensor port for input.

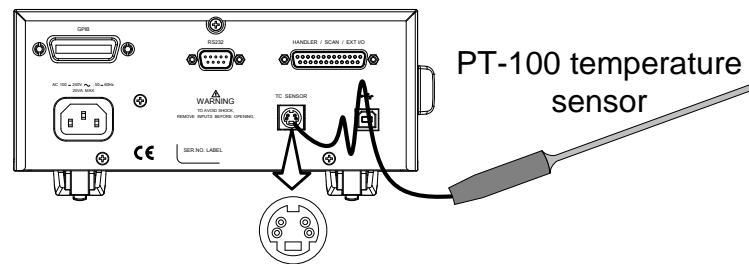

Temperature Compensation

Background

If the resistance of a DUT at a particular temperature is needed, the compensation function can be used. This function can simulate the resistance of a DUT at a desired temperature. If the ambient temperature and the temperature coefficient of the DUT are known, it is possible to determine the resistance of a DUT at any temperature.

The Temperature Compensation works on the following formula:

$$R_{t_0} = \frac{R_t}{1 + \alpha_{t_0}(t - t_0)}$$

Where:

R_t = Measured resistance value (Ω)

R_{t_0} = Corrected resistance value (Ω)

T_0 = Inferred absolute temperature

t_0 = Corrected temperature ($^{\circ}\text{C}$)

t = Current ambient temperature ($^{\circ}\text{C}$)

α_{t_0} = Temperature coefficient of resistance at the correct

temperature. $\alpha_{t_0} = \frac{1}{|T_0| + t_0}$.

1. Select the Temperature Compensation mode

Press **TC** to access the Temperature Compensation function.

The temperature-compensated resistance measurement will appear on the display.

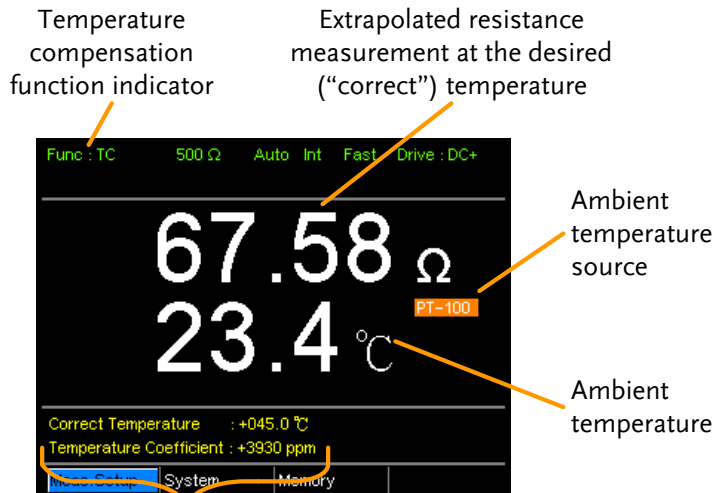

Correct Temperature, Temperature Coefficient settings

2. Ambient Temperature

The ambient temperature can be either measured with the PT-100 sensor or be set manually.

If using the PT-100 sensor the Ambient temperature setting should be turned off. If the PT-100 probe is not used, then the ambient temperature needs to be manually set.

From the bottom menu, go to Meas. Setup > Ambient Temperature and set the ambient temperature.

See page 66 for setting details.

Range Off, -50.0 °C ~ 399.9°C

3. Temperature compensation

Use arrow keys to go to Correct Temperature or to Temperature Coefficient and press Enter to select the setting.

To edit the setting values use the left and right arrow keys to select a digit and use the up and down arrow keys to edit the digit. Press Enter to confirm the setting.

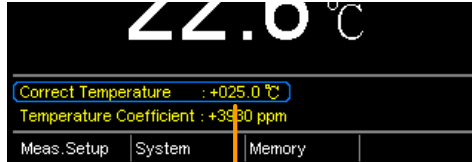
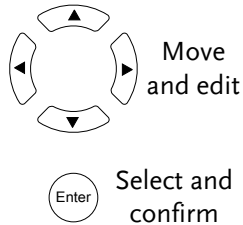

Correct temperature, temperature coefficient settings

Desired Temperature range -50.0 ~ +399.9 °C

Temperature Coefficient range -9999 ~ +9999 ppm

Below are the inferred zero resistance temperatures of some common conductors:

Material	Inferred Absolute Temperatures
Silver	-243
Copper	-234.5
Gold	-274
Aluminium	-236
Tungsten	-204
Nickel	-147
Iron	-162

3. Temperature compensation connection

Sensor Connection:

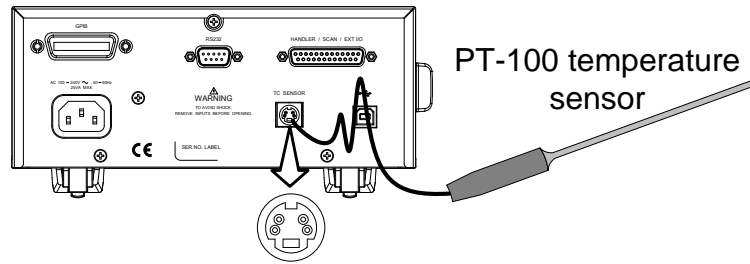

Note: If the sensor is not connected, then the Ambient temperature needs to be manually set.

DUT connection:

4 wire Kelvin:

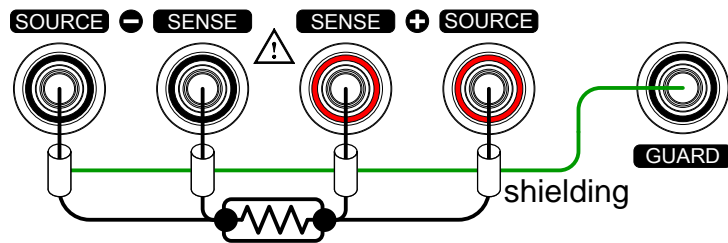

Temperature Conversion

Background

The Temperature Conversion function allows you to determine the temperature change of a DUT at any given resistance, if the initial temperature, the inferred zero resistance temperature for the DUT and the initial resistance of the DUT are known. The displayed result can also be extrapolated to calculate the final temperature (T) or the extrapolated temperature difference (ΔT)*.

Temperature Conversion function works on the following formula:

$$\frac{R_2}{R_1} = \frac{t_0 + t_2}{t_0 + t_1}$$

Where:

R_2 = resistance @ temperature t_2

R_1 = resistance @ temperature t_1

t_0 = inferred zero resistance temperature in °C**

t_1 = temperature at R_1

t_2 = temperature at R_2

The temperature conversion function is can be used to determine the temperature of transformer windings, electric motors, or other materials where it may not be practical to embed a temperature sensor.

$$*(T) \text{ Final temperature} = t_2 = \Delta T + T_A$$

(T_A) Ambient temperature = Ambient temperature when R_2 is measured. T_A can either be manually measured with the PT-100 sensor or it can be manually set.

$$(\Delta T) \text{ Extrapolated temperature difference} = T - T_A$$

**“Constant” setting on the panel display is equivalent to the absolute value of the inferred zero resistance temperature.

Common inferred zero resistance temperatures

Metallic conductors show increased resistivity when temperature is increased, and likewise show reduced resistivity when temperature is reduced. Inferred zero resistance temperature is simply the inferred temperature at which the material will have no resistance. This value is derived from the temperature coefficient of the material. Note: the inferred zero resistance temperature is an ideal value, and not a real-world value.

Material	Inferred zero resistance temp. in °C
Silver	-243
Copper	-234.5
Gold	-274
Aluminium	-236
Tungsten	-204
Nickel	-147
Iron	-162

1. Select the Temperature compensation mode.

Press TCONV to access the temperature compensation function.

The temperature-converted measurement will appear on the display.

Temperature conversion function indicator

Resistance measurement

(Ambient) temperature source

Extrapolated temperature difference or final temperature

Func : TConv 50 mΩ Auto Int Fast Drive : DC+

0.517 mΩ

ΔT : 4.1 °C PT-100

Initial Resistance : 000.5000 mΩ Constant : 180.0

Initial Temperature : +020.0 °C Disp : ΔT

Meas. Setup System Memory

2. Initial Resistance, Initial Temperature and Constant settings

Use the arrows keys to go to Initial Resistance, Initial Temperature or Constant (inferred initial resistance temperature) and press Enter.
 Use the left and right arrow keys to select a digit and use the up and down arrow keys to edit the digit. Press Enter to confirm the edit.

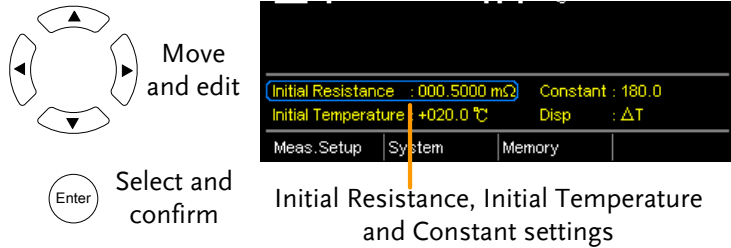

Initial Resistance	000.0001~999.9999 mΩ, Ω, kΩ, MΩ
Initial Temperature	-50.0 ~ +399.9 °C
Constant	000.0~999.9

3. Display mode

Use the arrow keys to go to Disp. Press Enter to toggle between the T and ΔT modes.

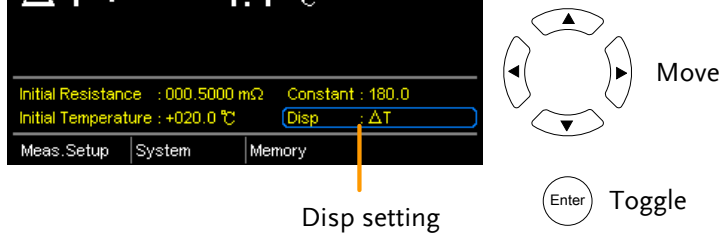

T displays the extrapolated temperature at the measured resistance of the DUT.

ΔT displays the difference from the extrapolated temperature at the measured resistance of the DUT and the ambient temperature. Please refer to page 56 for further details.

3. Temperature compensation connection.

Sensor Connection:

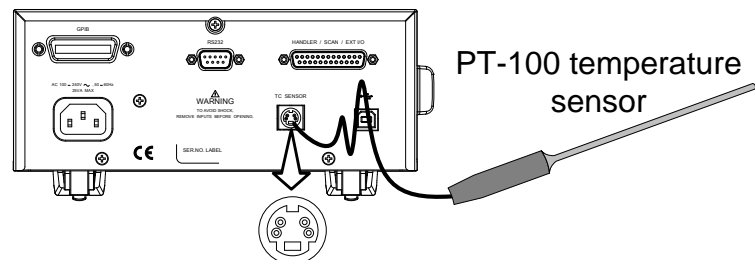

DUT connection

4 wire Kelvin:

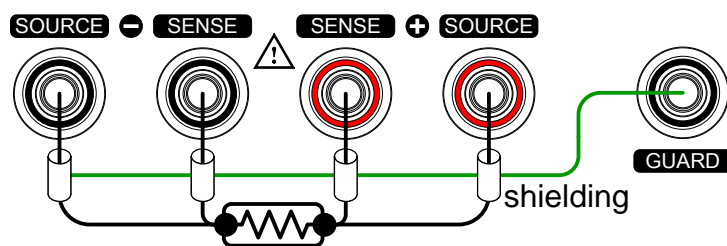

Measurement Settings

Background The following measurement settings are used to configure the various measurement modes.

Average Function

Background The average function smoothes measurements using a moving average. The average function sets the number of samples used for the moving average; a higher number results in smoother measurement results. The average function is turned off by default.

1. Select Average setting From one of the main screens, press the **ESC** key so that the menu system at the bottom of the display has focus.

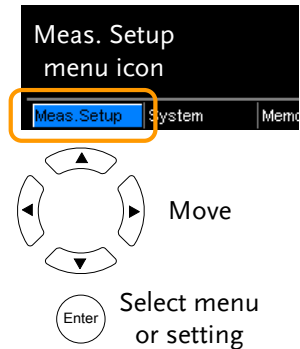

Go to Meas. Setup and press Enter.
Go to Average and press Enter.

2. Average setting appears Use the arrow keys to turn Average on and set the average number. Press Enter to confirm the setting.

Average settings

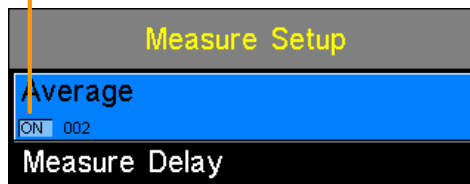

Average OFF, ON: 2~100



Note

Pressing ESC before pressing ENTER will exit the Average function settings.

Measure Delay

Background

The Measure Delay setting inserts a delay time between each measurement. Measure delay is turned off by default.

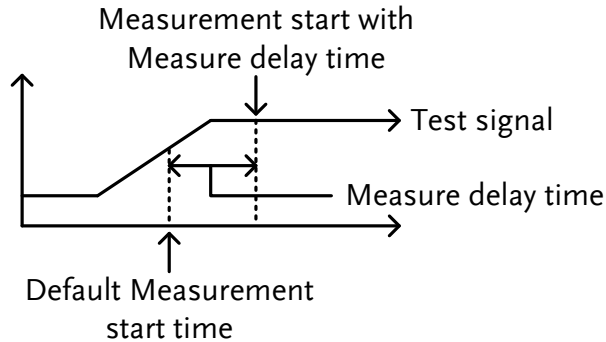

The measure delay setting is useful for measuring components that need some time to charge if the default measurement start time is not adequate. An adequate delay time allows the meter to avoid the effects of transient disturbances that are usually seen when measuring reactive DUTs with a current source.

1. Select Measure Delay setting

From one of the main screens, press the **ESC** key so that the menu system at the bottom of the display has focus.



Go to Meas. Setup and press Enter.

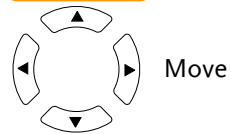

Go to Measure Delay and press Enter.

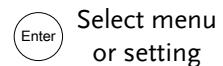

2. Measure Delay setting appears

Use the arrow keys to turn Measure Delay on and set the delay time. Press Enter to confirm the setting.

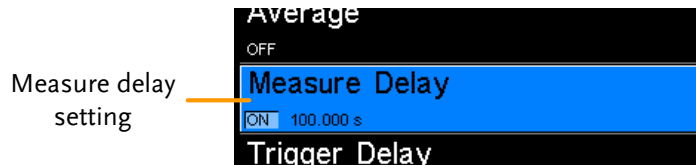

Measure Delay* OFF, ON: 000.000 ~ 100.000s

* When the set value is > 0.1s, the resolution is 0.1s.
When the set value is < 0.1S, the resolution is 1mS.



Note

Pressing ESC before pressing ENTER will exit the Measure Delay settings.

Trigger Delay

Background

The Trigger Delay setting adds a delay to when an external trigger signal is recognized. Normally the external trigger is recognized when there is no contact bounce in the signal for a fixed length of time, this time is known as the bounce monitoring window. This ensures that the external trigger signal is stable before it is recognized. The Trigger Delay time starts right after the bounce monitoring window ends.

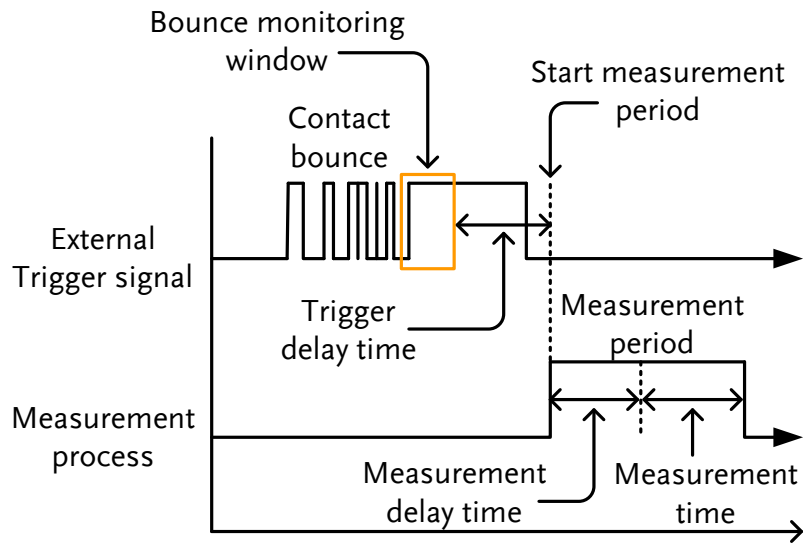

The Trigger Delay setting is turned off by default.



Note

Pin 2 of the Handler/Scan/Ext I/O interface is used for external triggering, See page 77 for pinout details.

1. Select Trigger Delay setting

From one of the main screens, press the **ESC** key so that the menu system at the bottom of the display has focus.

Go to Meas. Setup and press Enter.

Go to Trigger Delay and press Enter.

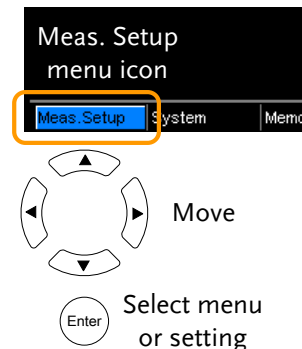

2. Trigger Delay setting appears Use the arrow keys to turn Trigger Delay on and set the delay time. Press Enter to confirm the settings.

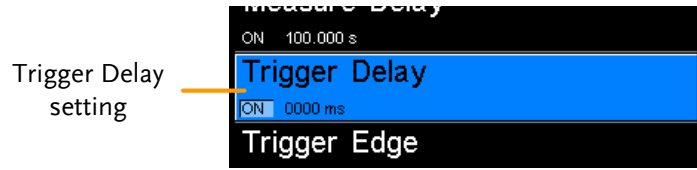

Trigger Delay OFF, ON: 0 ~ 1000ms



Note

Pressing ESC before pressing ENTER will exit the Trigger Delay settings.

Trigger Edge

Background The Trigger Edge setting sets the external trigger edge as rising or falling. By default the trigger edge is set to rising.

1. Select Trigger Edge setting From one of the main screens, press the **ESC** key so that the menu system at the bottom of the display has focus.

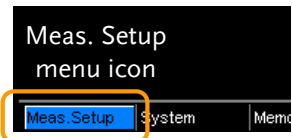

Go to Meas. Setup and press Enter.
Go to Trigger Edge and press Enter.

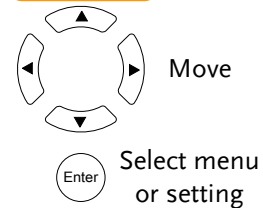

2. Trigger Edge setting appears Use the arrow keys to set the Trigger Edge. Press Enter to confirm the setting.



Trigger Edge Rising, Falling



Note

Pressing ESC before pressing ENTER will exit the Trigger Edge settings.

Temperature Unit

Background Temperature units can be set to Fahrenheit or Celsius for all temperature measurements.

1. Select Temperature Unit setting From one of the main screens, press the **ESC** key so that the menu system at the bottom of the display has focus.

Go to Meas. Setup and press Enter.

Go to Temperature Unit and press Enter.

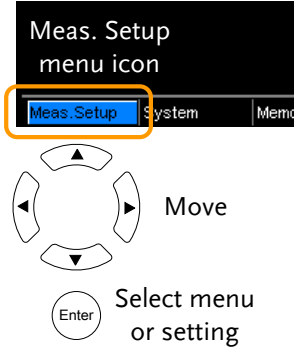

2. Temperature Unit setting appears Use the arrow keys to set the Temperature Unit. Press Enter to confirm the setting.

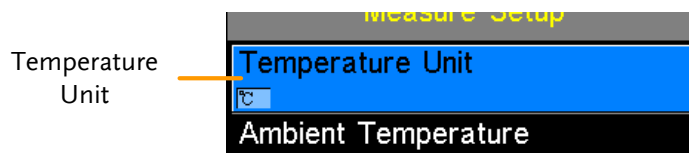

Temperature Unit Fahrenheit, Celsius



Note

Pressing ESC before pressing ENTER will exit the Temperature Unit setting.

Ambient Temperature

Background The Ambient Temperature setting is used to set the ambient (room temperature) for the Temperature Compensation or Temperature Conversion function in the absence of the PT-100 temperature sensor. See page 52 and 56 respectively for details.

1. Select Ambient Temperature setting From one of the main screens, press the **ESC** key so that the menu system at the bottom of the display has focus.



Go to Meas. Setup and press Enter.
Go to Ambient Temperature and press Enter.

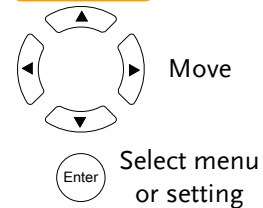

2. Ambient Temperature setting appears

Use the arrow keys to set the Ambient Temperature. Press Enter to confirm the setting.

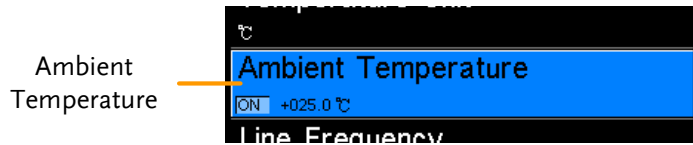

Ambient Temperature Off, On: -50°C ~ 399.9°C



Note

Pressing ESC before pressing ENTER will exit the Ambient Temperature setting.

Line Frequency

Background The Line Frequency setting selects the appropriate line filter to reduce the influence of the AC line frequency on the milliohm measurements. This setting is set to AUTO by default.

1. Select Line Frequency setting

From one of the main screens, press the **ESC** key so that the menu system at the bottom of the display has focus.

Go to Meas. Setup and press Enter.

Go to Line Frequency and press Enter.

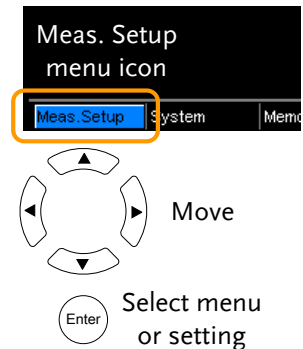

2. Line Frequency setting appears Use the arrow keys to set the Line Frequency. Press Enter to confirm the setting.



Line Frequency Auto, 50Hz, 60Hz



Note

Pressing ESC before pressing ENTER will exit the Line Frequency setting.

PWM Setting

Background

The PWM setting will set the duty of the PWM Drive setting. The duty is set with ON and OFF times for the waveform.

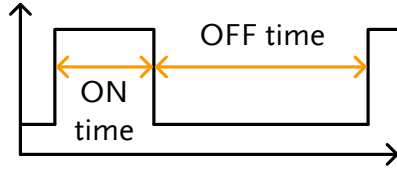

See page 31 for Drive setting details.

1. Select PWM setting

From one of the main screens, press the **ESC** key so that the menu system at the bottom of the display has focus.



Go to Meas. Setup and press Enter.
Go to PWM and press Enter.

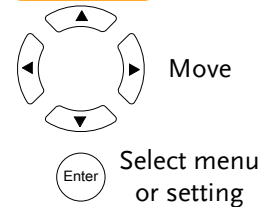

2. PWM setting appears

Use the arrow keys to set the ON and OFF time for the duty. Press Enter to confirm the setting.



ON	03 ~ 99 time units*
OFF	0100 ~ 9999 ms

*The ON time setting is set in “time units”, not milliseconds. The amount of time in a time unit depends on the line frequency settings (see page 67).

Line frequency	1 Time Unit
60Hz	16.6mS
50Hz	20mS



Note

Pressing ESC before pressing ENTER will exit the PWM setting.

System Settings

Background The System settings are used to view the system information, set the power on state, the remote interface, screen brightness, external interface and beep settings as well as access the calibration menu.

System Information

Background The System Information will show the manufacturer, model, software version and serial number of the unit. The system information is the equivalent of the return string from the *idn? query (page 137).

1. View System Information

From one of the main screens, press the **ESC** key so that the menu system at the bottom of the display has focus.

Go to System and press Enter.

System information will be displayed at the top of the System menu.

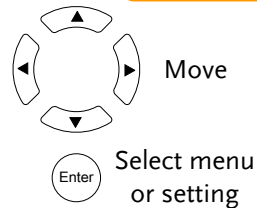
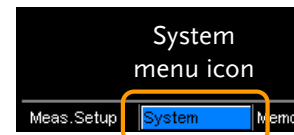

System Information of hardware with the old PCB board

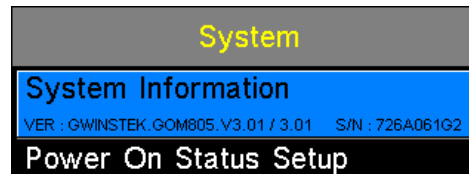

System Information of hardware with the latest PCB board

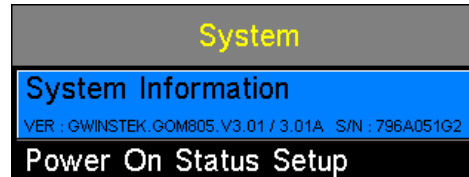

Note: From the screenshot above where “A” from the 3.01A indicates it is equipped with the latest PCB board, which empowers the features of HVP and Standby mode. Refer to page 77 for details of HVP and page 31 for details of Standby mode.



Pressing ESC will exit from the System menu.

Power On Status Setup

Background The Power On Status Setup allows you to either load the previous settings or the default settings on startup.

1. Select Power On Status setting

From one of the main screens, press the **ESC** key so that the menu system at the bottom of the display has focus.

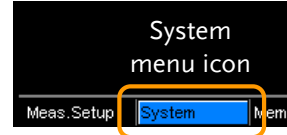

Go to System and press Enter.

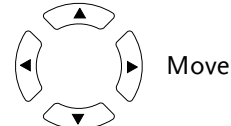

Go to Power On Status Setup and press Enter.

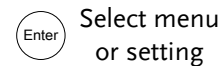

2. Power On Status Setup appears

Use the arrow keys to set Power ON Status Setup. Press Enter to confirm the setting.

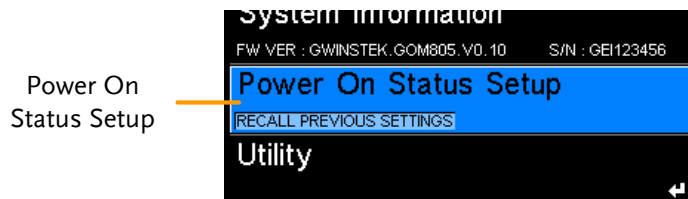

Power On Status Recall Previous Settings, Load Default



Note

Pressing ESC before pressing ENTER will exit the Power On Status Setup.

Interface

Background The remote interface can be set to RS232, GPIB or USB.



Note

The GPIB interface is only available on the GOM-804G and the GOM-805.

1. Select Interface setting

From one of the main screens, press the **ESC** key so that the menu system at the bottom of the display has focus.

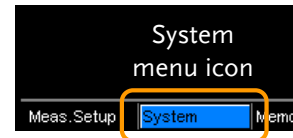

Go to System and press Enter.

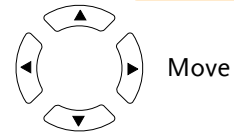

Go to Utility and press Enter.

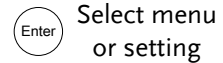

Go to Interface and press Enter.

2. Interface setting appears

Use the arrow keys to choose an interface and to set the baud rate (RS232) or primary address (GPIB). The EOL (end of line) character can also be set. Press Enter to confirm the settings.



Interface	GPIB, Primary Address (1 ~ 30)
	RS232, Baud Rate (1200, 2400, 4800, 9600, 19200, 38400, 57600, 115200)
	USB
DATA OUT	ON, OFF
EOL	LF, CR, CR+LF, LF+CR (default = LF) See page 105 for further details.



Note

- Pressing ESC before pressing ENTER will exit from the Interface settings.
- After DATA OUT is turned on, the measured value will be automatically sent back, via communicating interface, to the connected PC.
- The DATA OUT function is only available when Trigger Mode is selected in EXT.

Brightness

Background The Brightness setting sets the backlight brightness of the TFT-LCD panel.

1. Select Brightness setting

From one of the main screens, press the **ESC** key so that the menu system at the bottom of the display has focus.

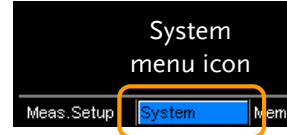

Go to System and press Enter.

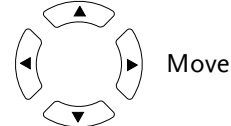

Go to Utility and press Enter.

Go to Brightness and press Enter.

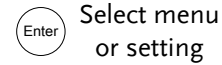

2. Brightness setting appears

Use the arrow keys to set the brightness level. Press Enter to confirm the setting.

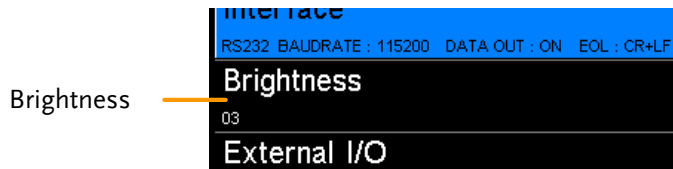

Brightness 01 (dim) ~ 05 (bright)



Note

Pressing ESC before pressing ENTER will exit from the Brightness settings.

User Define Pins

Background The External I/O User Define Pin settings set the logic and the active level for the Define 1 and Define 2 pins on the Handler/Scan/EXT I/O port on the rear panel. The External I/O pins are used with the compare or bin functions. The logic settings can be based on the pass, fail, high, low or bin grade results of the selected function.

- 1. Select External I/O Setting** From one of the main screens, press the **ESC** key so that the menu system at the bottom of the display has focus.

Go to System and press Enter.

Go to Utility and press Enter.

Go to External I/O and press Enter.

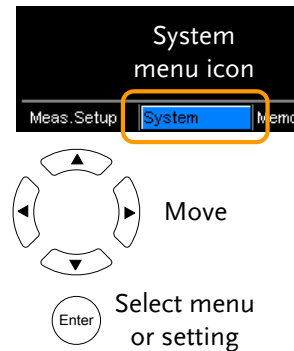

- 2. External I/O Menu Appears** Use the arrow keys to choose either User Define 1 or User Define 2 and press Enter.

Use the arrow keys to set the active level of the pin when the logic conditions are true and to set the logic settings. Press Enter to confirm the settings.

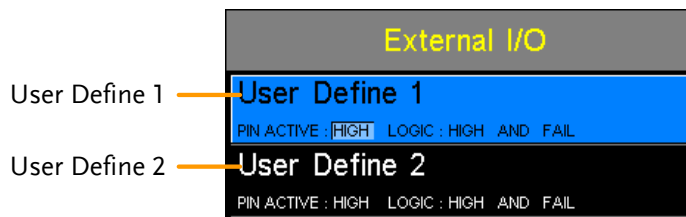

User Define 1/2: Pin Active: High, Low

Logic:

Operand1	Operator	Operand2
Fail		Fail
Pass	Logical OR,	Pass
Low	Logical	Low
High	AND,	High
Bin O**	OFF*	Bin O**
Bin 1 ~ 8		Bin 1 ~ 8

*The OFF operator sets the Logic as true when Operand1 is true.

** Bin 0 is defined as outside bin 1~ 8.



Note

The Bin logic settings are not available for the GOM-804.

Pressing ESC before pressing ENTER will exit from the selected External I/O setting.

Handler Mode

Background

The Handler Mode setting determines the behavior of the result signals from the handler interface. There are two settings, Clear and Hold. The Clear setting will clear the results of the previous test before starting the succeeding one and the Hold setting will keep the test result of the previous test until the succeeding test has completed.

The timing diagrams below are used as examples. All the result signals in the examples are active high.

Clear example

Clear: All result signals (PASS, Fail, High and Low) are cleared at the falling edge of EOT and the results from the current test are output at the rising edge of the EOT signal.

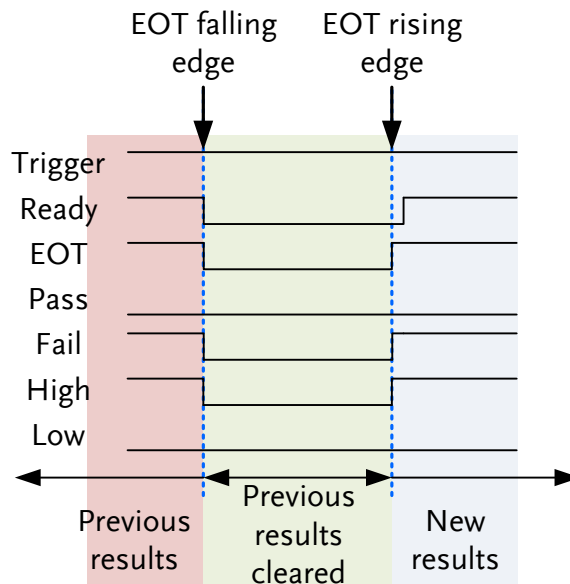

Hold example

Hold: The results of the previous tests are held until the current test has completed.

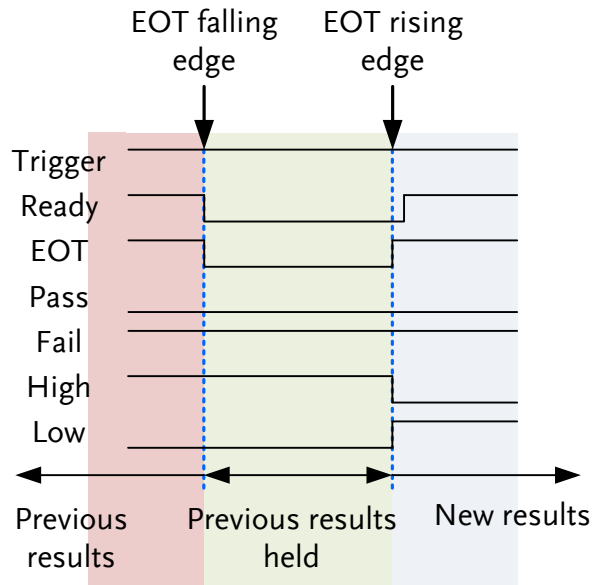

1. Select External I/O setting

From one of the main screens, press the **ESC** key so that the menu system at the bottom of the display has focus.

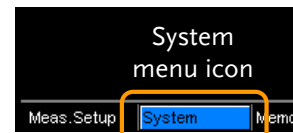

Go to System and press Enter.
 Go to Utility and press Enter.
 Go to External I/O and press Enter.

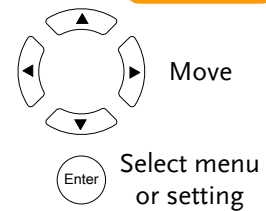

2. External I/O menu appears

Use the arrow keys to choose Handler Mode and press Enter.

Use the arrow keys to set the handler mode. Press Enter to confirm the setting.

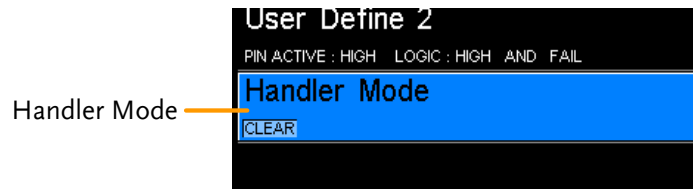

Handler Mode HOLD, CLEAR

 Note

Pressing ESC before pressing ENTER will exit from the Handler Mode setting.

Beep

Background

The Beep setting will configure the beeper sound for the key presses, the Compare function and the Binning function.

For the Compare and Binning function the beep can be configured to beep on a pass or fail judgment.

1. Select Beep setting

From one of the main screens, press the **ESC** key so that the menu system at the bottom of the display has focus.

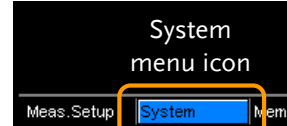

- Go to System and press Enter.
- Go to Utility and press Enter.
- Go to Beep and press Enter.

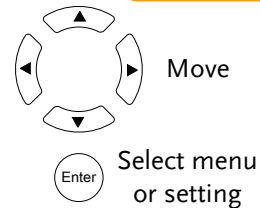

2. Beep menu appears

Use the arrow keys to choose a beep setting and press Enter.

Use the arrow keys to set the selected setting and press Enter to confirm.

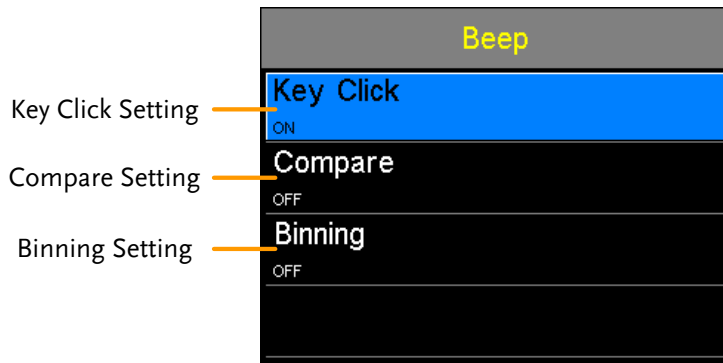

Beep Settings:	Key Click	On, Off
	Compare	Off. Pass, Fail
	Binning	Off. Pass, Fail



Note

Pressing ESC before pressing ENTER will exit from the selected Beep setting.

High Voltage Protect

Background This page is to enable or disable the function of HVP (High Voltage Protect), which promptly interrupts output to DUT with warning note present when high voltage is carried by the DUT. If, on the other hand, HVP is tuned Off, output test will keep going without interruption in any case.



Note

The HVP function is enabled by default and can be deactivated by user manually. When HVP is disabled, user need to, however, particularly pay attention to if any high voltage occurs from the connected DUT, which may cause devastated result on GOM series.

1. Select High Voltage Protect setting

From one of the main screens, press the **ESC** key so that the menu system at the bottom of the display has focus.

Go to System and press Enter.

Go to Utility and press Enter.

Go to High Voltage Protect and press Enter.

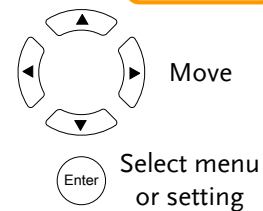
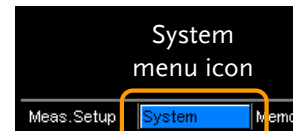

2. High Voltage Protect menu appears

Use the up and down arrow keys to change the High Voltage Protect setting followed by pressing the Enter button to confirm and take effect.

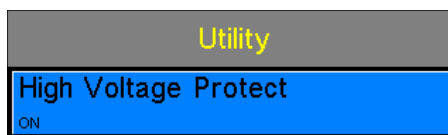

High Voltage Protect Setting: On, Off

When high voltage is detected from DUT, the warning message will prompt as the screenshot shown and will disappear only after the high voltage withdraws.

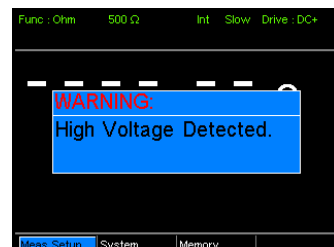

Note

- HVP is turned ON by default and reboot will restore the unit back to the factory default setting.
- Pressing ESC before pressing ENTER will exit from the High Voltage Protect setting.

HANDLER/SCAN

INTERFACE

Handler	Handler Overview	79
	Pin Definitions for the Handler Interface.....	81
	Handler Interface for Binning and Compare Functions	81
<hr/>		
Scan	Scan Overview	83
	Pin Definitions for the SCAN Interface	84
	Scan Interface	84
	Scan Setup	85
	Scan Output.....	89
<hr/>		
GOM-802 Compatibility	GOM-802 Compatibility for Scan and Handler Interfaces	90
	GOM-805 to GOM-802 Handler/Scan Interface.....	90
<hr/>		
Remote Interface	Configure USB Interface	91
	Install USB Driver	92
	Configure RS-232 Interface	93
	Configure GPIB Interface	94
	RS232/USB Function Check	94
	Using Realterm to Establish a Remote Connection	95
	GPIB Function.....	97

Handler Overview

Background The Handler interface is used to help grade components based on the Compare or Binning function test results. The appropriate pins on the handler interface are active when the Compare or Binning function is used.

There are 17 TTL outputs and 1 TTL inputs. The Handler interface is only applicable with the Binning function or Compare measurement modes.



Note

Please see following pages for related functions and settings:

Compare function: 41

Binning function: 45

Ext I/O settings: 73

Handler mode settings 74

Interface and pin assignment

25-Pin D-SUB
(Female)

HANDLER / SCAN / EXT I/O

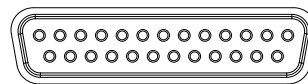

Pin assignment

TRIGGER

Starts the trigger for a single measurement.

READY

High when the measurement has finished. The instrument is ready for the next trigger.

EOT

High when the AD conversion has completed. The DUT is ready to be changed.

BIN 1~8

High when the sorting result is in one of the eight bin grades. Bin1~8 (pass).

BIN OUT

High when the sorting result is out of all the eight bin grades (Bin1~8). The status of this pin reflects either a HI or LO result (fail).

LOW

High when the compare result is deemed LO.

HIGH

High when the compare result is deemed HI.

FAIL	High when the compare result is either HI or LO (fail).
PASS	High when the compare result is IN (pass).

For the full pin definition, please refer to the table listed below.



Note

The output current from all the pins and the VINT(+5V) pin cannot exceed 60mA.

Pin Definitions for the Handler Interface

As this interface is used for the handler and scan functions, the interface pinout depends on the function mode. The following pinout is only applicable when using the Binning or Compare function.

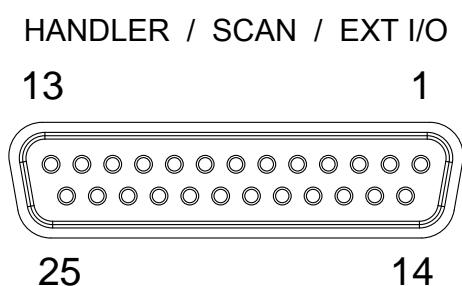

Handler Interface for Binning and Compare Functions

Pin	Name	Description	Active modes	In/Out
1, 17		Reserved		
2	Trigger	Trigger for a single measurement.	All	In
3, 14, 18	GND	Ground.		
4	Fail	High when the compare result is either HI or LO (fail).	Compare	Out
5	High	High when the compare result is deemed HI.	Compare	Out
6	Pass	High when the compare result is IN (pass).	Compare	Out
7	EOT	High when the AD conversion has completed. The DUT is ready to be changed.	Ext trigger mode	Out
8	VINT	Internal DC Voltage +5V.		Out
9	Bin1	High when the binning sorting result is within the bin1 setting range.	Binning	Out
10	Bin2	High when the binning sorting result is within the bin2 setting range.	Binning	Out
11	Bin3	High when the binning sorting result is within the bin3 setting range.	Binning	Out
12	Bin4	High when the binning sorting result is within the bin4 setting range.	Binning	Out

13	Bin5	High when the binning sorting result is within the bin5 setting range.	Binning	Out
15	Userdefine2	High or low when the user define2 logic conditions are met.	Compare, Binning	Out
16	Userdefine1	High or low when the user define1 logic conditions are met.	Compare, Binning	Out
19	VEXT	External DC Voltage, acceptable range is +5V.		In
20	Ready	High when the measurement has finished. The instrument is ready for the next trigger.	Ext trigger mode	Out
21	Bin6	High when the binning sorting result is within the bin6 setting range.	Binning	Out
22	Low	High when the compare result is deemed LO.	Compare	Out
23	Bin7	High when the binning sorting result is within the bin7 setting range.	Binning	Out
24	Bin8	High when the binning sorting result is within the bin8 setting range.	Binning	Out
25	Bin Out	High when the binning sorting result is out of all the bin setting ranges.	Binning	Out

For backwards compatibility with the GOM-802 handler interface, please see page 90.

Scan Overview

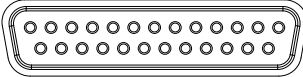
Background	<p>The Scan function is used to automatically bin groups of up to 100 components. The associated pins in the handler interface are active when the Scan function is activated.</p> <p>There are a total of 6 outputs, 3 inputs as well as a GND and power (+5V) pin.</p>	
Interface and pin assignment	25Pin D-SHELL (Female)	<p>HANDLER / SCAN / EXT I/O</p> 
Pin Assignment	Relay	Controls the relay output.
	Pass	Pass signal. Indicates the compare result is IN(pass).
	Low	Low signal. Indicates a LO compare result.
	High	High signal. Indicates a HI compare result.
	Clock	The clock signal will pulse high when each group of output signals (Relay, Pass, Low, High) are ready. There are up to 100 groups of output signals
	STRB	After all (100) output groups are ready, the STRB signal will pulse high.

Pin Definitions for the SCAN Interface

As this interface is used for the handler and scan functions, the interface pinout depends on the function mode. The following pinout is only applicable when using the Scan function.

HANDLER / SCAN / EXT I/O

13

1

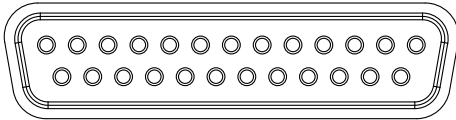

25

14

Scan Interface

Pin	Name	Description	In/Out
1,9-13,15-17,21,23-25		Reserved	
2	Trigger	Start for Scan measurement.	In
3,14,18	GND	Ground.	
4	High	High signal. Indicates a HI compare result.	Out
5	Clock	The clock signal will pulse high when each group of output signals (Relay, Pass, Low, High) are ready. There are up to 100 groups of output signals.	Out
6	Low	Low signal. Indicates a LO compare result.	Out
7	Pass	Pass signal. Indicates an IN compare result (pass).	Out
8	VINT	Internal DC Voltage +5V.	Out
19	VEXT	External DC Voltage, acceptable range is +5V.	In
20	Relay	Controls the relay output.	Out
22	STRB	After all (up to 100) output groups are ready, the STRB signal will pulse high.	Out

For backwards compatibility with the GOM-802 scanner interface, please see page 90.

Scan Setup

Background

The Scan function sequentially scans up to 100 channels and grades the resistance of the DUT on each channel to a reference value. An automated handler or test fixture is required to interface the DUTs to the measurement terminals and the scan interface that controls the timing of each scan.

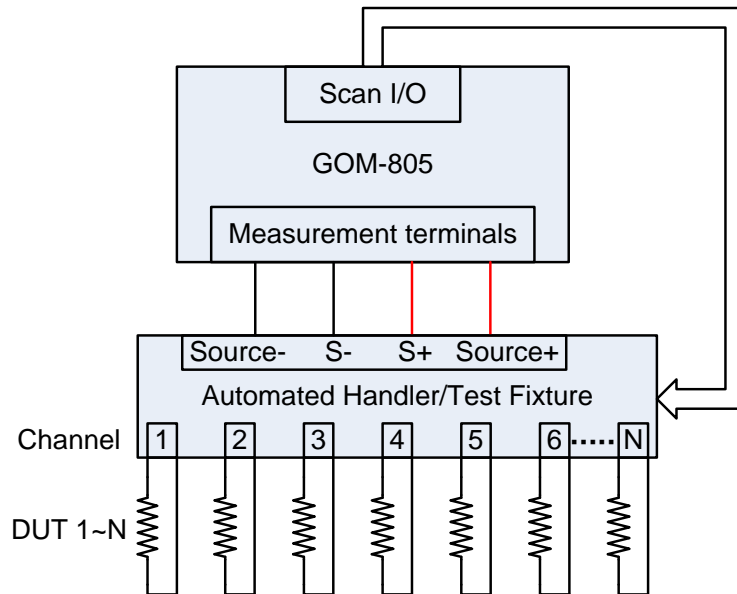

Note: The automated handler/test fixture is user-supplied. Please see your distributor for support and technical details.

Grading of each DUT is essentially the same as the compare function (page 41), the difference being the Scan function will compare up to 100 DUTs sequentially, whereas the Compare function will compare only one DUT at a time.

The scan function compares a measured value to a “Reference” value that has an upper (HI) and lower (LO) limit. If the measured value is within the upper and lower limit, then the measured value is judged as IN.

There are two modes that can be used to make a judgment: ABS and $\Delta\%$ modes.

The ABS mode compares the measured value to the upper (HI) and lower (LO) limits. The upper and lower limits are set as absolute resistance values.

The $\Delta\%$ compare function compares the deviation of the measured value from the reference value as a percentage.

$$\{ [(Measured\ Value - Reference) / Reference] \% \}$$

A measured value that falls within the upper and lower limits is considered IN (pass), a value that falls below the lower limits is considered LO, and a value that falls over the upper limit is a HI.

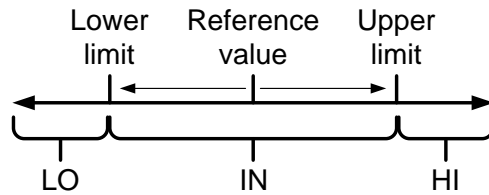

For both scan modes, the IN, HI or LO will be shown on the display for each judgment (if the time between each judgment is not too fast).

Display Overview

1. Select the Scan function

Press Scan to access the scan mode, as shown above.

2. Select the compare mode

Use the arrow keys to navigate to the Mode setting. Press the Enter key to toggle the compare mode.

Range Abs, Δ %

3. Channel setting

The Channel setting sets the number of DUT channels that are used.

Use the arrow keys to navigate to the Channel setting and press Enter.

Use the left and right arrow keys to select a digit. Use the up and down arrow keys to edit the value of the selected digit. Press Enter to confirm the setting.

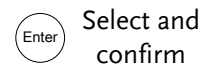
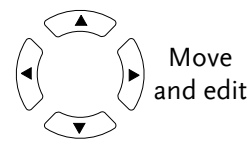
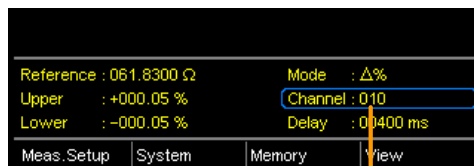

Channel setting

Channel Range: 01 ~100

4. Delay setting

The Delay setting adds a pause between each channel measurement.

The Use the arrow keys to navigate to the Delay setting and press Enter.

Use the left and right arrow keys to select a digit. Use the up and down arrow keys to edit the value of the selected digit. Press Enter to confirm the setting.

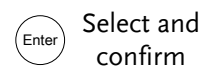
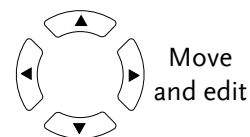
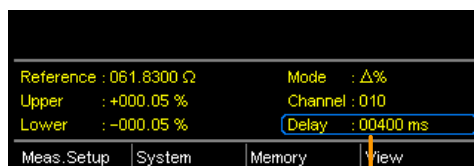

Delay setting

Delay Range: 400ms ~ 30000ms

5. Start the scan.

Press the **Trigger** key or input a pulse signal on the Trigger pin of the SCAN interface port to start a scan test.



Note

See page 64 to set the external trigger edge as a rising or falling leading edge.

The results will be displayed on the screen as each test is performed. The results will also be output through the scan port until the scan has finished.

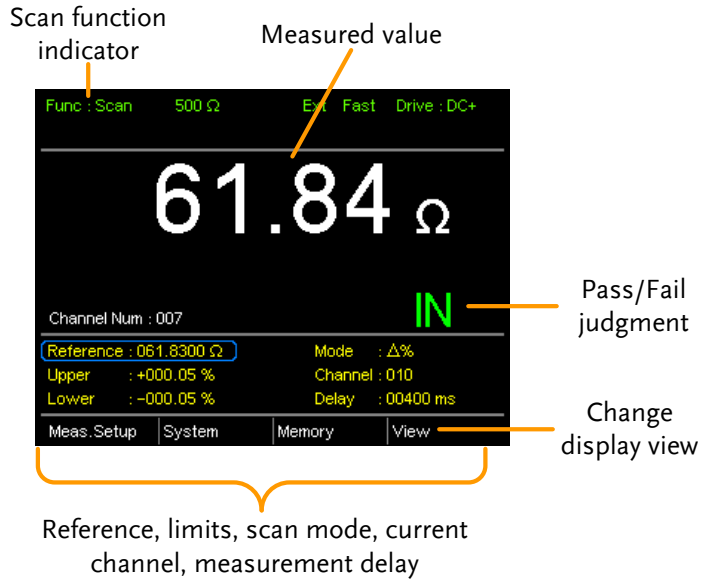

6. View Results

After the last SCAN test has finished, press the **ESC** key so that the menu system at the bottom of the display has focus. Go to View and press Enter to view the results of each channel.

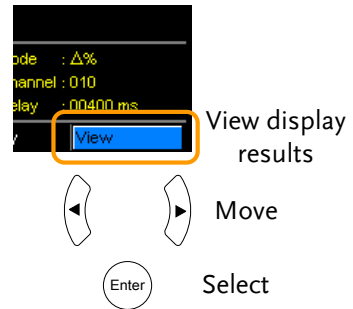

Use the Previous and Next soft-keys to view each page. Use the Back soft-key to return to the previous window.

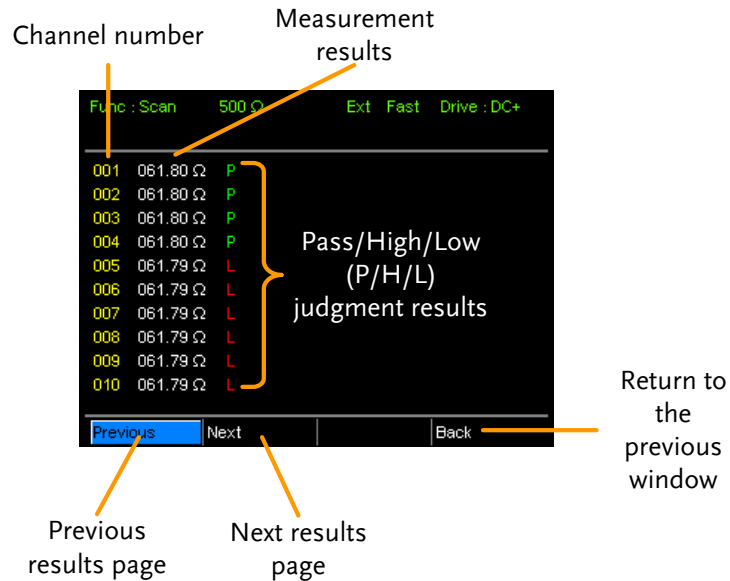

Scan Output

Background The timing diagrams for the scan output under different conditions are shown below.

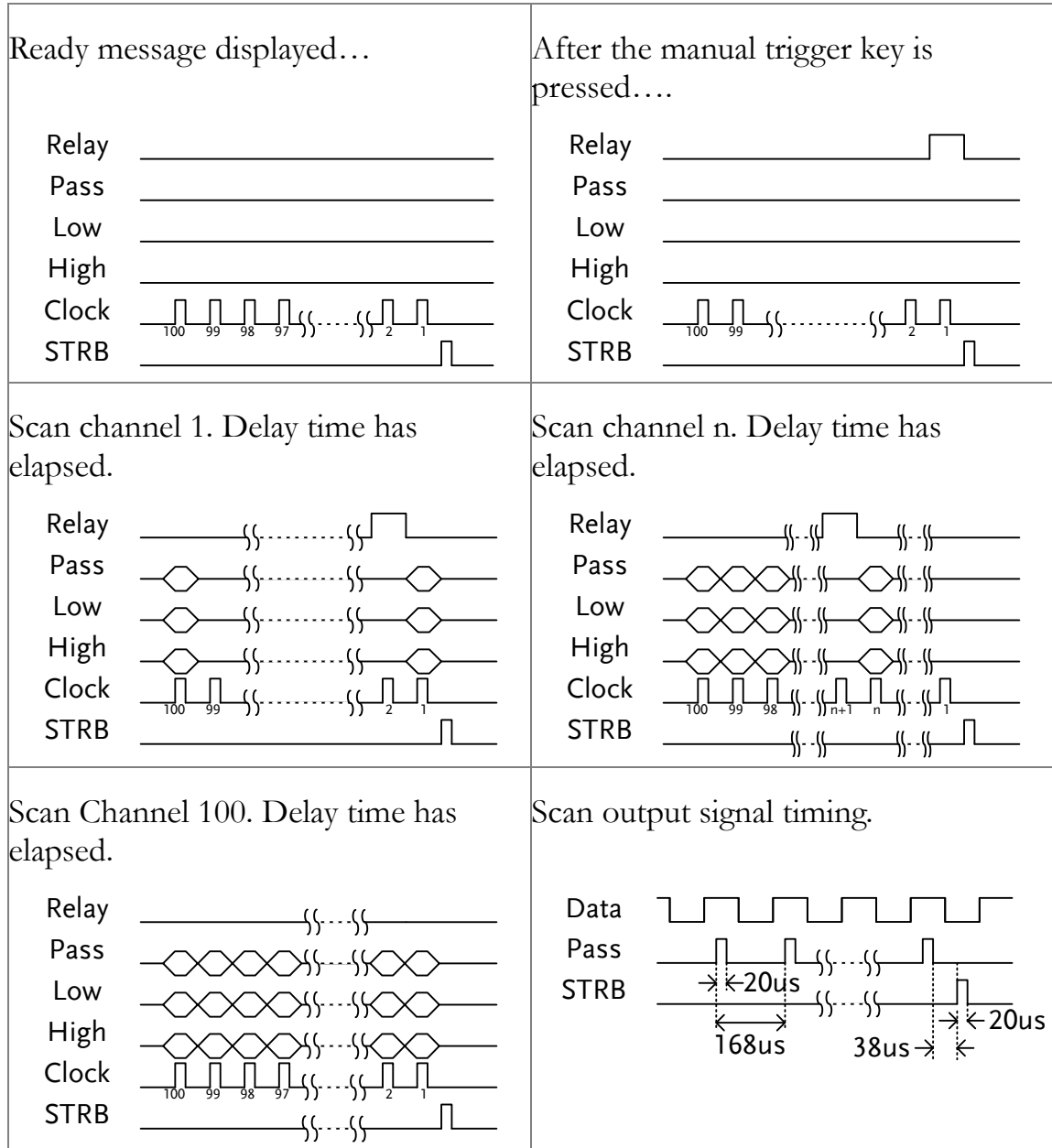

GOM-802 Compatibility for Scan and Handler Interfaces

As the handler interface on GOM-802 is a 9-pin D-sub and the GOM-805 is a 25-pin D-sub, the GOM-805 handler interface cannot be used with existing GOM-802 ATE equipment or environments without modification.

For backwards compatibility with the GOM-802 handler interface, please refer to the chart below:

GOM-805 to GOM-802 Handler/Scan Interface

GOM-805 Handler Interface			GOM-802 Handler Interface			
Pin	Handler	Scan		Pin	Handler	Scan
1, 17	Reserved	Reserved				
2	Trigger	Trigger	→	3	Start	NC
3, 14, 18	GND	GND	→	2	GND	GND
4	Fail	High	→	7	Fail	High
5	High	Clock	→	8	High	Clock
6	Pass	Low	→	6	Pass	Low
7	EOT	Pass	→	5	EOT	Pass
8	VINT	+5V	→	1	+5V	+5V
9	Bin1					
10	Bin2					
11	Bin3					
12	Bin4					
13	Bin5					
15	Userdefine2					
16	Userdefine1					
19	VEXT	VEXT				
20	Ready	Relay	→	4	Ready	Relay
21	Bin6					
22	Low	STRB	→	9	Low	STRB
23	Bin7					
24	Bin8					
25	Bin Out					

Configure Interface

Overview The RS-232 and USB interfaces are standard for all models, however the GPIB interface is only applicable for the GOM-804G and GOM-805. The remote control interfaces allow the GOM-804/805 to be programmed for automatic testing.

For more information on remote control programming, please see the Command Overview chapter on page 103.

Interface	USB	USB Device
	RS-232	DB-9 male port
	GPIB	24 pin female GPIB port (GOM-804G, GOM-805 only)

Configure USB Interface

Background The Type B USB port on the rear panel is used for remote control. This interface creates a virtual COM port when connected to a PC.



Note

The USB interface requires the USB driver to be installed. See page 92 to install the USB driver.

1. Connect and configure to USB.

Configure the interface to USB in System>Utility>Interface menu.

Page 71

Connect the Type A-B USB cable to the rear panel USB B port on the GOM-804/805.

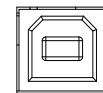

Connect the other end to the Type A port on the PC.

Install USB Driver

Background	The USB driver needs to be installed when using the USB port for remote control. The USB interface creates a virtual COM port when connected to a PC.
------------	---

1. Select the USB driver.	Configure the interface to USB in System>Utility>Interface menu.	Page 71
---------------------------	--	---------

Connect the Type A-B USB cable to the rear panel USB B port on the GOM-804/805. Connect the other end to the Type A port on the PC.



Go to the Windows Device Manager.
 For Windows 7 go to:
 Start Menu > Control Panel > Hardware and Sound > Device Manager

The GOM-804/805 will appear as an unknown Virtual Com Port under “Other Devices”.

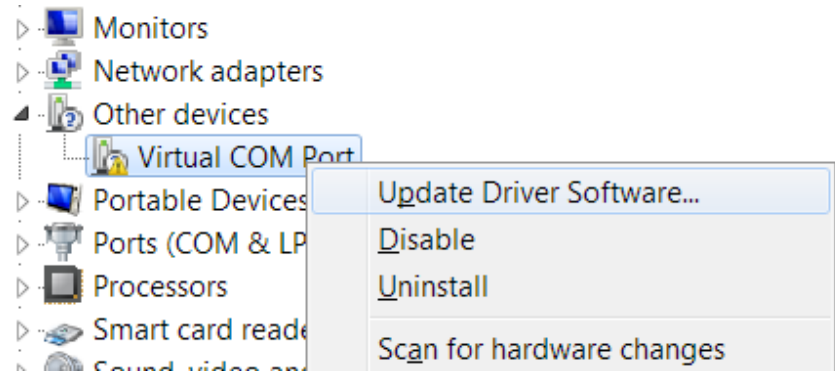

Right-click Other Devices and select “Update Driver Software”.

Select “Browse my computer for driver software” and select the driver on the User Manual CD.

The GOM-805 and the COM port that it is assigned to will now appear in under the Ports (COM & LPT) node.

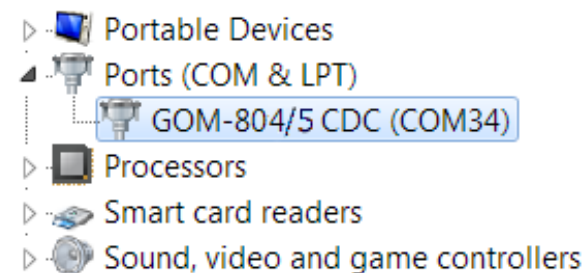

Configure RS-232 Interface

Background The GOM-804/805 can also use an RS-232C connection for remote control. When connecting to a PC ensure the correct baud rate, parity, data bits, stop bit and data control settings are used.

Settings	Baud rate	1200, 2400, 4800, 9600, 19200, 38400, 57600, 115200
	Parity	None
	Data bits	8
	Stop bit	1
	Data flow control	None

1. Select the RS-232 baud rate Configure the interface to RS232 and set the baud rate in System>Utility>Interface menu. Page 71

Connect the RS-232C cable to the rear panel RS232 port.

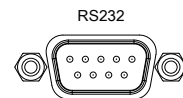

RS-232 pin assignment

Pin 2: RxD
 Pin 3: TxD
 Pin 5: GND
 Pin 1, 4, 6 ~ 9: No Connection

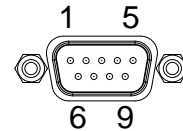

PC – GOM RS-232C connection The RS232C connection uses a Null-modem connection, in which transmit (TxD) and receive (RxD) lines are cross-linked.

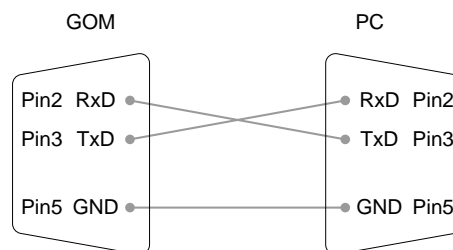

Configure GPIB Interface

Background The GPIB interface is SCPI-1994, IEEE488.1 and IEEE488.2 compliant.



Note

The GPIB interface is only available on the GOM-804G and GOM-805.

1. Select the GPIB address

Configure the interface to GPIB and set Page 71 the GPIB address in System>Utility>Interface menu.

Connect one end of the GPIB cable to the computer and the other end to the GPIB port on the GOM-805.



RS232/USB Function Check

Operation

Invoke a terminal application such as Realterm.

For RS-232, set the COM port, baud rate, stop bit, data bit and parity accordingly.

To check the COM settings in Windows, see the Device Manager. For example, in WinXP go to the Control panel → System → Hardware tab.

Run this query from the terminal.

```
*idn?
```

This should return the Manufacturer, Model number, and Firmware version.

```
GWINSTEK,GOM805,GXXXXXXXXX,V1.00
```



Note

If you are not familiar with using a terminal application to send/receive remote commands from the serial port or via a USB connection, please page 95 (Using Realterm to Establish a Remote Connection) for more information.

Using Realterm to Establish a Remote Connection

Background Realterm is a terminal program that can be used to communicate with a device attached to the serial port of a PC or via an emulated serial port via USB.

The following instructions apply to version 2.0.0.70. Even though Realterm is used as an example to establish a remote connection, any terminal program can be used that has similar functionality.



Note

Realterm can be downloaded on Sourceforge.net free of charge.

For more information please see <http://realterm.sourceforge.net/>

1. Install Realterm Download Realterm and install according to the instructions on the Realterm website.

2. Configure connection Connect the GOM-804/805 via USB (page 91) or via RS232 (page 93).

If using RS232, make note of the configured baud rate.

Go to the Windows device manager and find the COM port number for the connection.

For example in Windows 7, go to the Start menu > Control Panel > Hardware and Sound > Device Manager

Double click the Ports icon to reveal the connected serial port devices and the COM port for each connected device.

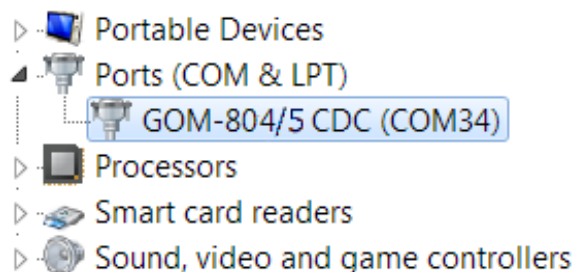

If using USB, the baud rate, stop bit and parity settings can be viewed by right-clicking connected device and selecting the Properties option.

2. Run Realterm Start Realterm on the PC as an administrator.

Click:

Start menu>All Programs>RealTerm>realterm

Tip: to run as an administrator, you can right click the Realterm icon in the Windows Start menu and select the Run as Administrator option.

After Realterm has started, click on the Port tab.

Enter the Baud, Parity, Data bits, Stop bits and Port number configuration for the connection.

The Hardware Flow Control and Software Flow Control options can be left at the default settings.

Press Open to connect to the GOM-804/805.

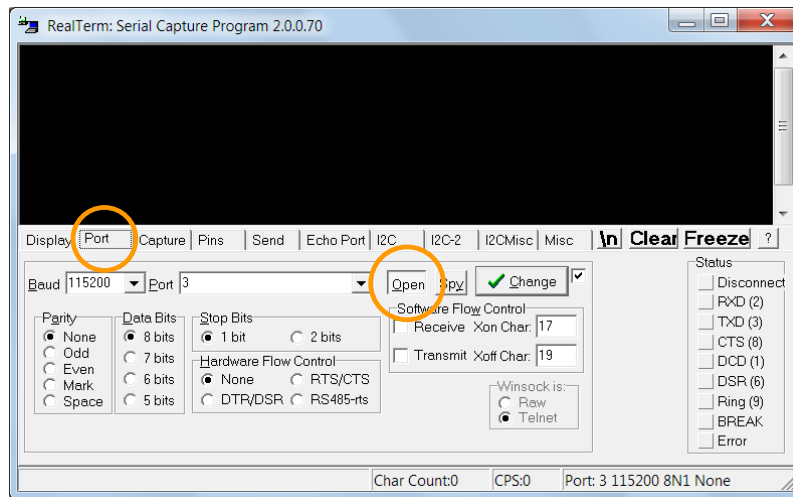

3. Test remote command

Click on the Send tab.

In the EOL configuration, check on the +CR and +LF check boxes.

Enter the query:

*idn?

Click on Send ASCII.

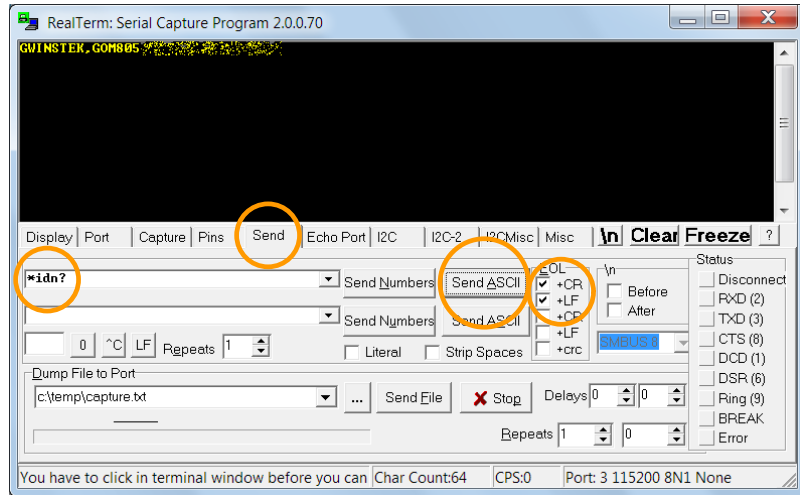

The terminal display will return the following:

GWINSTEK,GOM805,GXXXXXXXXXX,V1.00

(manufacturer, model, serial number, version)

4. Errors or Problems

If Realterm fails to connect to the GOM-804/805, please check all the cables and settings and try again.

GPIB Function

Background

Please use the National Instruments Measurement & Automation Controller software to confirm GPIB/LAN functionality.

See the National Instrument website, <http://www.ni.com> for details.

1. Operation

Start the NI Measurement and Automation Explorer (MAX) program. Using Windows, press:



Start>All Programs>National Instruments>Measurement & Automation



- Step a. From the Configuration panel access;
My System>Devices and Interfaces>GPIB0
- Step b. Press the Scan for Instruments button.
- Step c. In the Connected Instruments panel the GOM-804/805 should be detected as Instrument 0 with the address the same as that configured on the unit.
- Step d. Double click the Instrument 0 icon.

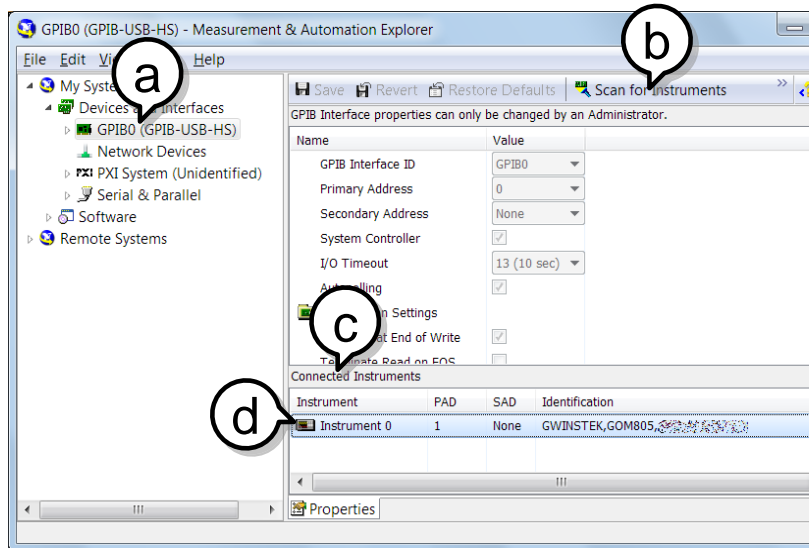

- Step e. Click on the Attributes tab at the bottom.
- Step f. Click on Communicate with Instrument.

Step g. In the NI-488.2 Communicator window, ensure *IND? is written in the Send String: text box.

Click on the Query button to send the *IDN? query to the instrument.

Step h. The String Received text box will display the query return:

GWINSTEK,GOM805,GXXXXXXXXX,V1.00

(manufacturer, model, serial number, version)

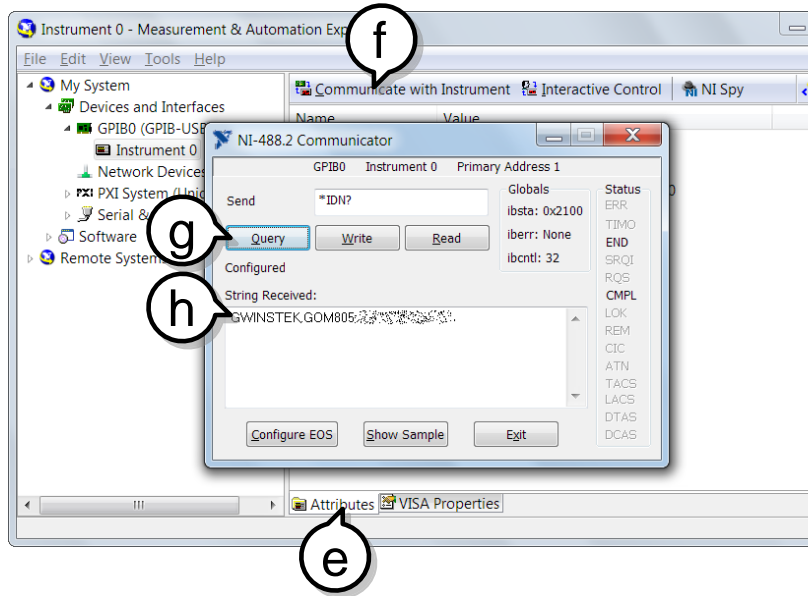

The function check is complete.

SAVE/RECALL

The settings for all the major functions can be saved and recalled from 20 memory slots.

Settings can saved/recalled for the following functions:
Ohm, Compare, Binning, TC, TCONV, TEMP, Scan, Diode.

Save/Recall Settings

Background The save function saves the current function as well the settings related to that function.
There are 20 memory slots that can be used to save and recall settings on the GOM-804/805.

1. Enter the Memory menu When you are in the desired function mode, press the  key (if necessary) to so that the menu system at the bottom of the display has focus.
Use the arrow keys to navigate to the Memory setting and press Enter.

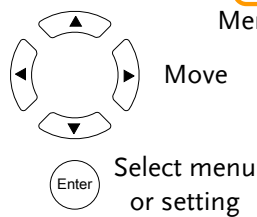
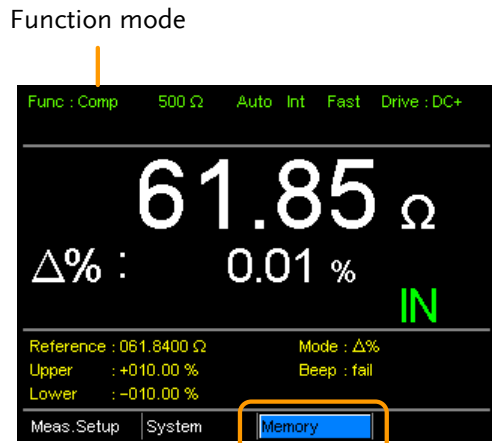

The Recall/Save Setup menu will appear.

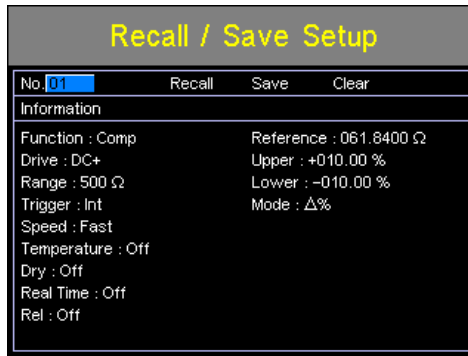

2. Save/ Recall/Clear Memory

The No. setting should be already highlighted when entering the Recall/Save Setup menu. If not, use the Left/Right arrow keys to highlight the No. setting.

No. setting Recall, Save, Clear settings

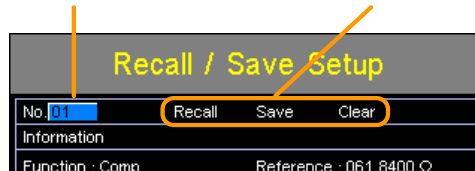

Use the up and down arrow keys to select a memory space.

Range 01~20

*If a memory space has been used before, the settings for that memory slot will also be shown on the display.

To Save:
Use the arrow keys to go to Save and press Enter.



To Recall:
Use the arrow keys to go to Recall and press Enter.



To Clear:
Use the arrow keys to go to Clear and press Enter.



Press Enter again when asked to confirm the selected operation.

After saving the settings, press ESC to return to the current function mode.

After recalling settings, the unit will automatically go to the recalled setting function.



Note

Pressing ESC before pressing Enter will exit the Save/Recall/Clear operation.

View memory slot availability

Press the Enter key when the No. setting is highlighted to see which memory slots are empty.

The status of memory slots 01 ~ 20 are shown at the bottom of the display.

Memory slots in red are empty slots while those in black have already been used.

Press Enter again to exit from this view.

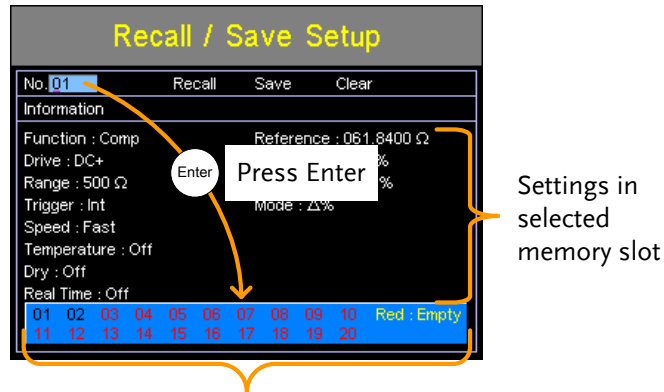

Settings in selected memory slot

Available memory slots in red.
Used memory slots in black.



Note

The memory number can also be selected when in the above view using the arrow keys.

COMMAND OVERVIEW

The Command overview chapter lists all the programming commands in alphabetical order. The command syntax section shows you the basic syntax rules you have to apply when using commands.

Command Syntax

Compatible Standard	IEEE488.2	Partial compatibility
	SCPI, 1994	Partial compatibility

Command Structure SCPI (Standard Commands for Programmable Instruments) commands follow a tree-like structure, organized into nodes. Each level of the command tree is a node. Each keyword in an SCPI command represents each node in the command tree. Each keyword (node) of an SCPI command is separated by a colon (:).

For example, the diagram below shows an SCPI sub-structure and a command example.

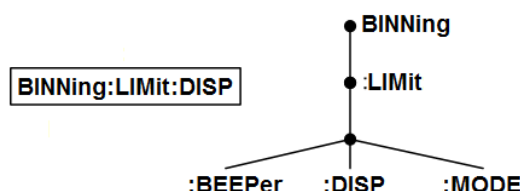

Command Types There are a number of different instrument commands and queries. A command sends instructions or data to the unit and a query receives data or status information from the unit.

Command Types

Simple A single command with/without a parameter

Example SENSE:FUNCTION OHM

Query A query is a simple or compound command followed by a question mark (?). A parameter (data) is returned.

Example SENSE:RANGe?

Command Forms Commands and queries have two different forms, long and short. The command syntax is written with the short form of the command in capitals and the remainder (long form) in lower case.

The commands can be written either in capitals or lower-case, just so long as the short or long forms are complete. An incomplete command will not be recognized.

Below are examples of correctly written commands.

Long form CALCulate:COMPare:BEEPer
 CACLULATE:COMPARE:BEEPER
 calculate:compare:beeper

Short form CALC:COMP:BEEP
 calc:comp:beep

Command Format

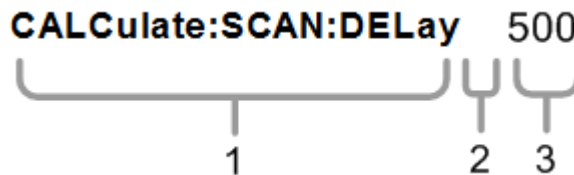

1. Command header
2. Space
3. Parameter

Common Input Parameters

Type	Description	Example
<Boolean>	boolean logic	0,1
<NR1>	integers	0,1,2,3
<NR2>	decimal numbers	0.1,3.14,8.5
<NR3>	floating point with exponent	4.5e-1,8.25e+1

	<NRf>	Any of NR1,2,3	1,1.5,4.5e-1
	<string>	ASCII text string	TEST_NAME
Message Terminator (EOL)	Marks the end of a command line. The following messages are in accordance with IEEE488.2 standard.		
	Remote Command	LF, CR, CR+LF, LF+CR	The most common EOL character is CR+LF
	Return Message	LF	User configurable (excluding GPIB) See page 71.
Message Separator	EOL or ;	Command separator.	

Command List

General Commands

SENSe:FUNcTion	109
SENSe:AUTo	109
SENSe:RANGe	110
SENSe:SPEEd	110
SENSe:REL:STATe.....	110
SENSe:REL:DATa.....	111
SENSe:REALtime:STATe.....	111
SENSe:DISPlay.....	111
TRIGger:SOURce.....	112
READ	112

Compare Commands

CALCulate:COMPare:TYPE	113
CALCulate:COMPare:LIMit:REFerence.....	113
CALCulate:COMPare:LIMit:MODE	113
CALCulate:COMPare:LIMit:LOWer	114
CALCulate:COMPare:LIMit:UPPer	114
CALCulate:COMPare:PERCent:LOWer	115
CALCulate:COMPare:PERCent:UPPer	115
CALCulate:COMPare:BEEPer	116
CALCulate:COMPare:MATH:DATa	116
CALCulate:COMPare:LIMit:RESult	116

Binning Commands

BINNING:COUNT:CLEar	118
BINNING:COUNT:TOTal	118
BINNING:COUNT:OUT.....	118
BINNING<X>:COUNT:RESult.....	118
BINNING<X>:LIMit:LOWer	119
BINNING<X>:LIMit:UPPer	119
BINNING<X>:PERCent:LOWer.....	120
BINNING<X>:PERCent:UPPer	120
BINNING:LIMit:BEEPer	121
BINNING:LIMit:DISP	121
BINNING:LIMit:MODE.....	121
BINNING:LIMit:REFerence	122
BINNING:LIMit:RESult.....	122

Temperature Compensate Commands

TEMPerature:COMPensate:CORRect	123
TEMPerature:COMPensate:COEFFicient	123

Temperature Conversion Commands

TEMPerature:CONVersion:RESistance	124
TEMPerature:CONVersion:TEMPerature	124
TEMPerature:CONVersion:CONStant	124
TEMPerature:CONVersion:DISPlay	125
TEMPerature:CONVersion:MATH:DATA	125

Temperature Commands

TEMPerature:STATe	126
TEMPerature:DATA	126

Scan Commands

CALCulate:SCAN:CHANnel	127
CALCulate:SCAN:DELAy	127
CALCulate:SCAN:LIMit:REFerence	127
CALCulate:SCAN:LIMit:MODE	128
CALCulate:SCAN:LIMit:LOWer	128
CALCulate:SCAN:LIMit:UPPer	128
CALCulate:SCAN:PERCent:LOWer	129
CALCulate:SCAN:PERCent:UPPer	129
MEASure<X>	130
SHOW	130

Source Commands

SOURce:DRY	131
SOURce:DRIVe	131

Meas. Setup Commands

SYSTem:AVERAge:STATe	132
SYSTem:AVERAge:DATA	132
SYSTem:MDELay:STATe	132
SYSTem:MDELay:DATA	133
TRIGger:DELAy:STATe	133
TRIGger:DELAy:DATA	133
TRIGger:EDGE	134
TEMPerature:UNIT	134
TEMPerature:AMBient:STATe	134
TEMPerature:AMBient:DATA	135

SYSTem:LFRequency	135
SYSTem:PWM:ON	136
SYSTem:PWM:OFF	136

System Commands

*IDN	137
SYSTem:SERial	137
SYSTem:BRIGHtness	137
USERdefine<X>:ACTive	137
USERdefine<X>:FIRStdata	138
USERdefine<X>:LOGic	138
USERdefine<X>:SEConddata	139
SYSTem:HANDler.....	139
SYSTem:KEYClick:BEEPer	139
SYSTem:VOLTage:PROTect	140
SYSTem:ERRor	140
SYSTem:LOCal	141
SYSTem:VERSion.....	141

Memory Commands

MEMory:SAVe	142
MEMory:RECall	142
MEMory:CLEar	142
MEMory:STATe	142

Status Commands

STATus:PRESet	144
STATus:QUESTionable:ENABLE.....	144
STATus:QUESTionable:EVENT	144

IEEE 488.2 Common Commands

*CLS	145
*ESE	145
*ESR	145
*OPC	146
*RST	146
*SRE	146
*STB	147
*TRG.....	147

General Commands

SENSe:FUNcTion





Description	Sets or returns the function mode.	
Syntax	SENSe:FUNcTion {OHM COMP BIN TC TCONV SCAN DIODE}	
Query Syntax	SENSe:FUNcTion?	
Parameter/ Return parameter	OHM	OHM MODE
	COMP	COMP MODE
	BIN	BIN MODE
	TC	TC MODE
	TCONV	TCONV MODE
	OHM+T*	TEMP MODE*
	SCAN	SCAN MODE
	DIODE	DIODE MODE
Example	SENS:FUNC OHM Sets ohm mode on.	
Note *	For set to TEMP (OHM+T) function, please use command at Temperature commands section.	

SENSe:AUTo

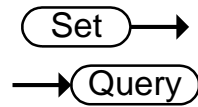

Description	Sets or returns the auto-range state.	
Syntax	SENSe:AUTo <NR1> {OFF ON}	
Query Syntax	SENSe:AUTo?	
Parameter/ Return parameter	<NR1>	0:OFF. 1:ON.
	OFF	Auto-Range is off.
	ON	Auto-Range is on.
Example	SENS:AUT ON Sets auto-range mode on.	

SENSe:RANGe



Description	Sets or returns the range of the present function.	
Syntax	SENSe:RANGe <NRf>	
Query Syntax	SENSe:RANGe?	
Parameter	<NRf>	5E-3~ 5E+6
Return parameter	<NR3>	5E-3 ~ 5E+6
Example	SENSe:RANG 0.005 Sets range to 5mΩ. SENSe:RANG? >5.0000E-3 Returns the range as 5mΩ.	

SENSe:SPEEd

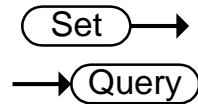

Description	Sets or returns the measurement speed.	
Syntax	SENSe:SPEEd {SLOW FAST}	
Query Syntax	SENSe:SPEEd?	
Parameter/ Return parameter	SLOW	Measurement speed is slow.
	FAST	Measurement speed is fast.
Example	SENSe:SPE FAST Sets measurement speed to the fast rate.	

SENSe:REL:STATe

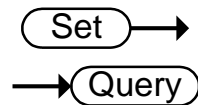

Description	Sets or returns the relative function state.	
Syntax	SENSe:REL:STATe <NR1> {OFF ON}	
Query Syntax	SENSe:REL:STATe?	
Parameter/ Return parameter	<NR1>	0:OFF. 1:ON.
	OFF	Turn the relative function off.
	ON	Turn the relative function on.
Example	SENSe:REL:STAT OFF Sets the relative function off.	

Note The SENS:REL:STAT can only be turned ON when measured vale is displayed.

SENSe:REL:DATa

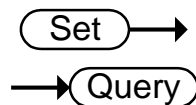

Description	Sets or returns the relative value for the relative function.	
Syntax	SENSe:REL:DATa <NRf>	
Query Syntax	SENSe:REL:DATa?	
Parameter	<NRf>	0.0000~500.00 The unit will be auto set by the present range.
Return parameter	<NR3>	±0.0000~5.1000E±X
Example	SENS:REL:DAT 490.32 Sets the relative function value to 490.32Ω. SENS:REL:DAT? >4.9032E+2 Returns the relative value (490.32Ω).	

Note The SENS:REL:DAT can only be set when measured vale is displayed.

SENSe:REALtime:STATe

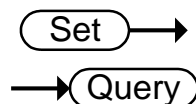

Description	Sets or returns the real time function state.	
Syntax	SENSe:REALtime:STATe <NR1> {OFF ON}	
Query Syntax	SENSe:REALtime:STATe?	
Parameter/ Return parameter	<NR1>	0:OFF. 1:ON.
	OFF	Turn the real time function off.
	ON	Turn the real time function on.
Example	SENS:REAL:STAT ON Turns the real time function on.	

SENSe:DISPlay

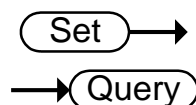

Description Sets or returns the display mode. There are two display modes, normal and simple.

Syntax	SENSe:DISPlay <NR1> {OFF ON}	
Query Syntax	SENSe:DISPlay?	
Parameter/ Return parameter	<NR1>	0:OFF. 1:ON.
	OFF	Display mode is normal.
	ON	Display mode is simple.
Example	SENS:DISP OFF Sets the display mode to normal.	

Set →

→ Query

TRIGger:SOURce

Description	Sets or returns current trigger source.	
Syntax	TRIGger:SOURce {INT EXT}	
Query Syntax	TRIGger:SOURce?	
Parameter/ Return parameter	INT	Internal trigger mode.
	EXT	External trigger mode.
Example	TRIG:SOUR EXT Sets the current trigger source to external trigger.	

READ

→ Query

Description	Returns the measurement value.	
Query Syntax	READ?	
Return parameter	<NR3>	±0.0000~5.1000E±X
Example	READ? >+2.2012E+0 Returns the measurement.	
Note	+9.0000E+9: it indicates measure value is OverRange. +9.9999E+9: it indicates the HVP is detected.	

Compare Commands

CALCulate:COMPare:TYPE

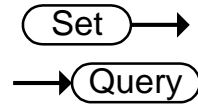

Description	Sets or returns the compared function.	
Syntax	CALCulate:COMPare:TYPE {OHM TC}	
Query Syntax	CALCulate:COMPare:TYPE?	
Parameter/ Return parameter	OHM	OHM function.
	TC	TC function.
Example	CALC:COMP:TYPE TC Sets the compare to TC function.	

CALCulate:COMPare:LIMit:REFerence

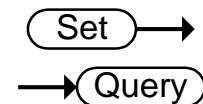

Description	Sets or returns the limit reference value for the compare function.	
Syntax	CALCulate:COMPare:LIMit:REFerence {<NRf>[,<String>]}	
Query Syntax	CALCulate:COMPare:LIMit:REFerence?	
parameter	<NRf>	000.0001~999.9999
	<String>	mohm/ohm/kohm/maohm,unit If unit is not set, the unit will be automatically set by the present range.
Return parameter	<NR3>	000.0001~999.9999E±X
Example	CALC:COMP:LIM:REF 10.00,mohm Sets the limit reference value to 10.00mΩ. CALC:COMP:LIM:REF? >10.0000E-3 Returns the limit as 10.00mΩ.	

CALCulate:COMPare:LIMit:MODE

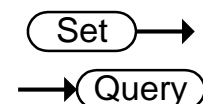

Description	Sets or returns the compare mode for the compare function.	
-------------	--	--



Syntax	CALCulate:COMPare:LIMit:MODE {ABS DPER PER}	
Query Syntax	CALCulate:COMPare:LIMit:MODE?	
Parameter/ Return parameter	ABS	The test results are judged from absolute values.
	DPER	The test results are judged from a reference value \pm a percentage offset. (delta percentage)
	PER	The test results are displayed as a percentage of the reference value.
Example	CALC:COMP:LIM:MODE ABS Sets test results as absolute values for the compare function.	

CALCulate:COMPare:LIMit:LOWer



Description	Sets or returns the lower limit value for the compare function.	
Syntax	CALCulate:COMPare:LIMit:LOWer {<NRf>[,<String>]}	
Query Syntax	CALCulate:COMPare:LIMit:LOWer?	
Parameter	<NRf>	000.0000~999.9999
	<String>	mohm/ohm/kohm/maohm,unit If the unit is not set, the unit will be automatically set by the present range.
Return parameter	<NR3>	000.0000~999.9999E \pm X
Example	CALC:COMP:LIM:LOW 0.95,kohm Sets the lower limit value to 0.95k Ω . CALC:COMP:LIM:LOW? >0.9500E+3 Returns the lower limit as 0.95k Ω .	

Note This command is only applicable when compare mode is set to ABS for compare function.

CALCulate:COMPare:LIMit:UPPer



Description	Sets or returns the upper limit value for the compare function.	
-------------	---	--

Syntax	CALCulate:COMPare:LIMit:UPPer {<NRf>[,<String>]}	
Query Syntax	CALCulate:COMPare:LIMit:UPPer?	
Parameter	<NRf>	000.0000~999.9999
	<String>	mohm/ohm/kohm/maohm,unit If unit is not set, the unit will be automatically set by the present range.
Return parameter	<NR3>	000.0000~999.9999E±X
Example	CALC:COMP:LIM:UPP 0.123,maohm Sets the upper limit value to 0.123MΩ. CALC:COMP:LIM:UPP? >0.1230E+6 Returns the upper limit as 0.123MΩ.	
Note	This command is only applicable when compare mode is set to ABS for compare function.	

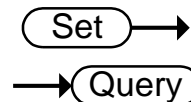
CALCulate:COMPare:PERCent:LOWer



Description	Sets or returns the lower limit percent value for the compare function.	
Syntax	CALCulate:COMPare:PERCent:LOWer <NRf>	
Query Syntax	CALCulate:COMPare:PERCent:LOWer?	
Parameter	<NRf>	000.00~999.99
Return parameter	<NR2>	000.00~999.99
Example	CALC:COMP:PERC:LOW 10.00 Sets the lower limit percent value to -10.00%. CALC:COMP:PERC:LOW? >10.00 Returns the lower limit as -10.00%.	
Note	This command is only applicable when compare mode is set to DPER or PER for compare function.	

CALCulate:COMPare:PERCent:UPPer

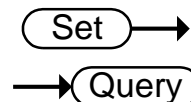

Description	Sets or returns the upper limit percent value for the compare function.	
Syntax	CALCulate:COMPare:PERCent:UPPer <NRf>	
Query Syntax	CALCulate:COMPare:PERCent:UPPer?	

Parameter	<NRf>	000.00~999.99
Return parameter	<NR2>	000.00~999.99
Example	CALC:COMP:PERC:UPP 90.00 Sets the upper limit percent value to +90.00%. CALC:COMP:PERC:UPP? >90.00 Returns the upper limit as +90.00%.	
Note	This command is only applicable when compare mode is set to DPER or PER for compare function.	

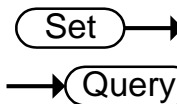

CALCulate:COMPare:BEEPer

Description	Sets or returns the compare function beeper mode.	
Syntax	CALCulate:COMPare:BEEPer {OFF PASS FAIL}	
Query Syntax	CALCulate:COMPare:BEEPer?	
Parameter/ Return parameter	OFF	Turns the beeper off.
	PASS	The beeper will sound on a pass test result.
	FAIL	The beeper will sound on a fail test result.
Example	CALC:COMP:BEEP FAIL Sets the beeper on when the test result is a fail.	

CALCulate:COMPare:MATH:DATA



Description	Returns the deviation value for the compare function.	
Query Syntax	CALCulate:COMPare:MATH:DATA?	
Return parameter	<NR3>	$\pm 0.0000 \sim 9.9999E \pm X$.
Example	CALC:COMP:MATH:DAT? >+0.3658E+2 Returns the deviation as 36.58%.	

CALCulate:COMPare:LIMit:RESult

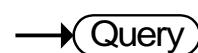

Description	Returns the compare function test result.	
Query Syntax	CALCulate:COMPare:LIMit:RESult?	

Return parameter	<NR1>	0: LO 1: IN 2: HI
------------------	-------	-------------------------

Example CALC:COMP:LIM:RES?
 >2
 Indicates that the test result is HI.

Binning Commands

Binning commands are only applicable to GOM-805.

BINNING:COUNT:CLEAr

Set →

Description	Clear all bin sorting function test result counts.
Syntax	BINNING:COUNT:CLEAr
Parameter/	<None>

BINNING:COUNT:TOTal

→ Query

Description	Returns the total number (count total) of test bin results.
Query Syntax	BINNING:COUNT:TOTAL?
Return parameter	<NR1> 0~999999999
Example	BINN:COUN:TOT? >150 Indicates that the total number (count total) of test results (pass and fail) is 150.

BINNING:COUNT:OUT

→ Query

Description	Returns the number of failed (judged OUT) test results for the bin sorting function test.
Query Syntax	BINNING:COUNT:OUT?
Return parameter	<NR1> 0~999999999
Example	BINN:COUN:OUT? >50 Indicates that the number of failed test results is 50.

BINNING<X>:COUNT:RESult

→ Query

Description	Returns the number of passed (judged IN) test results for the selected bin.
-------------	---

Query Syntax	BINNing<X>:COUNT:RESult?	
Parameter	<X>	1~8
Return parameter	<NR1>	0~99999999
Example	BINN1:COUN:RES? >100 Indicates that bin1 has a pass count of 100.	

Set →

→ Query

BINNing<X>:LIMit:LOWer

Description	Sets or returns the lower limit value (absolute value) for the selected bin.	
Syntax	BINNing<X>:LIMit:LOWer {<NRf>[,<String>]}	
Query Syntax	BINNing<X>:LIMit:LOWer?	
Parameter	<X>	1~8
	<NRf>	000.0000~999.9999
	<String>	mohm/ohm/kohm/maohm,unit If the unit is not set, the unit will be automatically set by the present range.
Return parameter	<NR3>	000.0000~999.9999E±X
Example	BINN1:LIM:LOW 23.8,kohm Sets the bin1 lower limit value to 23.8kΩ. BINN1:LIM:LOW? >23.8000E+3 Returns the lower limit as 23.8kΩ.	

Set →

→ Query

BINNing<X>:LIMit:UPPer

Description	Sets or returns the upper limit value (absolute value) for the selected bin.	
Syntax	BINNing<X>:LIMit:UPPer {<NRf>[,<String>]}	
Query Syntax	BINNing<X>:LIMit:UPPer?	
Parameter	<X>	1~8
	<NRf>	000.0000~999.9999
	<String>	mohm/ohm/kohm/maohm,unit If the unit is not set, the unit will be automatically set by the present range.

Return parameter	<NR3>	000.0000~999.9999E±X
Example	BINN1:LIM:UPP 0.95,maohm Sets bin1 upper limit value to 0.95MΩ. BINN1:LIM:UPP? >0.9500E+6 Returns the upper limit as 0.95MΩ.	

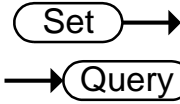

BINNING<X>:PERCENT:LOWer

Description	Sets or returns the lower value percentage value for the selected bin. The value is a percentage offset from the reference value.	
Syntax	BINNING<X>:PERCENT:LOWer <NRf>	
Query Syntax	BINNING<X>:PERCENT:LOWer?	
Parameter	<X>	1~8
	<NRf>	000.00~999.99
Return parameter	<NR2>	000.00~999.99
Example	BINN1:PERC:LOW 10.15 Sets the bin1 lower limit percent value to -10.15%. BINN1:PERC:LOW? >10.15 Returns the lower limit percentage value as -10.15%.	

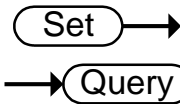

BINNING<X>:PERCENT:UPPer

Description	Sets or returns the upper value percentage value for the selected bin. The value is a percentage offset from the reference value.	
Syntax	BINNING<X>:PERCENT:UPPer <NRf>	
Query Syntax	BINNING<X>:PERCENT:UPPer?	
Parameter	<X>	1~8
	<NRf>	000.00~999.99
Return parameter	<NR2>	000.00~999.99

Example BINN1:PERC:UPP 150.95
 Sets the bin1 upper limit percent value to +150.95%.
 BINN1:PERC:UPP?
 >150.95
 Returns the upper limit percentage value as +150.95%.

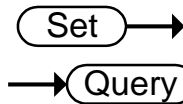

BINNing:LIMit:BEEPer

Description	Sets or returns beeper mode for the bin sorting function.	
Syntax	BINNing:LIMit:BEEPer {OFF PASS FAIL}	
Query Syntax	BINNing:LIMit:BEEPer?	
Parameter/ Return parameter	OFF	Turns the beeper off.
	PASS	The beeper will sound on a pass test result.
	FAIL	The beeper will sound on a fail test result.

Example BINN:LIM:BEEP OFF
 Turns the beeper off.

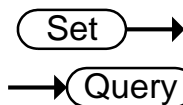

BINNing:LIMit:DISP

Description	Sets or returns the bin sorting function display mode.	
Syntax	BINNing:LIMit:DISP {COMP COUNT}	
Query Syntax	BINNing:LIMit:DISP?	
Parameter/ Return parameter	COMP	The display is set to compare mode.
	COUNT	The display is set to count mode.

Example BINN:LIM:DISP COMP
 Sets the bin sorting function display mode to compare.

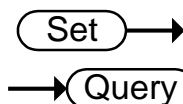

BINNing:LIMit:MODE

Description	Sets or returns the setting mode for upper and lower limits (absolute or $\Delta\%$).	
Syntax	BINNing:LIMit:MODE {ABS DPER}	
Query Syntax	BINNing:LIMit:MODE?	

Parameter/ Return parameter	ABS	The test results are judged from absolute values.
	DPER	The test results are judged from a reference value \pm a percentage offset. (delta percent)

Example BINN:LIM:MODE DPER
Sets the mode to $\Delta\%$.

Set →

→ Query

BINNING:LIMit:REference

Description	Sets or returns the limit reference value for the bin sorting function.	
Syntax	BINNING:LIMit:REference {<NRf>[,<String>]}	
Query Syntax	BINNING:LIMit:REference?	
Parameter	<NRf>	000.0001~999.9999
	<String>	mohm/ohm/kohm/maohm,unit If the unit is not set, the unit will be automatically set by the present range.
Return parameter	<NR3>	000.0001~999.9999E \pm X
Example	BINN:LIM:REF 100 Sets the limit reference value to 100 Ω . BINN:LIM:REF? >100.0000E+0 Returns the reference as 100 Ω .	

BINNING:LIMit:RESult

→ Query

Description	Returns the bin sorting function test result.	
Query Syntax	BINNING:LIMit:RESult?	
Return parameter	<NR1>	1~8: Bin1~Bin8 9: Bin Out
Example	BINN:LIM:RES? >1 Indicates a pass for bin1.	

Temperature Compensate Commands

TEMPerature:COMPensate:CORRect  

Description Sets or returns the reference temperature for the temperature compensation function.

Syntax TEMPerature:COMPensate:CORRect <NRf>
Query Syntax TEMPerature:COMPensate:CORRect?

Parameter <NRf> -50.0~399.9 (Unit: °C)

Return parameter <NR2> -50.0~399.9 (Unit: °C)

Example TEMP:COMP:CORR 25.5
 Sets the reference temperature to 25.5°C.

TEMPerature:COMPensate:COEFFicient  

Description Sets or returns the temperature coefficient for temperature compensation function.

Syntax TEMPerature:COMPensate:COEFFicient <NR1>
Query Syntax TEMPerature:COMPensate:COEFFicient?

**Parameter/
Return parameter** <NR1> -9999~+9999



Example TEMP:COMP:COEF 3930
 Sets the temperature coefficient to 3930ppm.

Temperature Conversion Commands

TEMPerature:CONVersion:RESistance



Description	Sets or returns the initial resistance for the temperature conversion function.	
Syntax	TEMPerature:CONVersion:RESistance {<NRf>[,<String>]}	
Query Syntax	TEMPerature:CONVersion:RESistance?	
Parameter	<NRf>	000.0001~999.9999
	<String>	mohm/ohm/kohm/maohm,unit If the unit is not set, the unit will be automatically set by the present range.
Return parameter	<NR3>	000.0001~999.9999E±X
Example	TEMP:CONV:RES 10.00,maohm Sets initial resistance value to 10.00MΩ. TEMP:CONV:RES? >10.0000E+6 Returns the initial resistance as 10.00MΩ.	

TEMPerature:CONVersion:TEMPerature



Description	Sets or returns the initial temperature for the temperature conversion function.	
Syntax	TEMPerature:CONVersion:TEMPerature <NRf>	
Query Syntax	TEMPerature:CONVersion:TEMPerature?	
Parameter	<NRf>	-50.0~399.9 (Unit: °C)
Return parameter	<NR2>	-50.0~399.9 (Unit: °C)
Example	TEMP:CONV:TEMP 25.6 Sets the initial temperature to +25.6°C.	

TEMPerature:CONVersion:CONStant



Description	Sets or returns the temperature constant for the temperature conversion function.	
-------------	---	--

Syntax	TEMPerature:CONVersion:CONStant <NRf>	
Query Syntax	TEMPerature:CONVersion:CONStant?	
Parameter	<NRf>	0.0~999.9
Return parameter	<NR2>	0.0~999.9
Example	TEMP:CONV:CONS 235 Sets the temperature constant to 235.	

TEMPerature:CONVersion:DISPlay

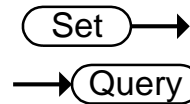

Description	Sets or returns the temperature display mode for the temperature conversion function.	
Syntax	TEMPerature:CONVersion:DISPlay <NR1>	
Query Syntax	TEMPerature:CONVersion:DISPlay?	
Parameter/ Return parameter	<NR1>	1: ΔT 2: T
Example	TEMP:CONV:DISP 1 Sets the temperature display mode for the temperature conversion function is ΔT .	

TEMPerature:CONVersion:MATH:DATA



Description	Returns conversion function deviation value.	
Query Syntax	TEMPerature:CONVersion:MATH:DATA?	
Return parameter	<NR3>	$\pm 0.000 \sim 9.999E \pm X$
Example	TEMP:CONV:MATH:DAT? Returns 1.250E+2.	

Temperature Commands

TEMPerature:STATe (Set) →
→ (Query)

Description	Sets or returns the temperature function state.	
Syntax	TEMPerature:STATe {<NR1> OFF ON}	
Query Syntax	TEMPerature:STATe?	
Parameter/ Return parameter	<NR1>	0:OFF 1:ON
	OFF	Turn the temp function off.
	ON	Turn the temp function on.
Example	TEMP:STAT ON Sets the TEMP (Ohm+T) function on.	

TEMPerature:DATA → (Query)

Description	Returns the PT-100 sensor temperature measurement in degrees Celsius.	
Query Syntax	TEMPerature:DATA?	
Return parameter	<NR3>	-50.0~399.9
Example	TEMP:DAT? >0.250E+2 Returns the temperature as 25°C.	

Scan Commands

CALCulate:SCAN:CHANnel

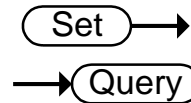

Description	Sets or returns the channel for the scan function.	
Syntax	CALCulate:SCAN:CHANnel <NR1>	
Query Syntax	CALCulate:SCAN:CHANnel?	
Parameter/ Return parameter	<NR1>	1~100
Example	CALC:SCAN:CHAN 5 Sets the channel to 5.	

CALCulate:SCAN:DELay

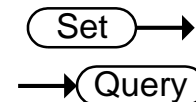

Description	Sets or returns the interval delay for the scan function.	
Syntax	CALCulate:SCAN:DELay <NR1>	
Query Syntax	CALCulate:SCAN:DELay?	
Parameter/ Return parameter	<NR1>	400~30000 Unit:ms
Example	CALC:SCAN:DEL 500 Sets interval delay of the scan to 500ms.	

CALCulate:SCAN:LIMit:REFerence

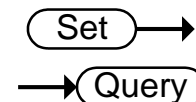

Description	Sets or returns the reference limit for the scan function.	
Syntax	CALCulate:SCAN:LIMit:REFerence {<NRf>[,<String>]}	
Query Syntax	CALCulate:SCAN:LIMit:REFerence?	
Parameter	<NRf>	000.0001~999.9999
	<String>	mohm/ohm/kohm/maohm,unit If unit is not set,the unit will be automatically set by the present range.
Return parameter	<NR3>	000.0001~999.9999E±X

Example `CALC:SCAN:LIM:REF 10.00,mohm`
 Sets the reference limit to 10.00mΩ.
`CALC:SCAN:LIM:REF?`
`>10.0000E-3`
 Returns the reference limit as 10.00mΩ.

Set →

→ Query

CALCulate:SCAN:LIMit:MODE

Description	Sets or returns the scan function compare mode.	
Syntax	<code>CALCulate:SCAN:LIMit:MODE {ABS DPER}</code>	
Query Syntax	<code>CALCulate:SCAN:LIMit:MODE?</code>	
Parameter/ Return parameter	ABS	The test results are judged from absolute values.
	DPER	The test results are judged from a reference value ± a percentage offset. (delta percent)

Example `CALC:SCAN:LIM:MODE ABS`
 Sets compare mode to absolute values.

Set →

→ Query

CALCulate:SCAN:LIMit:LOWer

Description	Sets or returns the lower limit value for the scan function.	
Syntax	<code>CALCulate:SCAN:LIMit:LOWer {<NRf>[,<String>]}</code>	
Query Syntax	<code>CALCulate:SCAN:LIMit:LOWer?</code>	
Parameter	<NRf>	000.0000~999.9999
	<String>	mohm/ohm/kohm/maohm,unit If unit is not set, the unit will be automatically set by the present range.
Return parameter	<NR3>	000.0000~999.9999E±X

Example `CALC:SCAN:LIM:LOW 1.37,kohm`
 Sets the lower limit value to 1.37kΩ.
`CALC:SCAN:LIM:LOW?`
`>1.3700E+3`
 Returns the lower limit as 1.37kΩ.

Set →

→ Query

CALCulate:SCAN:LIMit:UPPer

Description	Sets or returns upper limit of the scan function.	
Syntax	CALCulate:SCAN:LIMit:UPPer {<NRf>[,<String>]}	
Query Syntax	CALCulate:SCAN:LIMit:UPPer?	
Parameter	<NRf>	000.0000~999.9999
	<String>	mohm/ohm/kohm/maohm,unit If unit is not set, the unit will be automatically set by the present range.
Return parameter	<NR3>	000.0000~999.9999E±X
Example	CALC:SCAN:LIM:UPP 0.123,maohm Sets the upper limit to 0.123MΩ. CALC:SCAN:LIM:UPP? >0.1230E+6 Returns the upper limit as 0.123MΩ.	

CALCulate:SCAN:PERCent:LOWer



Description	Sets or returns lower limit percent value for the scan function.	
Syntax	CALCulate:SCAN:PERCent:LOWer <NRf>	
Query Syntax	CALCulate:SCAN:PERCent:LOWer?	
Parameter	<NRf>	000.00~999.99
Return parameter	<NR2>	000.00~999.99
Example	CALC:SCAN:PERC:LOW 10.00 Sets the lower limit percent value to -10.00%. CALC:SCAN:PERC:LOW? >10.00 Returns the lower limit as -10.00%.	

CALCulate:SCAN:PERCent:UPPer



Description	Sets or returns the upper limit percent value for the scan function.	
Syntax	CALCulate:SCAN:PERCent:UPPer <NRf>	
Query Syntax	CALCulate:SCAN:PERCent:UPPer?	
Parameter	<NRf>	000.00~999.99
Return parameter	<NR2>	000.00~999.99

Example CALC:SCAN:PERC:UPP 90.00
 Sets the upper limit percent value to +90.00%.
 CALC:SCAN:PERC:UPP?
 >90.00
 Returns the upper limit as +90.00%.

MEASure<X>

→ Query

Description Returns the results of the selected channel in the scan mode, including HI/LO/IN and value.

Query Syntax MEASure<X>?

Parameter <X> Channel 1~100

Return parameter 0|1|2,<NR3> 0:LO
 1:IN
 2:HI
 <NR3>: Measurement result.

Example MEAS1?
 >1,+0.9978E+1
 Returns channel 1 is IN as 9.978Ω.

SHOW

→ Query

Description Returns the judgments of all (up to 100) channels in the scan mode.

Query Syntax SHOW?

Return parameter <String> 100 characters
 0:LO
 1:IN
 2:HI
 _:Channel not active

Example SHOW?
 Returns
 1111111111_____

 _____.

Source Commands

Source commands are only applicable to GOM-805.

SOURce:DRY

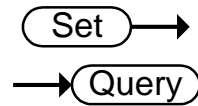

Description	Sets or returns the dry circuit test mode. Only applicable to the GOM-805.	
Syntax	SOURce:DRY {<NR1> {OFF ON}}	
Query Syntax	SOURce:DRY?	
Parameter/ Return parameter	<NR1>	0:OFF. 1:ON.
	OFF	Turn dry circuit test mode off.
	ON	Turn dry circuit test mode on.
Example	SOUR:DRY On Turns the dry circuit test mode on.	

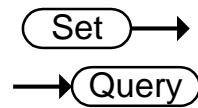

SOURce:DRIVE

Description	Sets or returns the drive mode.	
Syntax	SOURce:DRIVE <NR1>	
Query Syntax	SOURce:DRIVE?	
Parameter/ Return parameter	<NR1>	1: the DC+ mode.
		2: the DC- mode.
		3: the PULSE mode.
		4: the PWM mode.
		5: the ZERO mode.
		6: the STANDBY mode
Example	SOUR:DRIV 3 Sets the drive mode to pulse.	

Meas. Setup Commands

SYSTEM:AVERage:STATe



Description	Sets or returns the average function state.	
Syntax	SYSTEM:AVERage:STATe <NR1> {OFF ON}	
Query Syntax	SYSTEM:AVERage:STATe?	
Parameter/ Return parameter	<NR1>	0:OFF. 1:ON.
	OFF	Turn the average function off.
	ON	Turn the average function on.
Example	SYST:AVER:STAT OFF Turns the average function off.	

SYSTEM:AVERage:DATA



Description	Sets or returns the number of measurements used for the average function.	
Syntax	SYSTEM:AVERage:DATA <NR1>	
Query Syntax	SYSTEM:AVERage:DATA?	
Parameter/ Return parameter	<NR1>	2~100
Example	SYST:AVER:DAT 5 5 measurements are used to perform the average function.	

SYSTEM:MDElay:STATe



Description	Sets or returns the measurement delay function state.	
Syntax	SYSTEM:MDElay:STATe <NR1> {OFF ON}	
Query Syntax	SYSTEM:MDElay:STATe?	
Parameter/ Return parameter	<NR1>	0:OFF. 1:ON.

OFF	Turn the measurement delay off.
ON	Turn the measurement delay on.

Example SYST:MDEL:STAT OFF
Turns the measurement delay function off.

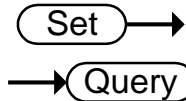

SYSTem:MDELAy:DATA

Description	Sets or returns the measurement delay time.	
Syntax	SYSTem:MDELAy:DATA <NRf>	
Query Syntax	SYSTem:MDELAy:DATA?	
Parameter/ Return parameter	<NRf>	0.000~100.000 Unit:ms For values under 1s, the unit resolution is 1ms. For values above 1s, the unit resolution is 0.1s.

Example SYST:MDEL:DAT 1.105
Sets the delay time of measure is 1.1s.
SYST:MDEL:DAT?
>001.100
Returns the measurement delay as 1.1s.

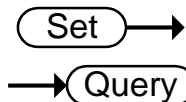

TRIGger:DELAy:STATe

Description	Sets or returns the trigger delay function state.	
Syntax	TRIGger:DELAy:STATe <NR1> {OFF ON}	
Query Syntax	TRIGger:DELAy:STATe?	
Parameter/ Return parameter	<NR1>	0:ON 1:OFF
	OFF	Turn the trigger delay function off.
	ON	Turn the trigger delay function on.

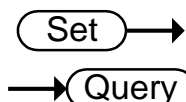

TRIGger:DELAy:DATA

Description Sets or returns the trigger delay time.

Syntax	TRIGger:DElay:DATA <NR1>	
Query Syntax	TRIGger:DElay:DATA?	
Parameter/ Return parameter	<NR1>	0~1000 Unit:ms
Example	TRIG:DEL:DAT 100 Sets the trigger delay time to 100ms.	

TRIGger:EDGE

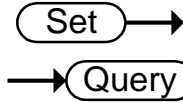

Description	Sets or returns the trigger edge (falling or rising edge).	
Syntax	TRIGger:EDGE {RISING FALLING}	
Query Syntax	TRIGger:EDGE?	
Parameter/ Return parameter	RISING	Select rising trigger.
	FALLING	Select falling trigger.
Example	TRIG:EDGE FALLING Sets the trigger to falling edge.	

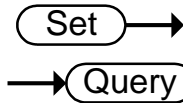

TEMPerature:UNIT

Description	Sets or returns the temperature unit. (Only used for the display readback.)	
Syntax	TEMPerature:UNIT {DEGC DEGF}	
Query Syntax	TEMPerature:UNIT?	
Parameter/ Return parameter	DEGC	°C
	DEGF	°F
Example	TEMP:UNIT DEGF Sets temperature unit to °F (Fahrenheit).	

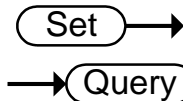

TEMPerature:AMBient:STATe

Description	Sets or returns the state of the user-set ambient temperature.	
Syntax	TEMPerature:AMBient:STATe <NR1> {OFF ON}	
Query Syntax	TEMPerature:AMBient:STATe?	

Parameter/ Return parameter	<NR1>	0:OFF. 1:ON.
	OFF	Disables the user-set ambient temperature.
	ON	Enables the user-set ambient temperature.

Example TEMP:AMB:STAT OFF
 Disables the user-set ambient temperature.

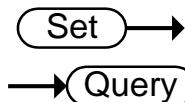

TEMPerature:AMBient:DATA

Description Sets or returns the user-set ambient temperature value for the temperature compensation and the temperature conversion function.

Syntax TEMPerature:AMBient:DATA <NRf>
 Query Syntax TEMPerature:AMBient:DATA?

Parameter	<NRf>	-50.0~399.9 (Unit: °C)
Return parameter	<NR2>	-50.0~399.9 (Unit: °C)

Example TEMP:AMB:DAT 25.6
 Sets the user ambient temperature value to +25.6°C.
 TEMP:AMB:DAT?
 >25.6
 Returns the set ambient temperature as 25.6°C.

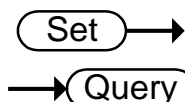

SYSTEM:LFRrequency

Description Sets or returns the frequency setting for the line filter.

Syntax SYSTEM:LFRrequency {AUTO | 50 | 60}
 Query Syntax SYSTEM:LFRrequency?

Parameter/ Return parameter	AUTO	The frequency setting for the line filter is automatically detected.
	50	The frequency is 50Hz.
	60	The frequency is 60Hz.

Example SYST:LFR 60
 Sets the line frequency to 60Hz.
 SYST:LFR?
 >60Hz
 Returns the line frequency as 60Hz.

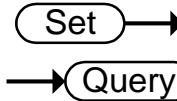

SYSTem:PWM:ON

Description Sets or returns the duty ON period for the PWM drive mode.

 **Note** PWM drive mode is only available for the GOM-805.

Syntax SYSTem:PWM:ON <NR1>
 Query Syntax SYSTem:PWM:ON?

Parameter/
 Return parameter <NR1> 3~99
 Unit: time units. For 60Hz LF, each unit is equal 16.6ms. For 50Hz LF, each unit is equal to 20.0ms.

Example SYST:PWM:ON 5
 Sets the duty ON time to 5 adc units.

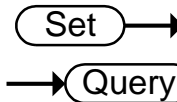

SYSTem:PWM:OFF

Description Sets or returns the duty OFF period for the PWM drive mode.

Syntax SYSTem:PWM:OFF <NR1>
 Query Syntax SYSTem:PWM:OFF?

Parameter/
 Return parameter <NR1> 100~9999
 Unit:ms

Example SYST:PWM:OFF 200
 Sets the duty OFF period to 200 ms.

System Commands

*IDN → Query

Description	Returns the manufacturer, model No., serial number and system version number.	
Query Syntax	*IDN?	
Return parameter	<String>	31 characters
Example	*IDN? >GWINSTEK,GOM805,GXXXXXXXXX,V1.00.	

SYSTem:SERial → Query

Description	Returns the serial number.	
Query Syntax	SYSTem:SERial?	
Return parameter	<String>	9 characters
Example	SYST:SER? > GXXXXXXXXX	

SYSTem:BRIGhtness Set → → Query

Description	Sets or returns the brightness level.	
Syntax	SYSTem:BRIGhtness <NR1>	
Query Syntax	SYSTem:BRIGhtness?	
Parameter/ Return parameter	<NR1>	1(dim)~5(bright)
Example	SYST:BRIG 4 Turns the brightness level to 4.	

USERdefine<X>:ACTive Set → → Query

Description	Sets or returns the active output state of the selected Userdefine pin.	
-------------	---	--

Syntax	USERdefine<X>:ACTive <NR1>	
Query Syntax	USERdefine<X>:ACTive?	
Parameter/ Return parameter	<X>	Userdefine pin 1~2
	<NR1>	1:active low state 2:active high state
Example	USER1:ACT 1 Sets the userdefine1 pin IO to active low state.	

USERdefine<X>:FIRStdata

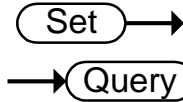

Description	Sets or returns the first operand for the selected user define pin.	
Syntax	USERdefine<X>:FIRStdata <NR1>	
Query Syntax	USERdefine<X>:FIRStdata?	
Parameter/ Return parameter	<X>	Userdefine pin 1~2
	<NR1>	1~8:bin1~bin8 state 9:bin out state 10:hi state 11:low state 12:pass state 13:fail state
Example	USER1:FIRS 12 Sets first operand of userdefine1 as pass state.	

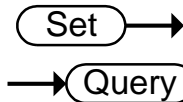

USERdefine<X>:LOGic

Description	Sets or returns operator for the selected user define pin.	
Syntax	USERdefine<X>:LOGic <NR1>	
Query Syntax	USERdefine<X>:LOGic?	
Parameter/ Return parameter	<X>	Userdefine pin 1~2
	<NR1>	1:off(only judge first data) 2:logical and. 3:logical or.
Example	USER1:LOG 1 Sets the operator of userdefine1 to off. (I.e., only the first operand determines the output of userdefine1.)	

USERdefine<X>:SEConddata

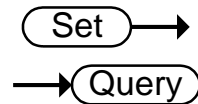

Description	Sets or returns the second operand for the selected user define pin.	
Syntax	USERdefine<X>:SEConddata <NR1>	
Query Syntax	USERdefine<X>:SEConddata?	
Parameter/ Return parameter	<X>	1~2
	<NR1>	1~8:bin1~bin8 state 9:bin out state 10:hi state 11:low state 12:pass state 13:fail state
Example	USER1:SEC 3 Sets the last operand of userdefine1 as the state of the bin3 result.	

SYSTEM:HANDler

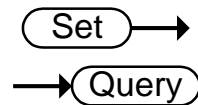

Description	Sets or returns the handler state.	
Syntax	SYSTEM:HANDler {CLEAR HOLD}	
Query Syntax	SYSTEM:HANDler?	
Parameter/ Return parameter	Clear	It clears the last result before executing measurement.
	HOLD	It holds the test result and changes when a different result appears.
Example	SYST:HAND HOLD Sets the test result to the hold state.	

SYSTEM:KEYClick:BEEPer

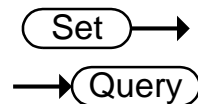

Description	Sets or returns the keyclick beeper state.	
Syntax	SYSTEM:KEYClick:BEEPer <NR1> {OFF ON}	
Query Syntax	SYSTEM:KEYClick:BEEPer?	

Parameter/ Return parameter	<NR1>	0:OFF. 1:ON.
	OFF	Turn the keyclick beeper off.
	ON	Turn the keyclick beeper on.

Example SYST:KEYC:BEEP OFF
Sets the keyclick beeper off.

Set →

→ Query

SYSTem:VOLTage:PROTect

Description	Sets or returns the HVP function state.	
Syntax	SYSTem:VOLTage:PROTect <NR1> {OFF ON}	
Query Syntax	SYSTem:VOLTage:PROTect?	
Parameter/ Return parameter	<NR1>	0: OFF. 1: ON.
	OFF	Turn the HVP function off.
	ON	Turn the HVP function on.

Example SYST:VOLT:PROT OFF
Sets the HVP function off.

SYSTem:ERRor

→ Query

Description	Returns the current system error, if any.	
Query Syntax	SYSTem:ERRor?	
Return parameter	<String>	Error number,"Error message"
Example	SYST:ERR? >0,"No error". Indicates that there is no error message.	

Error Message List 0,"No error"
 1,"Command error"
 4,"Data out of range"

SYSTem:LOCal

Set →

Description	Enables local control (front panel control) and disables remote control.
Syntax	SYSTem:LOCal
Parameter	<None>

SYSTem:VERSion

→ Query

Description	Returns the SCPI version of the device.
Query Syntax	SYSTem:VERSion?
Return parameter	<String> 10 characters
Example	SYST:VERS? >SCPI1994.0. SCPI version: 1994

Memory Commands

MEMory:SAVe

Set →

Description	Saves the settings to the selected memory slot.	
Syntax	MEMory:SAVe <NR1>	
Parameter	<NR1>	1~20
Example	MEM:SAV 1 Saves the settings to memory slot 1.	

MEMory:RECall

Set →

Description	Recalls the settings from the selected memory slot.	
Syntax	MEMory:RECall <NR1>	
Parameter	<NR1>	1~20
Example	MEM:REC 1 Recall the settings from memory slot 1.	

MEMory:CLEAr

Set →

Description	Clears the data from the selected memory slot.	
Syntax	MEMory:CLEAr <NR1>	
Parameter	<NR1>	1~20
Example	MEM:CLE 1 Clear data from memory slot 1.	

MEMory:STATe

→ Query

Description	Returns the status of all the memory slots.	
Query Syntax	MEMory:STATe?	
Return parameter	<String>	23 Characters composed of “N” or “F”, where “N” indicates “Not used” and “F” indicates “Full”.

Example

MEM:STAT?

> NFFNN-NNNNN-NNNNN-NNNNN

Indicates that memory slots 2 and 3 have data and that all other memory slots are empty.

Status Commands

STATus:PRESet

Set →

Description	Sets the QUESTionable enable register to zero.
Syntax	STATus:PRESet <NONE>
Parameter	<None>

STATus:QUESTionable:ENABLE

Set →
→ Query

Description	Sets or returns the Questionable Data Enable register.
Syntax	STATus:QUESTionable:ENABLE <NR1>
Query Syntax	STATus:QUESTionable:ENABLE?
Parameter/ Return parameter	<NR1> 0~32767.
Example	STAT:QUES:ENAB 2560 Sets the Questionable Data Enable register to 000101000000000.

STATus:QUESTionable:EVENT

→ Query

Description	Returns the contents of the Questionable Data Event register.
Query Syntax	STATus:QUESTionable:EVENT?
Return parameter	<NR1> 0~32767
Example	STAT:QUES:EVENT? >512 512 indicates that the Questionable Data Event register=0000001000000000.

IEEE 488.2 Common Commands

*CLS



Description Clears the Event Status register (Output Queue, Operation Event Status, Questionable Event Status, Standard Event Status).

Syntax *CLS

Parameter <None>

*ESE



Description Sets or returns the ESER (Event Status Enable Register) contents.

Syntax *ESE <NR1>

Query Syntax *ESE?

**Parameter/
Return parameter** <NR1> 0~255

Example *ESE 65
Sets the ESER to 01000001
*ESE?
>130
ESER=10000010

*ESR



Description Returns SESR (Standard Event Status Register) contents.

Syntax *ESR?

Query Syntax

Return parameter <NR1> 0~255

Example *ESR?
>198
SESR=11000110

***OPC**

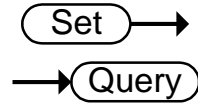

Description	Sets or returns the operation complete bit (bit0) in SERS (Standard Event Status Register) when all pending operations are completed.	
Syntax	*OPC	
Query Syntax	*OPC?	
Parameter	<None>	
Return parameter	<NR1>	0:operation not complete 1:operation complete
Example	*OPC? Returns 1.	

***RST**



Description	Recalls default panel setup.	
Syntax	*RST	
Parameter	<None>	

***SRE**

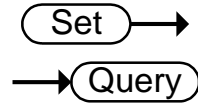

Description	Sets or returns the SRER (Service Request Enable Register) contents.	
Syntax	*SRE <NR1>	
Query Syntax	*SRE?	
Parameter/ Return parameter	<NR1>	0~255
Example	*SRE 7 Sets the SRER to 00000111 *SRE? >3 SRER=00000011	

***STB**

→ Query

Description	Returns the SBR (Status Byte Register) contents.
-------------	--

Query Syntax	*STB?
--------------	-------

Return parameter	<NR1>	0~255
------------------	-------	-------

Example	*STB? >81 SESR=01010001
---------	-------------------------------

***TRG**

Set →

Description	Manually triggers the instrument.
-------------	-----------------------------------

Syntax	*TRG
--------	------

Parameter	<None>
-----------	--------

Status system

The diagram below is a description of the status system.

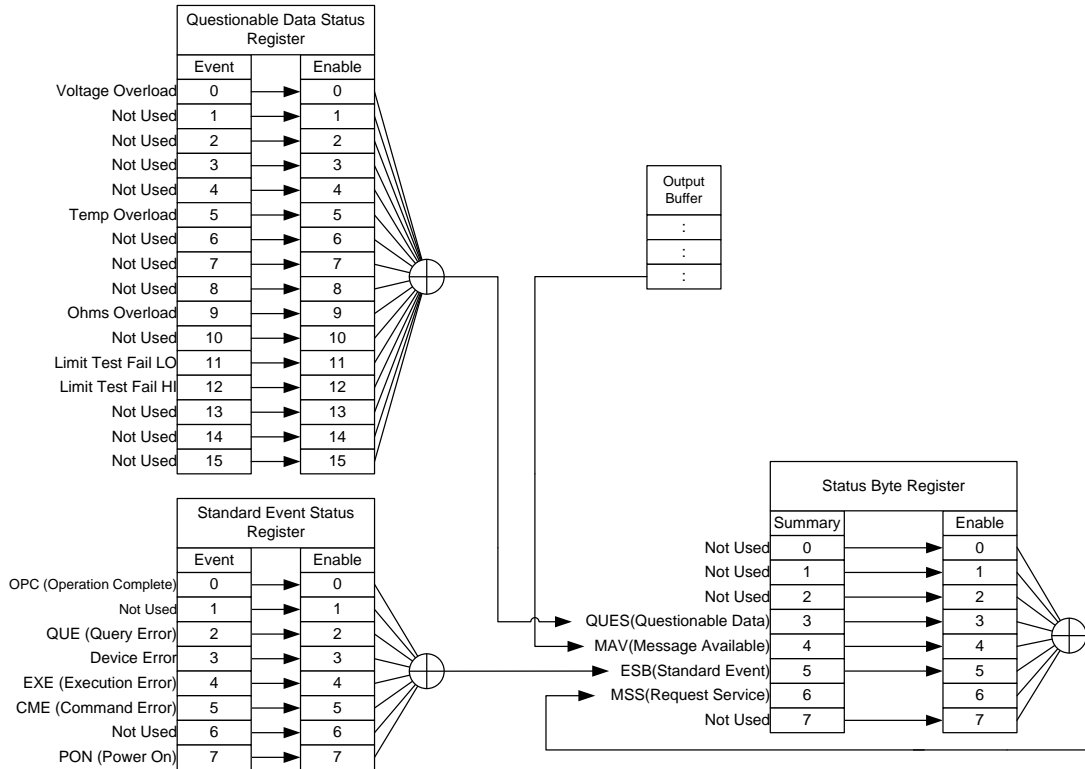

For the following command sets, please refer to the diagram above:

- STAT: QUES: EVEN?
- STAT: QUES: ENAB
- STAT: QUES: ENAB?
- *ESR?
- *ESE
- *ESE?
- *STB?
- *SRE
- *SRE?

FAQ

- What are the different measurement speeds?
- The GOM-804/805 performance does not match the specifications.

What are the different measurement speeds?

There are two measurement speeds for both resistance and temperature measurement. At the slow measurement rate, the measurement speed is 10 samples/s and at the fast measurement rate the measurement speed is at 60 samples/s.

The GOM-804/805 performance does not match the specifications.

Make sure the device is powered on for at least 30 minutes, is operated at the slow measurement rate and is within +18°C~+28°C with a humidity not exceeding 80%. This is necessary to stabilize the unit to match the specifications.

If there is still a problem, please contact your local dealer or GWInstek at marketing@goodwill.com.tw.

APPENDIX

Function Combinations	Function Selection Combinations	151
Temperature Measurement	Reference Temperature Table	152
	RTD Sensors	153
	Optional Platinum Sensor.....	153
Specifications	Resistance Measurement	155
	Dry Resistance Measurement	156
	Temperature Measurement	156
	Temperature Correction Function	156
	Interface.....	157
	Environmental	157
	General	157
	Dimensions	158
CE Declaration	Declaration of Conformity.....	159

Function Selection Combinations

Function Combination Table

Overview The following table shows which functions can be used with the Relative, Drive and Dry Circuit functions.

Function	Rel	Dry(*1)	Drive(*2)
Ohm	✓	✓	✓
Comp	✓	✓	✓
Bin	✓	✓	✓
TC	✓	✓	✓
Tconv	✓	✓	✓
Temp	✓	✓	✓
Scan	✗	✗	✗
Diode	✗	✗	✗

*1. When the Dry Circuit measurement function is turned on, only the DC+, DC- and Pulse signals can be selected. Please refer to page 37 for limitations on the range selection when using the Dry Circuit measurement function.

*2. The “Zero” drive setting is only available for the Ohm measurement function.

Temperature Measurement

Reference Temperature Table

Overview The International Temperature Scale (ITS) is based on the
Background following table. The table has 17 fixed calibration points as
of 1990.

Element		Type	Temperature	
			°K	°C
(H ₂)	Hydrogen	Triple point	13.8033	-259.3467
(Ne)	Neon	Triple point	24.5561	248.5939
(O ₂)	Oxygen	Triple point	54.3584	218.7916
(Ar)	Argon	Triple point	83.8058	-189.3442
(Hg)	Mercury	Triple point	234.325	-38.8344
(H ₂ O)	Water	Triple point	273.16	+0.01
(Ga)	Gallium	Melting point	302.9146	29.7646
(In)	Indium	Freezing point	429.7485	156.5985
(Sn)	Tin	Freezing point	505.078	231.928
(Zn)	Zinc	Freezing point	692.677	419.527
(Al)	Aluminum	Freezing point	933.473	660.323
(Ag)	Silver	Freezing point	1234.93	961.78
(Au)	Gold	Freezing point	1337.33	1064.18

RTD Sensors

Overview Resistive Thermal Devices (RTDs) are commonly used as temperature sensors. RTDs change resistance linearly over a specific range of temperature. The table below shows some of the inherent features of RTDs compared to thermocouples.

Feature	Description
Accuracy	Higher accuracy
Resolution	0.1~1.0°C, higher resolution
Speed of response	Slower
Self-heating	Yes
Long term stability	Good
Output characteristics	Approx. 0.4ohm/°C, near linear

Optional Platinum Sensor

Introduction The optional platinum sensor is a PT-100 sensor. The PT-100 sensor meets the German DIN43760: 1968 3 wire measurement specification.

These sensors are one of the most common temperature sensors used in industry. These sensors have a nominal resistance of 100Ω at 0°C.

The relationship between temperature and resistance for the PT-100 sensor can be described with the Gallendarvan Dusen equation shown below:

$$R_{RTD} = R_0 [1 + AT + BT^2 + CT^3 (T - 100)]$$

Where: R_{RTD} is the calculated resistance of the RTD.

R_0 is the known RTD resistance at 0°C.

T is the temperature in °C

$A = \alpha [1 + (\delta/100)]$

$B = -1(\alpha)(\delta)(1e-4)$

$C = -1(\alpha)(\beta)(1e-8)$

The Alpha (A), Beta (B), Delta (D) values for the

PT-100 sensor are listed below:

Type	Standard	Alpha	Beta	Delta	$\Omega @ 0^\circ\text{C}$
PT-100	ITS90	0.003850	0.10863	1.49990	100 Ω

Temperature
Calculation Example

Example—Calculating the resistance of a PT-100 RTD at 100°C (T). The following R_0 (Ω at 0°C), alpha, beta, and delta values are used for the PT-100 RTD:

$$T=100^\circ\text{C}$$

$$R_0 (\Omega \text{ at } 0^\circ\text{C}) = 100\Omega$$

$$\text{Alpha}=0.003850$$

$$\text{Beta}=0.10863$$

$$\text{Delta}=1.49990$$

A, B, and C are calculated according to equations listed above:

$$A=0.00391$$

$$B=5.77e-7$$

$$C=4.18e-12$$

The resistance of the RTD at 100°C (R_{100}) is then calculated as follows:

$$\begin{aligned} R_{100}: &= R_0[1+AT+BT^2+CT^3(T-100)] \\ &= 100\{1+[(0.00391)(100)]+[-5.77e-7)(100^2) \\ &\quad + [(-4.18E-12)(100^3)(100-100)]\} \\ &= 138.5\Omega \end{aligned}$$

Specifications

Conditions Background

The specifications are applicable under the following conditions:

- A 1-year calibration cycle.
- An operating temperature of 18 to 28 °C (64.4 to 82.4°F).
- Relative humidity not exceeding 80%.
- Accuracy is expressed as \pm (percentage of reading + percentage of range).
- The instrument requires 30 minutes warm-up time and must be operated at the slow measurement rate to achieve rated accuracy.
- The power cord protective grounding conductor must be connected to ground.

Resistance Measurement

50000 counts

Range	Resolution	Measuring Current	Accuracy	Open-Terminal Voltage
5m Ω	0.1 $\mu\Omega$	1A	$\pm(0.1\%+0.2\%)$	~6.25V
50m Ω	1 $\mu\Omega$	1A	$\pm(0.1\%+0.02\%)$	~6.25V
500m Ω	10 $\mu\Omega$	100mA	$\pm(0.05\%+0.02\%)$	~6.25V
5 Ω	100 $\mu\Omega$	100mA	$\pm(0.05\%+0.02\%)$	~6.25V
50 Ω	1m Ω	10mA	$\pm(0.05\%+0.02\%)$	~6.25V
500 Ω	10m Ω	1mA	$\pm(0.05\%+0.008\%)$	~6.25V
5k Ω	100m Ω	100 μ A	$\pm(0.05\%+0.008\%)$	~6.25V
50k Ω	1 Ω	100 μ A	$\pm(0.05\%+0.008\%)$	~6.25V
500k Ω	10 Ω	10 μ A	$\pm(0.05\%+0.008\%)$	~6.25V
GOM-805 Only				
5M Ω	100 Ω	1 μ A	$\pm(0.5\%+0.008\%)$	~6.25V
GOM-804 Only				
5M Ω	100 Ω	1 μ A	$\pm(0.2\%+0.008\%)$	~6.25V

*When use 5m Ω range, in order to obtain a stable value, it is recommended to use 10 times average and fixed connection method such as lock.

*When the instrument is set to 5m Ω or 50m Ω or 500m Ω ranges, the resistance value will be changed while connecting or disconnecting the test

lead to the panel due to the different temperature between internal and external parts of the instrument. Therefore, please wait 1 minute in order to obtain an accurate value after the test leads have been connected or disconnected.

* When Kelvin clips are used to resume testing after a long period of time, please wait for a short time to stabilize the measurement.

*Fast and Slow measurement rates have the same specifications. However, the Slow rate is more accurate as it will correct for any errors associated with temperature drift that occurs from the difference between the measurement temperature and the calibration temperature.

Measurement	Four-terminal method.
Auto-ranging	Provided.
Over input range	“-----” indicates over range
Maximum Applied voltage*	5m~5Ω range: 30VpDC Other range: 100VpDC
Comparator	20 sets of comparator status can be selected.
Buzzer mode	OFF, PASS, FAIL
switchable	

*Only when HVP (High Voltage Protect) function is enabled, can Maximum Applied voltage be available. Refer to page 77 for details.

Dry Resistance Measurement

Range	Measuring Current	Accuracy
500mΩ	100mA	±(0.3%+0.05%)
5Ω	10mA	±(0.3%+0.05%)
50Ω	1mA	±(0.3%+0.05%)

Temperature Measurement

Temperature sensor (option)	Platinum resistor. Lead length: 1.5m approx.
-10°C ~40°C	0.3%±0.5°C
Other	0.3%±1.0°C

Temperature Correction Function

Reference temperature range	-50.0°C~399.9°C
Thermal coefficient range	±9999 ppm
Temperature range	Accuracy of temperature compensation for 3930 ppm/Cu wire.*
-10°C~40.0°C	0.3%+resistance measurement accuracy.

Other	0.6%+resistance measurement accuracy.
-------	---------------------------------------

*The temperature coefficient for the other settings must be calculated individually according to different conditions.

*If the temperature coefficient or the difference between the environmental temperature and the required temperature exceeds normal operation, after calculating the compensation, the variation to the reading value will be significant.

*When using the PT-100 temperature sensor for temperature measurements, the accuracy of the sensor (typical accuracy of $\leq \pm 0.5^{\circ}\text{C}$) should also be taken into account and calculated for.

Interface

Handler interface*	Signal: Trigger: TTL input Signal: LOW, HIGH, FAIL, PASS, EOT, READY, BIN 1~8, BIN OUT: total 15 TTL outputs.
Scan*	Signal: RELAY, PASS, LOW, HIGH, CLOCK, STRB total 6 TTL outputs.
Communication Interfaces	GOM-804: USB/RS-232 GOM-804G: USB/RS-232/GPIB GOM-805: USB/RS-232/GPIB *The Scan and Handler interface use the same connector.

Environmental

Operation Environment	Indoor use, altitude up to 2000m. Operation Environment: 0°C to 40°C . Temperature Range: $0 \sim 35^{\circ}\text{C}$, Relative Humidity: $<80\%RH$; $>35^{\circ}\text{C}$, Relative Humidity: $<70\%RH$. Pollution Degree 2
Storage Conditions	-10°C to 70°C . Temperature Range: $0 \sim 35^{\circ}\text{C}$, Relative Humidity: $<90\%RH$; $>35^{\circ}\text{C}$, Relative Humidity: $<80\%RH$

General

Power source	AC 100-240V \pm 10%, 50-60Hz, 25VA
Accessories	Power cord x1 Test lead: GTL-308 x1 User manual x1 (CD) Safety instruction sheet x1 USB cable (option): GTL-246 Temperature sensor (option): PT-100
Dimension	223(W) \times 102(H) \times 283(D) mm
Weigh	Approx. 3 kg

Dimensions

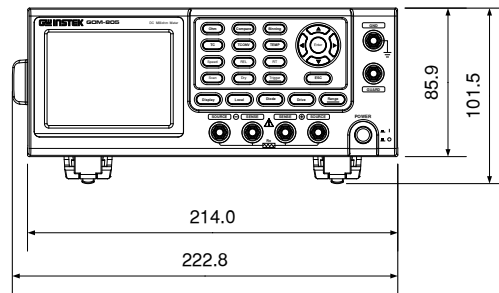
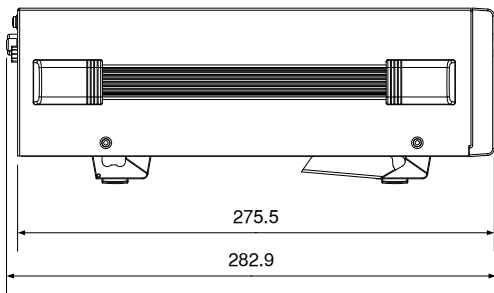
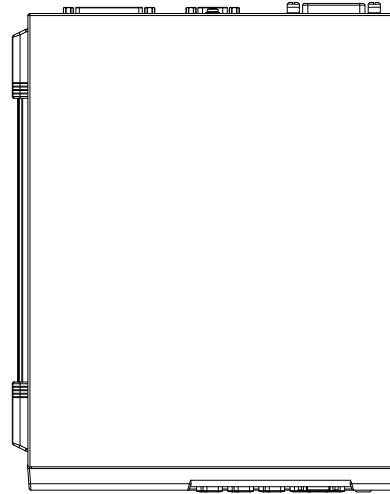

Declaration of Conformity

We
GOOD WILL INSTRUMENT CO., LTD.
 declare, that the below mentioned product
 Type of Product: **DC Milliohm Meter**
 Model Number: **GOM-804, GOM-805**
 satisfies all the technical relations application to the product within the scope
 of council:
Directive: 2014/30/EU; 2014/35/EU; 2011/65/EU; 2012/19/EU
 The above product is in conformity with the following standards or other
 normative documents:

⊙ EMC

EN 61326-1	Electrical equipment for measurement, control and laboratory use -- EMC requirements (2013)
EN 61326-2-1	
Conducted and Radiated Emission EN 55011: 2009+A1:2010	Electrical Fast Transients EN 61000-4-4: 2012
Current Harmonics EN 61000-3-2: 2014	Surge Immunity EN 61000-4-5: 2006
Voltage Fluctuation EN 61000-3-3: 2013	Conducted Susceptibility EN 61000-4-6: 2014
Electrostatic Discharge EN 61000-4-2: 2009	Power Frequency Magnetic Field EN 61000-4-8: 2010
Radiated Immunity EN 61000-4-3: 2006+A1: 2008+A2: 2010	Voltage Dip/ Interruption EN 61000-4-11: 2004

⊙ Safety

Low Voltage Equipment Directive 2014/35/EU	
Safety Requirements	EN 61010-1: 2010 EN 61010-2-030: 2010

GOOD WILL INSTRUMENT CO., LTD.

No. 7-1, Jhongsing Road, Tucheng Dist., New Taipei City 236, Taiwan

Tel: +886-2-2268-0389

Fax: +866-2-2268-0639

Web: www.gwinstek.com

Email: marketing@goodwill.com.tw

GOOD WILL INSTRUMENT (SUZHOU) CO., LTD.

No. 521, Zhujiang Road, Snd, Suzhou Jiangsu 215011, China

Tel: +86-512-6661-7177

Fax: +86-512-6661-7277

Web: www.instek.com.cn

Email: marketing@instek.com.cn

GOOD WILL INSTRUMENT EURO B.V.

De Run 5427A, 5504DG Veldhoven, The Netherlands

Tel: +31(0)40-2557790

Fax: +31(0)40-2541194

Email: sales@gw-instek.eu

INDEX

Binning function	
setting	46
Characteristics	10
Compare function	
setting	41
Declaration of conformity	159
Dimensions	158
Diode	40
Display mode	35
Disposal instructions	7
Drive overview	31
Drive setting	33
function combinations	151
Dry circuit	37
function combinations	151
EN 61010	
measurement category	6
pollution degree	7
Environment	
operation	6
storage	7
External IO	73
FAQ	149
Front panel overview	15
Function selection combinations	151
Getting Started chapter	9
Handler	
compatibility	90
overview	79
pinout	81
Handler mode	74
Interface	
GPIB	
function check	97
setting	94
overview	91
RS232	
function check	94
Realterm example	95
setting	93
USB	
driver	92
function check	94
Realterm example	95
setting	91
Measurement settings	
ambient temperature	66
average	60
line frequency	67
measure delay	61
PWM duty	68
setting	60
temperature unit	65
trigger delay	63
trigger edge	64
Power supply safety instructions	6
Power up	24
PT-100 sensor temperature calculation	153
PWM duty	68
Range	30
Rate	
setting	34
Real time display	36
Rear panel overview	21
Recall settings	100
Reference temperature table	152
Relative function	
connection	26
function combinations	151
Remote control	
binning commands 109, 113, 118, 127, 131, 132, 137, 142	
Command list	106
command syntax	103
common commands	145
status commands	144
temperature commands	126
Resistance	
range	30
setting	29, 40
Resistance measurement	
connection	25
RT display	36
Safety instruction	
Guidelines	6
Safety instructions	
power supply	6
symbol	5
Save settings	100
Scan	
GOM-802 compatibility	90
output	89
overview	83
pinout	84
setup	85
Service contact	149
Specifications	155
Status system	148

System settings		
beep	76, 77	
brightness.....	72	
external IO	73	
handler mode	74	
interface.....	71	
power on settings.....	70	
system information.....	69	
Table of contents	3	
Temperature		
setting	50	
Temperature compensation		
setting	52	
Temperature conversion		
setting.....	56	
Temperature measurement		
reference.....	152	
TFT-LCD overview	19	
Tilt stand	23	
Trigger		
setting.....	38	
United Kingdom power cord	8	
Zeroing		
connection.....	26	