

# Blade Fuse Block w/ LED Warning Light 6 Position

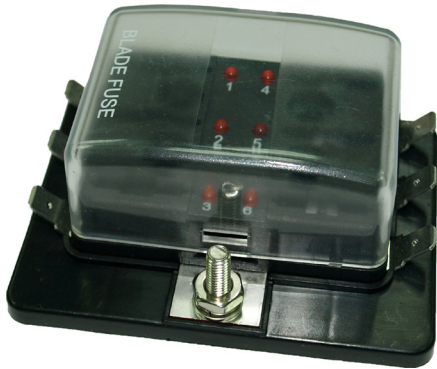

## Specifications

Fuse Holder Type	: Blade Fuse Holder
Fuse Holder Terminal	: Quick Connect
Fuse Size	: Blade
No. of Fuses	: 6 Fuses
Input Terminal Rating	: #10-32 Threaded Studs (100A Max.)
Output Terminal Rating	: 30A Max. Per Circuit
Voltage Rating	: 32V DC
Connection Pad	: Input Wire Size: #4-6AWG Output Wire Size: #12-16AWG
Torque Rating	: 20 in-lb (2.25Nm) Max.
Mounting Torque Rating	: 8 in-lb (0.9Nm) Max.
Operating Temperature	: -20°C to +85°C

## Material Specifications

Housing & Base	: PBT, UL94V-0, Black
Cover	: PC, UL94V-2, Transparent
Push Button	: POM, White
Terminal	: Copper, Tin Plated

## Diagram

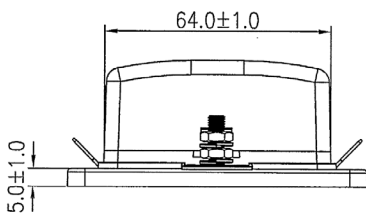
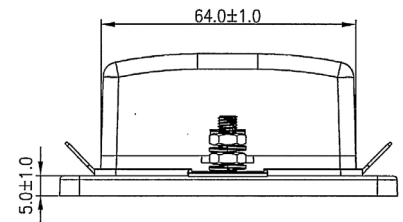
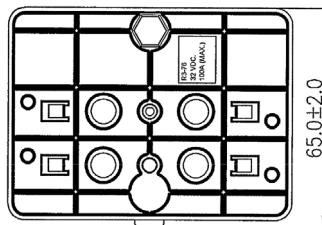
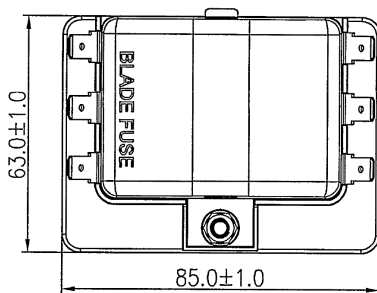

### Blade Fuse Dim.

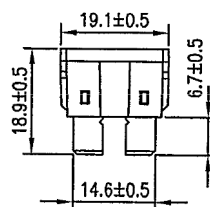

### Mounting Holes

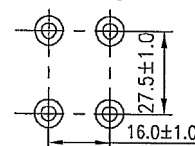

### Terminal Dim.

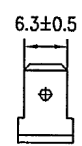

Dimensions : Millimetres

Newark.com/multicomp-pro  
Farnell.com/multicomp-pro  
Element14.com/multicomp-pro



# Blade Fuse Block w/ LED Warning Light 6 Position



**Circuit Diagram**

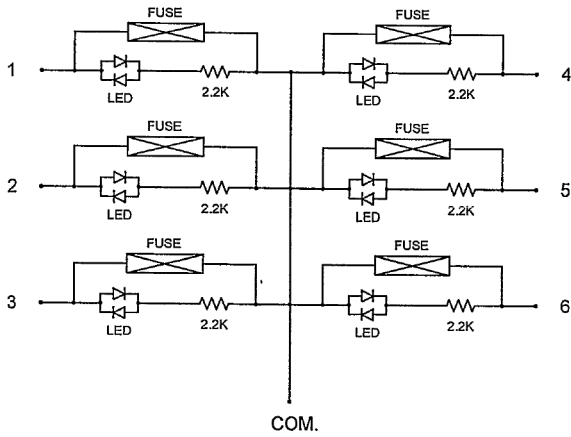

**Part Number Table**

Description	Part Number
Blade Fuse Block w/ LED Warning Light, 6 Position, Panel Mount, QC	MC002800

**Important Notice :** This data sheet and its contents (the "Information") belong to the members of the AVNET group of companies (the "Group") or are licensed to it. No licence is granted for the use of it other than for information purposes in connection with the products to which it relates. No licence of any intellectual property rights is granted. The Information is subject to change without notice and replaces all data sheets previously supplied. The Information supplied is believed to be accurate but the Group assumes no responsibility for its accuracy or completeness, any error in or omission from it or for any use made of it. Users of this data sheet should check for themselves the Information and the suitability of the products for their purpose and not make any assumptions based on information included or omitted. Liability for loss or damage resulting from any reliance on the Information or use of it (including liability resulting from negligence or where the Group was aware of the possibility of such loss or damage arising) is excluded. This will not operate to limit or restrict the Group's liability for death or personal injury resulting from its negligence. Multicomp Pro is the registered trademark of Premier Farnell Limited 2019.

Newark.com/multicomp-pro  
Farnell.com/multicomp-pro  
Element14.com/multicomp-pro

