

**PRODUCT NUMBER: 3305-2-15-80-47-27-10-0**

**3305-X-XX-XX-47-XX-10-0**

Solder mount in .060 [1,52] min. mounting hole

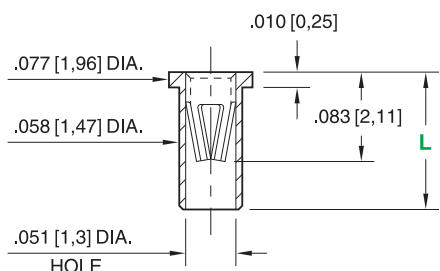

Basic Part Number	Length (L)
3305-0-15	.105 [2,67]
3305-1-15	.130 [3,30]
3305-2-15	.155 [3,94]

Units: inch [mm]  
 Standard Tolerances:  
 Lengths: ±.005 [0,13]  
 Diameters: ±.002 [0,051]  
 Angles: ± 2°

**3305-2-57 Tape & Reel Details**

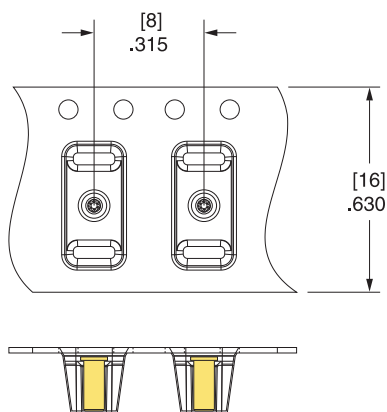

**DESCRIPTION**

Receptacle With No Tail

**Durability:**

1,000 Cycles Minimum

**Current Rating:**

4.5A @ 10°C Temperature Rise

**Contact Resistance:**

10 mΩ Max

**Operating Temperature Range:**

-55/+125° C

**Vibration:**

No Elect. Discontinuity > 1μs @ 10-2000HZ, 20 G

**Shock:**

No Elect. Discontinuity > 1μs @ 50g

Accepts .025"-.037" (0,635-0,940mm) diameter leads.

**Mounting Feature:**

Solder Mount

**Tail Type:** None

**Mounting Hole:** .060" (1,524mm)

**Packaging:** 15 - Packaged in Bulk

<b>Shell Plating</b>	<b>Contact Plating</b>	<b>ROHS</b>
----------------------	------------------------	-------------

200 - 300 μ" Tin (matte finish) over Nickel

30 μ" Gold over Nickel



**CONTACT:**

# #47 CONTACT

FOR .025"-.037" DIA. & .025" SQ. ( $\delta = .011$ )  
6-FINGER (BeCu), GROUP D

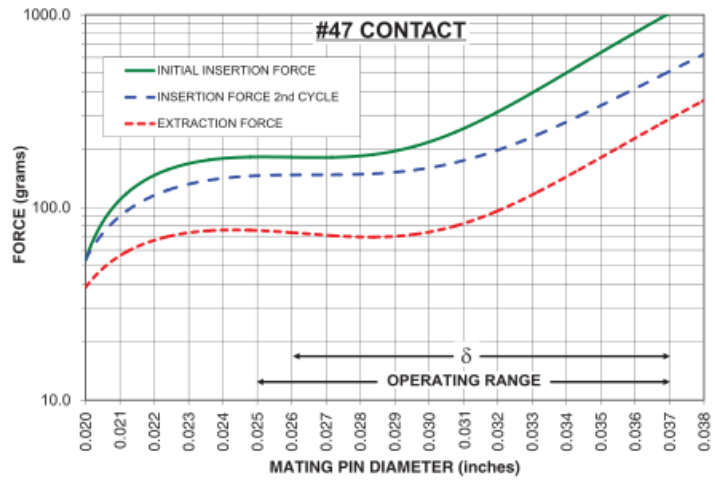
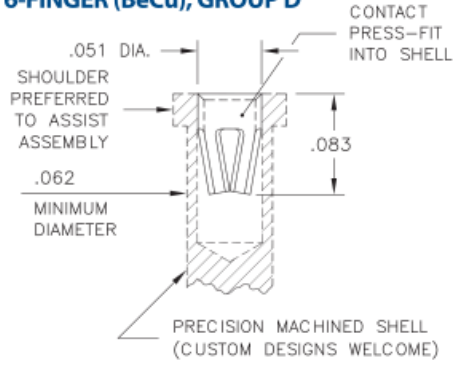

The insertion / extraction force characteristics above were derived using a 30 microinch gold-plated contact and polished steel gauge pins having a bullet-shaped tip. The curves represent typical average values; they are best used to compare the differences between similar size contacts and to guide you in selecting one that is suitable for your application. Your results may vary, so for your specification, we encourage you to obtain complimentary samples for your evaluation.

<b>Pin Diameter Range</b>	.025"-.037" (0,635-0,940mm)		
<b>Material</b>	Beryllium Copper	<b>Current Rating (amps)</b>	4.50
<b>Fingers</b>	6	<b>Compliance</b>	.011" (0,279mm)
<b>Length</b>	.080" (2,032mm)	<b>Group Code</b>	D

## CONTACT MATERIAL:

## BERYLLIUM COPPER ALLOY 172 (UNS C17200) per ASTM B 194

Properties of BERYLLIUM COPPER:

- Chemical composition: Cu 98.1%, Be 1.9%
- Hardness: 36-43 Rockwell C
- Density: .298 lbs/in<sup>3</sup>
- Electrical Conductivity: 22% IACS\*
- Resistance: 10 mΩ Max
- Operating Temperature: -55°C/+125°C
- Melting point: 980°C/865°C (liquidus/solidus)
- Stress Relaxation†: 96% of stress remains after 1,000 hours @ 100 °C; 70% of stress remains after 1,000 hours @ 200 °C

\*International Annealed Copper Standard, i.e. as a % of pure copper.

†Since BeCu loses its spring properties over time at high temperatures; it is rated for continuous use up to 150°C. For applications up to 300°C, Mill-Max offers other materials. [Contact Tech Support](#) for more info.

## STANDARD TOLERANCES ON PCB TERMINAL PINS & RECEPTACLES

Diameters +/- .002"  
Lengths +/- .005"  
Angles +/- 2°

## STANDARD TOLERANCES ON SPRING-LOADED PINS

Diameters +/- .002"  
Lengths +/- .006"  
Angles +/- 2°

## ADDITIONAL NOTES & SPECIFICATIONS

In the interest of improved design, quality and performance, Mill-Max reserves the right to make changes in its specifications without prior notice. Specifications and tolerances are provided wherever possible. The tolerance on dimensions of critical to function features is typically held tighter than the stated standard tolerances, such as press-fits, holes and lengths affecting the coplanarity of SMT products. Due to the

wide variety of interconnects Mill-Max offers, the specific tolerances vary from product to product. If you need information regarding the tolerance of a particular part, please contact Technical Services.

---

 © 2021 Mill-Max Mfg. Corp.  
190 Pine Hollow Rd , Oyster Bay, NY 11771, USA  
Phone: 516.922.6000