

Product datasheet

P DIM PAR16 3.7 W/927 GU10

PARATHOM DIM PAR 16 | Dimmable LED reflector lamps PAR16 with retrofit pin base



- Shops and exhibition rooms Domestic applications
Commercial applications Accent lighting Outdoor use in
outdoor luminaires only (minimum IP65)

- Quick, simple and safe replacement without rewiring Design, dimensions, luminous flux comparable to an incandescent or halogen lamp Low maintenance costs thanks to long lifetime No UV and near-IR radiation in the light beam Stepless dimming Very high dimmer compatibility, see also "www.ledvance.com/dim" Instant 100 % light, no warm-up time



Technical data

Electrical data

Rated wattage	3.70 W
Nominal wattage	3.70 W
Nominal voltage	220...240 V
Claimed equiv. conventional lamp power	35 W
Operating frequency	50...60 Hz
Max. lamp no. on circuit break. 10 A (B)	237
Max. lamp no. on circuit break. 16 A (B)	379
Nominal current	0.017 A

Photometrical data

Nominal luminous flux	230 lm
Rated luminous flux	230 lm
Rated color temperature	2700 K
Color rendering index Ra	≥90
Light color (designation)	Warm White
Standard deviation of color matching	≤5 sdcn
Nominal useful luminous flux 90°	230 lm
Rated useful luminous flux 90°	230 lm
Rated peak intensity	630 cd
Color temperature	2700 K
Luminous flux	230 lm
Lumen main.fact.at end of nom.life time	0.70

Light technical data

Beam angle	36 °
Nominal beam angle	36 °
Rated beam angle (half peak value)	36.00 °
Starting time	< 0.5 s

Dimensions & weight

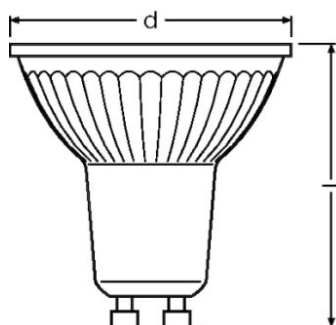

Overall length	55.0 mm
Diameter	51.0 mm
Outer bulb	PAR51
Product weight	48.00 g
Length	55.0 mm
Maximum diameter	51.0 mm

Temperatures & operating conditions

Ambient temperature range	-20...+40 °C
---------------------------	--------------

Lifespan

Nominal lamp life time	25000 h
Rated lamp life time	25000 h
Number of switching cycles	100000
Lumen maintenance at end of service life	0.70

Additional product data

Base (standard designation)	GU10
Mercury content	0.0 mg
Mercury-free	Yes
Appropriate disposal acc. to WEEE	Yes
Product remark	All technical parameters apply to the entire lamp/Due to the complex production process for light-emitting diodes, the typical values shown for the technical LED parameters are purely statistical values that do not necessarily match the actual technical parameters of each individual product, which can vary from the typical value

Product datasheet

Capabilities

Dimmable	Yes
----------	-----

Certificates & standards

Energy efficiency class	A+
Energy consumption	4 kWh/1000h
Type of protection	IP20

Country specific categorizations

Order reference	LPPAR16D3536 3,
-----------------	-----------------

Logistical Data

Product code	Product description	Packaging unit (Pieces/Unit)	Dimensions (length x width x height)	Volume	Gross weight
4058075259973	P DIM PAR16 3.7 W/927 GU10	Shipping carton box 10 Pieces Folding carton box	257 mm x 110 mm x 70 mm	1.98 dm ³	598.00 g

The mentioned product code describes the smallest quantity unit which can be ordered. One shipping unit can contain one or more single products. When placing an order, for the quantity please enter single or multiples of a shipping unit.

References / Links

For dimming conformity see

- ▶ www.osram.com/DIM

For further products and actual information concerning LED lamps see

- ▶ www.osram.com/ledlamps

For Guarantee see

- ▶ www.osram.com/guarantee

Disclaimer

Subject to change without notice. Errors and omission excepted. Always make sure to use the most recent release.

OSRAM is distribution partner
of LEDVANCE of LAMPS

OSRAM

OSRAM GmbH
Marcel-Breuer-Strasse 6
80807 Munich, Germany