

QTP-T/E 1X26...42,2X26

QUICKTRONIC PROFESSIONAL M | ECG for CFL



Product family features

- Supply voltage: 220...240 V
- Line voltage: 198...264 V
- Line frequency: 0 Hz | 50 Hz | 60 Hz
- Lamp start with optimum filament preheating
- Energy Efficiency Index EEI: A2
- Automatic shutdown of defective lamps and at end of life (EoL T.2)
- Lamp operation: to EN 60929
- Safety: to EN 61347-2-3

Product family benefits

- Long lamp life
- No adverse effect from frequent on/off switching
- Automatic restart after lamp replacement
- Perfect lamp start for applications with motion sensors
- Separate installations thanks to optional cable clamp for K2 and K3 casings
- VDE/VDE EMC certified system

Areas of application

- Emergency lighting systems acc. to EN 50172 / DIN VDE 0108-100
- Public buildings
- Sports halls and factories
- Suitable for luminaires of protection class I

Product datasheet

Technical data

Electrical data

Input voltage AC	198...264 V
Nominal voltage	220...240 V
Mains frequency	50...60 Hz
Input voltage DC	176...276 V
Operating frequency	40...50 kHz
Max. ECG no. on circuit breaker 10 A (B)	17 ¹⁾
Max. ECG no. on circuit breaker 16 A (B)	28 ¹⁾

¹⁾ Type B

Light technical data

Starting time	1.0 s
---------------	-------

Dimensions & weight

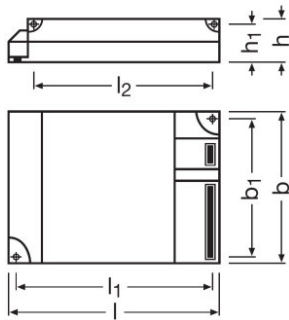

Length	103.0 mm
Width	67.0 mm
Height	31.0 mm
Mounting hole spacing, length	94.0 mm
Mounting hole spacing, width	57.0 mm
Product weight	148.50 g
Cable cross-section, output side	0.5...1.5 mm ²
Cable cross-section, input side	0.5...1.5 mm ²

Temperatures & operating conditions

Ambient temperature range	-20...+50 °C
Permitted rel. humidity during operation	5...85 % ¹⁾

¹⁾ Maximum 56 days/year at 85 %

Product datasheet

Lifespan

ECG lifetime	50000 h ¹⁾
---------------------	-----------------------

¹⁾ At $T_{case} = 75^{\circ}\text{C}$ at T_{point} / 10% failure rate

Expected Lifetime

Product name	Lamp group				
QTP-T/E 1X26...42,2X26	DULUX T/E 26 W	ECG ambient temperature [ta]	40	50	60
		Temperature at tc-point [°C]	55	65	70
		Lifetime [h]	100000	100000	60000
	DULUX D/E 26 W	ECG ambient temperature [ta]	40	50	60
		Temperature at tc-point [°C]	55	65	70
		Lifetime [h]	100000	100000	60000
	DULUX T/E 42 W	ECG ambient temperature [ta]	40	50	60
		Temperature at tc-point [°C]	55	65	70
		Lifetime [h]	100000	100000	60000

Additional product data

Product remark	Optional cable clamp, see chapter ECG mountings - cable clamp
Suitable for lamp power (1 lamp)	26...42 W
Suitable for lamp power (2 lamps)	26 W

Capabilities

Suitable for fixtures with prot. class	I / II
End of lamp life safety shutdown	EOL T.2
Max. cable length to lamp/LED module	2.0 m / 1.0 m
Dimmable	No

Certificates & standards

Approval marks – approval	VDE / ENEC 10 / VDE-EMC / GOST / RCM
EEI – Energy Label	A2 BAT
Standards	Acc. to EN 61347-2-3/Acc. to EN 60929/Acc. to EN 55015:2006 + A1:2007/Acc. to EN 61000-3-2/Acc. to EN 61547
Protection class	III
Type of protection	IP20

Logistical data

Commodity code	850410809000
----------------	--------------

Wiring Diagram

QUICKTRONIC® QTP-D/E + QTP-T/E

	QTP-D/E 1X19,26	QTP-D/E 2X19,26	QTP-T/E 1X26,26	QTP-T/E 2X26,26
Box size	26 x 19,26	26 x 38,52	26 x 26	26 x 52
Max. load	100 W	100 W	100 W	100 W
Max. current	0,7 A	0,7 A	0,7 A	0,7 A
T _{th}	100 µm	200 µm	200 µm	200 µm

Max. permitted cable length in between E13 and base: 2,0 m (QTP-D/E, 1X) + 3,0 m (QTP-D/E, 2X)
Max. permitted cable length in between E13 and base: 2,0 m (QTP-T/E, 1X) + 3,0 m (QTP-T/E, 2X)

Max. Leistungslänge zwischen E13 und Lampe, Leiterplattegröße: 200 µm
Max. Leistungslänge zwischen E13 und Lampe, Leiterplattegröße: 200 µm
Eigenschaften sind ohne Gewährleistung zu verwenden, wenn nicht anders angegeben.

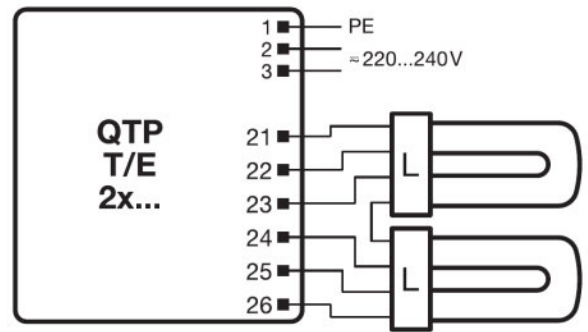

596657_EAC QTP-DE + QTP-TE



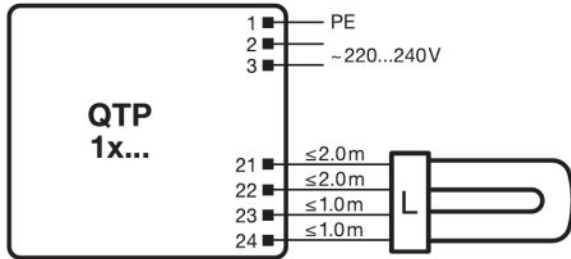

723139_Wiring Diagram QTP-TE 2x

Product datasheet



723146_Wiring diagram QTP 1x

Download Data

File
 Certificates 334954_ENEC-Marks approval
 Certificates 334956_EMC-Marks approval – QTP-M
 Certificates 335169_Manufacturer's declaration – LampECG combinations: Frequent switching
 Certificates 504181_VDE-EMC-Certificate QTP DL_TE
 Declarations of conformity Quicktronic CE 3364256 090421

Logistical Data

Product code	Product description	Packaging unit (Pieces/Unit)	Dimensions (length x width x height)	Volume	Gross weight
4008321537089	QTP-T/E 1X26...42,2X26	Shipping carton box 20	355 mm x 96 mm x 220 mm	7.50 dm ³	3192.00 g

The mentioned product code describes the smallest quantity unit which can be ordered. One shipping unit can contain one or more single products. When placing an order, for the quantity please enter single or multiples of a shipping unit.

Product datasheet

Disclaimer

Subject to change without notice. Errors and omission excepted. Always make sure to use the most recent release.

QTP-T/E 1X26...42,2X26

QUICKTRONIC PROFESSIONAL M | ECG for CFL

Product name	Lamp group	Nominal current	Nominal wattage + Power loss	Power factor λ [PIM]	Luminous flux at 25 °C	Number of lighting outlets
QTP-T/E 1X26...42,2X26	DULUX D/E 26 W	0.24 A	54.00 W	0.98	2*1750 lm	2
	DULUX T/E 26 W	0.24 A	54.00 W	0.98	1750 lm	2
	DULUX D/E 26 W	0.13 A	28.00 W	0.95	1750 lm	1
	DULUX T/E 26 W	0.13 A	28.00 W	0.95	1750 lm	1
	DULUX T/E 32 W	0.15 A	35.00 W	0.95	2400 lm	1
	DULUX T/E 32 W CONSTANT	0.15 A	35.00 W	0.95	2400 lm	1
	DULUX T/E 42 W	0.20 A	45.00 W	0.95	3200 lm	1
	DULUX T/E 42 W CONSTANT	0.20 A	45.00 W	0.95	3200 lm	1