

FieldFox Handheld Analyzers

4/6.5/9/14/18/26.5/32/44/50 GHz

This configuration guide describes configurations, options and accessories for the FieldFox family of portable analyzers. This guide should be used in conjunction with the technical overview and data sheet for a complete description of the analyzers. The table on Page 3 titled “FieldFox Family and Options” shows a comparison of the functions available in the FieldFox family of analyzers.

Note: Combination analyzer (combo) = Cable and antenna tester (CAT) + Vector network analyzer (VNA) + Spectrum analyzer (SA)



Included accessories

The following accessories are included with every FieldFox:

- AC/DC adapter
- Battery
- Soft carrying case
- LAN cable
- Quick Reference Guide



Table of Contents

FieldFox Family and Options	3
FieldFox RF and Microwave (Combination) Analyzers	4
Analyzer models	4
Analyzer options	5
FieldFox RF and Microwave (Combination) Analyzer FAQs	6
ERTA System Typical Configuration.....	11
FAQs – Applicable to All FieldFox RF and Microwave Analyzers	12
FieldFox Microwave Vector Network Analyzers.....	14
Analyzer models.....	14
FieldFox Microwave Vector Network Analyzer FAQs	15
FieldFox Microwave Spectrum Analyzers.....	16
Analyzer models.....	16
Analyzer options.....	16
FieldFox Spectrum Analyzer FAQs.....	18
Upgrades.....	19
FieldFox microwave (combination) analyzer upgrades N9913AU, N9914AU, N9915AU, N9916AU, N9917AU, N9918AU, N9950AU, N9951AU, N9952AU	19
FieldFox signal analyzer upgrades N9935AU, N9936AU, N9937AU, N9938AU, N9960AU, N9961AU, N9962AU.....	20
FieldFox VNA upgrades N9925AU, N9926AU, N9927AU, N9928AU	21
FieldFox RF and microwave analyzers hardware upgrades.....	21
Documentation	22
Calibration Kits	22
Accessories	25

FieldFox Family and Options

Option	Description	Combination Analyzers N991xA, N995xA	Vector Network Analyzers N992xA	Spectrum Analyzers N993xA, N996xA
CAT/vector network analysis				
010	VNA time domain	√	√	—
112	QuickCal	√ on N991xA (Not on N995xA)	√	—
210	VNA transmission/reflection	√	Base model ¹	—
211	VNA full 2-port S-parameters	√	√	—
212	1-port mixed-mode S-parameters	√	√	—
215	TDR cable measurements	√	√	—
305	Cable and antenna analyzer	Base model ¹	√	— ²
308	Vector voltmeter	√	√	—
320	Reflection meas. (RL, VSWR and scalar meas.)	— ³	— ³	√
Spectrum analysis				
209	Extended range transmission analysis (ERTA)	√	—	√
220	Tracking generator	— ⁴	—	√
233	Spectrum analyzer	√	—	Base model ¹
235	Pre-amplifier	√	—	√
236	Interference analyzer and spectrogram	√	—	√
238	Spectrum analyzer time gating	√	—	√
312	Channel scanner	√	—	√
350	Real-time spectrum analyzer (RTSA)	√ (Not on N9912A)	—	√
351	I/Q Analyzer (IQA)	√ (Not on N9912A)	—	√
352	Indoor and outdoor mapping	√ (Not on N9912A)	—	√
355	Analog demodulation	√	—	√
356	Noise figure (NF)	√ (Not on N9912A)	—	√
358	EMF measurements	√ (Not on N9912A)	—	√
360	Phased array antenna support	√ (N995xA only)	—	√ (N996xA only)
370	Over-the-Air (OTA) LTE FDD	√ (Not on N9912A)	—	√
371	Over-the-Air (OTA) LTE TDD	√ (Not on N9912A)	—	√
377	Over-the-Air (OTA) 5GTF	√ (Not on N9912A)	—	√

1. Base model means that the functionality listed is the primary function of that instrument. For example, on the N991xA or N995xA combo analyzers, cable and antenna analysis is the standard function included with every N991xA or N995xA.
2. Option 305 is not available on the N993xA or N996xA. However, a subset of cable and antenna analyzer measurements, return loss and VSWR, is available as Option 320.
3. Option 320 is not applicable to N991xA, N995xA, or N992xA. The reflection measurements of return loss and VSWR are included with every N991xA, N995xA, and N992xA. So, there is no need for an Option 320 on these analyzers.
4. On the N991xA or N995xA analyzers, order Options 233 and 210 to obtain a tracking generator with the spectrum analyzer. Option 220 is not available on the N991xA or N995xA analyzers. Option 233 provides the spectrum analyzer capability and Option 210 the "tracking" capability.

Option	Description	Combination Analyzers N991xA, N995xA	Vector Network Analyzers N992xA	Spectrum Analyzers N993xA, N996xA
Power measurements				
208	USB power sensor meas. versus frequency	√	√	√
302	USB power sensor support	√	√	√
310	Built-in power meter	√	√	√
330	Pulse meas. with USB peak power sensor	√	√	√
System features				
030	Remote control capability	√	√	√
307	GPS receiver	√	√	√
309	DC bias variable-voltage source	√ (Not on N9912A)	√	√
—	Frequency extender support ¹	√ (Not on N9912A)	—	√
Windows based software				
89601B	PathWave VSA (89600 VSA) software	√ (Not on N9912A)	—	√
N6820ES	Surveyor 4D software	√ (Not on N9912A)	—	√

1. Frequency extenders are not currently supported on models N9913A, N9914A and N9915/35A since the starting LO frequency of these mixers is higher than 9 GHz and the LO is provided to the mixer from FieldFox Port 1. For a list of supported OML frequency extenders, see Accessories page 23.

FieldFox RF and Microwave (Combination) Analyzers

Analyzer models

Step 1. Select the model that provides the desired frequency range.

Model	Description	CAT and VNA frequency	SA frequency ¹	Test port connectors
N9913A	4 GHz FieldFox RF analyzer	30 kHz to 4 GHz	100 kHz to 4 GHz	Type-N (f)
N9914A	6.5 GHz FieldFox RF analyzer	30 kHz to 6.5 GHz	100 kHz to 6.5 GHz	Type-N (f)
N9915A	9 GHz FieldFox microwave analyzer	30 kHz to 9 GHz	100 kHz to 9 GHz	Type-N (f)
N9916A	14 GHz FieldFox microwave analyzer	30 kHz to 14 GHz	100 kHz to 14 GHz	Type-N (f)
N9917A	18 GHz FieldFox microwave analyzer	30 kHz to 18 GHz	100 kHz to 18 GHz	Type-N (f)
N9918A	26.5 GHz FieldFox microwave analyzer	30 kHz to 26.5 GHz	100 kHz to 26.5 GHz	3.5 mm (m)
N9950A	32 GHz FieldFox microwave analyzer	300 kHz to 32 GHz	9 kHz to 32 GHz	NMD 2.4 mm (m)
N9951A	44 GHz FieldFox microwave analyzer	300 kHz to 44 GHz	9 kHz to 44 GHz	NMD 2.4 mm (m)
N9952A	50 GHz FieldFox microwave analyzer	300 kHz to 50 GHz	9 kHz to 50 GHz	NMD 2.4 mm (m)

1. Useable to 5 kHz.

Analyzer options

Step 2. Select optional measurement capabilities.

Any of these options can easily be added as a software upgrade in the future. Exception: Option 112 is only applicable to N991xA models. It is not applicable to N995xA models.

Option	Description	Prerequisite options/notes
CAT/vector network analysis		
010	VNA time domain	Requires 210, recommend 211. See page 7, FAQ #7
112	QuickCal	Not available for N995xA models. See page 7, FAQ #9
210	VNA transmission/reflection	Recommend ordering a cal kit. See page 6, FAQ #4 and page 7, FAQ #6
211	VNA full 2-port S-parameters	Requires 210, recommend ordering a cal kit. See page 6, FAQ #5
212	1-port mixed-mode S-parameters	Requires 210 and 211
215	TDR cable measurements	—
308	Vector voltmeter	210 and 211 required to obtain full VVM functionality. See page 7, FAQ #8
Spectrum analysis		
209	Extended range transmission analysis (ERTA)	Requires 233 and 210. Recommend 307. Requires two FieldFox units. See page 8, FAQ # 10. See page 10 for typical configuration.
233	Spectrum analyzer	—
235	Pre-amplifier	Requires 233
236	Interference analyzer and spectrogram	Requires 233
238	Spectrum analyzer time gating	Requires 233
312	Channel scanner	Requires 233
350	Real-time spectrum analyzer (RTSA) ¹	Requires 233, Recommend 235. See page 8, FAQ #12
351	I/Q Analyzer (IQA) ¹	Requires 233
352	Indoor and outdoor mapping	Requires 233, 307, and at least one of 312, 360, 370, 371 or 377. See page 9, FAQ #17
355	Analog demodulation	Requires 233
356	Noise Figure (NF) ¹	Requires 233, 235, 309 and accessory item N9910X-713 BNC to SMB cable. See page 9, FAQ #15 for external preamplifier and noise source requirements.
358	EMF measurements	Requires 233. Also requires triaxial antenna. See page 9, FAQ #18
360	Phased array antenna support	Requires 233. See page 9, FAQ #16
370	Over-the-Air (OTA) LTE FDD ¹	Requires 233, 307. Recommend 235.
371	Over-the-Air (OTA) LTE TDD ¹	Requires 233, 307. Recommend 235.
377	Over-the-Air (OTA) 5GTF ¹	Requires 233, 307. Recommend 235. See page 9, FAQ #19

1. Requires CPU2 fast processor. See page 9, FAQ #13.

Option	Description	Prerequisite options/notes
Power measurements		
208	USB power sensor meas. versus frequency	Requires 302
302	USB power sensor support	Need to order USB power sensor ²
310	Built-in power meter	No power sensor required. See page 11, FAQ #1
330	Pulse meas. with USB peak power sensor	Need to order USB peak power sensor. See page 12, FAQs #7 and #8
System features		
030	Remote control capability	Requires an iOS device
307	GPS receiver	Need to order GPS antenna, N9910X-825. See page 12, FAQ #3
309	DC bias variable-voltage source	Recommend N9910X-713 cable, see page 12, FAQ #4
—	Frequency extender support	Requires 233. Optional 350, 351, 360, 370, 371, 377, PathWave VSA software. See Accessories, page 23
Windows based software		
89601B	PathWave VSA (89600 VSA) software	Requires 233 and CPU2 processor. See page 9, FAQ #13
N6820ES	Surveyor 4D software ¹	Requires 233, 235 and 307, see page 10, FAQ #20

1. Requires CPU2 fast processor. See page 9, FAQ #13.

2. List of compatible sensors available from www.keysight.com/find/fieldfoxsupport.

FieldFox RF and Microwave (Combination) Analyzer FAQs

Question	Answer
1. What is included with a base N991xA/N995xA analyzer?	The base model includes the cable and antenna analyzer
	Measurements: DTF (dB, linear, VSWR), return loss and DTF, return loss (dB), and 1-port cable loss
	Calibrations: CalReady, OSL, and response cal
	Note: 2-port insertion loss is NOT included with the base model, if 2-port insertion loss is needed, order Option 210
	Note: Base analyzer does not have phase information, for S11 or S21 phase, order Option 210
2. What is included with N991xA/N995xA Option 233?	Basic spectrum analysis, four traces, different detector types, radio standard selection, limit lines
	Channel power, occupied bandwidth, adjacent channel power, spectrum emission mask
	AM/FM tune and listen, field strength measurements, antenna factors, frequency counter marker
	Tracking generator (TG)/Independent source: <ul style="list-style-type: none"> • TG CW mode (source CW frequency can be set independent of SA frequency) - included • TG CW coupled mode (source CW frequency is auto coupled to SA's center frequency) - included • TG tracking mode (traditional TG operation, swept SA coupled to swept source) - (requires Option 210)

Question	Answer
3. What is included with N991xA/N995xA Option 236?	Interference analyzer and spectrogram
	Trace playback and recording
4. What is included with N991xA/N995xA Option 210?	Option 210 adds a VNA with transmission/reflection (T/R) capability
	Measurements: S21, S11, magnitude and phase
	Additionally, in the CAT mode, you can measure 2-port insertion loss
	Calibrations: CalReady, OSL, response, and enhanced response cal
	If you need all four S-parameters, order Options 210 and 211
	If you need 2-port cal, order Options 210 and 211
	Adds tracking mode to the tracking generator/independent source included with Option 233, spectrum analyzer
5. What is included with N991xA/N995xA Option 211?	Option 211 adds full 2-port S-parameter capability to the VNA mode
	Measurements: All four S-parameters (S11, S21, S22, S12), magnitude and phase
	Calibrations: CalReady, OSL, response, enhanced response, and full 2-port cal
6. Can I measure group delay on N991xA/ N995xA analyzers?	If you have phase measurement capability, then you can measure group delay. Option 210 is required for any phase measurement capability. So, if you do not have Option 210, you cannot measure group delay.
7. What is included with N991xA/N995xA Option 010?	S11/S21 in time domain, if Option 210 is ordered. To get time domain data for all four S-parameters and full 2-port cal, order Option 211.
	View both time and frequency domain data at the same time
	Low-pass, impulse, and band-pass modes
	Minimum, medium, and maximum window
	Gating
8. What is included with N991xA/N995xA Option 308?	With Option 308: 1-port cable trimming
	With Options 308 and 210: 1-port cable trimming, 2-port transmission
	With Options 308, 210, and 211: 1-port cable trimming, 2-port transmission, A/B and B/A
	Note: A/B and B/A measurements require an external source
9. What is included with N991xA Option 112?	Option 112 (QuickCal), is not available for N995xA analyzers. It is available for N991xA analyzers.
	QuickCal is included with Option 112. <ul style="list-style-type: none"> • 1-port QuickCal with a base analyzer • 1-port and enhanced response QuickCal with a T/R analyzer (one that has Option 210) • 1-port, enhanced response, and 2-port QuickCal with a full 2-port analyzer (one that has Option 211)

Question	Answer
	<p>QuickCal is most accurate for DUTs with 7/16 and Type-N connectors and measurement uncertainties are provided for frequencies ≤ 18 GHz. Reduced accuracy for DUTs with 3.5 mm (m), SMA (m), or other male coaxial connectors; performance is unspecified. QuickCal is not recommended for DUTs with 3.5 mm (f), SMA (f), or other similar female connectors. QuickCal is not applicable to waveguide.</p>
<p>10. What are the requirements for Option 209?</p>	<p>Extended Range Transmission Analysis (ERTA) or Option 209 is a scalar measurement system based on the use of two (2) FieldFox units. One FieldFox acts as the <i>source</i> and reference receiver, while the second FieldFox acts as the <i>measurement</i> receiver. When different frequency models are used in an ERTA pair, the ERTA system frequency range is limited to the lowest of the pair.</p> <p>Required hardware</p> <p>A. Two (2) FieldFox units. FieldFox units can be any of these models:</p> <ul style="list-style-type: none"> • FieldFox microwave combination analyzers: N9913A, N9914A, N9915A, N9916A, N9917A, N9918A, N9950A, N9951A, N9952A • FieldFox microwave spectrum analyzers: N9935A, N9936A, N9937A, N9938A, N9960A, N9961A, N9962A • ERTA cannot use N9912A, N9923A, N9925A, N9926A, N9927A or N9928A <p>The two FieldFox units used in ERTA do not have to be the same model.</p> <p>ERTA requires the following options on Combo FieldFox models (N9913A, N9914A, N9915A, N9916A, N9917A, N9918A, N9950A, N9951A, N9952A):</p> <ul style="list-style-type: none"> • Option 210, VNA transmission/reflection • Option 233, spectrum analyzer <p>ERTA requires the following options on SA FieldFox models (N9935A, N9936A, N9937A, N9938A, N9960A, N9961A, N9962A)</p> <ul style="list-style-type: none"> • Option 220, tracking generator <p>Both FieldFox units (the one used as the source, and the other used as the receiver) must have the options listed above. The ERTA option (209) cannot be installed unless 210 and 233 are present on a combo analyzer; or 220 is present on a SA analyzer.</p> <p>With either the Combo or SA FieldFox units, the following options are highly recommended:</p> <ul style="list-style-type: none"> • Option 235, preamplifier – this option increases the measurement dynamic range by increasing the received signal power • Option 307, GPS receiver – this option increases the dynamic range by increasing the frequency accuracy and permitting the use of a narrower RBW <p>B. Power splitter, two-resistor model, Keysight 11667A, 11667B, or 11667C. Other power splitters can be used but the specifications listed are based on the match and tracking performance of 11667A, 11667B, or 11667C. Three-resistor power splitters are not recommended.</p> <p>C. N9910X-712, Trigger/Reference-in cable, SMA (m) to BNC(f), 1 m, quantity two</p> <p>D. N9910X-713, Trigger/Reference-out cable, SMB (m) to BNC (m), 1 m, quantity two</p> <p>E. LAN connection – For ERTA, the two FieldFox units communicate via a LAN connection. For a direct connection, a cross-over LAN cable is required. Alternately, both analyzers can be on a local area network.</p> <p>Recommended accessory</p> <p>F. N9910X-825, GPS Antenna</p>
<p>11. What is included with Option 355?</p>	<p>FieldFox analog demodulation has two parts: (1) Tune and listen, and (2) AM/FM metrics. Tune and listen is available with the purchase of the spectrum analyzer option 233. AM/FM metrics becomes available when Option 355 is purchased. AM/FM metrics provides the user with RF spectrum view, demodulated baseband signal waveform, carrier power, frequency deviation, SINAD and more.</p>

Question	Answer												
12. What is included with Option 350?	Real-time spectrum analyzer (RTSA) or Option 350 provides real-time measurements on a FieldFox. The FieldFox must be equipped with spectrum analysis capability. The preamplifier option is recommended, as elusive signals often have low power levels. The maximum real-time bandwidth for option 350 is 10 MHz. RTSA includes trace recording and playback capabilities. It does not include a frequency-mask trigger (FMT).												
13. How do I determine if my FieldFox has CPU2 fast processor?	All N995xA and N996xA analyzers include CPU2. On other FieldFox models, if the serial number starts with MY5607/SG5607/US5607, then it has CPU2. If the serial number prefix is different, then the analyzer firmware needs to be checked to see if the instrument has been upgraded with N9910HU-100/200/300/400 to have CPU2.												
14. Is Spectrum Analyzer Trace Recording and Playback standard or an option?	Spectrum Analyzer mode (Option 233) does not include Trace Recording and Playback by default. To obtain this capability in SA mode, Option 236 Interference Analyzer and Spectrogram needs to be purchased.												
	RTSA mode (Option 350) does include Trace Recording and Playback by default in RTSA mode.												
	Purchasing RTSA mode (Option 350) does not enable Trace Recording and Playback in SA mode (Option 233).												
	<table border="1"> <thead> <tr> <th>Trace record/playback features</th> <th>SA mode SA and Interference Analyzer Options 233 and 236</th> <th>RTSA mode RTSA Option 350</th> </tr> </thead> <tbody> <tr> <td>Record and playback spectrum traces</td> <td>Yes</td> <td>Yes</td> </tr> <tr> <td>Save trace data with GPS time stamp over time</td> <td>Yes</td> <td>Yes</td> </tr> <tr> <td>Record and playback spectrogram data</td> <td>Yes</td> <td>No ¹</td> </tr> </tbody> </table>	Trace record/playback features	SA mode SA and Interference Analyzer Options 233 and 236	RTSA mode RTSA Option 350	Record and playback spectrum traces	Yes	Yes	Save trace data with GPS time stamp over time	Yes	Yes	Record and playback spectrogram data	Yes	No ¹
	Trace record/playback features	SA mode SA and Interference Analyzer Options 233 and 236	RTSA mode RTSA Option 350										
Record and playback spectrum traces	Yes	Yes											
Save trace data with GPS time stamp over time	Yes	Yes											
Record and playback spectrogram data	Yes	No ¹											
15. What are the requirements for Noise figure (NF) Option 356?	Requires spectrum analyzer mode (Option 233 on combination models), internal preamplifier (Option 235) and DC bias variable voltage source (Option 309) as well as CPU2 processor. An external noise source is also required and FieldFox supports Keysight noise source models 346A/B/C/K40/K01. Also recommended to improve accuracy is an external preamplifier Keysight models U7227A/C/F or U7228A/C/F. Requires accessory item N9910X-713 BNC to SMB cable for DC bias variable voltage source to noise source connection.												
16. What is required for phased array antenna support (Option 360)?	Requires spectrum analyzer mode (Option 233 on combination models). Recommend GPS receiver (Option 307) and internal preamplifier (Option 235). Supported only on N995xA and N996xA models, since phased array antenna operates at 28 GHz.												
17. What is included with indoor and outdoor mapping (Option 352)?	FieldFox's mapping function is available in the following modes: Channel Scanner (312), Phased-Array Antenna (360), OTA LTE FDD/TDD (370/371), and OTA 5GTF (377). Mapping is currently not available in SA or RTSA modes. Outdoor mapping requires the availability of GPS (Option 307). Maps can be saved to the FieldFox internal memory, SD card or USB drive. Using a direct wired LAN connection, FieldFox will automatically access OSM once location coordinates (latitude and longitude) and zoom levels have been entered the Map Explorer menu. If using the FieldFox Map Support Tool , OSM map files can be downloaded to a .zip file and imported to FieldFox internal memory. If the FieldFox GPS receiver is enabled and OSM maps have been previously saved to FieldFox with those GPS coordinates, FieldFox can automatically load the corresponding map to match the current GPS coordinates.												
18. What is required for EMF measurements (Option 358)?	Requires triaxial antenna, not sold or provided by Keysight. Supported antenna is AGOS advanced technologies Triaxial Isotropic Antenna model SDIA-6000 30 MHz to 6 GHz. EMF measurements are supported with spectrum analyzer mode (Option 233 on combination models).												

1. RTSA trace recordings can be recalled and played back in SA mode Spectrogram. This has the added benefit that the measurements are shown 'slower', making it easier for the human eye to decipher the signal content.

Question	Answer
<p>19. What is required for 5GTF over-the-air (OTA) measurements (Option 377)?</p>	<p>Recommend 32, 44 or 50 GHz FieldFox model (N995xA and N996xA) to support 5GTF FR2 frequency of 28 GHz. Requires spectrum analyzer mode (Option 233 on combination models). Also recommend GPS receiver (Option 307) and internal preamplifier (Option 235). FieldFox models 26.5 GHz and below will require external mixer to down convert millimeter wave frequency to intermediate frequency (IF). For Keysight direct sales, mixer is orderable as Keysight model N9910XM28-H2A for 3.5 mm test ports or N9910XM28-H2N for Type-N test ports. For indirect sales, the mixer is orderable as OML Inc. model M28H2ADC-K, please see website www.omlinc.com for more information or contact a Keysight representative. OML mixer RF input interface is 2.92 mm (f).</p>
<p>20. What is required for N6820ES Surveyor 4D software?</p>	<p>Surveyor 4D software connected to FieldFox spectrum analyzer mode offers a versatile, truly portable spectrum monitoring system that covers VLF to 50 GHz, including 5G millimeter wave bands. The software runs on an external PC or tablet. FieldFox required options include spectrum analyzer mode (Option 233 on combination models), preamplifier (Option 235) and built-in GPS receiver (Option 307). Core Surveyor 4D software for Windows (Option N6820ES-114) is required to run the Surveyor 4D software. Other Surveyor 4D software optional licenses that are supported include basic modulation recognition application (N6820ES-MR1) and universal signal detection (N6820ES-USD). Requires Surveyor 4D software version 4.3 or later (May 2019).</p>

ERTA System Typical Configuration

Item	Description/Options	Quantity
FieldFox	Combo analyzer: Required Options 210, 233. Recommended: 235, 307 SA analyzer: Required: Option 220. Recommended: 235, 307	2
Power splitter	11667A (Type-N) or 11667B (3.5 mm) or 11667C (2.4 mm)	1
Type-N(m) to Type-N(m) adapter	N9910X-850 (for use with 11667A or Type-N systems)	1
Trigger cables ¹	N9910X-712, SMA(m) to BNC(f) N9910X-713, SMB(m) to BNC(m)	2 of each Total of 4 cables
RF test cable	Connecting FieldFox source port 1 to power splitter input	1
RF test cable or adapter	Connecting power splitter output arm to FieldFox port 2	1
RF jumper cable or adapter	Power splitter output arm to DUT input	1
RF jumper cable or adapter	DUT output to FieldFox receiver port 2	1
LAN cable	LAN cable to connect two FieldFox units directly, or the analyzers must be on the LAN	1
N9910X-825	GPS antenna, recommended. Necessary if Option 307 is ordered.	2

1. The trigger cables and LAN cables must be at least as long as the separation distance between the two ends of the DUT.

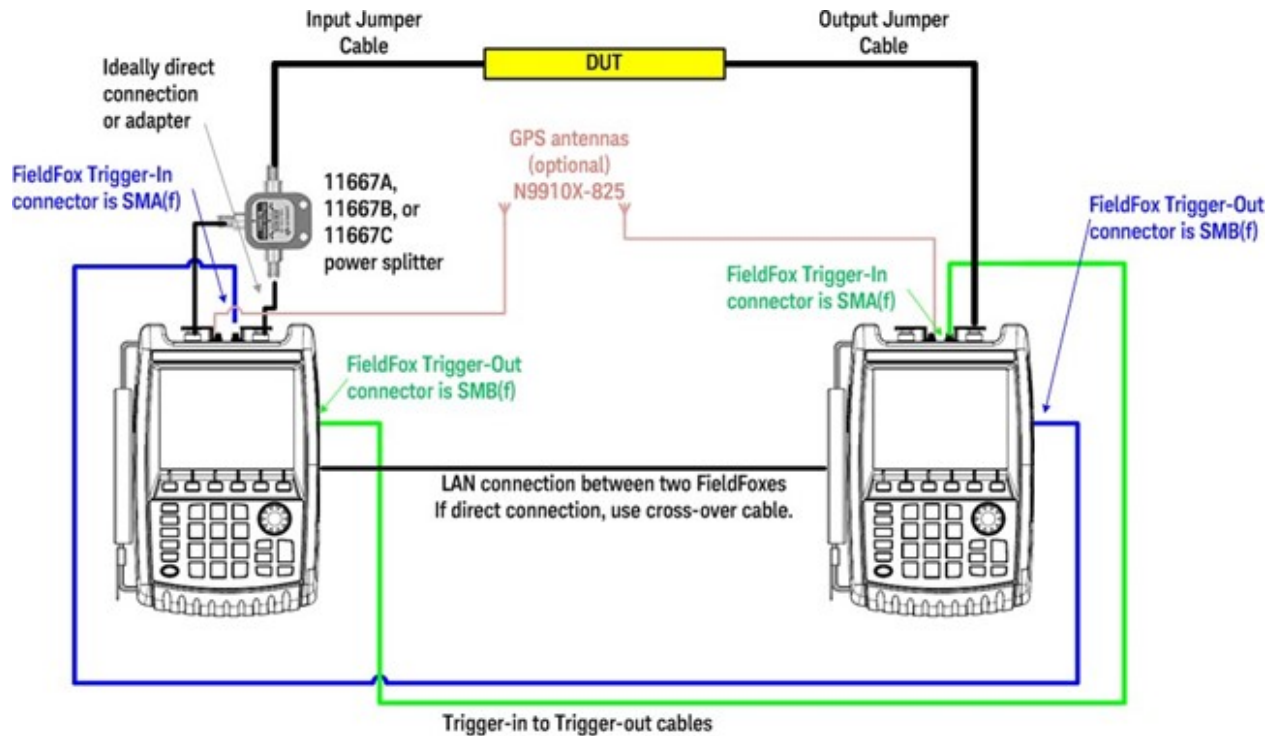
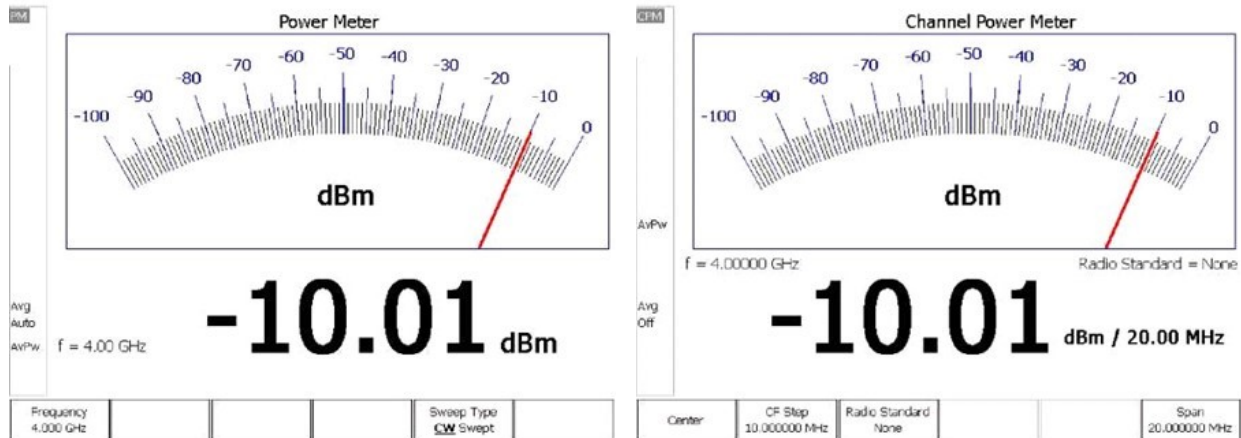

Figure 1: ERTA system diagram

FAQs – Applicable to All FieldFox RF and Microwave Analyzers

Question	Answer		
1. What USB power sensors work with Option 302?	All Keysight U2000x Series USB power sensors are supported with FieldFox. Visit: www.keysight.com/find/fieldfoxsupport for an up-to-date listing.		
2. What is the difference between USB power sensor (Option 302) and built-in power meter (Option 310)?	Option 302 USB power sensor	Option 310 Built-in power meter (or channel power meter)	
	Description	Option 302 allows users to connect a USB power sensor to FieldFox's USB port and make broadband power measurements	Option 310 is a channelized power measurement capability built into FieldFox analyzers. Maximum bandwidth is 100 MHz.
	External hardware	USB power sensor required	None. Uses internal receiver.
	Power measurement	Broadband diode detector, measures all frequencies	Tuned receiver, so measures frequencies within defined channel bandwidth
	Frequency range	Depends on USB sensor	Frequency range of the analyzer
	Settings	Set CW frequency	Set CW frequency, Set channel width/span
	Power range	Depends on USB sensor	Depends on channel width and attenuator setting.
	Warm-up time	30 minutes to meet accuracy specifications	No warm-up time required
	Accuracy	Depends on USB sensor	InstAlign accuracy: ± 0.5 dB typical for a CW signal. Since the measurement is within a certain frequency channel or bandwidth, to make an accurate measurement, the user needs to know the exact center frequency and the signal's bandwidth and set those accurately.
	Programmable	Yes, via SCPI	Yes, via SCPI
Physical connection	The power sensor can easily be moved to the measurement point, with a USB cable connecting the detector to FieldFox.	The measurement point needs to be connected to FieldFox's RF input port. If an RF jumper cable is used, the user needs to account for the loss of the cable with an offset value (can be entered into the analyzer).	
FieldFox source control	Yes, on/off, and nominal power level control	No access to FieldFox's source from the built-in power meter mode	



Question	Answer
3. What do I need to get GPS information?	1. The recommended GPS solution is to order: <ul style="list-style-type: none"> • Option 307 - built-in GPS receiver • A GPS antenna such as N9910X-825 • Other GPS antennas can also be used • The GPS connector on the instrument is SMA (f) 2. Alternatively, you can purchase a USB-based GPS receiver. You do not need to purchase any FieldFox options for the USB-based GPS to work. However, the USB-based GPS only provides time and location data, and time synchronization capability. It cannot be used to increase the frequency accuracy of the instrument.
4. What is the connector for Option 309, DC output?	The DC output has a SMB (m) connector. Recommend ordering N9910X Option 713 bias-tee power cable SMB (f) to BNC (m).
5. What are the connectors for the Reference/Trigger In and Reference/Trigger Out?	The connector for the Ref/Trig In is SMA (f). Recommend ordering N9910X Option 712 Trig/Ref in SMA (m) to BNC (f) cable. The connector for the Ref/Trig Out is SMB (m). Recommend ordering N9910X Option 713 bias-tee power cable SMB (f) to BNC (m).
6. What is Option 030 remote control capability?	1. Option 030 provides a license for FieldFox to allow remote control via an iOS device. 2. Not supplied by user, but necessary for operation of Option 030 are: <ul style="list-style-type: none"> • iOS device: iPad, iPhone, or iPod Touch with iOS 6.1 or higher with free FieldFox app • A WiFi or 3G/4G network connection between FieldFox and iOS device
7. What USB sensor is required for Option 330?	Option 330 or pulse measurements requires a Keysight USB peak power sensor. Visit www.keysight.com/find/usbsensorsforfieldfox for a list of supported peak power sensors. Average power sensors cannot be used with Option 330, only peak power sensors. The peak power sensor needs to be purchased separately. Option 330 or pulse measurement requires Option 302 and Keysight USB power sensor
8. What measurement capabilities are included with Option 330?	Average power, peak power, and peak to average ratio
	Analog gauge display and digital display, dBm and watts
	Relative/absolute measurements, dB or %, minimum and maximum limits
	Trace graph for pulse profiling with gating
	Rise time, fall time, pulse width, pulse period, pulse repetition frequency
9. What is included with Option 208?	Option 302, USB power sensor measurements, includes CW power measurements (one frequency at a time). With Option 208 added, you can make swept-frequency power measurements. You can plot source power, gain, and receive power versus frequency. Additionally, the source frequency can be offset from the receiver frequency. The power sensor needs to be purchased separately.

FieldFox Microwave Vector Network Analyzers

Analyzer models

Step 1. Select the model that provides the desired frequency range.

Model	Description	Frequency	Test port connectors
N9925A	9 GHz FieldFox microwave VNA	30 kHz to 9 GHz	Type-N (f)
N9926A	14 GHz FieldFox microwave VNA	30 kHz to 14 GHz	Type-N (f)
N9927A	18 GHz FieldFox microwave VNA	30 kHz to 18 GHz	Type-N (f)
N9928A	26.5 GHz FieldFox microwave VNA	30 kHz to 26.5 GHz	3.5 mm (m)

A standard N992xA FieldFox microwave VNA includes transmission/reflection measurement capability. Additional functionality such as full 2-port S-parameters can be added using the options listed below.

Analyzer options

Step 2. Select optional measurement capabilities. Any of these options can easily be added as a software upgrade in the future.

Option	Description	Prerequisite options/notes
Vector network analysis/CAT		
010	VNA time domain	Recommend 211. See page 14, FAQ #3
112	QuickCal	See page 14, FAQ #7
211	VNA full 2-port S-parameters	—
212	1-port mixed-mode S-parameters	Requires 211
215	TDR cable measurements	Requires 305
305	Cable and antenna analyzer	—
308	Vector voltmeter	211 required to obtain full VVM functionality. See page 14, FAQ #5
Power measurements		
208	USB power sensor meas. versus frequency	Requires 302
302	USB power sensor support	Need to order USB power sensor ¹
310	Built-in power meter	No power sensor required. See page 11, FAQ #1
330	Pulse meas. with USB peak power sensor	Need to order USB peak power sensor. See page 12, FAQs #7 and #8
System features		
030	Remote control capability	Requires an iOS device
307	GPS receiver	Need to order GPS antenna, N9910X-825. See page 12, FAQ #3
309	DC bias variable-voltage source	Recommend N9910X-713 cable, see page 12, FAQ #4

1. List of compatible sensors available from www.keysight.com/find/fieldfoxsupport

FieldFox Microwave Vector Network Analyzer FAQs

Question	Answer
1. What is included with a base N992xA analyzer?	Measurements: Transmission/reflection or S21 and S11, magnitude and phase
	Calibrations: CalReady, OSL, response, and enhanced response cal
2. What is included with N992xA Option 211?	Option 211 adds full 2-port S-parameter capability
	Measurements: All four S-parameters (S11, S21, S22, S12), magnitude and phase
	Calibrations: CalReady, OSL, response, enhanced response, and full 2-port cal
3. What is included with N992xA Option 010?	S11/S21 in time domain. To get time domain data for all four S-parameters and full 2-port cal, order Option 211
	View both time and frequency domain data at the same time
	Low-pass, impulse, and band-pass modes
	Minimum, normal, and maximum window
	Gating
4. What is included with N992xA Option 305?	Measurements: DTF (dB, Linear, VSWR), return loss and DTF, return Loss (dB), and 1-port cable loss, 2-port insertion loss
	TDR (linear, ohm). TDR measurements require Option 215, in addition to Option 305.
	Calibrations: CalReady, OSL, and response cal
5. What is included with N992xA Option 308?	N992xA with Option 308: 1-port cable trimming, 2-port transmission
	N992xA with Options 308 and 211: 1-port cable trimming, 2-port transmission, A/B and B/A
	Note: A/B and B/A measurements require an external source
6. If I have the full 2-port VNA with time domain, why would I order Option 305? What additional functionality is available?	<p>CAT mode's basic measurements are similar to VNA measurements. The features listed below are often used for distance-to-fault cable testing and are only available in CAT mode:</p> <ul style="list-style-type: none"> • 3-peak marker tracking for finding faults for DTF measurements • 1-port cable loss • Cable type selection and editing, includes the cable's velocity factor and loss
7. What is included with N992xA Option 112?	<p>QuickCal is included with Option 112.</p> <ul style="list-style-type: none"> • 1-port and enhanced response QuickCal with a base analyzer • 1-port, enhanced response, and 2-port QuickCal with a full 2-port analyzer (one that has Option 211).
	<p>QuickCal is most accurate for DUTs with 7/16 and Type-N connectors and measurement uncertainties are provided for frequencies 18 GHz. Reduced accuracy for DUTs with 3.5 mm (m), SMA (m), or other male coaxial connectors; performance is unspecified. QuickCal is not recommended for DUTs with 3.5 mm (f), SMA (f), or other similar female connectors. QuickCal is not applicable to waveguide.</p>
Additional FAQs on pages 11 and 12.	FAQs on pages 11 and 12 apply to all microwave FieldFox models.

FieldFox Microwave Spectrum Analyzers

Analyzer models

Step 1. Select the model that provides the desired frequency range.

Model	Description	Frequency range ¹	Test port connectors
N9935A	9 GHz FieldFox microwave spectrum analyzer	100 kHz to 9 GHz	Type-N (f)
N9936A	14 GHz FieldFox microwave spectrum analyzer	100 kHz to 14 GHz	Type-N (f)
N9937A	18 GHz FieldFox microwave spectrum analyzer	100 kHz to 18 GHz	Type-N (f)
N9938A	26.5 GHz FieldFox microwave spectrum analyzer	100 kHz to 26.5 GHz	Type-N (f) ²
N9960A	32 GHz FieldFox microwave spectrum analyzer	9 kHz to 32 GHz	NMD 2.4 mm (m)
N9961A	44 GHz FieldFox microwave spectrum analyzer	9 kHz to 44 GHz	NMD 2.4 mm (m)
N9962A	50 GHz FieldFox microwave spectrum analyzer	9 kHz to 50 GHz	NMD 2.4 mm (m)

1. Useable to 5 kHz.
2. Order Option 100 for 3.5 mm (m) test port connectors. With N9938A-100, the spectrum analyzer is built with 3.5 mm test port connectors instead of the standard Type-N (f). Option 100 is a prerequisite for Option 320 for N9938A. Option 100 is not available as an upgrade.

Analyzer options

Step 2. Select optional measurement capabilities. Any of these options can easily be added as a software upgrade in the future.

Option	Description	Prerequisite options/notes
Spectrum analyzer		
100 ¹	3.5 mm (m) connectors	Only available on N9938A. Not available as an upgrade.
209	Extended range transmission analysis (ERTA)	Requires 220. Recommend 307. Requires two (2) FieldFox units. See page 8, FAQ # 10. See page 10 for typical configuration.
220	Full-band tracking generator	CW, CW coupled, and tracking
235	Pre-amplifier	—
236	Interference analyzer and spectrogram	—
238	Spectrum analyzer time gating	—
312	Channel scanner	—
320	Reflection measurements	320 requires 220 on all models. On N9938A specifically, 320 also requires 100.
350	Real-time spectrum analyzer (RTSA) ²	Recommend 235. See page 8, FAQ # 12
351	I/Q Analyzer (IQA) ²	—
352	Indoor and outdoor mapping	Requires 307, and at least one of 312, 360, 370, 371, or 377. See page 9, FAQ #17
355	Analog demodulation	—

Option	Description	Prerequisite options/notes
Spectrum analyzer		
356	Noise figure (NF) ²	Requires 235, 309, and accessory item N9910X-713 BNC to SMB cable. See page 9, FAQ #15 for external preamplifier and noise source requirements.
358	EMF measurements	Requires triaxial antenna. See page 9, FAQ #18
360	Phased array antenna support	See page 9, FAQ #16
370	Over-the-Air (OTA) LTE FDD ²	Requires 307, Recommend 235.
371	Over-the-Air (OTA) LTE TDD ²	Requires 307, Recommend 235.
377	Over-the-Air (OTA) 5GTF ²	Requires 307, Recommend 235. See page 9, FAQ #19
Power measurements		
208	USB power sensor meas. vs. frequency	Requires 302
302	USB power sensor support	Need to order USB power sensor ³ . See page 10, FAQ #1
310	Built-in power meter	No power sensor required. See page 10, FAQ #2
330	Pulse meas. with USB peak power sensor	Need to order USB peak power sensor. See page 11, FAQs #7 and #8
System features		
030	Remote control capability	Requires an iOS device
307	GPS receiver	Need to order GPS antenna, N9910X-825. See page 12, FAQ #3
309	DC bias variable-voltage source	Recommend N9910X-713 cable, see page 12, FAQ #4
—	Frequency extender support	Optional 350, 351, 360, 370, 371, 377, PathWave VSA software. See Accessories, page 23
Windows based software		
89601B	PathWave VSA (89600 VSA) software	Requires CPU2 processor. See page 9, FAQ #13
N6820ES	Surveyor 4D software ²	Requires 235 and 307, see page 10, FAQ #20

1. Order Option 100 for 3.5 mm (m) test port connectors. With N9938A-100, the spectrum analyzer is built with 3.5 mm test port connectors instead of the standard Type-N (f). Option 100 is a prerequisite for Option 320 for N9938A. Option 100 is not available as an upgrade.
2. Requires CPU2 fast processor. See page 9, FAQ #13.
3. List of compatible power sensors available from www.keysight.com/find/fieldfoxsupport

FieldFox Spectrum Analyzer FAQs

Question	Answer
1. What is included with the basic spectrum analyzer?	Basic spectrum analysis, four traces, different detector types, radio standard selection, limit lines
	Channel power, occupied bandwidth, adjacent channel power, spectrum emission mask
	AM/FM tune and listen, field strength measurements, antenna factors, frequency counter marker
2. What is included with Option 236?	Interference analyzer and spectrogram
	Trace playback and recording
3. What is included with Option 320?	Return loss and VSWR
	Normalization using data/memory
4. What is the difference between Option 320 and the CAT mode on the combo base model?	Option 320 on the N993xA/N996xA SA offers RL and VSWR. CAT mode on the N991xA/N995xA combo analyzers offer RL and VSWR, DTF, insertion loss, and also various calibration capabilities such as QuickCal and OSL.
5. What is included with Option 355?	FieldFox analog demodulation has two parts: (1) Tune and listen, and (2) AM/FM metrics. Tune and listen are available as a standard feature on all N993xA and N996xA FieldFox spectrum analyzers. AM/FM metrics becomes available when Option 355 is purchased. AM/FM metrics provides the user with RF spectrum view, demodulated baseband signal waveform, carrier power, frequency deviation, SINAD and more.
Additional FAQs on pages 11 and 12.	FAQs on pages 11 and 12 apply to all microwave FieldFox models.

Upgrades

Information on upgrades is available from: www.keysight.com/find/fieldfoxsupport

FieldFox microwave (combination) analyzer upgrades

N9913AU, N9914AU, N9915AU, N9916AU, N9917AU, N9918AU, N9950AU, N9951AU, N9952AU

You Can Upgrade!

Options can be added after your initial purchase.

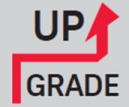

Option	Description	Upgrade contents	Additional requirements
010	VNA time domain analysis	License key	210, recommend 211
030	Remote control capability	License key	Requires an iOS device
112	Enable QuickCal	License key	None (Does not apply to N995xAU)
208	USB power sensor measurements versus frequency	License key	302
209	Extended range transmission analysis (ERTA) ¹	License key	233 and 210 ¹ , recommend 307
210	VNA transmission and reflection	License key	None
211	VNA full 2-port S-parameters	License key	210
212	Mixed-mode S-parameters	License key	210 and 211
215	TDR cable measurements	License key	None
233	Spectrum analyzer	License key	None
235	Preamplifier	License key	233
236	Interference analyzer and spectrogram	License key	233
238	Spectrum analyzer time gating	License key	233
302	External USB power sensor support	License key	None
307	GPS receiver	License key	None
308	Vector voltmeter	License key	210 and 211 for full VVM functionality
309	DC bias variable-voltage source	License key	Recommend N9910X-713 cable
310	Built-in power meter	License key	None
312	Channel scanner	License key	233
330	Pulse measurements	License key	Need to order USB peak power sensor
350	Real-time spectrum analyzer (RTSA)	License key ²	233, recommend 235
351	I/Q Analyzer (IQA)	License key ²	233
352	Indoor and outdoor mapping	License key ²	233, 307, and at least one of 312, 360, 370, 371, or 377
355	Analog demodulation	License key	233
356	Noise figure (NF)	License key ^{2,3}	233, 235, 309 and accessory cable N9910X-713
358	EMF measurements	License key ²	233. Also requires triaxial antenna. See page 9, FAQ #18
360	Phased array antenna support	License key ²	233
370	Over-the-Air (OTA) LTE FDD	License key ²	233 and 307, recommend 235
371	Over-the-Air (OTA) LTE TDD	License key ²	233 and 307, recommend 235
377	Over-the-Air (OTA) 5GTF	License key ²	233 and 307, recommend 235

1. 209 is a system based on two FieldFox units. See page 8, FAQ #10, for a detailed description of the system requirements.

2. Requires CPU2 fast processor. See page 9, FAQ #13

3. See page 9, FAQ #15 for external preamplifier and noise source requirements.

FieldFox signal analyzer upgrades
N9935AU, N9936AU, N9937AU, N9938AU, N9960AU, N9961AU, N9962AU

Option	Description	Upgrade contents	Additional requirements
030	Remote control capability	License key	Requires an iOS device
100	3.5 mm connectors	Not applicable	Not applicable
208	USB power sensor measurements versus frequency	License key	302
209	Extended range transmission analysis (ERTA)	License key	220 ¹ , recommend 307
220	Full-band tracking generator	License key	None
235	Preamplifier	License key	None
236	Interference analyzer and spectrogram	License key	None
238	Spectrum analyzer time gating	License key	None
302	External USB power sensor support	License key	None
307	GPS receiver	License key	None
309	DC bias variable-voltage	License key	Recommend N9910X-713 cable
310	Built-in power meter	License key	None
312	Channel scanner	License key	None
320	Reflection measurements	License key ²	Option 220 for all models Option 100 and 220 for N9938A
330	Pulse measurements	License key	Need to order USB peak power sensor
350	Real-time spectrum analyzer (RTSA)	License key ³	Recommend 235
351	I/Q Analyzer (IQA)	License key ³	None
352	Indoor and outdoor mapping	License key ³	307, and at least one of 312, 360, 370, 371, or 377
355	Analog demodulation	License key	None
356	Noise figure (NF)	License key ^{3,4}	235, 309 and accessory cable N9910X-713
358	EMF measurements	License key ³	Requires triaxial antenna. See page 9, FAQ #18
360	Phased array antenna support	License key ³	None
370	Over-the-Air (OTA) LTE FDD	License key ³	307, recommend 235
371	Over-the-Air (OTA) LTE TDD	License key ³	307, recommend 235
377	Over-the-Air (OTA) 5GTF	License key ³	307, recommend 235

1. 209 is a system based on two FieldFox units. See page 8, FAQ #10, for a detailed description of the system requirements.
2. On N9938A, Option 320 is only available as a software upgrade if the spectrum analyzer is already equipped with Option 100, which is 3.5 mm connectors on the test port. Option 100 must have been ordered at the time of original purchase. It cannot be upgraded later.
3. Requires CPU2 fast processor. See page 9, FAQ #13.
4. See page 9, FAQ #15 for external preamplifier and noise source requirements.

FieldFox VNA upgrades
N9925AU, N9926AU, N9927AU, N9928AU

Option	Description	Upgrade contents	Additional requirements
010	VNA time domain analysis	License key	None
030	Remote control capability	License key	None
112	Enable QuickCal	License key	None
208	USB power sensor measurements versus frequency	License key	302
211	VNA full 2-port S-parameters	License key	None
212	Mixed-mode S-parameters	License key	211
215	TDR cable measurements	License key	305
302	External USB power sensor support	License key	None
305	Cable and antenna analyzer	License key	None
307	GPS receiver	License key	None
308	Vector voltmeter	License key	211 required to obtain full VVM functionality
309	DC bias variable-voltage source	License key	None
310	Built-in power meter	License key	None
330	Pulse measurements	License key	Need to order USB peak power sensor

Information on upgrades is available from: www.keysight.com/find/fieldfoxsupport.

FieldFox RF and microwave analyzers hardware upgrades

Model number/Option ^{1,2}	Description	Upgrade contents	Additional requirements
N9910HU-100	N9913/14/15/16/17A processor upgrade	Improved performance for N9915/16/17A models	Return to service center only
N9910HU-200	N9925/26/27A processor upgrade	Improved performance for N9925/26/27A models	Return to service center only
N9910HU-300	N9935/36/37A processor upgrade	Improved performance for N9935/36/37A models	Return to service center only
N9910HU-400	N9918/28/38A processor upgrade	Improved performance for N9918/28/38A models	Return to service center only

1. Upgrades are not available for FieldFox analyzers with serial number prefix starting MY5607/SG5607/US5607, as these analyzers already have the improved hardware.
2. Please contact your local Keysight Service Center for instructions on how and where to send the instrument and how to order the factory upgrades.

Documentation

By default, a printed copy of the User's Guide is not included in FieldFox orders. If you wish to receive the printed User's Guide, please order N99xxA Option ABA.

Option	Description	Notes
N99xxA-0B0	Do not include User's Guide	
N99xxA-ABA	Printed User's Guide in English	

The latest FieldFox User's Guide (manual) is available online from: www.keysight.com/find/fieldfoxsupport. The Service Guide, SCPI Programming Guide, Quick Reference Guide, and Data Link software help file can also be found via the website above.

Calibration Kits

FieldFox analyzers support most standard HP/Agilent/Keysight mechanical calibration kits and all Keysight USB ECal modules. Component list shows calibration components, some calibration kits also include adaptors. Custom calibration kits can be created and uploaded to FieldFox using Data Link software.

Model	Description	Connector	Frequency range	Components
7-16				
N9910X-802	3-in-1 OSL Cal kit	7/16 (m)	DC to 4 GHz	Open, short, load (all male)
N9910X-803	3-in-1 OSL Cal kit	7/16 (f)	DC to 4 GHz	Open, short, load (all female)
85038A	Standard cal kit	7/16	DC to 7.5 GHz	Open, short, load (both female and male)
Type-N, 50 Ω				
N9910X-800 ¹	3-in-1 OSL cal kit	Type-N (m)	DC to 6 GHz	Open, short, load (all male)
N9910X-801 ¹	3-in-1 OSL cal kit	Type-N (f)	DC to 6 GHz	Open, short, load (all female)
85032E	Economy cal kit	Type-N (m)	DC to 6 GHz	Open, short, load (all male)
85514A	4-in-1 OSLT cal kit	Type-N (m)	DC to 9 GHz	Open, short, load, thru (all male)
85515A	4-in-1 OSLT cal kit	Type-N (f)	DC to 9 GHz	Open, short, load, thru (all female)
85032F	Standard cal kit	Type-N	DC to 9 GHz	Open, short, load (both female and male)
85518A	4-in-1 OSLT cal kit	Type-N (m)	DC to 18 GHz	Open, short, load, thru (all male)
85519A	4-in-1 OSLT cal kit	Type-N (f)	DC to 18 GHz	Open, short, load, thru (all female)
85054D	Economy cal kit	Type-N	DC to 18 GHz	Open, short, load, thru (both female and male)
85054B	Standard cal kit	Type-N	DC to 18 GHz	Open, short, fixed load, sliding load (both female and male)
85092C	ECal, 2-ports	Type-N	300 kHz to 9 GHz	Connectors configurable
N4690B/C	ECal, 2-ports	Type-N	300 kHz to 18 GHz	Connectors configurable
N4690D	ECal, 2-ports	Type-N	300 kHz to 18 GHz or DC to 18 GHz	Connectors configurable

Model	Description	Connector	Frequency range	Components
Type-N, 50 Ω				
N7550A	ECal economy, 2-ports	Type-N	DC to 4 GHz	Connectors configurable
N7551A	ECal economy, 2-ports	Type-N	DC to 6.5 GHz	Connectors configurable
N7552A	ECal economy, 2-ports	Type-N	DC to 9 GHz	Connectors configurable
N7553A	ECal economy, 2-ports	Type-N	DC to 14 GHz	Connectors configurable
N7554A	ECal economy, 2-ports	Type-N	DC to 18 GHz	Connectors configurable
Type-N, 75 Ω²				
85036B	Standard cal kit	Type-N 75 Ω	DC to 3 GHz	Open, short, load (both female and male)
85036E	Economy cal kit	Type-N(m) 75 Ω	DC to 3 GHz	Open, short, load, all male
85096C	ECal, 2-ports	Type-N(m) 75 Ω	300 kHz to 3 GHz	Connectors configurable
3.5 mm				
85520A	4-in-1 OSLT	3.5 mm (m)	DC to 26.5 GHz	Open, short, load, thru (all male)
85521A	4-in-1 OSLT	3.5 mm (f)	DC to 26.5 GHz	Open, short, load, thru (all female)
85033D/E	Economy cal kit	3.5 mm	DC to 6/9 GHz	Open, short, fixed load (both female and male)
85052D	Economy cal kit	3.5 mm	DC to 26.5 GHz	Open, short, fixed load (both female and male)
85052B	Standard cal kit	3.5 mm	DC to 26.5 GHz	Open, short, fixed load, sliding load (both female and male)
85052C	Precision TRL kit	3.5 mm	DC to 26.5 GHz	Open, short, fixed load (both female and male), two-line lengths
85093C	ECal, 2-ports	3.5 mm	300 kHz to 9 GHz	Connectors configurable
N4691B	ECal, 2-ports	3.5 mm	300 kHz to 26.5 GHz	Connectors configurable
N4691D	ECal, 2-ports	3.5 mm	300 kHz to 26.5 GHz or DC to 26.5 GHz	Connectors configurable
N7550A	ECal economy, 2-ports	3.5 mm	DC to 4 GHz	Connectors configurable
N7551A	ECal economy, 2-ports	3.5 mm	DC to 6.5 GHz	Connectors configurable
N7552A	ECal economy, 2-ports	3.5 mm	DC to 9 GHz	Connectors configurable
N7553A	ECal economy, 2-ports	3.5 mm	DC to 14 GHz	Connectors configurable
N7554A	ECal economy, 2-ports	3.5 mm	DC to 18 GHz	Connectors configurable
N7555A	ECal economy, 2-ports	3.5 mm	DC to 26.5 GHz	Connectors configurable
2.92 mm (same as K connector)				
85561A	4-in-1 OSLT cal kit	2.92 mm (f)	DC to 40 GHz	Open, short, fixed load, thru (all female)
85562A	4-in-1 OSLT cal kit	2.92 mm (m)	DC to 40 GHz	Open, short, fixed load, thru (all male)
85056KE01 ³	Standard cal kit	2.92 mm	DC to 40 GHz	Open, short, fixed load, sliding load (both female and male)
85056KE02 ⁴	Economy cal kit	2.92 mm	DC to 40 GHz	Open, short, fixed load (both female and male)
N4692A	ECal	2.92 mm	10 MHz to 40 GHz	Connectors configurable

Model	Description	Connector	Frequency range	Components
2.4 mm				
85563A	3-in-1 OSL cal kit	2.4 mm (f)	DC to 50 GHz	Open, short, fixed load (all female)
85564A	3-in-1 OSL cal kit	2.4 mm (m)	DC to 50 GHz	Open, short, fixed load (all male)
85056D	Economy cal kit	2.4 mm	DC to 50 GHz	Open, short, fixed load (both female and male)
85056A	Standard cal kit	2.4 mm	DC to 50 GHz	Open, short, load, fixed load, sliding load (both female and male)
N4693A	ECal	2.4 mm	10 MHz to 50 GHz	Connectors configurable
Waveguide				
N9911X-11x	Econ. waveguide cal kit	WR-137	5.38 to 8.18 GHz	Short, termination, offset length
N9911 X-21x	Econ. waveguide cal kit	WR-90	8.2 to 12.5 GHz	Short, termination, offset length
N9911X-31x	Econ. waveguide cal kit	WR-62	11.9 to 18 GHz	Short, termination, offset length
N9911 X-41x	Econ. waveguide cal kit	WR-42	17.6 to 26.7 GHz	Short, termination, offset length
X11644A	Waveguide cal kit	WR-90	8.2 to 12.4 GHz	Short, shim, termination, standard section
P11644A	Waveguide cal kit	WR-62	12.4 to 18 GHz	Short, shim, termination, standard section
K11644A	Waveguide cal kit	WR-42	18 to 26.5 GHz	Short, shim, termination, standard section
R11644A	Waveguide cal kit	WR-28	26.5 to 40 GHz	Short, shim, termination two straight sections
Q11644A	Waveguide cal kit	WR-22	33 to 50 GHz	Short, shim, termination, two straight sections
U11644A	Waveguide cal kit	WR-19	40 to 60 GHz	Short, shim, termination, two straight sections

1. This calibration kit is not eligible for annual re-calibration. There are also no data report calibrations (UK6, 1A7 and A6J). If annual calibration is required, please order 85514A or 85515A.
2. Recommend ordering quantity 2 of N9910X Option 846, 50 to 75 Ω adapter.
3. Same as Maury's 8770C47.
4. Same as Maury's 8770D47.

Accessories

Cables					
All cables listed below are rugged phase-stable cables.					
Model	Cable connector	Other cable connector	Max frequency	Length (ft)	Length (m)
N9910X-700	Type-N (m)	Type-N (f)	18 GHz	3.28 ft	1 m
N9910X-701	Type-N (m)	Type-N (m)	18 GHz	3.28 ft	1 m
N9910X-704	Type-N (m)	TNC (f)	13 GHz	5 ft	1.5 m
N9910X-705	Type-N (m)	TNC (m)	13 GHz	5 ft	1.5 m
N9910X-708	3.5 mm (m)	3.5 mm (f)	26.5 GHz	3.28 ft	1 m
N9910X-709	3.5 mm (f)	3.5 mm (f)	26.5 GHz	3.28 ft	1 m
N9910X-714	2.4 mm (f)	2.4 mm (m)	50 GHz	3.28 ft	1 m
N9910X-715	2.4 mm (f)	2.4 mm (f)	50 GHz	3.28 ft	1 m
N9910X-716	Type-N (m)	Type-N (m)	18 GHz	2 ft	0.61 m
N9910X-718	2.4 mm (f)	K / 2.92 mm (m)	40 GHz	3.28 ft	1 m
N9910X-810	Type-N (m)	Type-N (m)	8 GHz	5 ft	1.5 m
N9910X-811	Type-N (m)	Type-N (f)	8 GHz	5 ft	1.5 m
N9910X-812	Type-N (m)	Type-N (m)	8 GHz	12 ft	3.6 m
N9910X-812	Type-N (m)	Type-N (f)	8 GHz	12 ft	3.6 m
N9910X-814	Type-N (m)	7/16 (m)	6 GHz	5 ft	1.5 m
N9910X-815	Type-N (m)	7/16 (m)	6 GHz	12 ft	3.6 m
N9910X-816	Type-N (m)	Type-N (f)	6 GHz	3.28 ft	1 m
N9910X-817	Type-N (m)	Type-N (m)	6 GHz	3.28 ft	1 m

Preamplifiers		
U7227A	USB preamplifier, 10 MHz to 4 GHz	www.keysight.com/find/U7227A
U7227C	USB preamplifier, 100 MHz to 26.5 GHz	www.keysight.com/find/U7227C
U7227F	USB preamplifier, 2 to 50 GHz	www.keysight.com/find/U7227F
U7228A	USB preamplifier, 10 MHz to 4 GHz	www.keysight.com/find/U7228A
U7228C	USB preamplifier, 100 MHz to 26.5 GHz	www.keysight.com/find/U7228C
U7228F	USB preamplifier, 2 to 50 GHz	www.keysight.com/find/U7228F

Noise sources	
346A/B/C/K01/K40	Noise source family www.keysight.com/find/346noisesources

Antennas	
N9910X-820	Antenna, directional, multiband, 800 to 2500 MHz, 10 dBi, Type-N (f)
N9910X-821	Antenna, telescopic whip, 70 MHz to 1 GHz, BNC (m)
N9910X-822	Antenna, directional, log periodic, 600 MHz to 9 GHz, Type-N (f)
N9910XA-823 ¹	Antenna, cellular narrowband, 824 to 869 MHz, Type-N (f)
N9910XA-824 ¹	Antenna, cellular narrowband, PCS 1850 to 1990 MHz, Type-N (f)
N9910X-825	Antenna, GPS, active, SMA (m)
85571A-028 ¹	5G Phased Array Antenna 28 GHz

1. Currently not RoHS compliant.

OML frequency extender modules			
<p>OML frequency extenders can be purchased directly through OML, Inc. One mixer, OML model number M28H2ADC-K (24 to 40 GHz), has been set up as a Keysight special handling part number N9910XM28-H2A for 3.5 mm test ports or N9910XM28-H2N for Type-N test ports and they are available for sale directly through Keysight. Contact OML, Inc. directly (www.omlinc.com) for pricing, ordering and datasheet information or contact a Keysight representative for assistance.</p> <p>FieldFox operating modes that support frequency extenders include: Spectrum analyzer, real-time spectrum analyzer, I/Q analyzer, over-the-air (LTE FDD, 5GTF), phased array antenna support and PathWave vector signal analysis software (formerly 89600 VSA).</p>			
OML model number	OML mixer frequency range	Frequency range with FieldFox models N9918/38A, N9917/37A, and N995x/6xA	Frequency range with FieldFox models N9916/36A
M28H2ADC-K ¹	24 to 40 GHz	24 to 40 GHz	24 to 34 GHz
M15H4ADC	50 to 75 GHz	50 to 75 GHz	50 to 62 GHz
M12H6ADC	60 to 90 GHz	60 to 90 GHz	60 to 90 GHz
M10H6ADC	75 to 110 GHz	75 to 110 GHz	75 to 90 GHz

1. Not applicable to N9951/61A and N9952/62A models with maximum frequency coverage of 44 and 50 GHz.

RF and microwave adapters	
83059A	Coaxial adapter, 3.5 mm (m) to 3.5 mm (m), 26.5 GHz
83059B	Coaxial adapter, 3.5 mm (f) to 3.5 mm (f), 26.5 GHz
83059C	Coaxial adapter, 3.5 mm (m) to 3.5 mm (f), 26.5 GHz
N9910X-601	Coaxial adapter, NMD 2.4 mm (f) to Type-N (f), 50-ohm, 18 GHz
N9910X-602	Coaxial adapter, NMD 2.4 mm (f) to 2.92 mm/K (f), 40 GHz
N9910X-603	Coaxial adapter, NMD 2.4 mm (f) to 3.5 mm (f), 26.5 GHz
N9910X-604	3.5 mm NMD (f) to 3.5 mm (f) adapter, 26.5 GHz
N9910X-605	3.5 mm NMD (f) to Type-N (f) adapter, 18 GHz
N9910X-843	Coaxial adapter, Type-N (m) to 7/16 DIN (f)
N9910X-845	Adapter kit: Type-N (f) to 7/16 DIN (f), Type-N (f) to 7/16 DIN (m), Type-N (f) to Type-N (f)
N9910X-846	Coaxial adapter, Type-N (m) 50 ohm to Type-N (f) 75 ohm
N9910X-847	Adapter kit: Type-N (f) to TNC (m) adapter, Type-N (f) to TNC (f) adapter, 11 GHz
N9910X-848	Coaxial adapter, Type-N (f) to 3.5 mm (f), 18 GHz
N9910X-849	Coaxial adapter, Type-N (f) to 3.5 mm (m), 18 GHz
N9910X-850	Coaxial adapter, Type-N (m) to Type-N (m), 18 GHz
N9910X-851	Coaxial adapter, Type-N (f) to Type-N (f), 18 GHz
N9910X-852	Coaxial adapter, Type-N (m) to Type-N (f), 18 GHz
N9910X-856	Coaxial adapter, 2.4 mm (f) to 2.4 mm (f), 50 GHz
N9910X-857	Coaxial adapter, 2.4 mm (f) to 2.92 mm/K (f), 40 GHz









Other RF and microwave accessories	
N9910X-860	Fixed attenuator, 40 dB, 100 W, DC to 3 GHz, Type-N (m) to Type-N (f)
N9910X-861	Fixed attenuator, 40 dB, 50 W, DC to 8.5 GHz, Type-N (m) to Type-N (f)
N9910X-874 ¹	External bias-tee, 2.5 MHz to 6 GHz, 1 W, 0.5 A
N9910X-886	Torque wrench, 17 mm, 90 N-cm (8 in-lb)
N9910X-712	Trig/Ref in Cable SMA (m) to BNC (f), 1 m or 3.28 ft
N9910X-713	Bias-tee power cable SMB (f) to BNC (m), 1 m or 3.28 ft

1. Also recommend ordering N9910X-713 Bias-Tee Power Cable, SMB(f) to BNC(m), 3.28 ft., to connect to the FieldFox DC bias variable voltage source port.

Other FieldFox accessories

N9910X-876	Extra high capacity battery
N9910X-872	External battery charger
N9910X-873	AC/DC adapter
N9910X-875	DC car charger and adapter
N9910X-880	Extra soft carrying case with backpack and shoulder strap
N9910X-881	Hard transit case
N9910X-886	Torque wrench, 17 mm, 90 N-cm (8 in-lb), recommended for N995xA and N996xA analyzers

Description	Accessory	Description	Accessory
N9910X-701 Type-N (m) to Type-N (m) cable, 3.28 ft		N9910X-812 Type-N (m) to Type-N (m) cable, 12 ft	
N9910X-708 3.5 mm (m) to 3.5 mm (f) cable, 3.28 ft		N9910X-816 Type-N (m) to Type-N (f) cable, 3.28 ft	
N9910X-820 Antenna, directional		N9910X-821 Antenna, telescopic whip™	
N9910XA-823 Antenna, cellular narrowband		N9910X-848 Coaxial adapter, Type-N(f) to 3.5 mm (f)	
N9910X-822 Antenna, directional		N9910X-875 DC car charger and adapter	
N9910X-825 Antenna, GPS, active		N9910X-873 AD/DC adapter	
N9910X-876 Extra high capacity battery		N9910X-874 External bias-tee	
N9910X-872 External battery charger		N4690B 2-port ECal, Type-N, 18 GHz	
N9910X-881 Hard transit case		N9910X-800 3-in-1 OSL cal kit, Type-N (m), 6 GHz	

Description	Accessory	Description	Accessory
N9910X-811 Type-N (m) to Type-N (f) cable, 5 ft		N991X0-801 3-in-1 OSL cal kit, Type-N (f), 6 GHz	
85514A 4-in-1 OSLT cal kit, Type-N (m) 9 GHz		85520A 4-in-1 OSLT cal kit, 3.5 mm (m), 26.5 GHz	
85515A 4-in-1 OSLT cal kit, Type-N (f), 9 GHz		85521A 4-in-1 OSLT cal kit, 3.5 mm (f), 26.5 GHz	
85518A 4-in-1 OSLT cal kit, Type-N (m), 18 GHz		85033D/E 3.5 mm cal kit, 9 GHz	
85519A 4-in-1 OSLT cal kit, Type-N (f), 18 GHz		85052D 3.5 mm cal kit, 26.5 GHz	
85054D Economy cal kit, Type-N, 18 GHz		N4691B 2-port ECal, 3.5 mm, 26.5 GHz	

Description	Accessory	Description	Accessory
N9911X-211/212/213/214 WR-90 economical cal kit		N4692A 2.92 mm, 2-port ECal, 40 GHz	
N4693A 2.4 mm 2-port ECal, 50 GHz		85056D 2.4 mm cal kit, 50 GHz	
X11644A WR-90 standard cal kit			

Learn more at: www.keysight.com

For more information on Keysight Technologies' products, applications or services, please contact your local Keysight office. The complete list is available at: www.keysight.com/find/contactus

