

# DATA SHEET

## METAL OXIDE VARISTORS POWER SUPPLY

20D series

RoHS compliant & Halogen free



Product specification— May 08, 2021 V.2



## Metal Oxide Varistor (MOV) Data Sheet

### Features

- Wide operating voltage ( $V_{1mA}$ ) range from 18V to 1800V
- Fast responding to transient over-voltage
- Large absorbing transient energy capability
- Low clamping ratio and no follow-on current
- Meets MSL level 1, per J-STD-020
- Operating Temperature:  $-40^{\circ}\text{C} \sim +105^{\circ}\text{C}$
- Storage Temperature:  $-40^{\circ}\text{C} \sim +125^{\circ}\text{C}$
- Safety certification: UL、CSA、VDE

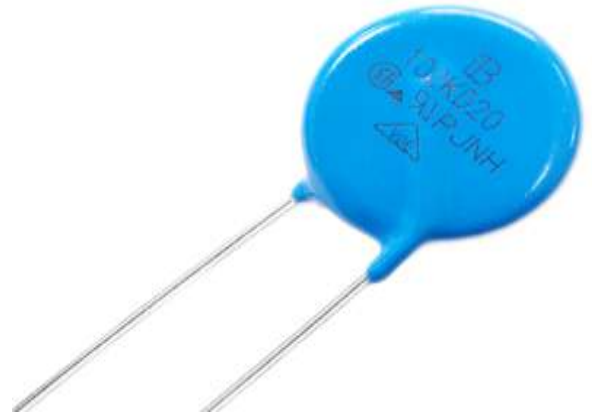

### Applications

- Transistor, diode, IC, thyristor or triac semiconductor protection
- Surge protection in consumer electronics
- Surge protection in industrial electronics
- Surge protection in electronic home appliances, gas and petroleum appliances
- Relay and electromagnetic valve surge absorption

### Part Number Code

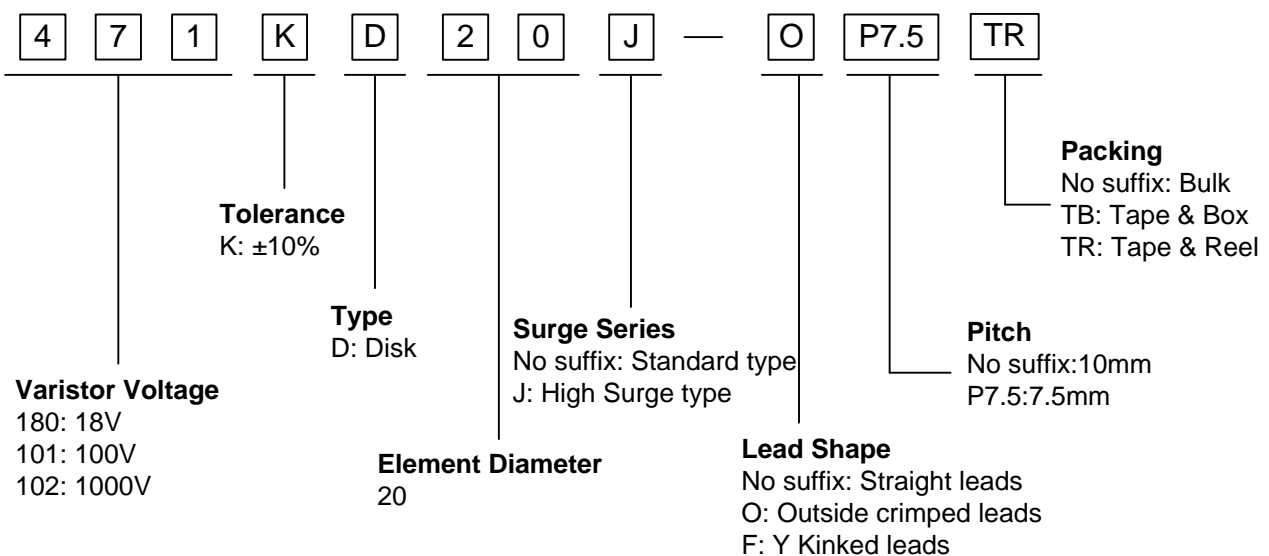

Dimensions

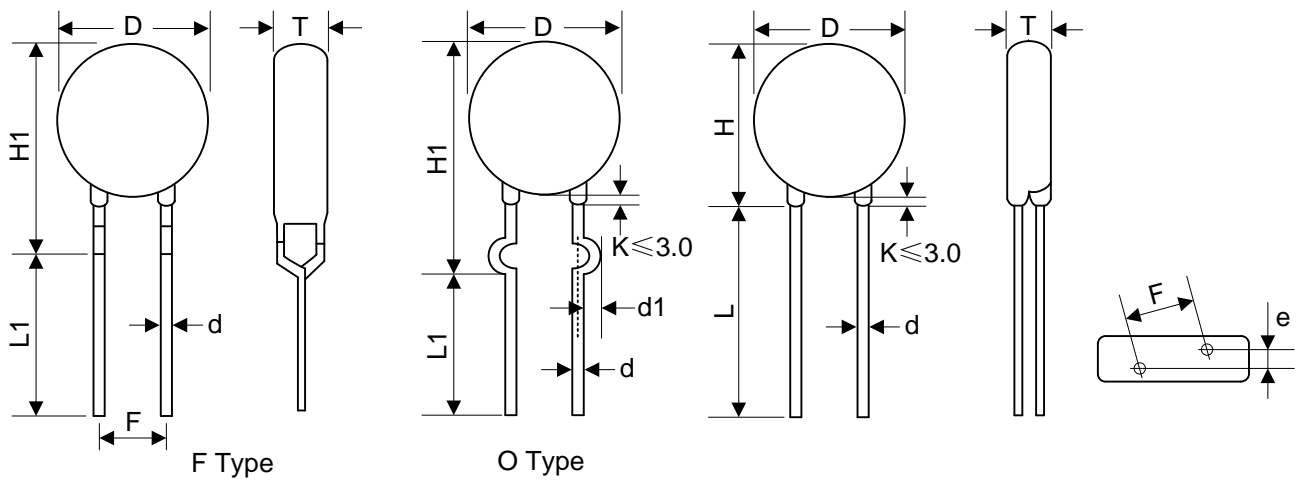

Notes: Varistor voltage  $\geq 1200V$ , structure diagram is F type.

Table 1	
Unit: mm	
Symbol	Dimension
H	21.0~26.0
H1	24.0~28.0
L(min.)	20.0
L1(min.)	15.0
D	20.0~23.0
F	7.5 $\pm$ 0.8/10.0 $\pm$ 1.0
T	Table 2
e( $\pm$ 0.8)	Table 2
d( $\pm$ 0.05)	0.8/1.0
d1( $\pm$ 0.4)	1.4/1.6

Table 2					
Unit: mm					
Model	T	e	Model	T	e
180K	2.1~4.3	1.7	361K	3.0~5.4	2.9
220K	2.2~4.4	1.8	391K	3.1~5.5	3.0
270K	2.2~4.6	2.0	431K	3.3~5.7	3.2
330K	2.3~4.8	1.9	471K	3.4~6.0	3.4
390K	2.2~4.5	2.0	511K	3.5~6.2	3.6
470K	2.3~4.7	2.1	561K	3.7~6.5	3.8
560K	2.4~5.0	2.3	621K	3.9~6.8	4.1
680K	2.5~5.3	2.6	681K	4.1~7.1	4.4
820K	2.2~4.5	2.0	751K	4.4~7.5	4.5
101K	2.5~4.6	2.2	781K	4.5~7.7	4.6
121K	2.5~4.8	2.4	821K	4.7~7.9	4.8
151K	2.3~4.5	2.0	911K	4.9~8.1	5.2
181K	2.4~4.6	2.1	102K	5.5~8.6	5.2
201K	2.5~4.7	2.2	112K	5.9~9.1	5.6
221K	2.6~4.8	2.3	122K	6.0~9.7	6.0
241K	2.7~4.9	2.4	142K	7.0~11.2	6.8
271K	2.7~5.0	2.6	162K	7.5~11.8	7.6
301K	2.8~5.0	2.7	182K	7.7~12.8	8.4
331K	2.8~5.2	2.7			

**Electrical Characteristics**

Part Number		Maximum Allowable Voltage		Varistor Voltage	Maximum Clamping Voltage		Withstanding Surge Current		Maximum Energy (10/1000µs)		Rated Power	Typical Capacitance (Reference)
Standard	High Surge	V <sub>AC</sub> (V)	V <sub>DC</sub> (V)	V <sub>1mA</sub> (V)	I <sub>p</sub> (A)	V <sub>c</sub> (V)	I (A) Standard	I (A) High Surge	(J) Standard	(J) High Surge	(W)	@1KHz (pf)
180KD20	180KD20J	11	14	18(15~21.6)	20	36	2000	3000	11	13	0.2	28500
220KD20	220KD20J	14	18	22(19.5~26)	20	43	2000	3000	14	16	0.2	18500
270KD20	270KD20J	17	22	27(24~31)	20	53	2000	3000	16	19	0.2	13000
330KD20	330KD20J	20	26	33(29.5~36.5)	20	65	2000	3000	23	24	0.2	11500
390KD20	390KD20J	25	31	39(35~43)	20	77	2000	3000	26	28	0.2	8500
470KD20	470KD20J	30	38	47(42~52)	20	93	2000	3000	30	34	0.2	7400
560KD20	560KD20J	35	45	56(50~62)	20	110	2000	3000	38	44	0.2	6500
680KD20	680KD20J	40	56	68(61~75)	20	135	2000	3000	41	49	0.2	5800
820KD20	820KD20J	50	65	82(74~90)	100	135	6500	10000	45	56	1.0	4900
101KD20	101KD20J	60	85	100(90~110)	100	165	6500	10000	50	70	1.0	4000
121KD20	121KD20J	75	100	120(108~132)	100	200	6500	10000	55	85	1.0	3300
151KD20	151KD20J	95	125	150(135~165)	100	250	6500	10000	70	106	1.0	2700
181KD20	181KD20J	115	150	180(162~198)	100	300	6500	10000	85	130	1.0	2200
201KD20	201KD20J	130	170	200(180~220)	100	340	6500	10000	95	140	1.0	2000
221KD20	221KD20J	140	180	220(198~242)	100	360	6500	10000	100	155	1.0	1800
241KD20	241KD20J	150	200	240(216~264)	100	395	6500	10000	108	168	1.0	1650
271KD20	271KD20J	175	225	270(243~297)	100	455	6500	10000	127	190	1.0	1500
301KD20	301KD20J	190	250	300(270~330)	100	500	6500	10000	136	210	1.0	1300
331KD20	331KD20J	210	275	330(297~363)	100	550	6500	10000	150	228	1.0	1200
361KD20	361KD20J	230	300	360(324~396)	100	595	6500	10000	163	255	1.0	1100
391KD20	391KD20J	250	320	390(351~429)	100	650	6500	10000	180	275	1.0	1000
431KD20	431KD20J	275	350	430(387~473)	100	710	6500	10000	190	305	1.0	930
471KD20	471KD20J	300	385	470(423~517)	100	775	6500	10000	204	350	1.0	850
511KD20	511KD20J	320	415	510(459~561)	100	845	6500	10000	210	360	1.0	780
561KD20	561KD20J	350	460	560(504~616)	100	925	6500	10000	215	380	1.0	710
621KD20	621KD20J	385	505	620(558~682)	100	1025	6500	10000	224	390	1.0	650
681KD20	681KD20J	420	560	680(612~748)	100	1120	6500	10000	230	400	1.0	600
751KD20	751KD20J	460	615	750(675~825)	100	1240	6500	10000	255	420	1.0	530
781KD20	781KD20J	485	640	780(702~858)	100	1290	6500	10000	265	440	1.0	510
821KD20	821KD20J	510	670	820(738~902)	100	1355	6500	10000	282	460	1.0	500
911KD20	911KD20J	550	745	910(819~1001)	100	1500	6500	10000	310	510	1.0	440
102KD20	102KD20J	625	825	1000(900~1100)	100	1650	6500	10000	342	565	1.0	400
112KD20	112KD20J	680	895	1100(990~1210)	100	1815	6500	10000	383	620	1.0	360
122KD20	122KD20J	750	990	1200(1080~1320)	100	1980	6500	10000	408	660	1.0	350
142KD20	142KD20J	880	1140	1400(1260~1540)	100	2310	6500	10000	532	784	1.0	340
162KD20	162KD20J	1000	1280	1600(1440~1760)	100	2640	6500	10000	606	896	1.0	330
182KD20	182KD20J	1100	1465	1800(1620~1980)	100	2970	6500	10000	625	990	1.0	320

- Notes: 1. The tolerance of varistor voltage between 18V and 27V is more than 10%;  
 2. Varistor voltage ≥ 1200V, structure diagram is F type;  
 3. Leakage Current (@83% of V<sub>1mA</sub>): IR ≤ 50µA (180K~680K) ; IR ≤ 25µA (820K~182K).

**Maximum Surge Current Derating Curve**

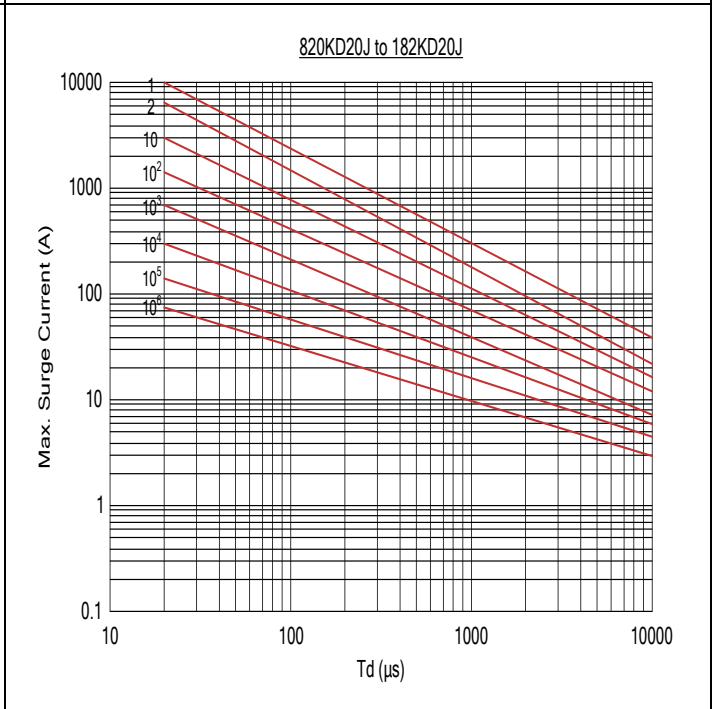
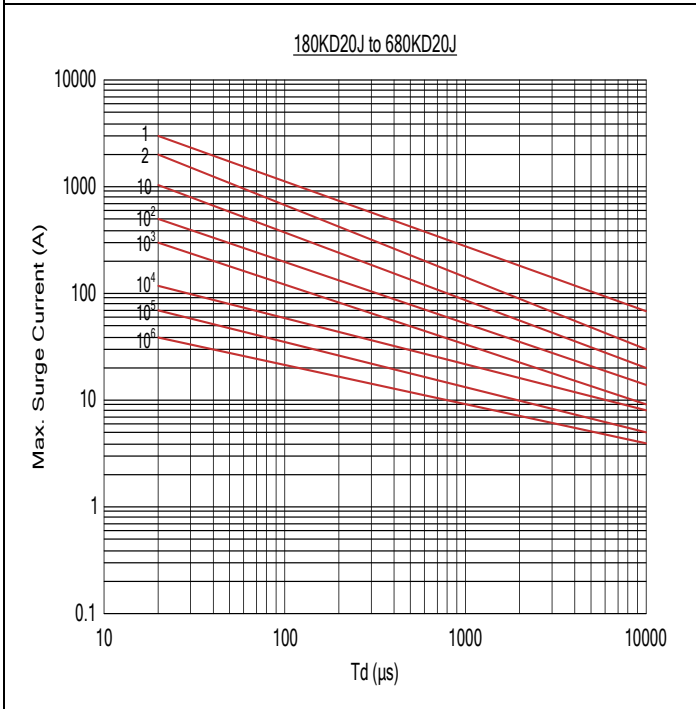
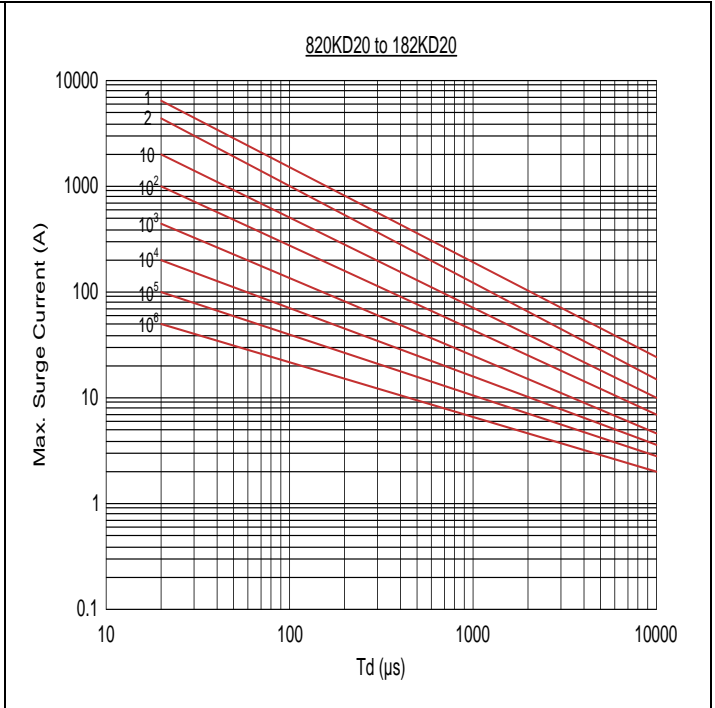
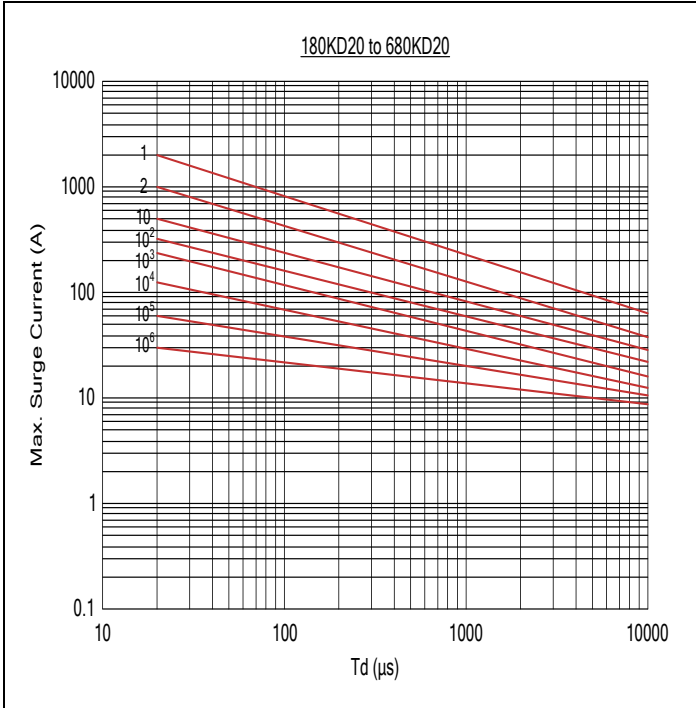

**Maximum Leakage Current and Maximum Clamping Voltage Curve**

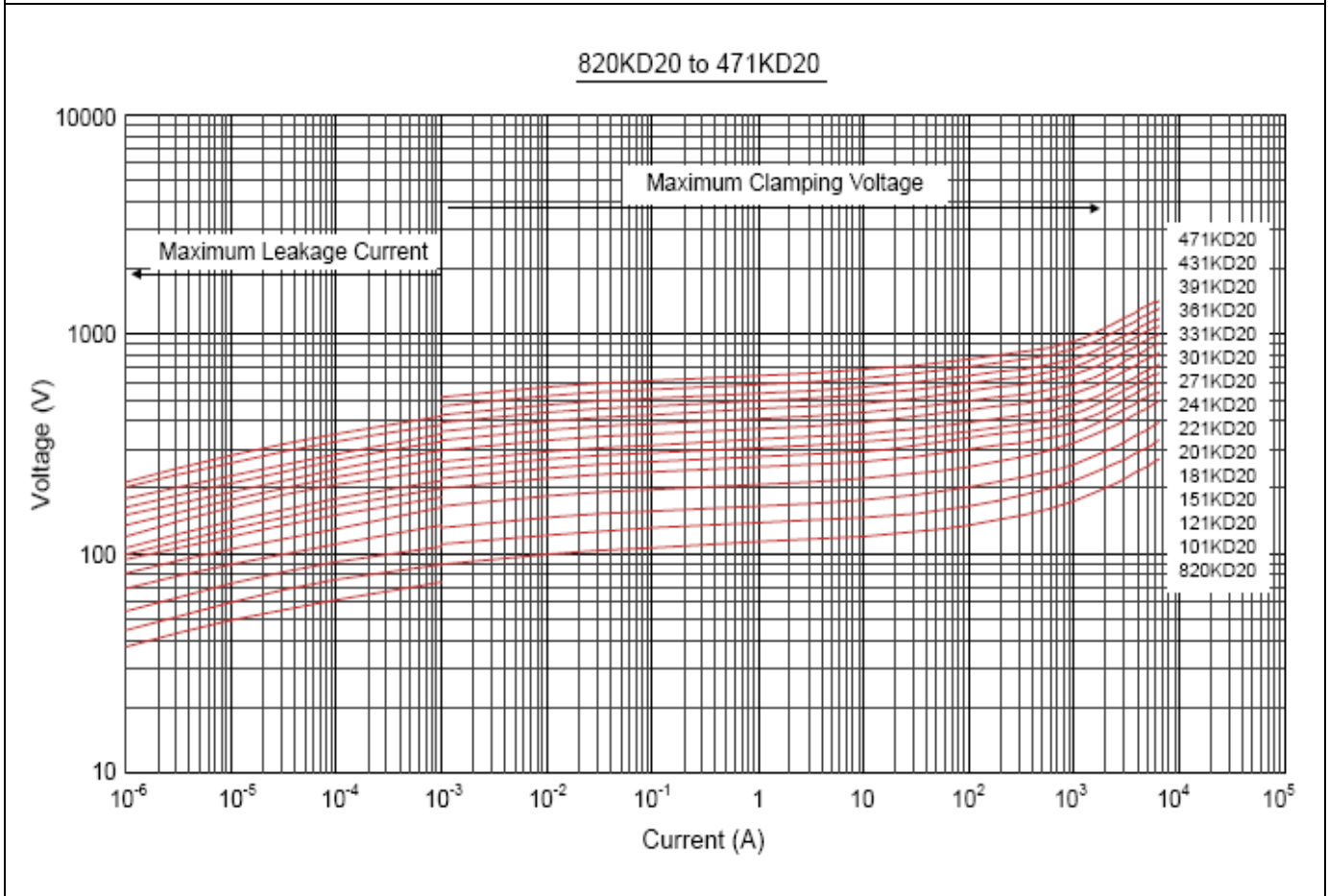
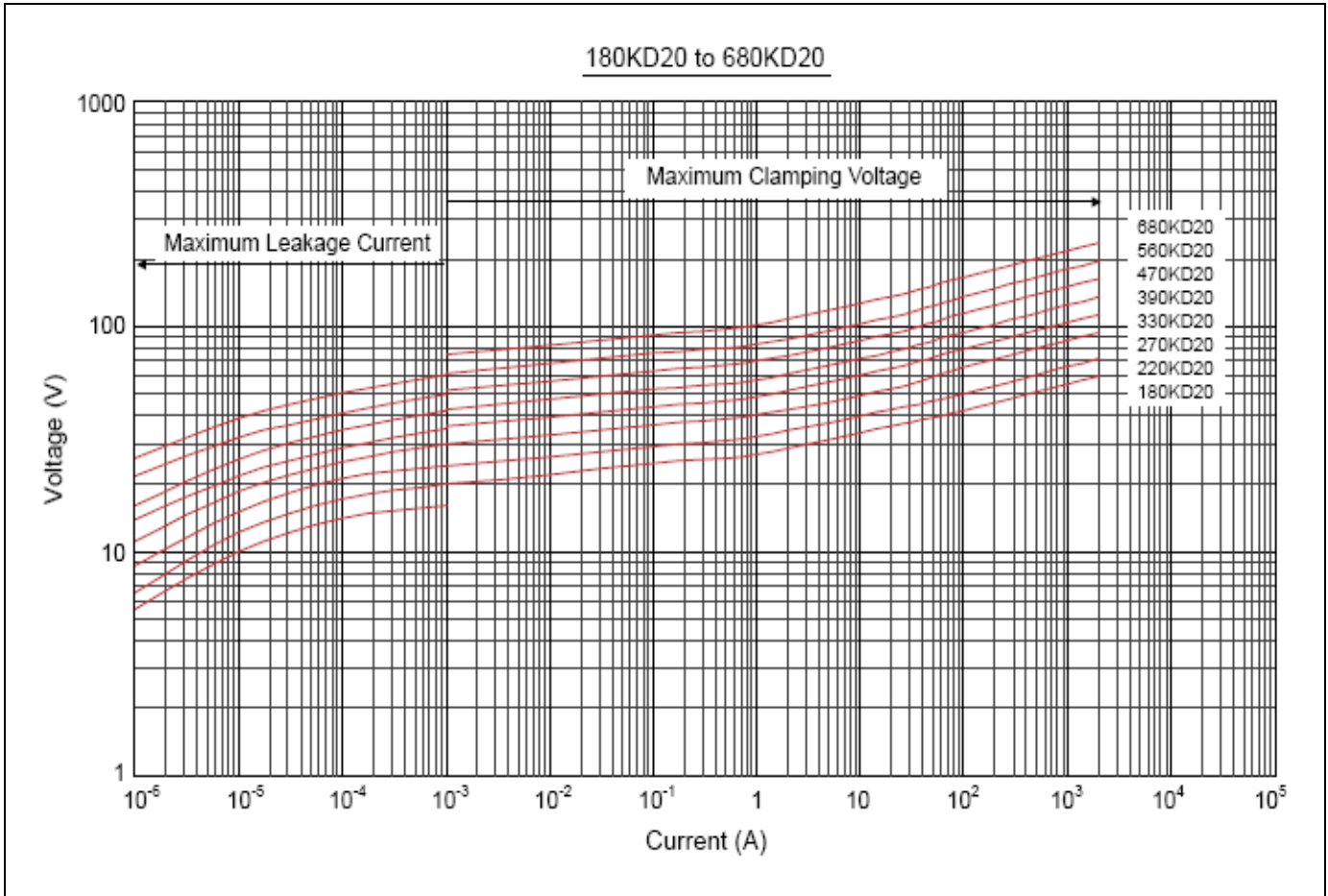

**Maximum Leakage Current and Maximum Clamping Voltage Curve**

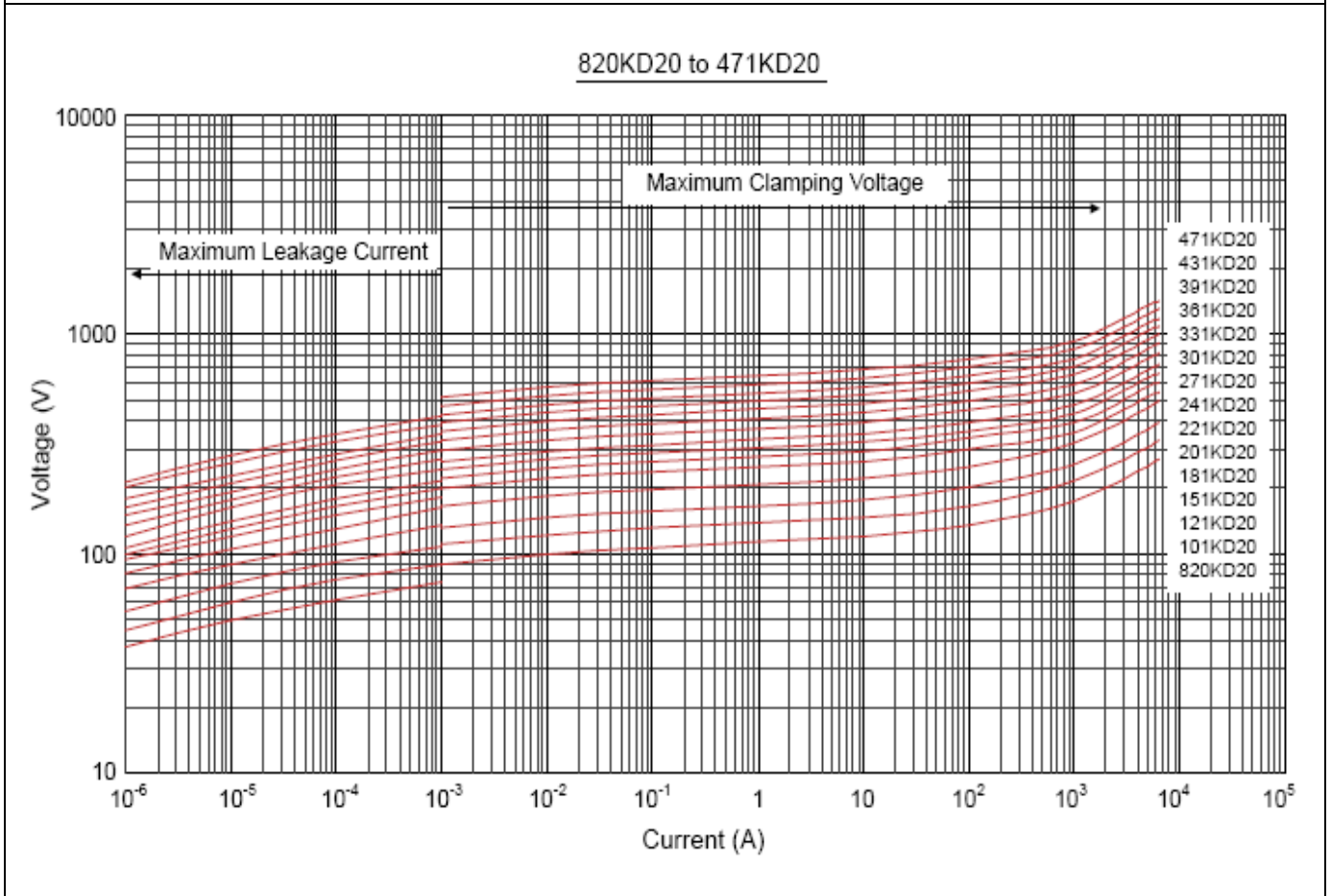
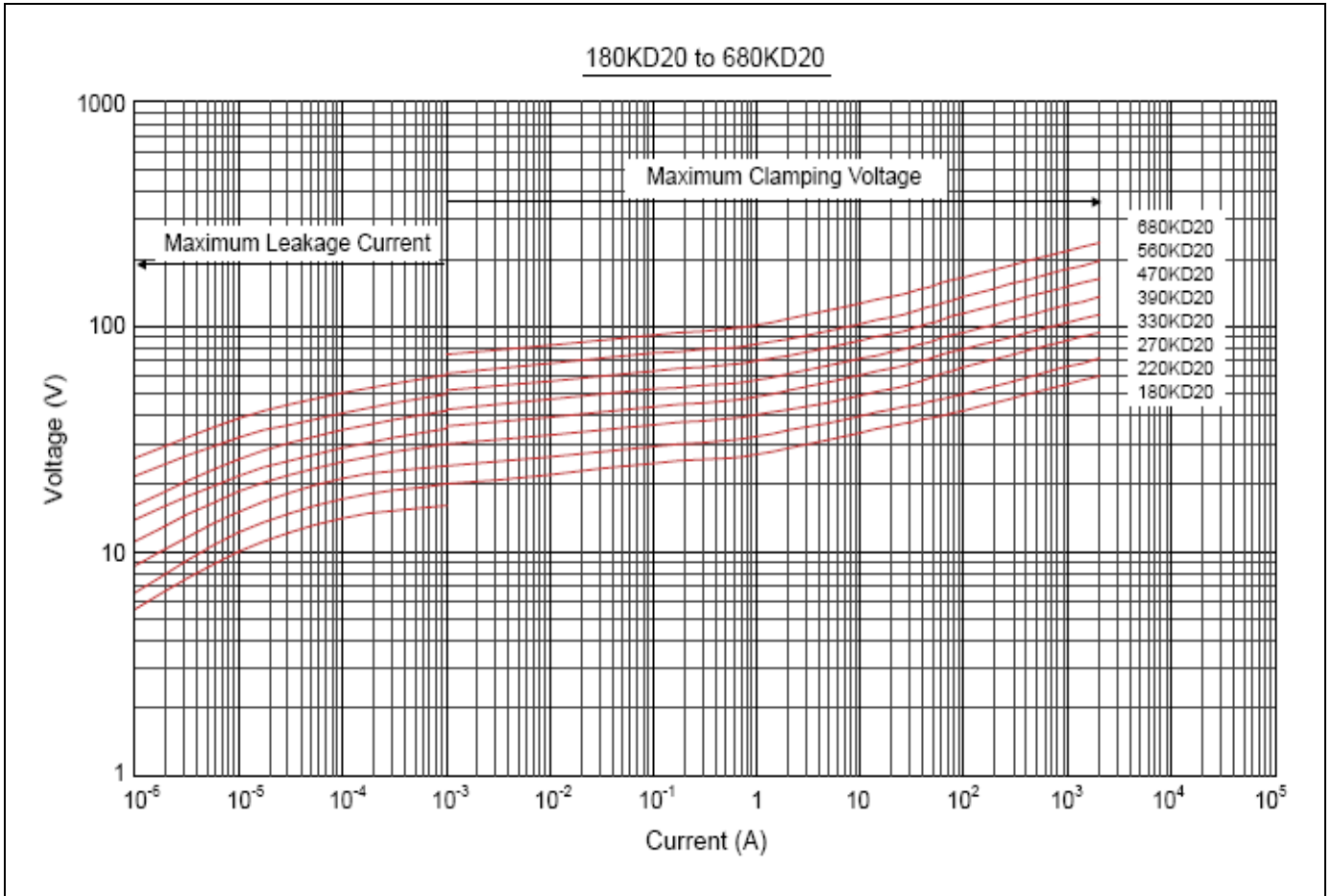

Maximum Leakage Current and Maximum Clamping Voltage Curve

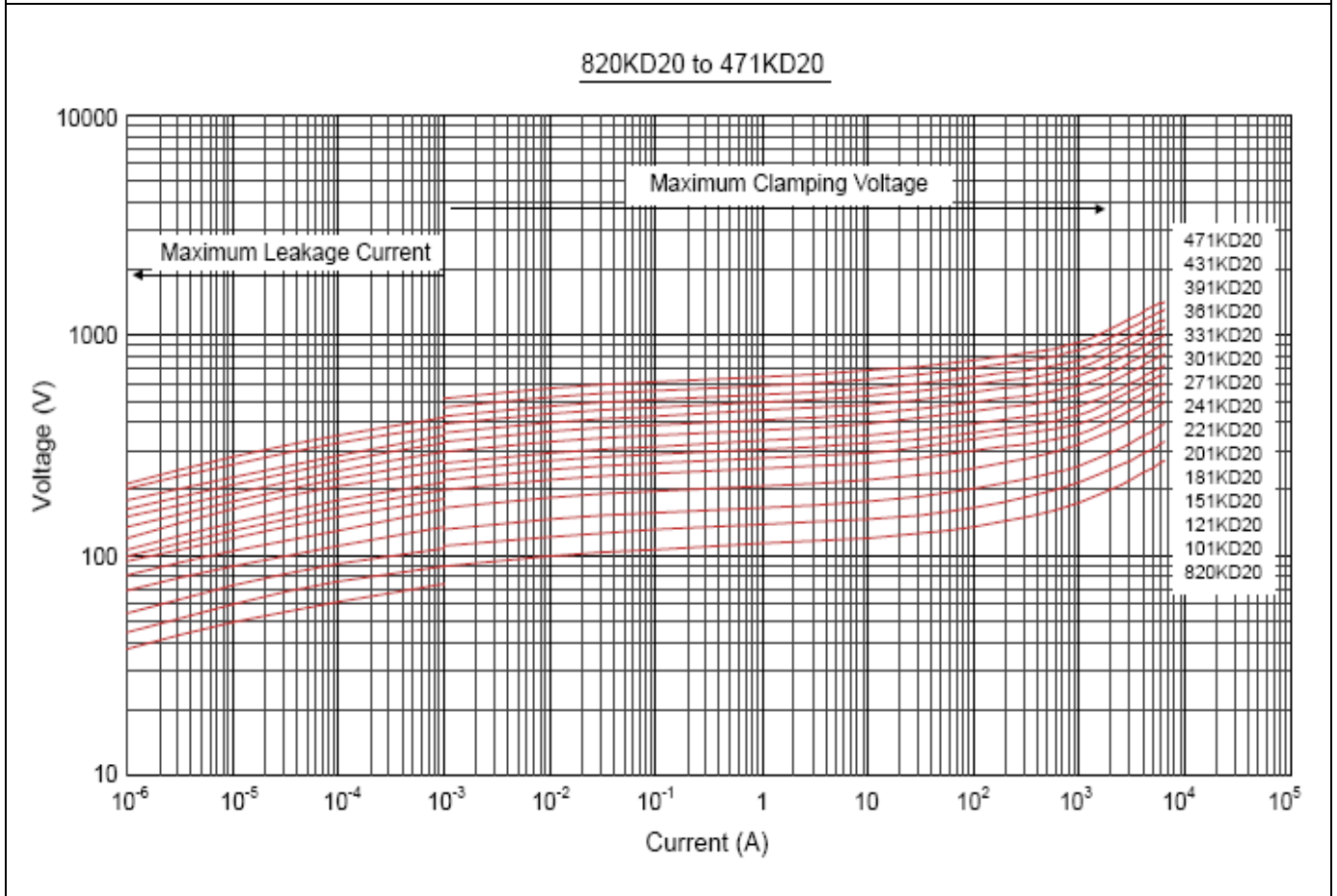
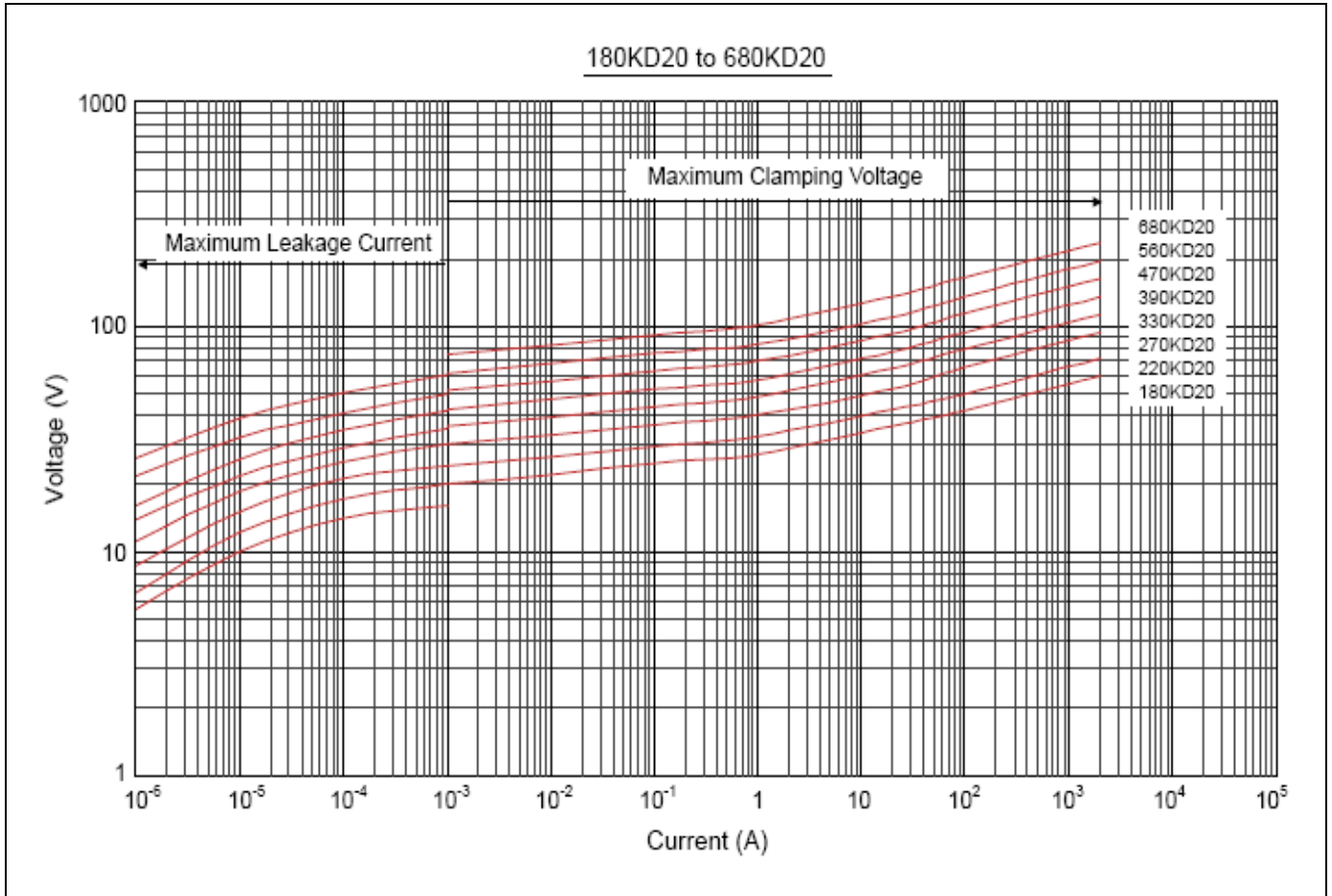



**Reliability**

Items	Standard	Test conditions / Methods	Specifications															
Tensile Strength of Terminals	IEC60068-2-21	Gradually applying the force specified and keeping the unit fixed for 10±1 sec.  <table border="1" style="margin-left: auto; margin-right: auto;"> <thead> <tr> <th>Terminal diameter (mm)</th> <th>Force (kg)</th> </tr> </thead> <tbody> <tr> <td>0.5 &lt; d ≤ 0.8</td> <td>1.0</td> </tr> <tr> <td>0.8 &lt; d ≤ 1.25</td> <td>2.0</td> </tr> <tr> <td>1.25 &lt; d</td> <td>4.0</td> </tr> </tbody> </table>	Terminal diameter (mm)	Force (kg)	0.5 < d ≤ 0.8	1.0	0.8 < d ≤ 1.25	2.0	1.25 < d	4.0	No visible damage  ΔV <sub>1mA</sub> /V <sub>1mA</sub>   ≤ 5%							
Terminal diameter (mm)	Force (kg)																	
0.5 < d ≤ 0.8	1.0																	
0.8 < d ≤ 1.25	2.0																	
1.25 < d	4.0																	
Bending Strength of Terminals	IEC60068-2-21	Hold specimen and apply the force specified below to each lead. Bend the specimen to 90°, then return to the original position. Repeat the procedure in the opposite direction.  <table border="1" style="margin-left: auto; margin-right: auto;"> <thead> <tr> <th>Terminal diameter (mm)</th> <th>Force (kg)</th> </tr> </thead> <tbody> <tr> <td>0.5 &lt; d ≤ 0.8</td> <td>0.5</td> </tr> <tr> <td>0.8 &lt; d ≤ 1.25</td> <td>1.0</td> </tr> <tr> <td>1.25 &lt; d</td> <td>2.0</td> </tr> </tbody> </table>	Terminal diameter (mm)	Force (kg)	0.5 < d ≤ 0.8	0.5	0.8 < d ≤ 1.25	1.0	1.25 < d	2.0	No visible damage  ΔV <sub>1mA</sub> /V <sub>1mA</sub>   ≤ 5%							
Terminal diameter (mm)	Force (kg)																	
0.5 < d ≤ 0.8	0.5																	
0.8 < d ≤ 1.25	1.0																	
1.25 < d	2.0																	
Vibration	IEC60068-2-6	Frequency range: 10~55 Hz Amplitude: 0.75mm or 98m/s <sup>2</sup> Direction: 3 mutually perpendicular directions, 2hrs each.	No visible damage  ΔV <sub>1mA</sub> /V <sub>1mA</sub>   ≤ 5%															
Solderability	IEC60068-2-20	Solder Temp: 245±5°C Dipping Time: 2±0.5 sec	At least 95% of terminal electrode is covered by new solder															
Resistance to Soldering Heat	IEC60068-2-20	Solder Temp: 260±5°C Dipping Time: 10±1 sec	No visible damage  ΔV <sub>1mA</sub> /V <sub>1mA</sub>   ≤ 5%															
High Temperature Storage	IEC60068-2-2	Ambient Temp: 125±2°C Duration: 1000±24hrs	No visible damage  ΔV <sub>1mA</sub> /V <sub>1mA</sub>   ≤ 5%															
Low Temperature Storage	IEC60068-2-1	Ambient Temp: -40±2°C Duration: 1000±24hrs	No visible damage  ΔV <sub>1mA</sub> /V <sub>1mA</sub>   ≤ 5%															
Damp Heat, Steady State	IEC60068-2-78	The test is divided into two groups . a. 40±2°C , 90~95% RH for 1344±24hrs b. 40±2°C , 90~95% RH, at 10%VDC , 1344±24 hrs	No visible damage  ΔV <sub>1mA</sub> /V <sub>1mA</sub>   ≤ 10% Insulation Resistance ≥ 100MΩ															
High Temperature Load	MIL-STD-202 Method 108	Ambient Temp: 105±2°C    Duration: 1000±24hrs Load: Max. Allowable Voltage In AC.	ΔV <sub>1mA</sub> /V <sub>1mA</sub>   ≤ 10%															
Temperature Cycle	IEC60068-2-14	The conditions shown below shall be repeated 5 cycles <table border="1" style="margin-left: auto; margin-right: auto;"> <thead> <tr> <th>Step</th> <th>Temperature (°C)</th> <th>Period (minutes)</th> </tr> </thead> <tbody> <tr> <td>1</td> <td>-40±3</td> <td>30±3</td> </tr> <tr> <td>2</td> <td>Room temperature</td> <td>5±3</td> </tr> <tr> <td>3</td> <td>125±3</td> <td>30±3</td> </tr> <tr> <td>4</td> <td>Room temperature</td> <td>5±3</td> </tr> </tbody> </table>	Step	Temperature (°C)	Period (minutes)	1	-40±3	30±3	2	Room temperature	5±3	3	125±3	30±3	4	Room temperature	5±3	No visible damage  ΔV <sub>1mA</sub> /V <sub>1mA</sub>   ≤ 5%
Step	Temperature (°C)	Period (minutes)																
1	-40±3	30±3																
2	Room temperature	5±3																
3	125±3	30±3																
4	Room temperature	5±3																
8/20uS Surge Life	IEC61051-1	8/20μS waveform, 10 surge currents, unipolar, interval 30secs, amplitude corresponding to max. surge current derating curves for 20μS.	No visible damage ΔV <sub>b</sub> (1mA) ≤ ±10%															
10/1000μS Surge Life	IEC61051-1	10/1000μS waveform, 10 surge currents, unipolar, interval 2mins, amplitude corresponding to max. surge current derating curves for 1000μS.	No visible damage  ΔV <sub>1mA</sub> /V <sub>1mA</sub>   ≤ 10%															
Voltage Proof	IEC61051-1	Metal balls method, 2500Vac 1 min.	No visible damage															

**Soldering Recommendation**

Lead-free Wave Soldering Recommendation

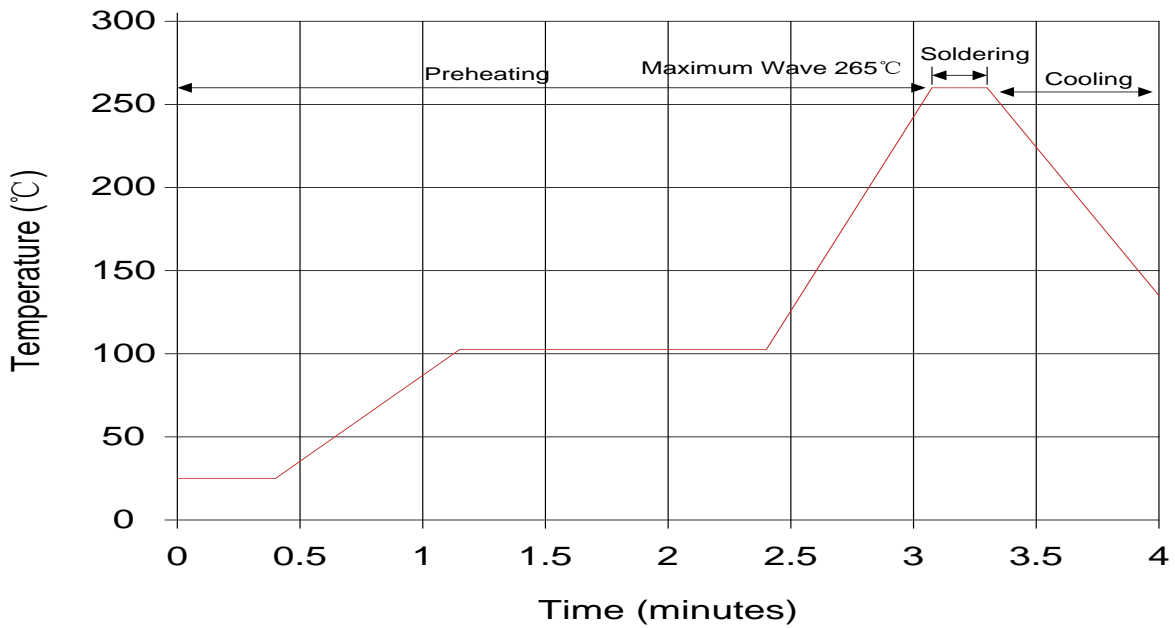

Item	Conditions
Peak Temperature	265°C
Dipping Time	10 seconds (max.)
Soldering	1 time

Recommendation Reworking Conditions with Soldering Iron

Item	Conditions
Temperature of Soldering Iron-tip	360°C (max.)
Soldering Time	3 seconds (max.)
Distance from Varistor	2mm (min.)

**Marking Code**

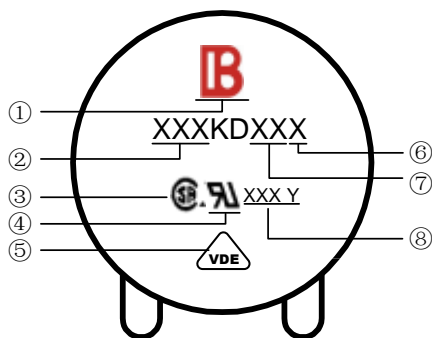

- ① Brightking Logo
- ② Varistor Voltage
- ③ CSA Accreditation Logo
- ④ UL Accreditation Logo
- ⑤ VDE Accreditation Logo
- ⑥ “J” is High Surge Code, no “J” is Standard Surge
- ⑦ Disk Size
- ⑧ Internal control code

**Taping Dimensions**

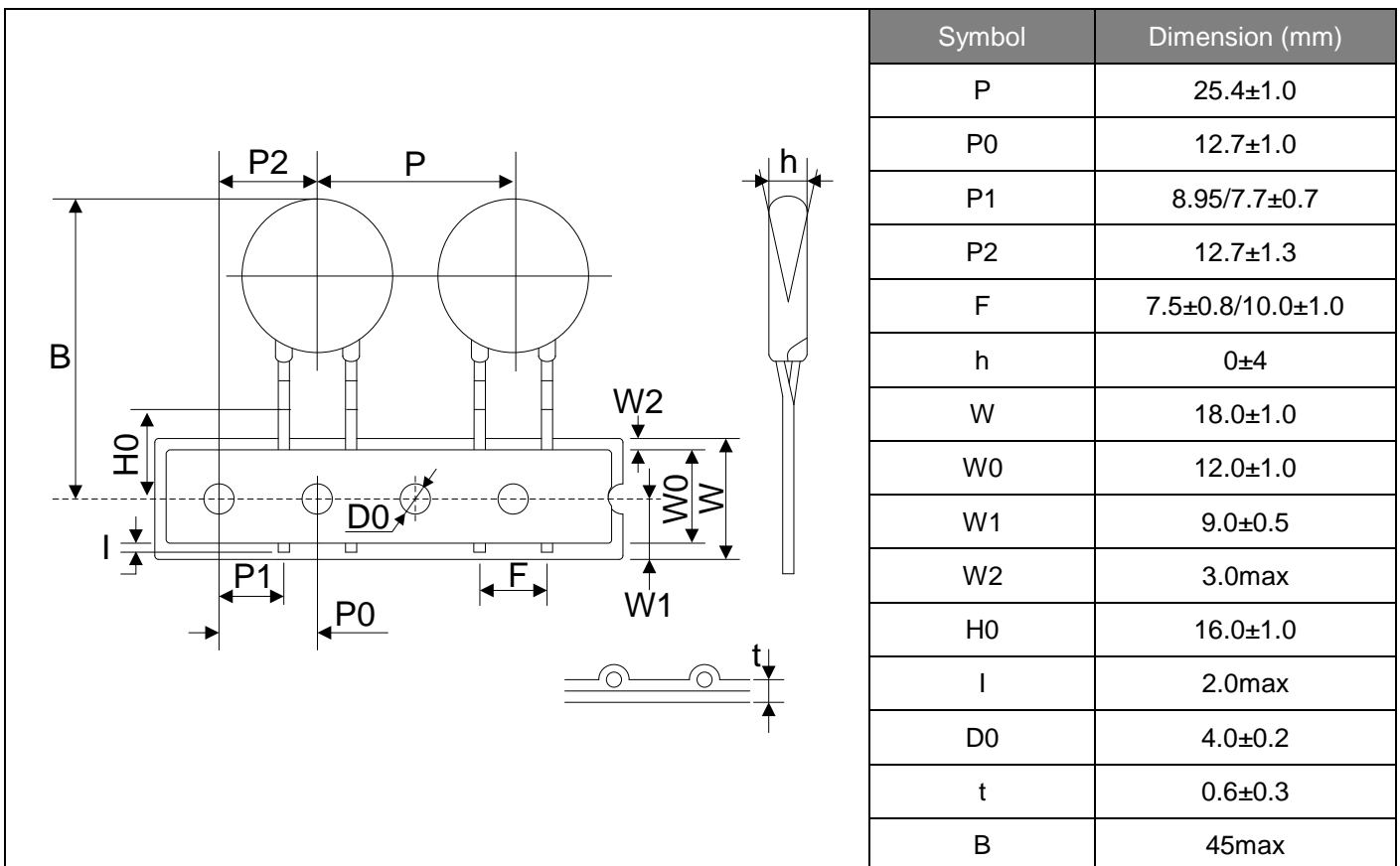
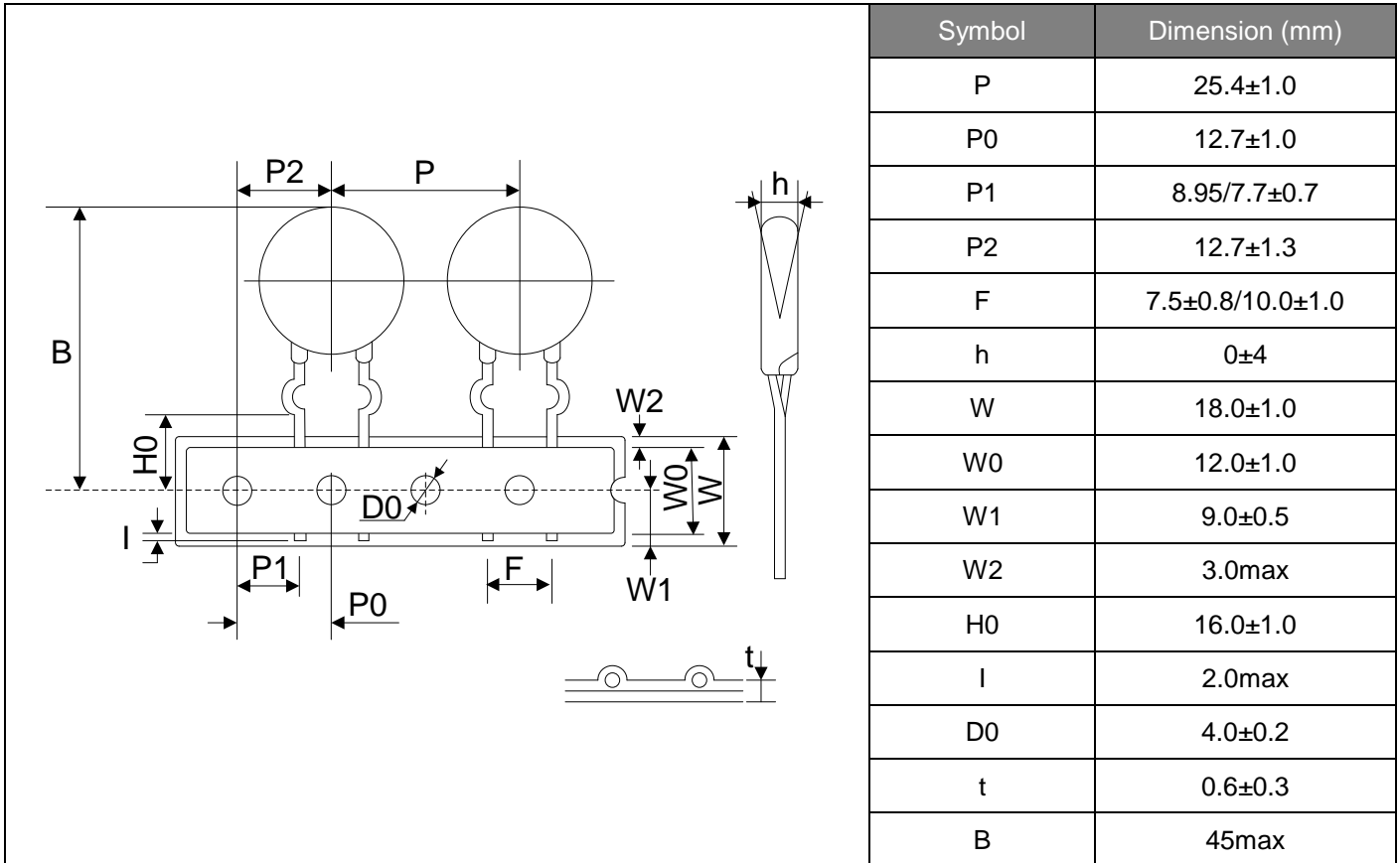

**Taping Dimensions**

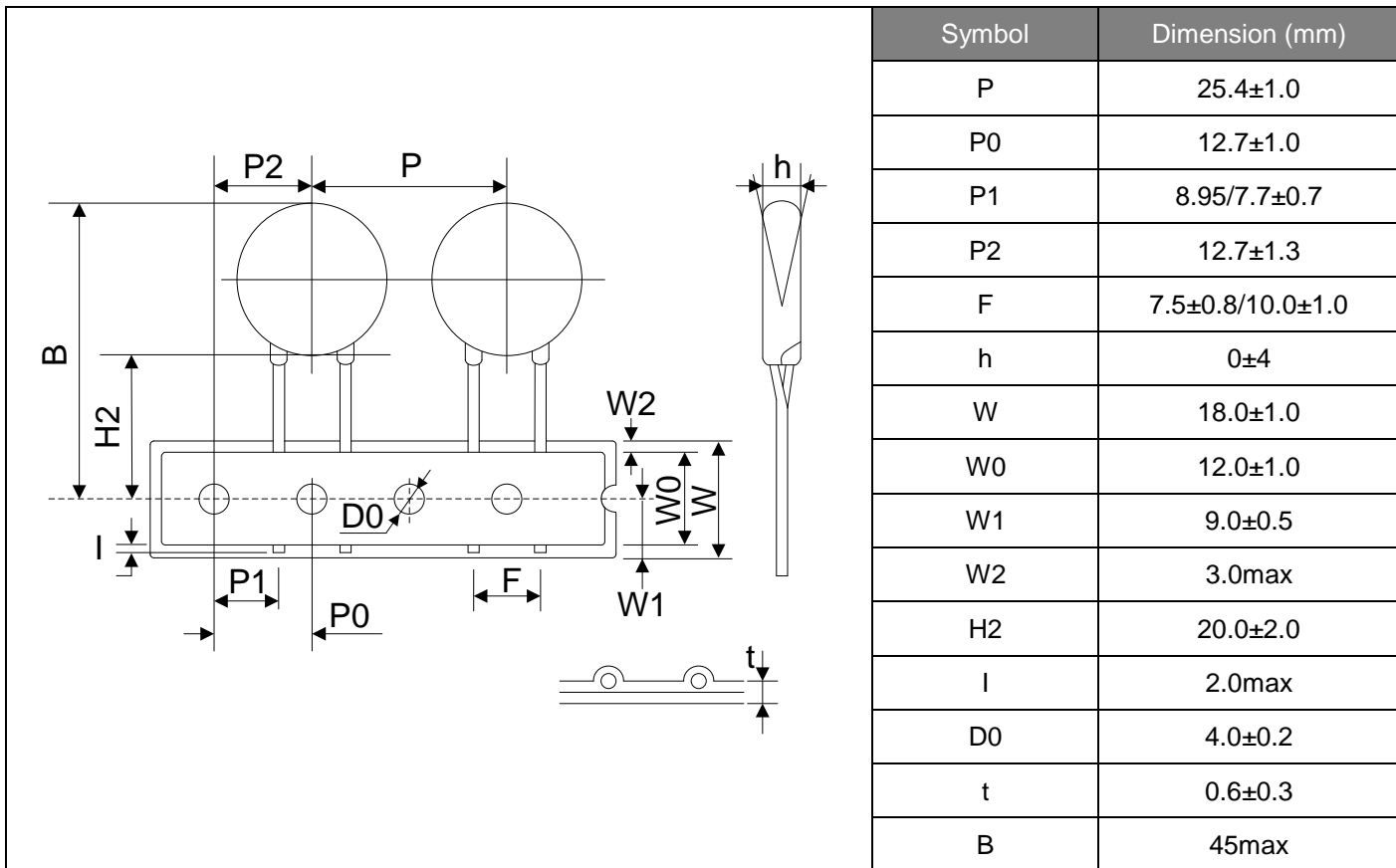

**Quantit**

Packaging Dimensions (Unit: mm)	Quantity
<p>In bulk for Terminals Untrimmed Products</p>	400pcs/bag 4bags/box (180K~331K)
	300pcs/bag 4bags/box (361K~621K)
	250pcs/bag 4bags/box (681K~112K)
	150pcs/bag 4bags/box (122K~182K)

**Quantit**

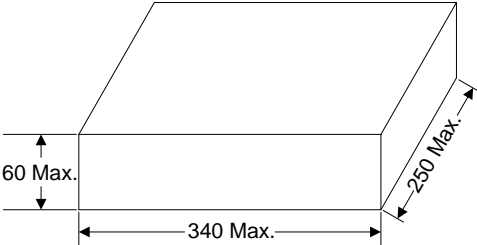
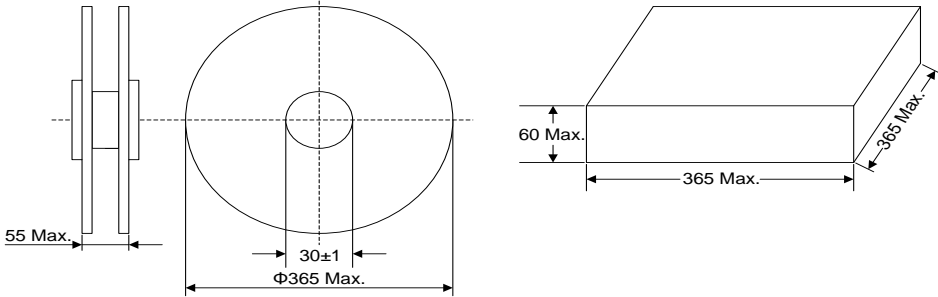
Packaging Dimensions (Unit: mm)	Quantity
<p>In bulk for Terminals Trimmed Products</p> 	<p>250pcs/bag 2bags/box (180K~301K)</p> <p>200pcs/bag 2bags/box (331K~561K)</p> <p>150pcs/bag 2bags/box (621K~112K)</p> <p>100pcs/bag 2bags/box (122K~182K)</p>
Packaging Dimensions (Unit: mm)	Quantity
<p>Tape &amp; Box &amp; P0=12.7mm</p> 	<p>400pcs/box (180K~301K)</p> <p>300pcs/box (331K~561K)</p>
<p>Tape &amp; Reel &amp; P0=12.7mm</p> 	<p>400pcs/box (180K~301K)</p> <p>300pcs/box (331K~561K)</p>

## Storage Condition of Products

### (I) Storage Conditions :

- 1.Storage Temperature :  $-10^{\circ}\text{C} \sim +40^{\circ}\text{C}$
- 2.Relative Humidity :  $\leq 80\%RH$
- 3.Keep away from corrosive atmosphere and sunlight.

### (II) Period of Storage : 1 year