

Power SMD LED CLCC-6 Flat



20832

DESCRIPTION

The VLMK/Y62.. is one of the most robust and light efficient LEDs in the market. Its ceramic package makes it the ideal light source in applications of high thermal considerations allowing the additional current drive for a maximum light output while maintaining a high service life of up to 50K h.

PRODUCT GROUP AND PACKAGE DATA

- Product group: LED
- Package: SMD CLCC-6 flat
- Product series: power
- Angle of half intensity: $\pm 60^\circ$

FEATURES

- Utilizing AlInGaP technology
- Very low thermal resistance
- Optical efficiency 35 lm/W
- Luminous intensity and color grouping
- Luminous intensity ratio per package unit
 $I_{Vmax}/I_{Vmin} \leq 1.6$
- ESD-withstand voltage:
up to 2 kV according to JESD22-A114-B
- Compatible with IR-reflow solder processes according to CECC 00802 and J-STD-020C
- Lead (Pb)-free device
- Component in accordance to RoHS 2002/95/EC and WEEE 2002/96/EC
- Preconditioning: acc. to JEDEC level 4
- Automotive qualified AEC-Q101
- Very flat package (0.9 mm)



APPLICATIONS

- Backlighting
(LCDs, switches, keys, illuminated advertising)
- Exterior automotive lighting:
(brake lights, turn lights, backlighting)
- Signal and symbol luminaire
- Marker lights
- Traffic lights
- Side markers

PARTS TABLE

PART	COLOR, LUMINOUS INTENSITY (at $I_F = 140$ mA)	LUMINOUS FLUX (TYP)	TECHNOLOGY
VLMK62CADA-GS08	Amber, $I_V = (2800 \text{ to } 5600)$ mcd	14100 mlm	AlInGaP
VLMK62CADA-GS18	Amber, $I_V = (2800 \text{ to } 5600)$ mcd	14100 mlm	AlInGaP
VLMY62CADA-GS08	Yellow, $I_V = (2800 \text{ to } 5600)$ mcd	14100 mlm	AlInGaP
VLMY62CADA-GS18	Yellow, $I_V = (2800 \text{ to } 5600)$ mcd	14100 mlm	AlInGaP

ABSOLUTE MAXIMUM RATINGS ¹⁾ VLMK62../VLMY62..				
PARAMETER	TEST CONDITION	SYMBOL	VALUE	UNIT
Forward current		I_F	150	mA
Power dissipation		P_{tot}	450	mW
Junction temperature		T_j	+ 115	°C
Surge current $t < 10 \mu\text{s}$, $d = 0.1$		I_{FM}	1000	mA
Operating temperature range		T_{amb}	- 40 to + 100	°C
Storage temperature range		T_{stg}	- 40 to + 100	°C
Thermal resistance junction/pin	Metal core pcb 960 mm ² per LED	R_{thJP}	60	K/W
Thermal resistance junction/ambient		R_{thJA}	110	K/W

Note:

Not designed for reverse operation

¹⁾ $T_{amb} = 25 \text{ °C}$, unless otherwise specified

OPTICAL AND ELECTRICAL CHARACTERISTICS ¹⁾ VLMY62CADA, YELLOW						
PARAMETER	TEST CONDITION	SYMBOL	MIN	TYP.	MAX	UNIT
Luminous intensity	$I_F = 140 \text{ mA}$	I_V	2800		5600	mcd
Luminous flux	$I_F = 140 \text{ mA}$	ϕ_V	8800	14100	17600	mlm
Dominant wavelength	$I_F = 140 \text{ mA}$	λ_d	583		594	nm
Peak wavelength	$I_F = 140 \text{ mA}$	λ_p		591		nm
Spectral bandwidth at 50 % $I_{rel \text{ max}}$	$I_F = 140 \text{ mA}$	$\Delta\lambda$		15		nm
Angle of half intensity	$I_F = 140 \text{ mA}$	ϕ		± 60		deg
Forward voltage	$I_F = 140 \text{ mA}$	V_F	1.90	2.4	3.0	V
Optical efficiency	$I_F = 140 \text{ mA}$	η_{opt}		29		lm/W

Note:

¹⁾ $T_{amb} = 25 \text{ °C}$, unless otherwise specified

OPTICAL AND ELECTRICAL CHARACTERISTICS ¹⁾ VLMK62CADA, AMBER						
PARAMETER	TEST CONDITION	SYMBOL	MIN	TYP.	MAX	UNIT
Luminous intensity	$I_F = 140 \text{ mA}$	I_V	2800		5600	mcd
Luminous flux	$I_F = 140 \text{ mA}$	ϕ_V	8800	14100	17600	mlm
Dominant wavelength	$I_F = 140 \text{ mA}$	λ_d	612		624	nm
Peak wavelength	$I_F = 140 \text{ mA}$	λ_p		611		nm
Spectral bandwidth at 50 % $I_{rel \text{ max}}$	$I_F = 140 \text{ mA}$	$\Delta\lambda$		18		nm
Angle of half intensity	$I_F = 140 \text{ mA}$	ϕ		60		deg
Forward voltage ²⁾	$I_F = 140 \text{ mA}$	V_F	1.90	2.4	3.0	V
Optical efficiency	$I_F = 140 \text{ mA}$	η_{opt}		29		lm/W

Note:

¹⁾ $T_{amb} = 25 \text{ °C}$, unless otherwise specified

²⁾ Forward voltages are tested at a current pulse duration of 1 ms and a tolerance of $\pm 0.05 \text{ V}$



LUMINOUS INTENSITY/FLUX CLASSIFICATION YELLOW/AMBER			
GROUP	LUMINOUS INTENSITY IV (MCD)		LUMINOUS FLUX Φ V (MLM)
STANDARD	MIN	MAX	TYP.
CA	2800	3550	9500
CB	3550	4500	12000
DA	4500	5600	15000

Note:

Luminous intensity is tested at a current pulse duration of 25 ms and an accuracy of $\pm 11\%$.

The above type Numbers represent the order groups which include only a few brightness groups. Only one group will be shipped on each reel (there will be no mixing of two groups on each reel).

In order to ensure availability, single brightness groups will not be orderable.

In a similar manner for colors where wavelength groups are measured and binned, each single wavelength group is packed in a single reel.

In order to ensure availability, single wavelength groups can not be ordered.

COLOR CLASSIFICATION				
GROUP	DOM. WAVELENGTH (NM)			
	YELLOW		AMBER	
	MIN.	MAX.	MIN.	MAX.
1	581	584		
2	583	586	612	616
3	585	588	616	620
4	587	590	620	624
5	589	592		
6	591	594		

Note:

Wavelengths are tested at a current pulse duration of 25 ms and an accuracy of ± 1 nm.

FORWARD VOLTAGE CLASSIFICATION		
GROUP	FORWARD VOLTAGE (V)	
	MIN.	MAX.
3A	1.90	2.05
3B	2.05	2.20
4A	2.20	2.35
4B	2.35	2.50
5A	2.50	2.65
5B	2.65	2.80
6A	2.80	3.00

Note:

Forward voltages are tested at a current pulse duration of 25 ms and a tolerance of ± 0.05 V.

In order to ensure availability, a single forward voltage group can not be ordered.

TYPICAL CHARACTERISTICS

$T_{amb} = 25\text{ }^{\circ}\text{C}$, unless otherwise specified

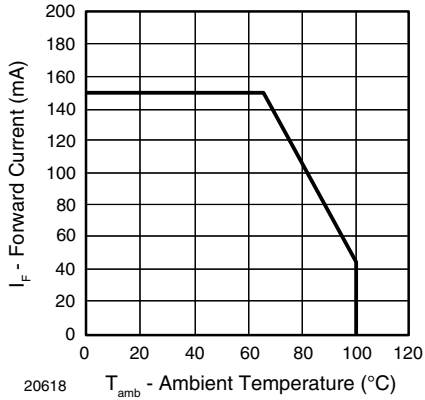

Figure 1. Forward Current vs. Ambient Temperature

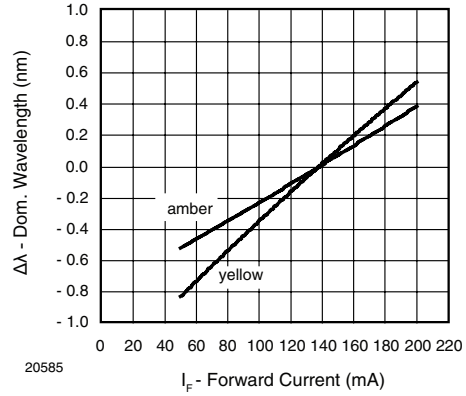

Figure 4. Dominant Wavelength vs. Forward Current

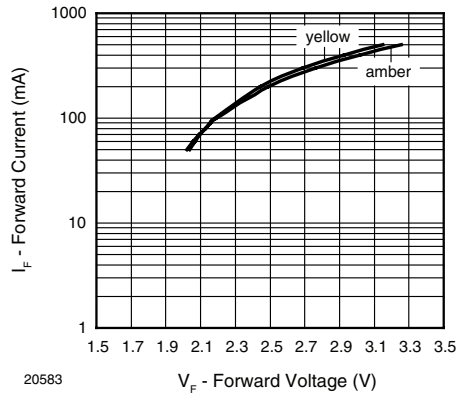

Figure 2. Forward Current vs. Forward Voltage

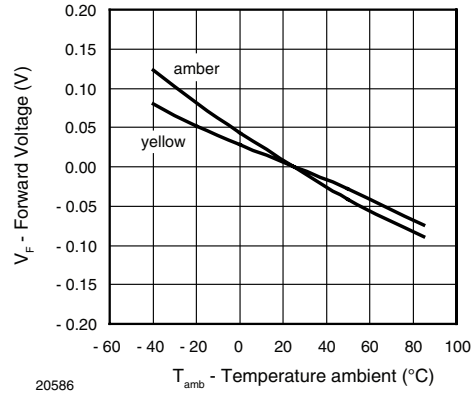

Figure 5. Forward Voltage vs. Ambient Temperature

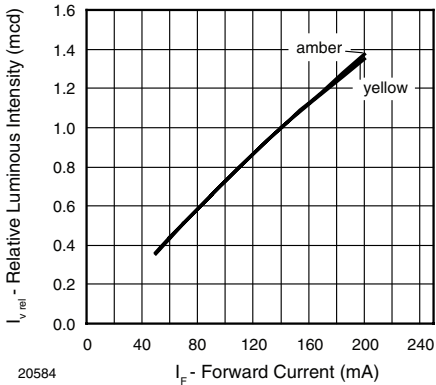

Figure 3. Relative Luminous Intensity vs. Forward Current

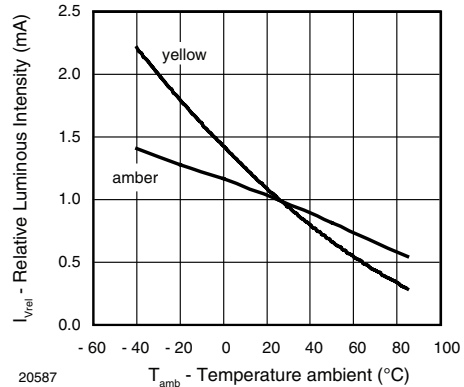

Figure 6. Relative Luminous Flux vs. Ambient Temperature

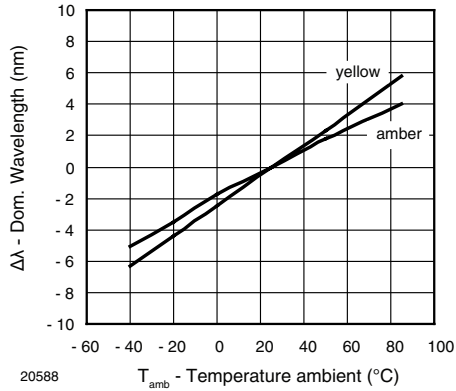
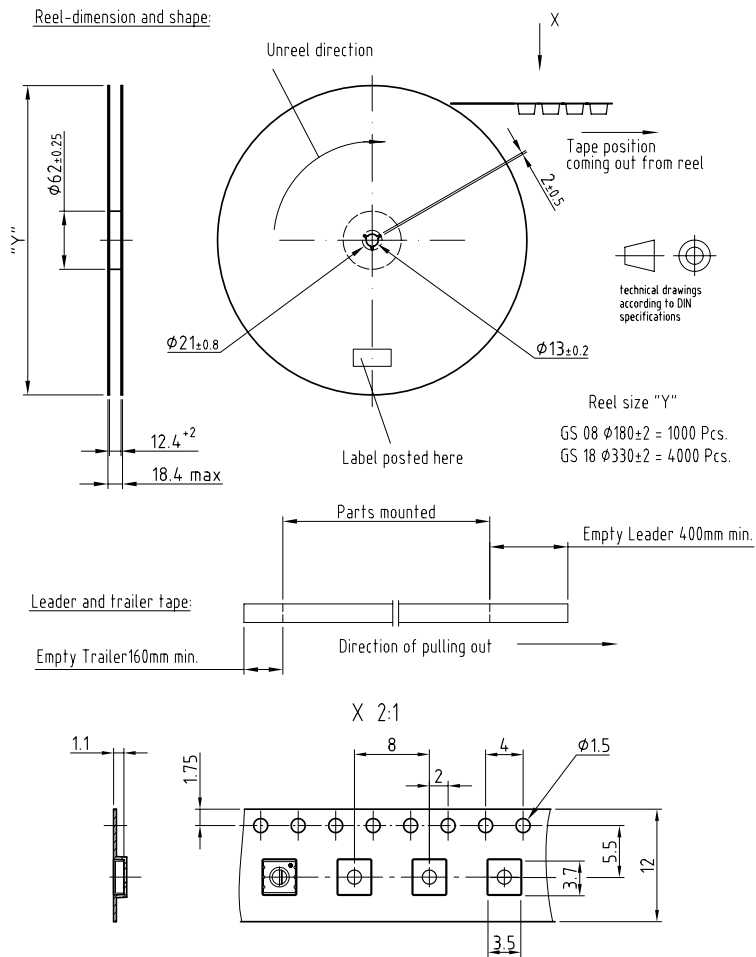

Figure 7. Dominant Wavelength vs. Ambient Temperature

TAPING DIMENSIONS in millimeters



Drawing-No.: 9.800-5098.01-4
Issue: 1; 17.09.07
20869

PACKAGE DIMENSIONS in millimeters

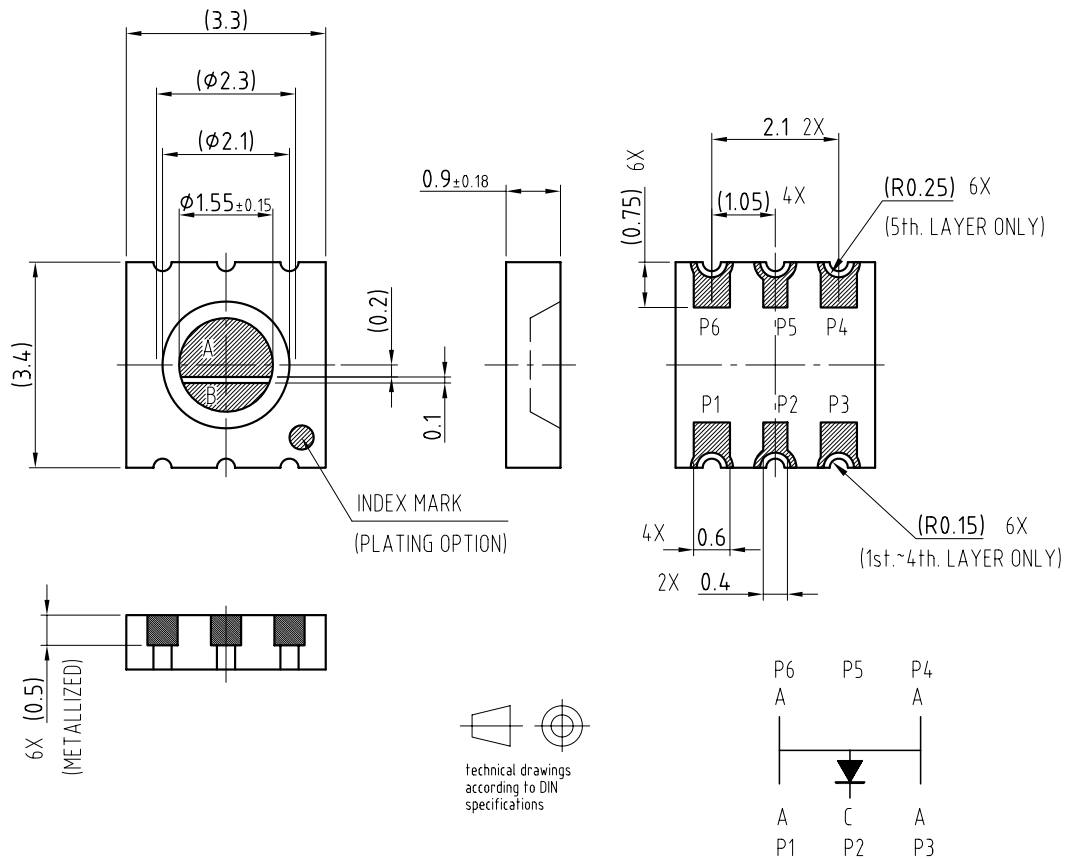

Drawing-No.: 6.581-5009.01-4
 Issue: 1; 21.08.07
 20833

Not indicated tolerances ±0.2

SOLDERING PADS DIMENSIONS in millimeters

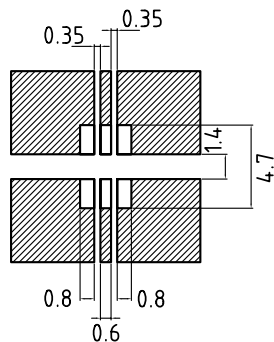

Drawing refers to following types: LA G67F Soldering pads

Drawing-No.: 6.581-5006.01-4
 Issue: 1; 07.02.07
 20598

SOLDERING PROFILE

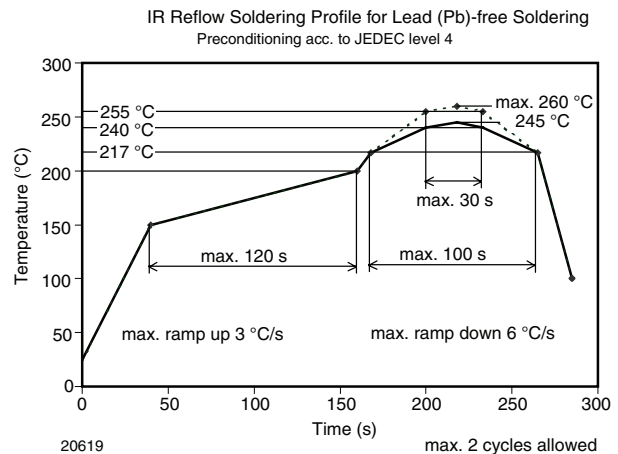
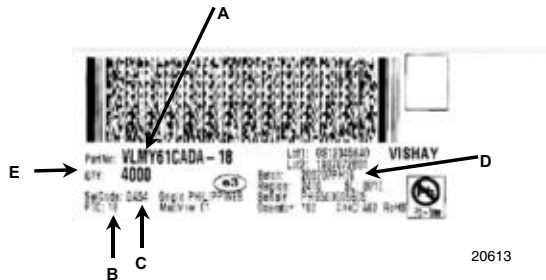

Figure 8. Vishay Lead (Pb)-free Reflow Soldering Profile (acc. to J-STD-020C)

**BAR CODE-PRODUCT-LABEL
EXAMPLE:**

- A) Type of component
- B) Manufacturing plant
- C) SEL - selection code (bin):
e.g.: DA = code for luminous intensity group
5 = code for color group
4 = code for forward voltage
- D) Batch:
200707 = year 2007, week 07
PH19 = plant code
- E) Total quantity

DRY PACKING

The reel is packed in an anti-humidity bag to protect the devices from absorbing moisture during transportation and storage.

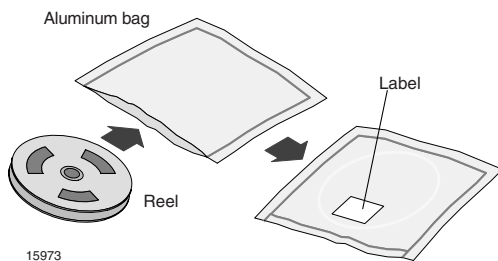
FINAL PACKING

The sealed reel is packed into a cardboard box. A secondary cardboard box is used for shipping purposes.

RECOMMENDED METHOD OF STORAGE

Dry box storage is recommended as soon as the aluminum bag has been opened to prevent moisture absorption. The following conditions should be observed, if dry boxes are not available:

- Storage temperature 10 °C to 30 °C
- Storage humidity ≤ 60 % RH max.

After more than 72 h under these conditions moisture content will be too high for reflow soldering.

In case of moisture absorption, the devices will recover to the former condition by drying under the following condition:

192 h at 40 °C + 5 °C/- 0 °C and < 5 % RH (dry air/nitrogen) or

96 h at 60 °C + 5 °C and < 5 % RH for all device containers or

24 h at 100 °C + 5 °C not suitable for reel or tubes.

An EIA JEDEC standard JESD22-A112 level 4 label is included on all aluminium dry bags.

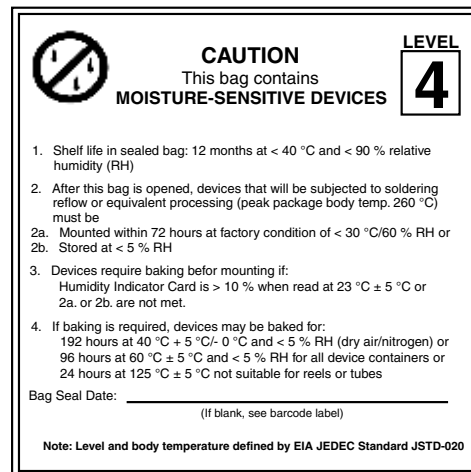

Example of JESD22-A112 level 4 label

ESD PRECAUTION

Proper storage and handling procedures should be followed to prevent ESD damage to the devices especially when they are removed from the antistatic shielding bag. Electro-static sensitive devices warning labels are on the packaging.

**VISHAY SEMICONDUCTORS STANDARD
BAR CODE LABELS**

The Vishay Semiconductors standard bar code labels are printed at final packing areas. The labels are on each packing unit and contain Vishay Semiconductors specific data.

OZONE DEPLETING SUBSTANCES POLICY STATEMENT

It is the policy of Vishay Semiconductor GmbH to

1. Meet all present and future national and international statutory requirements.
2. Regularly and continuously improve the performance of our products, processes, distribution and operating systems with respect to their impact on the health and safety of our employees and the public, as well as their impact on the environment.

It is particular concern to control or eliminate releases of those substances into the atmosphere which are known as ozone depleting substances (ODSs).

The Montreal Protocol (1987) and its London Amendments (1990) intend to severely restrict the use of ODSs and forbid their use within the next ten years. Various national and international initiatives are pressing for an earlier ban on these substances.

Vishay Semiconductor GmbH has been able to use its policy of continuous improvements to eliminate the use of ODSs listed in the following documents.

1. Annex A, B and list of transitional substances of the Montreal Protocol and the London Amendments respectively
2. Class I and II ozone depleting substances in the Clean Air Act Amendments of 1990 by the Environmental Protection Agency (EPA) in the USA
3. Council Decision 88/540/EEC and 91/690/EEC Annex A, B and C (transitional substances) respectively.

Vishay Semiconductor GmbH can certify that our semiconductors are not manufactured with ozone depleting substances and do not contain such substances.

The IEC/EN standards require that the desired classification Accessible Emission Limit shall not be exceeded in "Normal" and "Single Fault Conditions". This product is in Compliance with the requirement in CEN/IEC/EN60825-1 to ensure that required classifications are not exceeded in single fault conditions.

We reserve the right to make changes to improve technical design
and may do so without further notice.

Parameters can vary in different applications. All operating parameters must be validated for each customer application by the customer. Should the buyer use Vishay Semiconductors products for any unintended or unauthorized application, the buyer shall indemnify Vishay Semiconductors against all claims, costs, damages, and expenses, arising out of, directly or indirectly, any claim of personal damage, injury or death associated with such unintended or unauthorized use.

Vishay Semiconductor GmbH, P.O.B. 3535, D-74025 Heilbronn, Germany



Notice

Specifications of the products displayed herein are subject to change without notice. Vishay Intertechnology, Inc., or anyone on its behalf, assumes no responsibility or liability for any errors or inaccuracies.

Information contained herein is intended to provide a product description only. No license, express or implied, by estoppel or otherwise, to any intellectual property rights is granted by this document. Except as provided in Vishay's terms and conditions of sale for such products, Vishay assumes no liability whatsoever, and disclaims any express or implied warranty, relating to sale and/or use of Vishay products including liability or warranties relating to fitness for a particular purpose, merchantability, or infringement of any patent, copyright, or other intellectual property right.

The products shown herein are not designed for use in medical, life-saving, or life-sustaining applications. Customers using or selling these products for use in such applications do so at their own risk and agree to fully indemnify Vishay for any damages resulting from such improper use or sale.