

LQM18DN150M70L

“#” indicates a package specification code.

Bias Current Characteristics Improved



< List of part numbers with package codes >

LQM18DN150M70B LQM18DN150M70L

Appearance & Shape

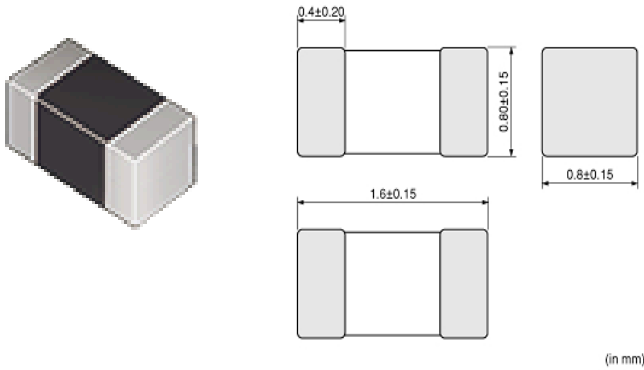

References

Packaging	Specifications	Standard Packing Quantity
B	Bulk(Bag)	1000
L	180Embossed Tape	4000

Mass (typ.)	
1 piece	0.005g

Attention

- 1.This datasheet is downloaded from the website of Murata Manufacturing Co., Ltd. Therefore, it's specifications are subject to change or our products in it may be discontinued without advance notice. Please check with our sales representatives or product engineers before ordering.
- 2.This datasheet has only typical specifications because there is no space for detailed specifications. Therefore, please review our product specifications or consult the approval sheet for product specifications before ordering.

LQM18DN150M70L

“#” indicates a package specification code.



Specifications

L size	1.6±0.15mm
W size	0.8±0.15mm
T size	0.8±0.15mm
Size code inch (mm)	0603 (1608)
Inductance	15μH±20%
Inductance Test Frequency	1MHz
Rated current (Isat) (Based on Inductance change)	80mA
Rated current (Itemp) (Based on Temperature rise)	220mA
Max. of DC resistance	2.54Ω
Class of magnetic shield	Ferrite Core
Self resonance frequency (min.)	24MHz
DC Resistance Intermediate Values	1.95Ω±0.59Ω
Operating Temperature Range	-55°C to 125°C
Series	LQM18DN_70

Attention

1.This datasheet is downloaded from the website of Murata Manufacturing Co., Ltd. Therefore, it's specifications are subject to change or our products in it may be discontinued without advance notice. Please check with our sales representatives or product engineers before ordering.

2.This datasheet has only typical specifications because there is no space for detailed specifications.

Therefore, please review our product specifications or consult the approval sheet for product specifications before ordering.