

## RTKA223011DR0030BU

Demonstration Board

The RTKA223011DR0030BU demonstration board is a high voltage buck converter that demonstrates a low-cost high performance non-isolated AC/DC conversion from a universal input of  $85V_{AC} \sim 265V_{AC}$  to a 24V output with an output current up to 200mA.

The board has built-in overcurrent, short-circuit, input brownout and over-temperature protections.

RTKA223011DR0030BU comes in a RAA223011 in 8 Ld SOIC package.

### Key Features

- Universal input
- Standby power less than 13mW
- No audible noise
- Low cost external components

### Specifications

This board is optimized for the following operating conditions:

- Input voltage:  $85V_{AC} \sim 265V_{AC}$
- Output voltage:  $24V_{DC}$
- Output current: 200mA max (at  $230V_{AC}$  or higher)
- Efficiency: >75% at 100% load; 82% at 50% load
- No-load power: 11.9mW at  $120V_{AC}$ ; 12.3mW at  $230V_{AC}$
- Load regulation: -2.2%, load range 10% to 100%
- Operating temperature:  $-45^{\circ}C \sim 70^{\circ}C$
- Board dimension: 29mm x 52mm

### Ordering Information

Part Number	Description
RTKA223011DR0030BU	RAA223011 SO8 demonstration board

### Related Literature

For a full list of related documents, visit our website:

- [RAA223011](#) device page

# 1. Circuit Description

The RTKA223011DR0030BU is a buck regulator implemented with a high-side float-switching topology, with switching frequency up to 30kHz. Its input has D1, D5, D6, and D7 operating as a full-bridge rectifier. FR is a 1W fusible resistor providing input overcurrent protection and inrush current limiting.

C1, L1, and C2 consists of the input filter that provides the energy buffer after rectification and reduces conducted EMI noises to the input. L2, D2, and C<sub>OUT</sub> are the buck converter components. RFB1, RFB2, CFB2, and CFB1 provide the output feedback signal to the IC. D4 and R2 provide V<sub>CC</sub> biasing current after startup, to increase the efficiency. They can be optional for low-cost, low-power applications. C<sub>VCC</sub> is the IC supply capacitor.

## 1.1 Recommended Equipment

- AC power supply capable of generating AC voltage from 85V<sub>AC</sub> to 265V<sub>AC</sub> at 60Hz/50Hz, with at least 100mA output current capability.
- Load resistor box with adjustable value of 120Ω and up, or an electronics load that can emulate a resistor load or current load up to 200mA.
- Multi-meters to measure the output voltage and current.
- Power meter to measure the AC input power.

## 1.2 Quick Start Guide

1. Program the AC power supply with a voltage between 85V<sub>AC</sub> and 265V<sub>AC</sub> at the corresponding frequency of 60Hz or 50Hz.
2. While the AC power supply is off, connect the output cables of the AC power supply to the L and N terminal of the RTKA223011DR0030BU. An optional power meter can be added in between AC power supply output and the input of the board.
3. Connect the load to the output terminals VOUT and GND.
4. Connect a voltage meter to VOUT and GND and connect a current meter between board outputs and the load.
5. Turn on AC power supply.

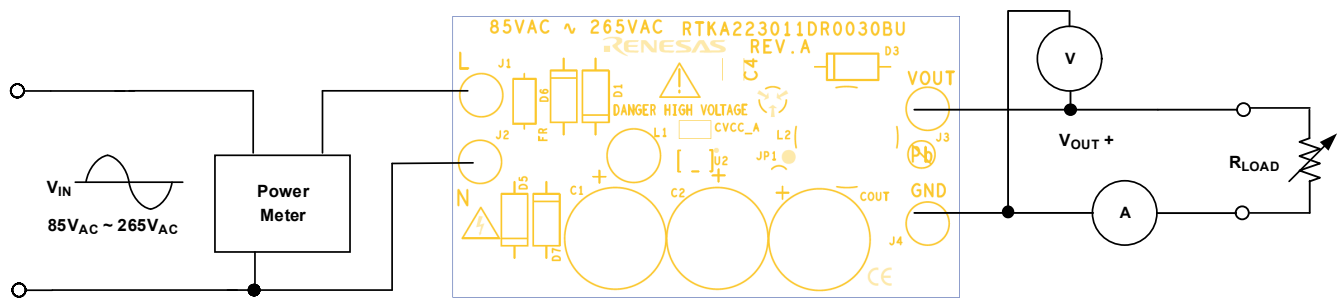

Figure 1. RTKA223011DR0030BU Connection Diagram

## 2. Board Design

### 2.1 PCB Layout Guidelines

For detailed PCB guidelines, see the RAA223011 datasheet.

### 2.2 RTKA223011DR0030BU Evaluation Board

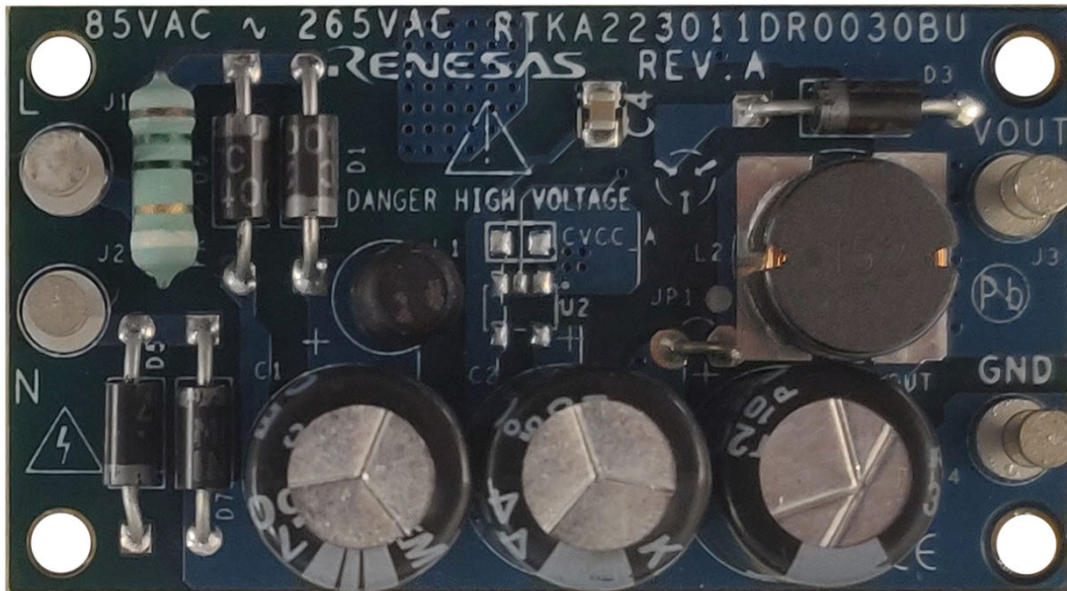

Figure 2. RTKA223011DR0030BU Evaluation Board (Top)

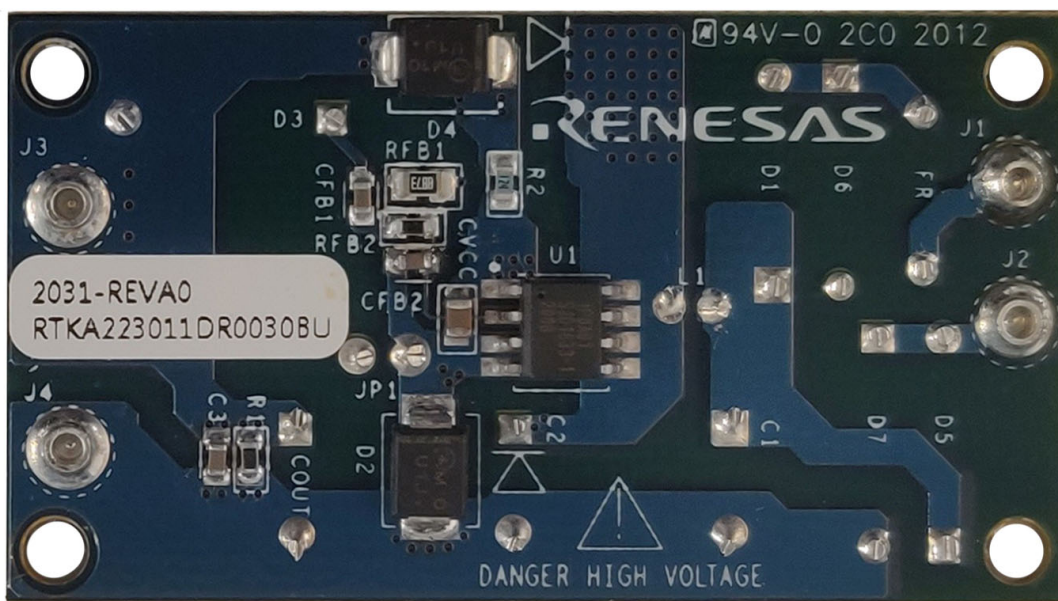

Figure 3. RTKA223011DR0030BU Evaluation Board (Bottom)

### 2.3 RTKA223011DR0030BU Circuit Schematic

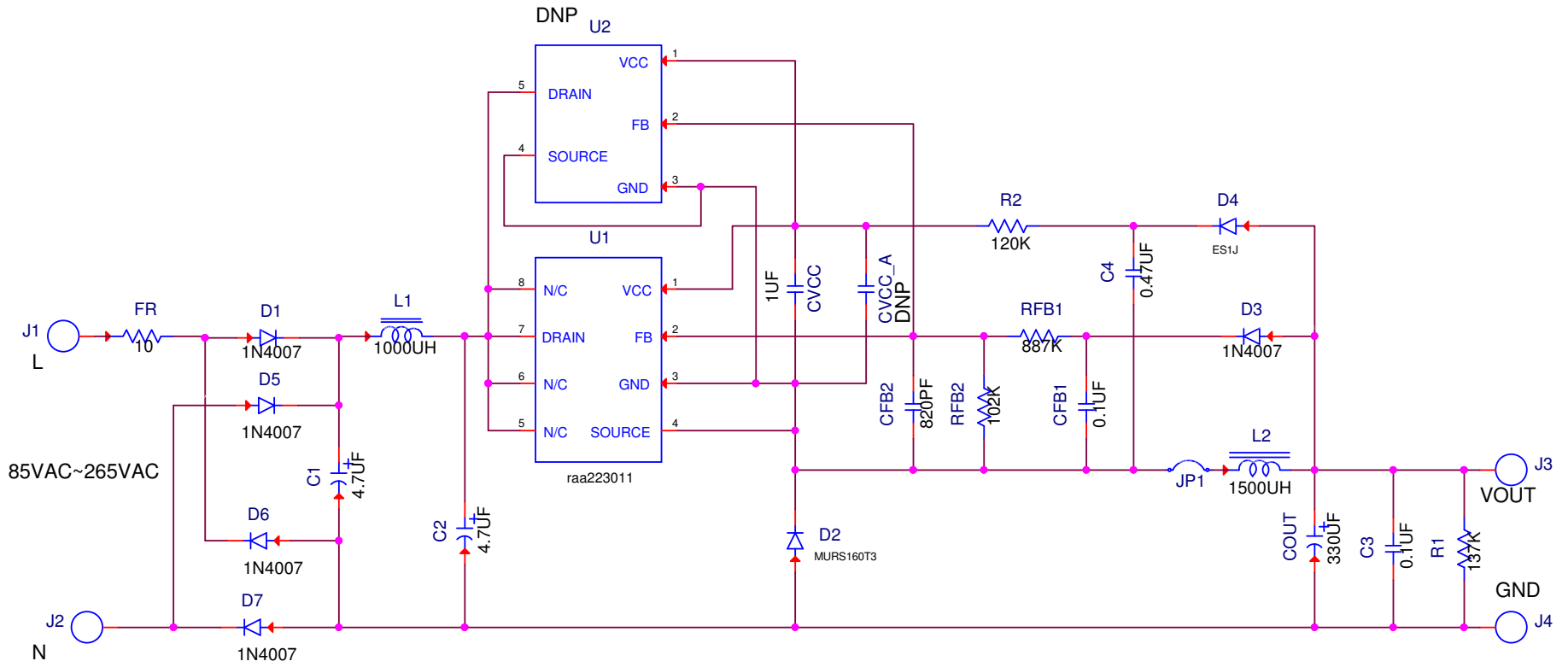

Figure 4. RTKA223011DR0030BU Schematic

## 2.4 Bill of Materials

Qty	Ref Des	Description	Manufacturer	Part Number
5	D1, D3, D5-D7	Generic Diode, 1kV, 1A, DO41	Various	1N4007
1	COUT	CAP ALUM 330 $\mu$ F 20% 35V RADIAL	Rubycon	35ZLH330MEFCT810X12.5
1	FR	Miniature Metal Film Resistor, 10 $\Omega$ , 1W, Wirewound	Yageo	FKN1WSJR-52-10R
2	C1, C2	CAP ALUM 4.7 $\mu$ F 20% 400V RADIAL	Kemet	ESG475M400AH2AA
1	CVCC	Multilayer Cap, 1 $\mu$ F, 50V, 10%, 0603	Murata	Generic
0	CVCCA	Do Not Populate		
1	CFB2	Multilayer Cap, 820PF, 50V, 10%, 0603	Generic	
2	C3, CFB1	Multilayer Cap, 0.1 $\mu$ F, 50V, 10%, 0603	Generic	
1	C4	Multilayer Cap, 0.47 $\mu$ F, 50V, 10%, 0603	Generic	
1	RFB2	Thick Film Chip Resistor, 102k, 1/16W, 1%, 0603	Generic	
1	R1	Thick Film Chip Resistor, 137k, 1/16W, 1%, 0603	Generic	
1	RFB1	Thick Film Chip Resistor, 887k, 1/10W, 1%, 0603	Generic	
1	D4	1A 600V Fast Rectifier Diode, DO214	Fairchild	ES1J
1	D2	Ultrafast Power Rectifier, 600V, 2A, SMB	On Semiconductor	MURS160T3
0	U2	Do Not Populate		
1	U1	700V, AC/DC Buck Regulator, SO8	Renesas	RAA2230114GSP#JA0
1	R2	Thick Film Chip Resistor, 120k, 1/16W, 1%, 0603	Generic	Generic
1	L1	RLB Series Radial Lead Inductor, 1mH, 10%, 100MA, Type2	Bourns	RLB0608-102KL
1	L2	Power Inductor, 1.5mH, 10%, 0.45A, SMD	Bourns	SDR1006-152KL

## 2.5 Board Layout

To download our design files, visit our [website](#).

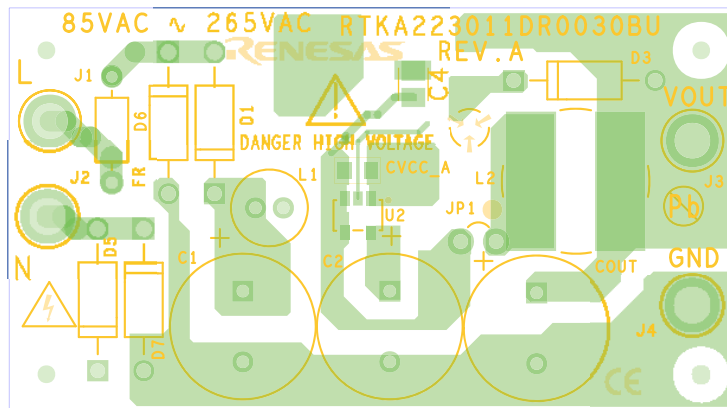

Figure 5. Top Layer

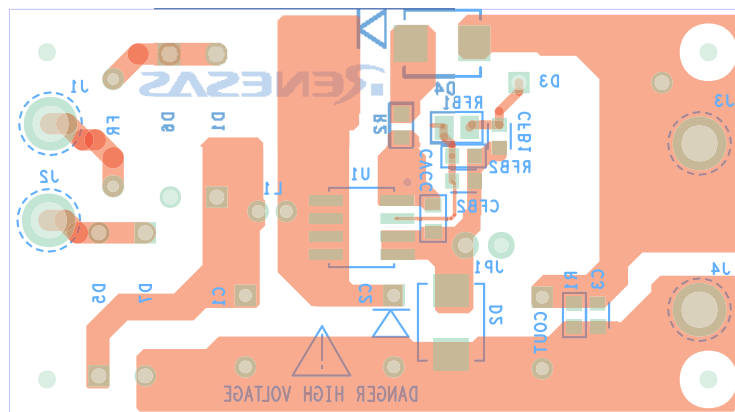

Figure 6. Bottom Layer

### 3. Typical Performance Curves

$V_{in} = 85V_{AC} \sim 265V_{AC}$ ,  $V_{OUT} = 24V$ ,  $I_{OUT} = 200mA$  (maximum),  $T_A = +25^{\circ}C$

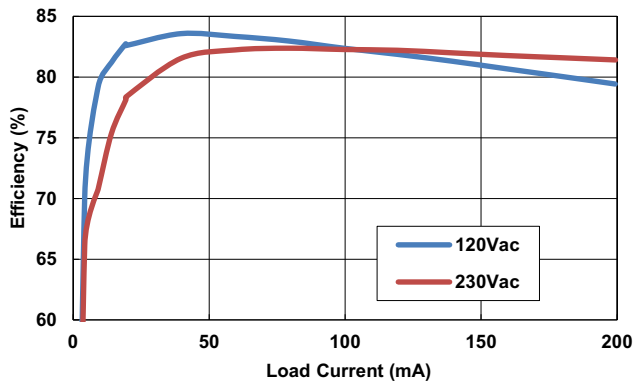

Figure 7. Efficiency Overload Current

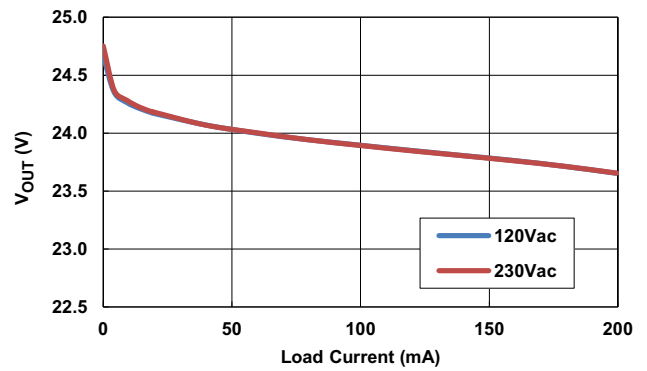

Figure 8. Load Regulation

Table 1. Typical No-Load Power Consumption

Power Supply	Standby Power	Energy Star
120V <sub>AC</sub> /60Hz	11.9mW	300mW
230V <sub>AC</sub> /50Hz	12.3mW	300mW

## 4. Revision History

Revision	Date	Description
1.0	Feb 11, 2021	Initial release



## IMPORTANT NOTICE AND DISCLAIMER

RENESAS ELECTRONICS CORPORATION AND ITS SUBSIDIARIES (“RENESAS”) PROVIDES TECHNICAL SPECIFICATIONS AND RELIABILITY DATA (INCLUDING DATASHEETS), DESIGN RESOURCES (INCLUDING REFERENCE DESIGNS), APPLICATION OR OTHER DESIGN ADVICE, WEB TOOLS, SAFETY INFORMATION, AND OTHER RESOURCES “AS IS” AND WITH ALL FAULTS, AND DISCLAIMS ALL WARRANTIES, EXPRESS OR IMPLIED, INCLUDING, WITHOUT LIMITATION, ANY IMPLIED WARRANTIES OF MERCHANTABILITY, FITNESS FOR A PARTICULAR PURPOSE, OR NON-INFRINGEMENT OF THIRD PARTY INTELLECTUAL PROPERTY RIGHTS.

These resources are intended for developers skilled in the art designing with Renesas products. You are solely responsible for (1) selecting the appropriate products for your application, (2) designing, validating, and testing your application, and (3) ensuring your application meets applicable standards, and any other safety, security, or other requirements. These resources are subject to change without notice. Renesas grants you permission to use these resources only for development of an application that uses Renesas products. Other reproduction or use of these resources is strictly prohibited. No license is granted to any other Renesas intellectual property or to any third party intellectual property. Renesas disclaims responsibility for, and you will fully indemnify Renesas and its representatives against, any claims, damages, costs, losses, or liabilities arising out of your use of these resources. Renesas' products are provided only subject to Renesas' Terms and Conditions of Sale or other applicable terms agreed to in writing. No use of any Renesas resources expands or otherwise alters any applicable warranties or warranty disclaimers for these products.

(Rev.1.0 Mar 2020)

### Corporate Headquarters

TOYOSU FORESIA, 3-2-24 Toyosu,  
Koto-ku, Tokyo 135-0061, Japan  
[www.renesas.com](http://www.renesas.com)

### Contact Information

For further information on a product, technology, the most up-to-date version of a document, or your nearest sales office, please visit:  
[www.renesas.com/contact/](http://www.renesas.com/contact/)

### Trademarks

Renesas and the Renesas logo are trademarks of Renesas Electronics Corporation. All trademarks and registered trademarks are the property of their respective owners.