

## SHT4x

### 4<sup>th</sup> Generation, High-Accuracy, Ultra-Low-Power, 16-bit Relative Humidity and Temperature Sensor

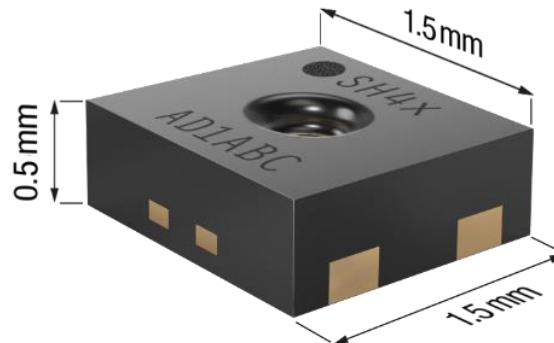

#### Features

- Relative humidity accuracy: up to  $\pm 1.5$  %RH
- Temperature accuracy: up to  $\pm 0.1$  °C
- Supply voltage: 1.08 V ... 3.6 V
- Average current: 0.4  $\mu$ A (at meas. rate 1 Hz)
- Idle current: 80 nA
- I2C fast mode plus, CRC checksum
- Operating range: 0...100 %RH, -40...125 °C
- Fully functional in condensing environment
- Variable power heater
- NIST traceability
- JEDEC JESD47 qualification
- Mature technology from global market leader

#### General Description

SHT4x is a digital sensor platform for measuring relative humidity and temperature at different accuracy classes. The I2C interface provides several preconfigured I2C addresses and maintains an ultra-low power budget. The power-trimmed internal heater can be used at three heating levels thus enabling sensor operation in demanding environments. The four-pin dual-flat-no-leads package is suitable for surface mount technology (SMT) processing.

#### Device Overview

Products	Details
SHT40-AD1B	base RH&T accur., 0x44 I2C addr.
SHT40-BD1B	base RH&T accur., 0x45 I2C addr.
SHT41-AD1B	Intermed. RH&T accur., 0x44 I2C addr.
SHT45-AD1B	$\pm 1.5$ %RH, $\pm 0.1$ °C accur., 0x44 I2C addr.

Full product list on page 15

#### Functional Block Diagram

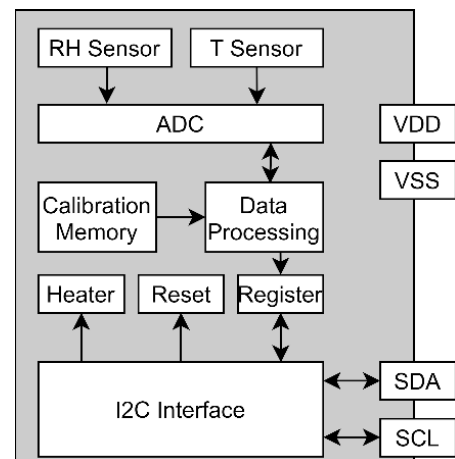

# Contents

Features .....	1
General Description .....	1
Device Overview .....	1
Functional Block Diagram .....	1
1 Quick Start – Hello World .....	3
2 Humidity and Temperature Sensor Specifications .....	4
2.1 Relative Humidity .....	4
2.2 Temperature .....	5
2.3 Recommended Operating Conditions .....	6
3 Electrical Specifications .....	6
3.1 Electrical Characteristics .....	7
3.2 Timings .....	7
3.3 Absolute Maximum Ratings .....	8
4 Sensor Operation .....	8
4.1 I2C communication .....	8
4.2 Data type & length .....	9
4.3 Checksum Calculation .....	9
4.4 Command Overview .....	10
4.5 Conversion of Signal Output .....	10
4.6 Serial number .....	11
4.7 Reset & Abort .....	11
4.8 Heater Operation .....	11
5 Physical Specification .....	12
5.1 Package Description .....	12
5.2 Package Outline .....	12
5.3 Land Pattern .....	12
5.4 Pin Assignment & Laser Marking .....	13
5.5 Thermal Information .....	14
6 Quality and Material Contents .....	14
7 Tape and Reel Packaging .....	14
8 Product Name Nomenclature .....	15
9 Ordering Information .....	15
10 Bibliography .....	15
11 Revision History .....	16

## 1 Quick Start – Hello World

A typical application circuit for SHT4x is shown on the left-hand side of **Figure 1**. After reaching the minimal supply voltage and allowing for the maximal power-up time of 1 ms the sensor is ready for I2C communication. The quickest way to measure humidity and temperature is pseudo-coded on the right-hand side of **Figure 1**. Together with the conversion formulae given in equations ( 1 ), ( 2 ), and ( 3 ), the digital signals can be translated into relative humidity and temperature readings.

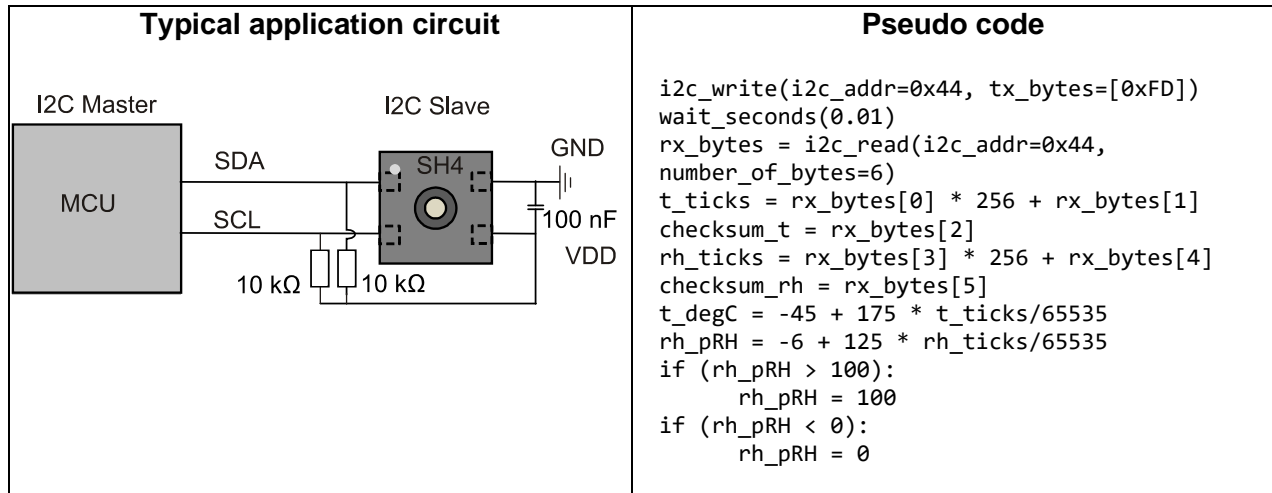

**Figure 1:** Typical application circuit (left) and pseudo code (right) for easy starting. For details on the signal cropping in the last four lines see **section 4.5**.

Find code resources and embedded drivers on: <https://github.com/Sensirion/embedded-sht/releases>



CAD files can be downloaded from SnapEDA: <https://www.snapeda.com/parts/SHT40-AD1B-R3/Sensirion/view-part/>



## 2 Humidity and Temperature Sensor Specifications

Every SHT4x is individually tested and calibrated and is identifiable by its unique serial number (see section 4.6 for details on the serial number). For the calibration, Sensirion uses transfer standards, which are subject to a scheduled calibration procedure. The calibration of the reference, used for the calibration of the transfer standards, is NIST traceable through an ISO/IEC 17025 accredited laboratory.

### 2.1 Relative Humidity

Parameter	Conditions	Value	Units
SHT40 RH accuracy <sup>1</sup>	typ.	±1.8	%RH
	max.	see <b>Figure 2</b>	-
SHT41 RH accuracy <sup>1</sup>	typ.	±1.8	%RH
	max.	See <b>Figure 3</b>	-
SHT45 RH accuracy <sup>1</sup>	typ.	±1.5	%RH
	max.	tbd	-
Repeatability <sup>2, 3</sup>	high	0.08	%RH
	medium	0.15	%RH
	low	0.25	%RH
Resolution <sup>4</sup>	-	0.01	%RH
Hysteresis	-	±1	%RH
Specified range <sup>5</sup>	extended <sup>6</sup>	0 to 100	%RH
Response time <sup>7</sup>	$t_{63\%}$	6	s
Long-term drift <sup>8</sup>	typ.	<0.25	%RH/y

**Table 1:** General relative humidity sensor specifications.

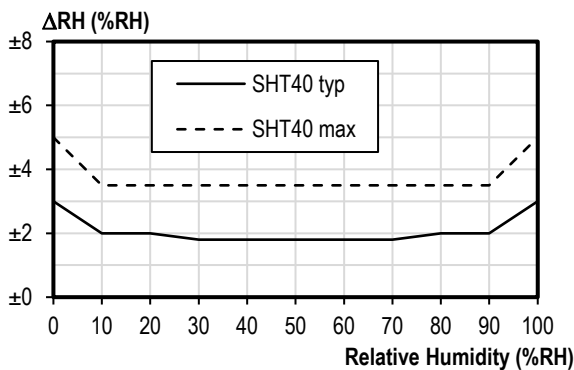

**Figure 2:** SHT40 typical and maximal relative humidity accuracy at 25 °C.

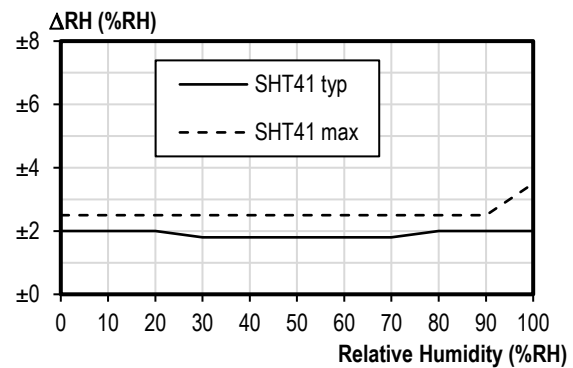

**Figure 3:** SHT41 typical and maximal relative humidity accuracy at 25 °C.

<sup>1</sup> For definition of typ. and max. accuracy, please refer to the document "Sensirion Humidity Sensor Specification Statement".

<sup>2</sup> The stated repeatability is 3 times the standard deviation (3σ) of multiple consecutive measurement values at constant conditions and is a measure for the noise on the physical sensor output. Different repeatability commands are listed in Table 7.

<sup>3</sup> Valid for 25°C and 50%RH.

<sup>4</sup> Resolution of A/D converter.

<sup>5</sup> Specified range refers to the range for which the humidity or temperature sensor specification is guaranteed.

<sup>6</sup> For details about recommended humidity and temperature operating range, please refer to section 2.3.

<sup>7</sup> Time for achieving 63% of a humidity step function, measured at 25°C and 1 m/s airflow. Humidity response time in the application depends on the design-in of the sensor.

<sup>8</sup> Typical value for operation in normal RH/T operating range. Max. value is < 0.5 %RH/y. Value may be higher in environments with vaporized solvents, out-gassing tapes, adhesives, packaging materials, etc. For more details please refer to Handling Instructions.

**Relative Humidity Accuracy at the Extended Temperature Range**

The typical RH accuracy tolerances in the range of T=0°C ... 80 °C are given in **Figure 6** and **Figure 7**.

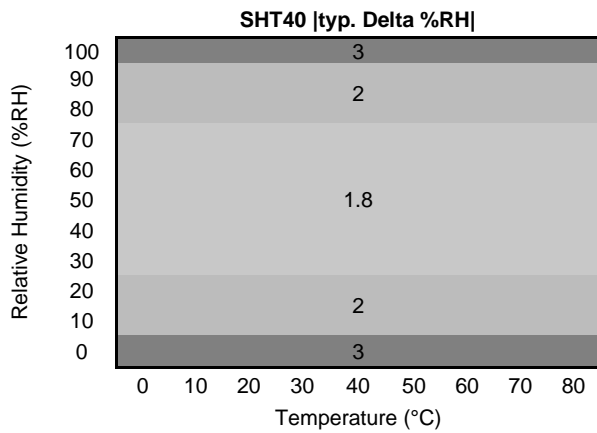

**Figure 4:** Typical RH accuracy tolerance over humidity and temperature for SHT40.

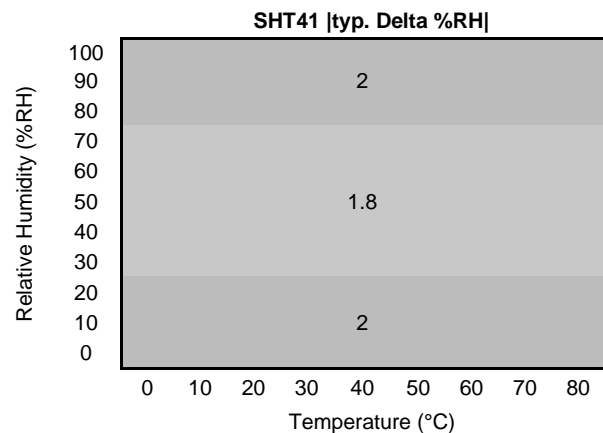

**Figure 5:** Typical RH accuracy tolerance over humidity and temperature for SHT41.

**2.2 Temperature**

Parameter	Conditions	Value	Units
SHT40 T Accuracy <sup>1</sup>	typ.	±0.2	°C
	max.	see <b>Figure 6</b>	-
SHT41 T Accuracy <sup>1</sup>	typ.	±0.2	°C
	max.	See <b>Figure 7</b>	-
SHT45 T Accuracy <sup>1</sup>	typ.	±0.1	°C
	max.	tbd	-
Repeatability <sup>2</sup>	high	0.04	°C
	medium	0.07	°C
	low	0.1	°C
Resolution <sup>4</sup>	-	0.01	°C
Specified range <sup>5</sup>	-	-40 to +125	°C
Response time <sup>9</sup>	t <sub>63%</sub>	2	s
Long-term drift <sup>10</sup>	typ.	<0.03	°C/y

**Table 2:** General temperature sensor specifications.

<sup>9</sup> Temperature response time depends on heat conductivity of sensor substrate and design-in of sensor in application.

<sup>10</sup> Max. value is < 0.04°C/y.

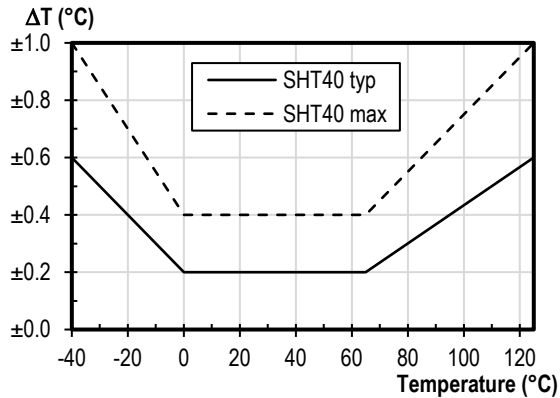

**Figure 6:** SHT40 typical and maximal temperature accuracy.

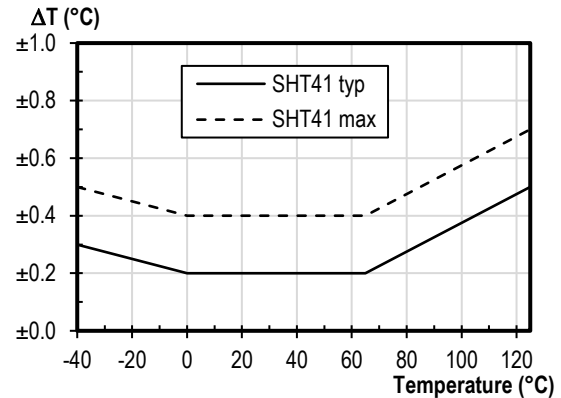

**Figure 7:** SHT41 typical and maximal temperature accuracy.

### 2.3 Recommended Operating Conditions

The sensor shows best performance when operated within the recommended normal temperature and humidity range of 5 °C ... 60 °C and 20 %RH ... 80 %RH, respectively. Long term exposure to conditions outside recommended normal range, especially at high relative humidity, may temporarily offset the RH signal (e.g. +3 %RH after 60 h at > 80 %RH). After returning into the recommended normal temperature and humidity range the sensor will recover to within specifications by itself. Prolonged exposure to extreme conditions may accelerate ageing.

To ensure stable operation of the humidity sensor, the conditions described in the document (Sensirion, 2020) regarding exposure to volatile organic compounds must be met. Please note as well that this does apply not only to transportation and manufacturing, but also to operation of the SHT4x.

## 3 Electrical Specifications

Valid for all electrical specifications: Typical values correspond to  $V_{DD} = 3.3 \text{ V}$  and  $T = 25 \text{ °C}$ . Min. and max. values are valid in the full temperature range  $-40 \text{ °C} \dots 125 \text{ °C}$  and at declared  $V_{DD}$  levels.

**3.1 Electrical Characteristics**

Parameter	Sym bol	Conditions	Min	Typ	Max	Unit	Comments
Supply voltage	V <sub>DD</sub>		1.08	3.3	3.6	V	-
Power-up/down level	V <sub>POR</sub>	Static power supply	0.6	-	1.08	V	-
Supply current (no heater)	I <sub>DD</sub>	Idle state	-	0.1	1.0	μA	At 25°C At 125°C
			-	-	3.4		
		Measurement	-	350	500	μA	Current while sensor is measuring
Power consumpt. at VDD=1.2V (no heater)	-	Aver., high repeatability	-	2.9	-	μW	Aver. power consumption (continuous operation with one meas. per second)
		Aver., med. repeatability	-	1.6	-		
		Aver., low repeatability	-	0.5	-		
			-	-	-		
Low level input voltage	V <sub>IL</sub>	-	0	-	0.3* V <sub>DD</sub>	V	-
High level input voltage	V <sub>IH</sub>	-	0.7* V <sub>DD</sub>	-	V <sub>DD</sub>	V	-
Pull up resistors	R <sub>p</sub>	V <sub>DD</sub> < 1.62 V	820	-	-	Ω	-
		V <sub>DD</sub> ≥ 1.62 V	390	-	-	Ω	-
Low level output voltage	V <sub>OL</sub>	V <sub>DD</sub> < 1.62V, R <sub>pullup</sub> > 820 Ω	-	-	0.2* V <sub>DD</sub>	V	-
		V <sub>DD</sub> = 1.62V ... 2.0V, R <sub>pullup</sub> > 390 Ω	-	-	0.2* V <sub>DD</sub>	V	-
		V <sub>DD</sub> > 2.0V, R <sub>pullup</sub> > 390 Ω	-	-	0.4	V	-
Cap bus load	C <sub>b</sub>	R <sub>p</sub> ≤ 820 Ω: fast mode	-	-	400	pF	Capac. bus load can be determined from C <sub>b</sub> < t <sub>rise</sub> / (0.8473 * R <sub>p</sub> ). Rise times are t <sub>rise</sub> = 300 ns for fast mode and t <sub>rise</sub> = 120 ns for fast mode plus
		R <sub>p</sub> = 390 Ω, V <sub>DD</sub> > 1.62 V: fast mode plus	-	-	340	pF	

**Table 3:** Electrical specifications.

**3.2 Timings**

Max. values are measured at -40°C and 1.08 V supply voltage (based on characterization).

Parameter	Symbol	Conditions	Min.	Typ.	Max.	Units	Comments
Power-up time	$t_{PU}$	After hard reset, $V_{DD} \geq V_{POR}$	-	0.3	1	ms	Time between $V_{DD}$ reaching $V_{POR}$ and sensor entering idle state
Soft reset time	$t_{SR}$	After soft reset	-	-	1	ms	Time between ACK of soft reset command and sensor entering idle state. Also valid for I2C general call reset.
Measurement duration	$t_{MEAS,l}$	Low repeatability	-	1.3	1.7	ms	The three repeatability modes differ with respect to measurement duration, noise level and energy consumption
	$t_{MEAS,m}$	Med. repeatability	-	3.7	4.5	ms	
	$t_{MEAS,h}$	High repeatability	-	6.9	8.2	ms	
Heater-on duration	$t_{Heater}$	Long pulse	0.9	1	1.1	s	After that time the heater is automatically switched off
		Short pulse	0.09	0.1	0.11	s	After that time the heater is automatically switched off

**Table 4** System timing specifications.

### 3.3 Absolute Maximum Ratings

Stress levels beyond those listed in Table 5 may cause permanent damage or affect the reliability of the device. These are stress ratings only and functional operation of the device at these conditions is not guaranteed. Ratings are only tested each at a time.

Parameter	Rating
Max. voltage on any pin	$V_{SS} - 0.3\text{ V} \dots V_{DD} + 0.3\text{ V}$
Operating temperature range	-40 °C ... 125 °C
Storage temperature range <sup>11</sup>	-40 °C ... 150 °C
ESD HBM	2 kV
ESD CDM	500 V
Latch up, JEDEC Class II, 125°C	+/-100 mA

**Table 5:** Absolute maximum ratings.

## 4 Sensor Operation

### 4.1 I2C communication

I2C communication is based on NXP’s I2C-bus specification and user manual UM10204, Rev.6, 4 April 2014. Supported I2C modes are standard, fast mode, and fast mode plus. Data is transferred in multiples of 16-bit words and 8-bit checksum (cyclic redundancy check = CRC). All transfers must begin with a start condition (S) and terminate with a stop condition (P). To finish a read transfer, send not acknowledge (NACK) and stop condition (P). Addressing a specific slave device is done by sending its 7-bit I2C address followed by an eighth bit, denoting the communication direction: “zero” indicates transmission to the slave, i.e. “write”, a “one” indicates a “read” request. Schematics of the I2C transfer types are sketched in **Figure 8**. The sensor does not support clock-stretching. In case the sensor receives a read header and is still busy with e.g. measurement or

<sup>11</sup> The recommended storage temperature range is 10-50°C. Please consult the document “SHTxx Handling Instructions” for more information.



heating, it will return a NACK. Measurement data can only be received once and will be deleted from the sensor's register after the first acknowledged I2C read header.

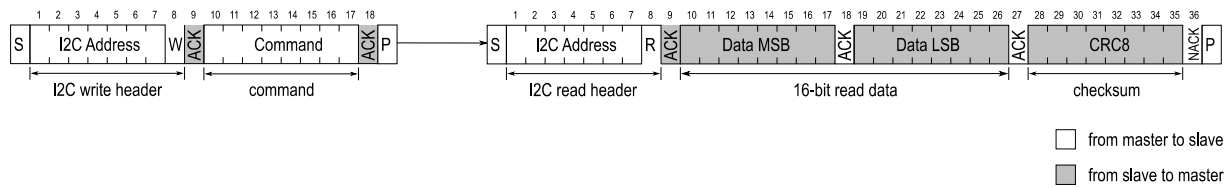

**Figure 8:** I2C transfer types: First a write header is sent to the I2C slave, followed by a command, for example “measure RH&T with highest precision”. After the measurement is finished the read request directed to this I2C slave will be acknowledged and transmission of data will be started by the slave.

**4.2 Data type & length**

I2C bus operates with 8-bit data packages. Information from the sensor to the master has a checksum after every second 8-bit data package.

Humidity and temperature data will always be transmitted in the following way: The first value is the temperature signal (2 \* 8-bit data + 8-bit CRC), the second is the humidity signal (2 \* 8-bit data + 8-bit CRC).

**4.3 Checksum Calculation**

For read transfers each 16-bit data is followed by a checksum with the following properties

Property	Value
Name	CRC-8
Message Length	16-bit
Polynomial	0x31 ( $x^8 + x^5 + x^4 + 1$ )
Initialization	0xFF
Reflect Input/Output	false/false
Final XOR	0x00
Examples	CRC(0xBEEF) = 0x92

**Table 6** Data checksum properties.

The master may abort a read transfer after the 16-bit data, if it does not require a checksum.

**4.4 Command Overview**

Command (hex)	Response length incl. CRC (bytes)	Description [return values]
0xFD	6	measure T & RH with high precision (high repeatability) [2 * 8-bit T-data; 8-bit CRC; 2 * 8-bit RH-data; 8-bit CRC]
0xF6	6	measure T & RH with medium precision (medium repeatability) [2 * 8-bit T-data; 8-bit CRC; 2 * 8-bit RH-data; 8-bit CRC]
0xE0	6	measure T & RH with lowest precision (low repeatability) [2 * 8-bit T-data; 8-bit CRC; 2 * 8-bit RH-data; 8-bit CRC]
0x89	6	read serial number [2 * 8-bit data; 8-bit CRC; 2 * 8-bit data; 8-bit CRC]
0x94	-	soft reset [ACK]
0x39	6	activate heater with 200mW for 1s, including a high precision measurement just before deactivation [2 * 8-bit T-data; 8-bit CRC; 2 * 8-bit RH-data; 8-bit CRC]
0x32	6	activate heater with 200mW for 0.1s including a high precision measurement just before deactivation [2 * 8-bit T-data; 8-bit CRC; 2 * 8-bit RH-data; 8-bit CRC]
0x2F	6	activate heater with 110mW for 1s including a high precision measurement just before deactivation [2 * 8-bit T-data; 8-bit CRC; 2 * 8-bit RH-data; 8-bit CRC]
0x24	6	activate heater with 110mW for 0.1s including a high precision measurement just before deactivation [2 * 8-bit T-data; 8-bit CRC; 2 * 8-bit RH-data; 8-bit CRC]
0x1E	6	activate heater with 20mW for 1s including a high precision measurement just before deactivation [2 * 8-bit T-data; 8-bit CRC; 2 * 8-bit RH-data; 8-bit CRC]
0x15	6	activate heater with 20mW for 0.1s including a high precision measurement just before deactivation [2 * 8-bit T-data; 8-bit CRC; 2 * 8-bit RH-data; 8-bit CRC]

**Table 7** Overview of I2C commands. If the sensor is not ready to process a command, e.g. because it is still measuring, it will response with NACK to the I2C read header. Given heater power values are typical and valid for VDD=3.3V.

**4.5 Conversion of Signal Output**

The digital sensor signals correspond to following humidity and temperature values:

$$RH = \left( -6 + 125 \cdot \frac{S_{RH}}{2^{16} - 1} \right) \%RH \tag{1}$$

$$T = \left( -45 + 175 \cdot \frac{S_T}{2^{16} - 1} \right) ^\circ C \tag{2}$$

$$T = \left( -49 + 315 \cdot \frac{S_T}{2^{16} - 1} \right) ^\circ F \tag{3}$$

N.B.: The RH conversion formula (1) allows values to be reported which are outside of the range of 0 %RH ... 100 %RH. Relative humidity values which are smaller than 0 %RH and larger than 100 %RH are non-physical, however these “uncropped” values might be found beneficial in some cases (e.g. when the distribution of the sensors at the measurement boundaries are of interest). For all users who do not want to engage in evaluation of these non-physical values, cropping of the RH signal to the range of 0 %RH ... 100 %RH is advised.

#### 4.6 Serial number

Each sensor has a unique serial number, that is assigned by Sensirion during production. It is stored in the one-time-programmable memory and cannot be manipulated after production. The serial number is accessible via I2C command 0x89 and is transmitted as two 16-bit words, each followed by an 8-bit CRC.

#### 4.7 Reset & Abort

A reset of the sensor can be achieved in three ways:

- Soft reset: send the reset command described in **Table 7**.
- I2C general call reset: all devices on I2C bus are reset by sending the command 0x06 to the I2C address 0x00.
- Power down (incl. pulling SCL and SDA low)

Any command that triggers an action at the sensor can be aborted via I2C general call reset or soft reset.

#### 4.8 Heater Operation

The sensor incorporates an integrated on-chip heater which can be switched on by the set of commands given in **Table 7**. Three heating powers and two heating durations are selectable. After reception of a heater-on command, the sensor executes the following procedure:

1. The heater is enabled and the timer starts its count-down
2. On timer expiration a temperature and humidity measurement with the highest repeatability is started, the heater remains enabled
3. After the measurement is finished the heater is turned off
4. Temperature and humidity values are now available

The maximum on-time of the heater commands is 1 second, in order to prevent overheating of the sensor by unintended usage of the heater. Thus, there is no dedicated command to turn off the heater. For extended heating periods it is required to send periodic heater-on commands, keeping in mind that the heater is designed for a maximal duty cycle of less than 5%. To obtain a fast increase in temperature the idle time between consecutive heating pulses shall be kept minimal.

#### Possible Heater Use Cases

There will be dedicated Sensirion application notes elaborating on various use cases of the heater. In general, the applications of the on-chip heater range around:

1. Removal of condensed / spray water on the sensor surface. Although condensed water is not a reliability / quality problem to the sensor, it will however make the sensor non-responsive to RH changes in the air as long as there is liquid water on the surface.
2. Creep-free operation in high humid environments. Periodic heating pulses allow for creep-free high-humidity measurements for extended times.

#### Important notes for operating the heater:

1. The heater is designed for a maximum duty cycle of 5%, meaning the total heater-on-time should not be longer than 5% of the sensor's lifetime.
2. During operation of the heater, sensor specifications are not valid.
3. The temperature sensor can additionally be affected by the thermally induced mechanical stress, offsetting the temperature reading from the actual temperature.
4. The sensor's temperature (base temperature + temperature increase from heater) must not exceed  $T_{max} = 125\text{ °C}$  in order to have proper electrical functionality of the chip.
5. The heater draws a large amount of current once enabled (up to ~75mA in the highest power setting). Although a dedicated circuitry draws this current smoothly, the power

supply has to be strong enough to avoid large voltage drops that could provoke a sensor reset.

If higher heating temperatures are desired, consecutive heating commands have to be sent to the sensor. The heater shall only be operated in ambient temperatures below 65°C else it could drive the sensor outside of its maximal operating temperature.

## 5 Physical Specification

### 5.1 Package Description

SHT4x is provided in an open-cavity dual flat no lead (DFN) package. The humidity sensor opening is centered on the top side of the package. The sensor chip is made of silicon, hosted on a copper lead frame and overmolded by an epoxy-based mold compound. Exposed bottom side of the leadframe with the metallic contacts is Ni/Pd/Au coated, side walls are bare copper.

Moisture sensitivity level (MSL) of 1 according to IPC/JEDEC J-STD-020 is achieved. It is recommended to process the sensors within one year after date of delivery.

### 5.2 Package Outline

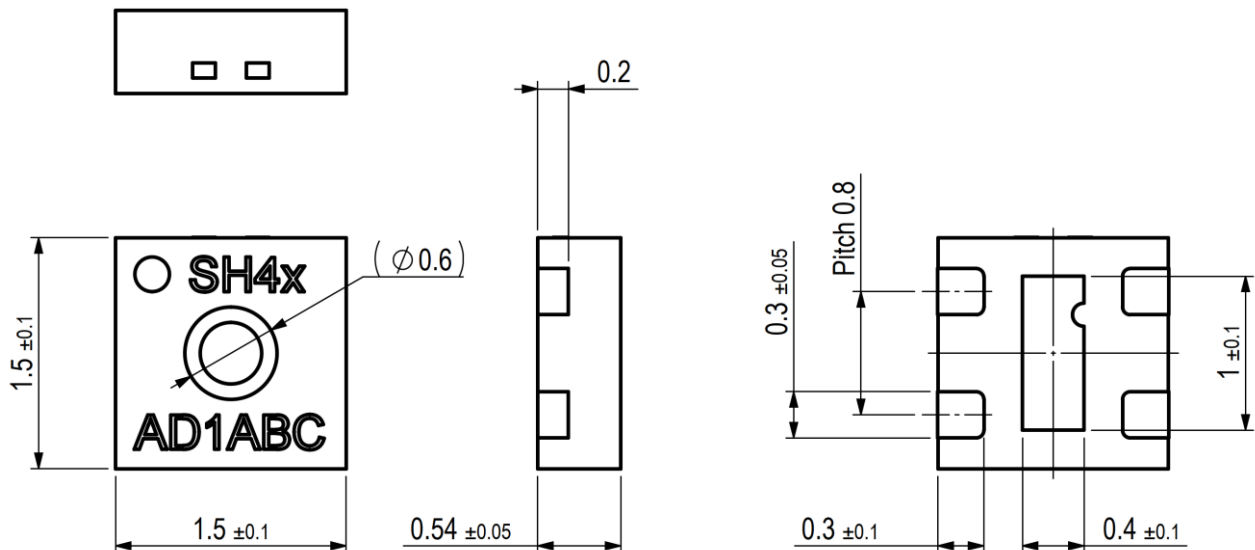
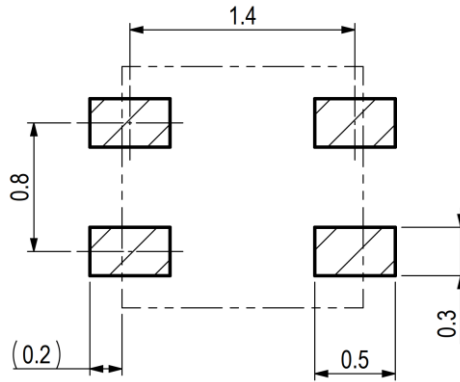

**Figure 9** Dimensional drawing of SHT4x including package tolerances (units mm).

### 5.3 Land Pattern

The land pattern is recommended to be designed according to the used PCB and soldering process together with the physical outer dimensions of the sensor. For reference, the land pattern used with Sensirion’s PCBs and soldering processes is given in **Figure 10**.

Soldering of the central die pad is optional. Sensirion recommends to not solder the central die pad because the sensor can reach higher temperatures upon heater activation.



**Figure 10:** Recommended land pattern (in mm). Details can vary and depend on used PCBs and solder processes. There shall be no copper under the sensor other than at the pin pads.

**5.4 Pin Assignment & Laser Marking**

Pin	Name	Comments
1	SDA	Serial data, bidirectional
2	SCL	Serial clock, unidirectional input
3	VDD	Supply voltage
4	VSS	Ground

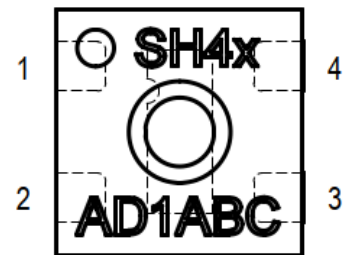

**Figure 11** Pin assignment (transparent top view). Dashed lines are only visible if sensor is viewed from below. The die pad is not directly connected to any pin.

The laser marking consists of two lines, indicated in **Figure 11**. In the first line a filled circle serves as pin-1 indicator and is followed by “SH4”. The last character will indicate the accuracy class of this product (here “x” serves as place holder). In the second line, the first three characters specify the product characteristics according to positions 7,8 and 9 of **Table 9**. The second three characters serve as internal batch tracking code.

**5.5 Thermal Information**

Symbol	Description	Heater off, die pad soldered (K/W)	Heater on, die pad soldered (K/W)	Heater off, die pad not soldered (K/W)	Heater on, die pad not soldered (K/W)
$R_{\theta JA}$	Junction-to-ambient thermal resistance	246	308	<b>297</b>	<b>357</b>
$R_{\theta JC}$	Junction-to-case thermal resistance	189	255	<b>191</b>	<b>257</b>
$R_{\theta JB}$	Junction-to-board thermal resistance	159	225	<b>193</b>	<b>258</b>
$\Psi_{JB}$	Junction-to-board characterization param.	159	223	<b>191</b>	<b>254</b>
$\Psi_{JT}$	Junction-to-top characterization param.	38	105	<b>44</b>	<b>112</b>

**Table 8** Typical values for thermal metrics. In the “heater on” columns a heater power of 200 mW was assumed. Soldering of the die pad is not recommended, therefore the two right hand side columns are bold. Values are based on simulation.

**6 Quality and Material Contents**

Qualification of SHT4x is performed based on the JEDEC JESD47 qualification test method, qualification report available on request. The device is fully RoHS and WEEE compliant, e.g. free of Pb, Cd, and Hg.  
 For general remarks of best practice in processing humidity sensor please refer to the handling instructions (Sensirion, 2020).

**7 Tape and Reel Packaging**

All specifications for the tape and reel packaging can be found on **Figure 12**. Reel diameters are 13 inch and 8 inch for the 10k and the 2.5k packaging sizes, respectively.

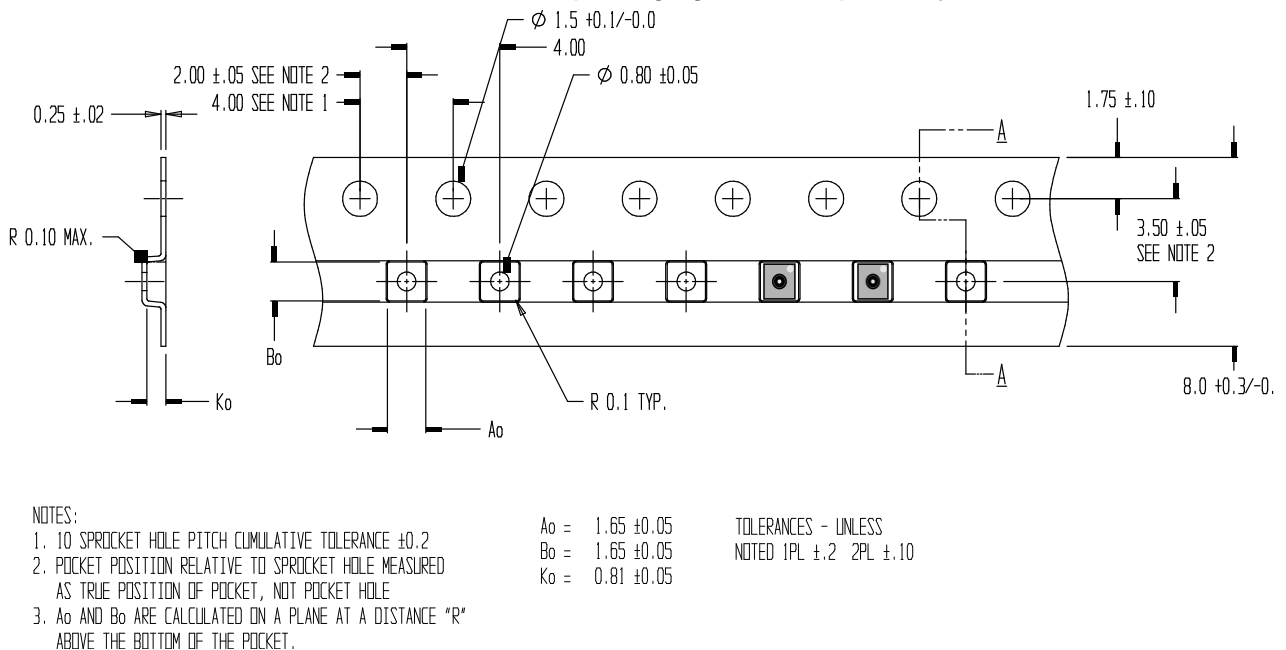

**Figure 12:** Tape and reel specifications including sensor orientation in pocket (see indication of two sensors on the right side of the tape).

## 8 Product Name Nomenclature

position	value(s)	explanation
1	S	Sensirion
2	H	Humidity Signal
3	T	Temperature Signal
4	4	Fourth product generation
5	0 1 5	Base accuracy Intermediate accuracy Best accuracy
6	-	delimiter
7	A B	I2C interface with 0x44 address I2C interface with 0x45 address
8	D	DFN package
9	1	reserved
10	B	blank package without membrane
11	-	delimiter
12	R	Tape on reel packaging
13	2 3	Packaging article contains 2'500 pieces Packaging article contains 10'000 pieces

**Table 9** SHT4x product name nomenclature.

## 9 Ordering Information

Material Description	Material Number	Details	Quantity (pcs)
SHT40-AD1B-R2	3.000.465	base RH&T accuracy, 0x44 I2C addr.	2'500
SHT40-AD1B-R3	3.000.353	base RH&T accuracy, 0x44 I2C addr.	10'000
SHT40-BD1B-R2	3.000.492	base RH&T accuracy, 0x45 I2C addr.	2'500
SHT40-BD1B-R3	3.000.610	base RH&T accuracy, 0x45 I2C addr.	10'000
SHT41-AD1B-R2	3.000.466	intermed. RH&T accuracy, 0x44 I2C addr.	2'500
SHT41-AD1B-R3	3.000.611	intermed. RH&T accuracy, 0x44 I2C addr.	10'000
SHT45-AD1B-R2	tbd	<b>Available 2021</b> ±1.5%RH, ±0.1°C acc., 0x44 I2C addr.	2'500
SHT45-AD1B-R3	tbd	<b>Available 2021</b> ±1.5%RH, ±0.1°C acc, 0x44 I2C addr.	10'000

**Table 10** SHT4x ordering options.

## 10 Bibliography

Sensirion. (2020). *Handling Instructions for Humidity Sensors*. Retrieved from [www.sensirion.com](http://www.sensirion.com)

**11 Revision History**

Date	Version	Page(s)	Changes
October 2020	1	all	Initial release
July 2021	2	multiple	Typo correction Included checksum in <b>Figure 1</b> Included description of NIST traceability in section 2 Included repeatability clarification in <b>Table 1</b> Clarified I2C communication in section 4.1 Removed waiting time specification in <b>Table 4</b> Specified serial number in 4.6 Updated qualification status in section 6 Deleted binary com. & included return values in <b>Table 7</b> Updated note on duty cycle of heater in section 4.8 Added note on large current drawn by heater in section 4.8 Updated ordering information in <b>Table 10</b>



## Important Notices

### Warning, Personal Injury

**Do not use this product as safety or emergency stop devices or in any other application where failure of the product could result in personal injury. Do not use this product for applications other than its intended and authorized use. Before installing, handling, using or servicing this product, please consult the data sheet and application notes. Failure to comply with these instructions could result in death or serious injury.**

If the Buyer shall purchase or use SENSIRION products for any unintended or unauthorized application, Buyer shall defend, indemnify and hold harmless SENSIRION and its officers, employees, subsidiaries, affiliates and distributors against all claims, costs, damages and expenses, and reasonable attorney fees arising out of, directly or indirectly, any claim of personal injury or death associated with such unintended or unauthorized use, even if SENSIRION shall be allegedly negligent with respect to the design or the manufacture of the product.

### ESD Precautions

The inherent design of this component causes it to be sensitive to electrostatic discharge (ESD). To prevent ESD-induced damage and/or degradation, take customary and statutory ESD precautions when handling this product. See application note "ESD, Latchup and EMC" for more information.

### Warranty

SENSIRION warrants solely to the original purchaser of this product for a period of 12 months (one year) from the date of delivery that this product shall be of the quality, material and workmanship defined in SENSIRION's published specifications of the product. Within such period, if proven to be defective, SENSIRION shall repair and/or replace this product, in SENSIRION's discretion, free of charge to the Buyer, provided that:

- notice in writing describing the defects shall be given to SENSIRION within fourteen (14) days after their appearance;
- such defects shall be found, to SENSIRION's reasonable satisfaction, to have arisen from SENSIRION's faulty design, material, or workmanship;
- the defective product shall be returned to SENSIRION's factory at the Buyer's expense; and
- the warranty period for any repaired or replaced product shall be limited to the unexpired portion of the original period.

This warranty does not apply to any equipment which has not been installed and used within the specifications recommended by SENSIRION for the intended and proper use of the equipment. EXCEPT FOR THE WARRANTIES EXPRESSLY SET FORTH HEREIN, SENSIRION MAKES NO WARRANTIES, EITHER EXPRESS OR IMPLIED, WITH RESPECT TO THE PRODUCT. ANY AND ALL WARRANTIES, INCLUDING WITHOUT LIMITATION, WARRANTIES OF MERCHANTABILITY OR FITNESS FOR A PARTICULAR PURPOSE, ARE EXPRESSLY EXCLUDED AND DECLINED.

SENSIRION is only liable for defects of this product arising under the conditions of operation provided for in the data sheet and proper use of the goods. SENSIRION explicitly disclaims all warranties, express or implied, for any period during which the goods are operated or stored not in accordance with the technical specifications.

SENSIRION does not assume any liability arising out of any application or use of any product or circuit and specifically disclaims any and all liability, including without limitation consequential or incidental damages. All operating parameters, including without limitation recommended parameters, must be validated for each customer's applications by customer's technical experts. Recommended parameters can and do vary in different applications.

SENSIRION reserves the right, without further notice, (i) to change the product specifications and/or the information in this document and (ii) to improve reliability, functions and design of this product.

Copyright © 2021, by SENSIRION. CMOSens® is a trademark of Sensirion. All rights reserved

## Headquarters and Subsidiaries

### Sensirion AG

Laubisruetistr. 50  
CH-8712 Staefa ZH  
Switzerland

phone: +41 44 306 40 00  
fax: +41 44 306 40 30  
[info@sensirion.com](mailto:info@sensirion.com)  
[www.sensirion.com](http://www.sensirion.com)

### Sensirion Taiwan Co. Ltd

phone: +886 3 5506701  
[info@sensirion.com](mailto:info@sensirion.com)  
[www.sensirion.com](http://www.sensirion.com)

### Sensirion Inc., USA

phone: +1 312 690 5858  
[info-us@sensirion.com](mailto:info-us@sensirion.com)  
[www.sensirion.com](http://www.sensirion.com)

### Sensirion Japan Co. Ltd.

phone: +81 3 3444 4940  
[info-jp@sensirion.com](mailto:info-jp@sensirion.com)  
[www.sensirion.com/jp](http://www.sensirion.com/jp)

### Sensirion Korea Co. Ltd.

phone: +82 31 337 7700~3  
[info-kr@sensirion.com](mailto:info-kr@sensirion.com)  
[www.sensirion.com/kr](http://www.sensirion.com/kr)

### Sensirion China Co. Ltd.

phone: +86 755 8252 1501  
[info-cn@sensirion.com](mailto:info-cn@sensirion.com)  
[www.sensirion.com/cn](http://www.sensirion.com/cn)

To find your local representative, please visit [www.sensirion.com/distributors](http://www.sensirion.com/distributors)