

## Optional DIN-Rail mounting kit

Order code	TMP-MK2
------------	---------

Weight: 59 g (without converter)

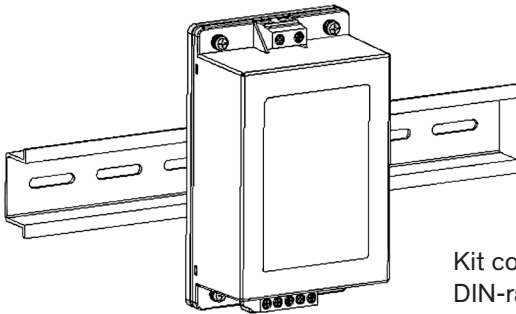

Kit contains interface plate, DIN-rail clip and screws

