

**tyco** / *Electronics*



**Greenpar RF Connectors**  
**SMA & SMA.com Connectors 50 Ohm**

**Table of Contents**

Introduction .....	3
Connector Specifications .....	4
SMA Semi-Rigid Straight Plugs 50 Ohm .....	5
SMA Semi-Rigid Elbow Plugs 50 Ohm .....	5
SMA Semi-Rigid Straight Jacks 50 Ohm .....	6
SMA Semi-Rigid Bulkhead Jacks 50 Ohm .....	6
SMA Semi-Rigid Panel Jacks, 4-Hole Flange 50 Ohm .....	6
SMA Semi-Rigid Panel Jacks, 2-Hole Flange 50 Ohm .....	6
SMA Straight Plugs Crimp 50 Ohm .....	7
SMA Straight Plugs Mil-Crimp 50 Ohm .....	8
SMA Straight Plugs Solder/Clamp 50 Ohm .....	8
SMA Elbow Plugs Crimp 50 Ohm .....	9
SMA Elbow Plugs, Solder/Clamp 50 Ohm .....	10
SMA Straight Jacks Crimp 50 Ohm .....	11
SMA Straight Jacks Mil-Crimp 50 Ohm .....	12
SMA Panel Jacks 4-Hole Mil-Crimp 50 Ohm .....	13
SMA Straight Jacks Solder/Clamp 50 Ohm .....	14
SMA Panel Jacks 4-Hole Solder/Clamp 50 Ohm .....	15
SMA Bulkhead Jacks Crimp 50 Ohm .....	16
SMA Bulkhead Jacks Mil-Crimp 50 Ohm .....	17
SMA Bulkhead Jacks Solder/Clamp 50 Ohm .....	18
SMA Elbow PCB Socket 50 Ohm .....	18
SMA Straight PCB Socket 50 Ohm .....	18
SMA Straight Adaptors Plug - Plug 50 Ohm .....	19
SMA Straight Adaptors Jack - Jack 50 Ohm .....	19
SMA Straight Adaptors Plug - Jack 50 Ohm .....	19
SMA Elbow Adaptor Plug - Jack 50 Ohm .....	20
SMA Bulkhead Adaptor Jack - Jack 50 Ohm .....	20
SMA Bulkhead Sockets 50 Ohm .....	20
SMA Panel Plug 4-Hole 50 Ohm .....	21
SMA Panel Socket 4-Hole 50 Ohm .....	21
SMA Panel Socket 2-Hole 50 Ohm .....	21
SMA Elbow Panel Socket 4-Hole 50 Ohm .....	21
SMA Panel Socket Launcher 4-Hole 50 Ohm .....	22
SMA Panel Socket Launcher 2-Hole 50 Ohm .....	22
SMA Panel Socket Launcher 2-Hole Microstrip 50 Ohm .....	22
SMA Panel Socket Launcher 2-Hole Tab Contact 50 Ohm .....	23
SMA Panel Socket Launcher 4-Hole Stub Contact 50 Ohm .....	23
SMA Panel Socket Launcher 4-Hole Tab Contact 50 Ohm .....	23
SMA Panel Socket Launcher 4-Hole Slotted Contact 50 Ohm .....	24
SMA Plug Dust Cap & Chain .....	24
SMA Jack Dust Cap & Chain .....	24
SMA Plug Termination, 1 Watt, 50 Ohm .....	25
SMA Jack Termination, 1 Watt, 50 Ohm .....	25
SMA Die Sets .....	25
SMA Hand Tool .....	25
SMA Adaptors .....	26-28
Part Number Index .....	29

**Product Facts**

- Available in various base metal options, including stainless steel, brass and zinc diecast
- Flexible and Semi Rigid cable compatibility
- Performance to 6 GHz for brass, 12.4 GHz for stainless steel and 18 Ghz for Semi Rigid
- Options include crimp, solder clamp and direct solder attachment types
- Fully intermateable with MIL-C-39012 products
- Connectors are available in gold, passivated and white bronze finishes
- Meets the electrical and mechanical design requirement of MIL-C-39012
- Industry standard crimp tools and processes



The Tyco Greenpar SMA series offers a broad range of styles to meet professional and commercial applications.

This covers straight & right angled cable attached plugs, bulkhead & panel mount with 2 and 4 hole flanges, straight & right angled PCB mounted jacks.

Crimp styles also offer the rapid fit 3-part assembly to ensure the lowest applied cost.

In addition the range includes panel mounted receptacles and MIC plug & socket launching.

Available are in-series & between series adaptors with differing combinations.

The stainless steel body with threaded coupling provides optimum performance under demanding conditions.

**SMA Connector Specifications**

Characteristics	SMA Stainless Steel Body		SMA Brass Body	
	Gold/Gold	Gold/Passivated	Gold/Gold	Gold/White Bronze
<b>Electrical</b>				
Impedance, Nom. (Ohms)	50			
Working Voltage (Volts RMS)	Semi-Rigid - RG402: 500v RG405: 335v Flexible Cable - RG55/58: 500v RG174: 335v			
Contact Resistance (Milliohms)	Straight: 3 milliohms Elbow - 4 milliohms Outer Contact - 2.0 milliohms			
Initial Insulation Resistance (Megohms)	5000 min			
Dielectric Withstanding Voltage (VAC) RMS Sea Level	Semi Rigid - RG402: 1.5Kv RG 405: 1.0Kv Flexible Cable - RG55/58: 1000v RG174: 750v			
RF Insertion Loss, Max. (dB)	Straight 0.06 Max. at 6.0 GHz Right Angle 0.15 Max. at 6.0 GHz			
Frequency Range (GHz)	Stainless Steel Gold: DC-18 GHz (Elbow 12.4) Passivated: DC-12.4 GHz Brass Gold: DC-6 GHz			
VSWR in Frequency Range @ 4 GHz.	Semi Rigid: Straight 1.05 Elbow 1.10 Flexible Cable: Straight 1.15 Elbow: 1.5			
<b>Mechanical</b>				
Mating Style	Threaded Coupling 0.250" - 36UNS-2A			
Coupling Nut Retention, Min. (N)	267N			
Coupling Nut Proof Torque (N)	Stainless Steel 80-115N Brass 12-60N			
Cable Retention, (N)	RG174/188/316 - 110N RG55U/58/141/142/223/303/400 - 180N			
Durability (Cycles)	500 Matings		100 Matings	
<b>Environmental</b>				
Temperature Range, Operating (°C)	-65 to +165			
Vibration	MIL-STD-202 Method 204 Test Cond. D			
Salt Spray	MIL-STD-202 Method 101 Test Cond. B			
Thermal Shock	MIL-STD-202 Method 107 Test Cond. D			
<b>Material</b>				
Connector Body	Stainless Steel		Brass	
Connector Body Plating	Gold	Passivated	Gold	White Bronze
Centre Contact Male	Plug: Brass			
Centre Contact Male Plating	Gold			
Centre Contact Female	Jack: Beryllium Copper			
Centre Contact Female Plating	Gold			
Insulation	PTFE			
Gasket	Silicon Rubber			
Crimp Ferrule	Annealed Copper			
Crimp Ferrule Plating	As per Body Finish			

Preferred Part

**SMA Connectors 50 Ohm**

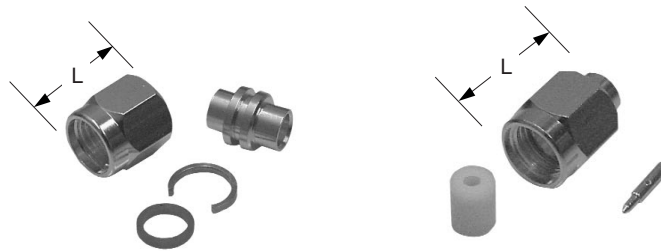

**SMA Semi-Rigid Straight Plugs 50 Ohm**

Style	Connector Cable Range	Termination Type	Centre Contact Plating	Body Material & Finish	Dielectric	Part Number	L Dim.	Assembly Instruction
A	RG402/U	Direct Solder	Gold	Stainless Steel Gold	Teflon	1-1478902-0	11.3	411-3276
		Direct Solder	Gold	Stainless Steel* Passivated	Teflon	2-1478902-0	11.3	
B	RG402/U	Direct Solder	Gold	Stainless Steel Gold	Teflon	1-1478903-0	11.2	411-3276
		Direct Solder	Gold	Stainless Steel* Passivated	Teflon	2-1478903-0	11.2	
		Direct Solder	Gold	Brass, Gold	Teflon	3-1478903-0	11.2	
B	RG405/U	Direct Solder	Gold	Stainless Steel Gold	Teflon	1-1478904-0	11.2	411-3276
		Direct Solder	Gold	Stainless Steel* Passivated	Teflon	2-1478904-0	11.2	
		Direct Solder	Gold	Brass, Gold	Teflon	3-1478904-0	11.2	

\* Cable Entry is Gold Plated for solderability

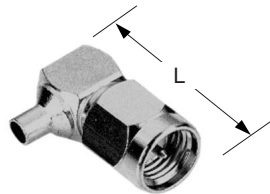

**SMA Semi-Rigid Elbow Plugs 50 Ohm**

Connector Cable Range	Termination Type	Centre Contact Plating	Body Material & Finish	Dielectric	Part Number	L Dim.	Assembly Instruction
RG402/U	Direct Solder	Gold	Stainless Steel Gold	Teflon	1-1478905-0	16.5	411-3276
	Direct Solder	Gold	Stainless Steel* Passivated	Teflon	2-1478905-0	16.5	
	Direct Solder	Gold	Brass, Gold	Teflon	3-1478905-0	16.5	
RG405/U	Direct Solder	Gold	Stainless Steel Gold	Teflon	1-1478906-0	16.5	411-3276
	Direct Solder	Gold	Stainless Steel* Passivated	Teflon	2-1478906-0	16.5	
	Direct Solder	Gold	Brass, Gold	Teflon	3-1478906-0	16.5	

\* Cable Entry is Gold Plated for solderability

Preferred Part

**SMA Connectors 50 Ohm**

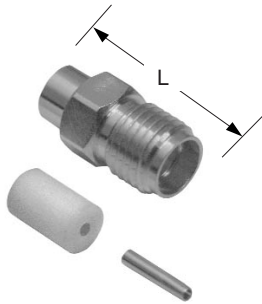

**SMA Semi-Rigid Straight Jacks 50 Ohm**

Connector Cable Range	Termination Type	Centre Contact Plating	Body Material & Finish	Dielectric	Part Number	L Dim.	Assembly Instruction
RG402/U	Direct Solder	Gold	Stainless Steel Gold	Teflon	1-1478928-0	12.7	411-3276
	Direct Solder	Gold	Brass, Gold	Teflon	3-1478928-0	12.7	
RG405/U	Direct Solder	Gold	Stainless Steel Gold	Teflon	1-1478929-0	12.7	411-3276
	Direct Solder	Gold	Brass, Gold	Teflon	3-1478929-0	12.7	

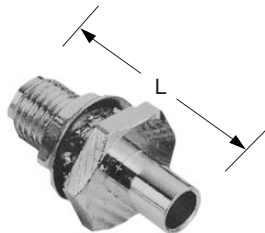

**SMA Semi-Rigid Bulkhead Jacks 50 Ohm**

Connector Cable Range	Termination Type	Centre Contact Plating	Body Material & Finish	Dielectric	Part Number	L Dim.	Assembly Instruction
RG402/U	Direct Solder	Gold	Stainless Steel Gold	Teflon	1-1478987-0	16.0	411-3276
	Direct Solder	Gold	Brass, Gold	Teflon	3-1478987-0	16.0	
RG405/U	Direct Solder	Gold	Stainless Steel Gold	Teflon	1-1478988-0	16.0	411-3276
	Direct Solder	Gold	Brass, Gold	Teflon	3-1478988-0	16.0	

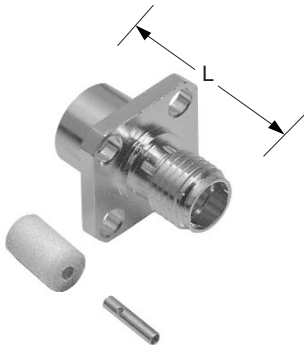

**SMA Semi-Rigid Panel Jacks, 4-Hole Flange 50 Ohm**

Connector Cable Range	Termination Type	Centre Contact Plating	Body Material & Finish	Dielectric	Part Number	L Dim.	Assembly Instruction
RG402/U	Direct Solder	Gold	Stainless Steel Gold	Teflon	1-1478930-0	12.7	411-3276
RG405/U	Direct Solder	Gold	Stainless Steel Gold	Teflon	1-1478931-0	12.7	411-3276

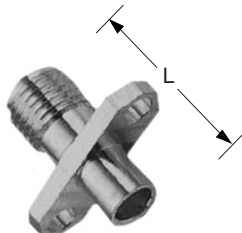

**SMA Semi-Rigid Panel Jacks, 2-Hole Flange 50 Ohm**

Connector Cable Range	Termination Type	Centre Contact Plating	Body Material & Finish	Dielectric	Part Number	L Dim.	Assembly Instruction
RG402/U	Direct Solder	Gold	Stainless Steel Gold	Teflon	1-1478932-0	12.7	411-3276
RG405/U	Direct Solder	Gold	Stainless Steel Gold	Teflon	1-1478933-0	12.7	411-3276

Preferred Part

**SMA Connectors 50 Ohm**

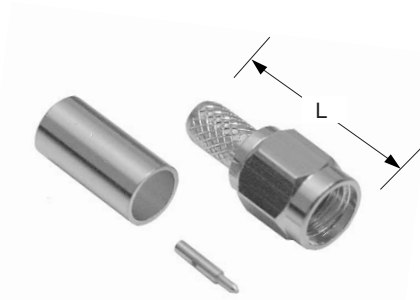

**SMA Straight Plugs Crimp 50 Ohm**

Connector Cable Range	Termination Type	Centre Contact Plating	Body Material & Finish	Dielectric	Part Number	L Dim.	Interchangeable Die Hand Tool	Interchangeable Die Set	Assembly Instruction
RG174A/U 188A/U 316/U URM95 KX3B, KX22B	Hex Crimp	Gold	Stainless Steel Gold	Teflon	1-1478916-0	17.8	9-1478240-0	9-1478248-0	411-3276
	Hex Crimp	Gold	Stainless Steel Passivated	Teflon	2-1478916-0	17.8	9-1478240-0	9-1478248-0	
	Hex Crimp	Gold	Brass, Gold	Teflon	3-1478916-0	17.8	9-1478240-0	9-1478248-0	
	Hex Crimp	Gold	Brass White Bronze	Teflon	4-1478916-0	17.8	9-1478240-0	9-1478248-0	
RD316	Hex Crimp	Gold	Stainless Steel Gold	Teflon	4-1478916-0	17.8	9-1478240-0	9-1478248-0	411-3276
	Hex Crimp	Gold	Stainless Steel Passivated	Teflon	1-1478918-0	17.8	9-1478240-0	9-1478248-0	
	Hex Crimp	Gold	Brass, Gold	Teflon	2-1478918-0	17.8	9-1478240-0	9-1478248-0	
	Hex Crimp	Gold	Brass White Bronze	Teflon	3-1478918-0	17.8	9-1478240-0	9-1478248-0	
RG55B/U 142B/U 223/U 400/U KX23	Hex Crimp	Gold	Stainless Steel Gold	Teflon	1-1478917-0	17.8	9-1478240-0	9-1478242-0	411-3276
	Hex Crimp	Gold	Stainless Steel Passivated	Teflon	2-1478917-0	17.8	9-1478240-0	9-1478242-0	
	Hex Crimp	Gold	Brass, Gold	Teflon	3-1478917-0	17.8	9-1478240-0	9-1478242-0	
	Hex Crimp	Gold	Brass White Bronze	Teflon	4-1478917-0	17.8	9-1478240-0	9-1478242-0	
RG58C/U 141A/U URM43 URM76 KX15	Hex Crimp	Gold	Stainless Steel Gold	Teflon	1-1478915-0	17.8	9-1478240-0	9-1478242-0	411-3276
	Hex Crimp	Gold	Stainless Steel Passivated	Teflon	2-1478915-0	17.8	9-1478240-0	9-1478242-0	
	Hex Crimp	Gold	Brass, Gold	Teflon	3-1478915-0	17.8	9-1478240-0	9-1478242-0	
	Hex Crimp	Gold	Brass White Bronze	Teflon	4-1478915-0	17.8	9-1478240-0	9-1478242-0	

 Preferred Part

**SMA Connectors 50 Ohm**

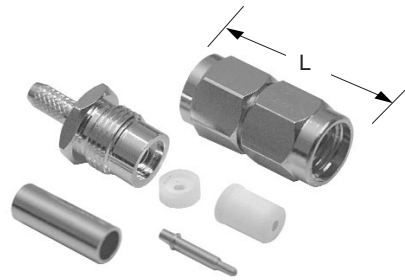

**SMA Straight Plugs Mil-Crimp 50 Ohm**

Connector Cable Range	Termination Type	Centre Contact Plating	Body Material & Finish	Dielectric	Part Number	L Dim.	Interchangeable Die Hand Tool	Interchangeable Die Set	Assembly Instruction
RD316	Hex Crimp	Gold	Stainless Steel Gold	Teflon	1-1478922-0	25.2	9-1478240-0	9-1478248-0	411-3276
	Hex Crimp	Gold	Stainless Steel Passivated	Teflon	2-1478922-0	25.2	9-1478240-0	9-1478248-0	
RG55B/U, 142B/U 223/U, 400/U KX23	Hex Crimp	Gold	Stainless Steel Gold	Teflon	1-1478921-0	25.2	9-1478240-0	9-1478248-0	411-3276
	Hex Crimp	Gold	Stainless Steel Passivated	Teflon	2-1478921-0	25.2	9-1478240-0	9-1478248-0	

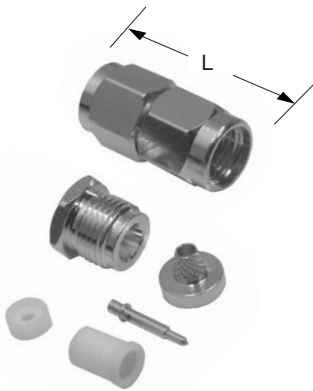

**SMA Straight Plugs Solder/Clamp 50 Ohm**

Connector Cable Range	Termination Type	Centre Contact Plating	Body Material & Finish	Dielectric	Part Number	L Dim.	Assembly Instruction
RG178B/U	Solder/Clamp	Gold	Stainless Steel Gold	Teflon	1-1478909-0	22.8	411-3276
196A/U URM110	Solder/Clamp	Gold	Stainless Steel Passivated	Teflon	2-1478909-0	22.8	
RG174A/U, 188A/U 316/U, URM95 KX3B, KX22B	Solder/Clamp	Gold	Stainless Steel Gold	Teflon	1-1478908-0	22.8	411-3276
	Solder/Clamp	Gold	Stainless Steel Passivated	Teflon	2-1478908-0	22.8	
RD316	Solder/Clamp	Gold	Stainless Steel Gold	Teflon	cso	22.8	411-3276
	Solder/Clamp	Gold	Stainless Steel Passivated	Teflon	cso	22.8	
RG55B/U, 142B/U 223/U, 400/U KX23	Solder/Clamp	Gold	Stainless Steel Gold	Teflon	1-1478910-0	27.0	411-3276
	Solder/Clamp	Gold	Stainless Steel Passivated	Teflon	2-1478910-0	27.0	
RG58C/U, 141A/U URM43, URM76 KX15	Solder/Clamp	Gold	Stainless Steel Gold	Teflon	1-1478907-0	27.0	411-3276
	Solder/Clamp	Gold	Stainless Steel Passivated	Teflon	2-1478907-0	27.0	

Preferred Part



**SMA Connectors 50 Ohm**

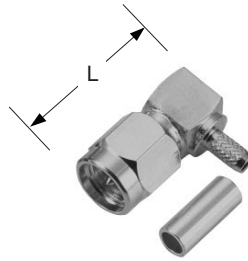

**SMA Elbow Plugs Crimp 50 Ohm**

Connector Cable Range	Termination Type	Centre Contact Plating	Body Material & Finish	Dielectric	Part Number	L Dim.	Interchangeable Die Hand Tool	Interchangeable Die Set	Assembly Instruction
RG178B/U 196A/U URM110	Hex Crimp	Gold	Stainless Steel Gold	Teflon	1-1478925-0	16.5	9-1478240-0	9-1478248-0	411-3276
	Hex Crimp	Gold	Stainless Steel Passivated	Teflon	2-1478925-0	16.5	9-1478240-0	9-1478248-0	
	Hex Crimp	Gold	Brass, Gold	Teflon	3-1478925-0	16.5	9-1478240-0	9-1478248-0	
	Hex Crimp	Gold	Brass White Bronze	Teflon	4-1478925-0	16.5	9-1478240-0	9-1478248-0	
RG174A/U 188A/U 316/U URM95 KX3B KX22A	Hex Crimp	Gold	Stainless Steel Gold	Teflon	1-1478924-0	16.5	9-1478240-0	9-1478248-0	411-3276
	Hex Crimp	Gold	Stainless Steel Passivated	Teflon	2-1478924-0	16.5	9-1478240-0	9-1478248-0	
	Hex Crimp	Gold	Brass, Gold	Teflon	3-1478924-0	16.5	9-1478240-0	9-1478248-0	
	Hex Crimp	Gold	Brass White Bronze	Teflon	4-1478924-0	16.5	9-1478240-0	9-1478248-0	
RD316	Hex Crimp	Gold	Stainless Steel Gold	Teflon	cso	16.5	9-1478240-0	9-1478248-0	411-3276
	Hex Crimp	Gold	Stainless Steel Passivated	Teflon	cso	16.5	9-1478240-0	9-1478248-0	
	Hex Crimp	Gold	Brass, Gold	Teflon	3-1478927-0	16.5	9-1478240-0	9-1478248-0	
	Hex Crimp	Gold	Brass White Bronze	Teflon	4-1478927-0	16.5	9-1478240-0	9-1478248-0	
RG55B/U 142B/U 223/U 400/N KX23	Hex Crimp	Gold	Stainless Steel Gold	Teflon	1-1478926-0	16.5	9-1478240-0	9-1478242-0	411-3276
	Hex Crimp	Gold	Stainless Steel Passivated	Teflon	2-1478926-0	16.5	9-1478240-0	9-1478242-0	
	Hex Crimp	Gold	Brass, Gold	Teflon	3-1478926-0	16.5	9-1478240-0	9-1478242-0	
	Hex Crimp	Gold	Brass White Bronze	Teflon	4-1478926-0	16.5	9-1478240-0	9-1478242-0	
RG58C/U 141A/U URM43,76 KX15	Hex Crimp	Gold	Stainless Steel Gold	Teflon	1-1478923-0	16.5	9-1478240-0	9-1478242-0	411-3276
	Hex Crimp	Gold	Stainless Steel Passivated	Teflon	2-1478923-0	16.5	9-1478240-0	9-1478242-0	
	Hex Crimp	Gold	Brass, Gold	Teflon	3-1478923-0	16.5	9-1478240-0	9-1478242-0	
	Hex Crimp	Gold	Brass White Bronze	Teflon	4-1478923-0	16.5	9-1478240-0	9-1478242-0	

Preferred Part

**SMA Connectors 50 Ohm**

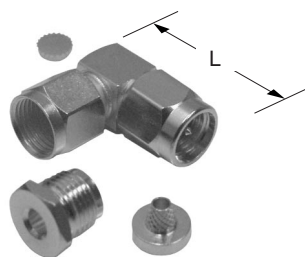

**SMA Elbow Plugs, Solder/Clamp 50 Ohm**

Connector Cable Range	Termination Type	Centre Contact Plating	Body Material & Finish	Dielectric	Part Number	L Dim.	Assembly Instruction
RG178B/U	Solder/Clamp	Gold	Stainless Steel Gold	Teflon	1-1478913-0	16.7	411-3276
196A/U URM110	Solder/Clamp	Gold	Stainless Steel Passivated	Teflon	2-1478913-0	16.7	
RG174A/U, 188 A/U 316/U, URM95	Solder/Clamp	Gold	Stainless Steel Gold	Teflon	1-1478912-0	16.7	411-3276
KX3B KX22A	Solder/Clamp	Gold	Stainless Steel Passivated	Teflon	2-1478912-0	16.7	
RD316	Solder/Clamp	Gold	Stainless Steel Gold	Teflon	CSO	16.7	411-3276
	Solder/Clamp	Gold	Stainless Steel Passivated	Teflon	CSO	16.7	
RG55B/U, 142B/U 223/U, 400/U	Solder/Clamp	Gold	Stainless Steel Gold	Teflon	1-1478914-0	16.7	411-3276
	KX23	Solder/Clamp	Stainless Steel Passivated	Teflon	2-1478914-0	16.7	
RG58C/U, 141A/U URM43, 76	Solder/Clamp	Gold	Stainless Steel Gold	Teflon	1-1478911-0	16.7	411-3276
	KX15	Solder/Clamp	Stainless Steel Passivated	Teflon	2-1478911-0	16.7	

Preferred Part

**SMA Connectors 50 Ohm**

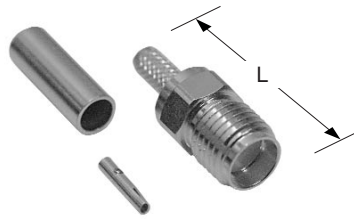

**SMA Straight Jacks Crimp 50 Ohm**

Connector Cable Range	Termination Type	Centre Contact Plating	Body Material & Finish	Dielectric	Part Number	L Dim.	Interchangeable Die Hand Tool	Interchangeable Die Set	Assembly Instruction
RG174A/U 188A/U 316/U URM95 KX3B KX22A	Hex Crimp	Gold	Stainless Steel Gold	Teflon	1-1478943-0	16.2	9-1478240-0	9-1478248-0	411-3276
	Hex Crimp	Gold	Stainless Steel Passivated	Teflon	2-1478943-0	16.2	9-1478240-0	9-1478248-0	
	Hex Crimp	Gold	Brass, Gold	Teflon	3-1478943-0	16.2	9-1478240-0	9-1478248-0	
	Hex Crimp	Gold	Brass White Bronze	Teflon	4-1478943-0	16.2	9-1478240-0	9-1478248-0	
RD316	Hex Crimp	Gold	Stainless Steel Gold	Teflon	cso	16.2	9-1478240-0	9-1478248-0	411-3276
	Hex Crimp	Gold	Stainless Steel Passivated	Teflon	cso	16.2	9-1478240-0	9-1478248-0	
	Hex Crimp	Gold	Brass, Gold	Teflon	3-1478945-0	16.2	9-1478240-0	9-1478248-0	
	Hex Crimp	Gold	Brass White Bronze	Teflon	4-1478945-0	16.2	9-1478240-0	9-1478248-0	
RG55B/U 142B/U 223/U 400/U KX23	Hex Crimp	Gold	Stainless Steel Gold	Teflon	1-1478944-0	16.2	9-1478240-0	9-1478242-0	411-3276
	Hex Crimp	Gold	Stainless Steel Passivated	Teflon	2-1478944-0	16.2	9-1478240-0	9-1478242-0	
	Hex Crimp	Gold	Brass, Gold	Teflon	3-1478944-0	16.2	9-1478240-0	9-1478242-0	
	Hex Crimp	Gold	Brass White Bronze	Teflon	4-1478944-0	16.2	9-1478240-0	9-1478242-0	
RG58C/U 141A/U URM43, 76 KX15	Hex Crimp	Gold	Stainless Steel Gold	Teflon	1-1478942-0	16.2	9-1478240-0	9-1478242-0	411-3276
	Hex Crimp	Gold	Stainless Steel Passivated	Teflon	2-1478942-0	16.2	9-1478240-0	9-1478242-0	
	Hex Crimp	Gold	Brass, Gold	Teflon	3-1478942-0	16.2	9-1478240-0	9-1478242-0	
	Hex Crimp	Gold	Brass White Bronze	Teflon	4-1478942-0	16.2	9-1478240-0	9-1478242-0	

Preferred Part

**SMA Connectors 50 Ohm**



**SMA Straight Jacks Mil-Crimp 50 Ohm**

Connector Cable Range	Termination Type	Centre Contact Plating	Body Material & Finish	Dielectric	Part Number	L Dim.	Interchangeable Die Hand Tool	Interchangeable Die Set	Assembly Instruction
RG178B/U 196A/U URM110	Hex Crimp	Gold	Stainless Steel Gold	Teflon	1-1478948-0	24.1	9-1478240-0	9-1478248-0	411-3276
	Hex Crimp	Gold	Stainless Steel Passivated	Teflon	2-1478948-0	24.1	9-1478240-0	9-1478248-0	
RG174A/U 188A/U, 316/U URM95, KX3B KX22A	Hex Crimp	Gold	Stainless Steel Gold	Teflon	1-1478947-0	24.1	9-1478240-0	9-1478248-0	411-3276
	Hex Crimp	Gold	Stainless Steel Passivated	Teflon	2-1478947-0	24.1	9-1478240-0	9-1478248-0	
RD316	Hex Crimp	Gold	Stainless Steel Gold	Teflon	cso	24.1	9-1478240-0	9-1478248-0	411-3276
	Hex Crimp	Gold	Stainless Steel Passivated	Teflon	cso	24.1	9-1478240-0	9-1478248-0	
RG55B/U 142B/U, 223/U 400/U, KX23	Hex Crimp	Gold	Stainless Steel Gold	Teflon	1-1478949-0	24.1	9-1478240-0	9-1478242-0	411-3276
	Hex Crimp	Gold	Stainless Steel Passivated	Teflon	2-1478949-0	24.1	9-1478240-0	9-1478242-0	
RG58C/U 141A/U URM43, 76 KX15	Hex Crimp	Gold	Stainless Steel Gold	Teflon	1-1478946-0	24.1	9-1478240-0	9-1478242-0	411-3276
	Hex Crimp	Gold	Stainless Steel Passivated	Teflon	2-1478946-0	24.1	9-1478240-0	9-1478242-0	

Preferred Part

**SMA Connectors 50 Ohm**

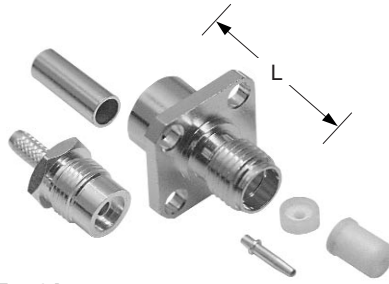

**SMA Panel Jacks 4-Hole Mil-Crimp 50 Ohm**

Connector Cable Range	Termination Type	Centre Contact Plating	Body Material & Finish	Dielectric	Part Number	L Dim.	Interchangeable Die Hand Tool	Interchangeable Die Set	Assembly Instruction
RG178B/U 196A/U URM110	Hex Crimp	Gold	Stainless Steel Gold	Teflon	1-1478952-0	24.1	9-1478240-0	9-1478248-0	411-3276
	Hex Crimp	Gold	Stainless Steel Passivated	Teflon	2-1478952-0	24.1	9-1478240-0	9-1478248-0	
RG174A/U 188A/U, 316/U URM95, KX3B KX22A	Hex Crimp	Gold	Stainless Steel Gold	Teflon	1-1478951-0	24.1	9-1478240-0	9-1478248-0	411-3276
	Hex Crimp	Gold	Stainless Steel Passivated	Teflon	2-1478951-0	24.1	9-1478240-0	9-1478248-0	
RD316	Hex Crimp	Gold	Stainless Steel Gold	Teflon	cso	24.1	9-1478240-0	9-1478248-0	411-3276
	Hex Crimp	Gold	Stainless Steel Passivated	Teflon	cso	24.1	9-1478240-0	9-1478248-0	
RG55B/U, 142B/U 223/U, 400/U KX23	Hex Crimp	Gold	Stainless Steel Gold	Teflon	1-1478953-0	24.1	9-1478240-0	9-1478242-0	411-3276
	Hex Crimp	Gold	Stainless Steel Passivated	Teflon	2-1478953-0	24.1	9-1478240-0	9-1478242-0	
RG58C/U 141A/U URM43, 76 KX15	Hex Crimp	Gold	Stainless Steel Gold	Teflon	1-1478950-0	24.1	9-1478240-0	9-1478242-0	411-3276
	Hex Crimp	Gold	Stainless Steel Passivated	Teflon	2-1478950-0	24.1	9-1478240-0	9-1478242-0	

Preferred Part

**SMA Connectors 50 Ohm**

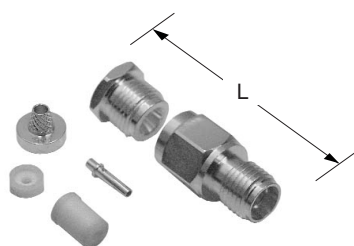

**SMA Straight Jacks Solder/Clamp 50 Ohm**

Connector Cable Range	Termination Type	Centre Contact Plating	Body Material & Finish	Dielectric	Part Number	L Dim.	Assembly Instruction
RG178B/U	Solder/Clamp	Gold	Stainless Steel Gold	Teflon	1-1478991-0	17.8	411-3276
196A/U URM110	Solder/Clamp	Gold	Stainless Steel Passivated	Teflon	cs0	17.8	
RG174A/U	Solder/Clamp	Gold	Stainless Steel Gold	Teflon	1-1478990-0	17.8	411-3276
188A/U, 316/U URM95, KX3B KX22A	Solder/Clamp	Gold	Stainless Steel Passivated	Teflon	cs0	17.8	
RD316	Solder/Clamp	Gold	Stainless Steel Gold	Teflon	cs0	17.8	411-3276
	Solder/Clamp	Gold	Stainless Steel Passivated	Teflon	cs0	17.8	
RG55B/U, 142B/U 223/U, 400/U KX23	Solder/Clamp	Gold	Stainless Steel Gold	Teflon	1-1478992-0	26.9	411-3276
	Solder/Clamp	Gold	Stainless Steel Passivated	Teflon	cs0	26.9	
RG58C/U 141A/U URM43, 76 KX15	Solder/Clamp	Gold	Stainless Steel Gold	Teflon	1-1478989-0	26.9	411-3276
	Solder/Clamp	Gold	Stainless Steel Passivated	Teflon	cs0	26.9	

Preferred Part

**SMA Connectors 50 Ohm**

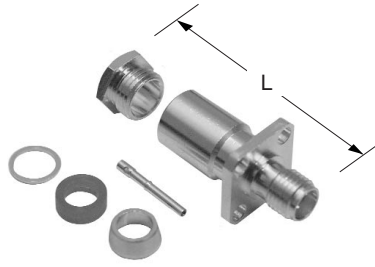

**SMA Panel Jacks 4-Hole Solder/Clamp 50 Ohm**

Connector Cable Range	Termination Type	Centre Contact Plating	Body Material & Finish	Dielectric	Part Number	L Dim.	Assembly Instruction
RG178B/U	Solder/Clamp	Gold	Stainless Steel Gold	Teflon	1-1478936-0	17.8	411-3276
196A/U URM110	Solder/Clamp	Gold	Stainless Steel Passivated	Teflon	2-1478936-0	17.8	
RG174A/U	Solder/Clamp	Gold	Stainless Steel Gold	Teflon	1-1478935-0	17.8	411-3276
188A/U, 316/U URM95, KX3B KX22A	Solder/Clamp	Gold	Stainless Steel Passivated	Teflon	2-1478935-0	17.8	
RD316	Solder/Clamp	Gold	Stainless Steel Gold	Teflon	cso	17.8	411-3276
	Solder/Clamp	Gold	Stainless Steel Passivated	Teflon	cso	17.8	
RG55B/U, 142B/U 223/U, 400/U KX23	Solder/Clamp	Gold	Stainless Steel Gold	Teflon	1-1478937-0	26.9	411-3276
	Solder/Clamp	Gold	Stainless Steel Passivated	Teflon	2-1478937-0	26.9	
RG58C/U 141A/U URM43, 76 KX15	Solder/Clamp	Gold	Stainless Steel Gold	Teflon	1-1478934-0	26.9	411-3276
	Solder/Clamp	Gold	Stainless Steel Passivated	Teflon	2-1478934-0	26.9	

Preferred Part

SMA Connectors 50 Ohm

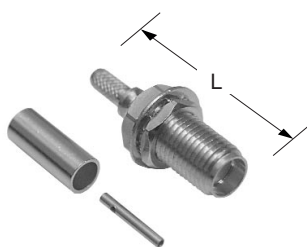

SMA Bulkhead Jacks Crimp 50 Ohm

Connector Cable Range	Termination Type	Centre Contact Plating	Body Material & Finish	Dielectric	Part Number	L Dim.	Interchangeable Die Hand Tool	Interchangeable Die Set	Assembly Instruction
RG174A/U 188A/U 316/U URM95 KX3B KX22A	Hex Crimp	Gold	Stainless Steel Gold	Teflon	1-1478955-0	22.6	9-1478240-0	9-1478248-0	411-3276
	Hex Crimp	Gold	Stainless Steel Passivated	Teflon	2-1478955-0	22.6	9-1478240-0	9-1478248-0	
	Hex Crimp	Gold	Brass, Gold	Teflon	3-1478955-0	22.6	9-1478240-0	9-1478248-0	
	Hex Crimp	Gold	Brass White Bronze	Teflon	4-1478955-0	22.6	9-1478240-0	9-1478248-0	
RD316	Hex Crimp	Gold	Stainless Steel Gold	Teflon	1-478957-0	22.6	9-1478240-0	9-1478248-0	411-3276
	Hex Crimp	Gold	Stainless Steel Passivated	Teflon	2-478957-0	22.6	9-1478240-0	9-1478248-0	
	Hex Crimp	Gold	Brass, Gold	Teflon	3-1478957-0	22.6	9-1478240-0	9-1478248-0	
	Hex Crimp	Gold	Brass White Bronze	Teflon	4-1478957-0	22.6	9-1478240-0	9-1478248-0	
RG55B/U 142B/U 223/U 400/U KX23	Hex Crimp	Gold	Stainless Steel Gold	Teflon	1-1478956-0	22.6	9-1478240-0	9-1478242-0	411-3276
	Hex Crimp	Gold	Stainless Steel Passivated	Teflon	2-1478956-0	22.6	9-1478240-0	9-1478242-0	
	Hex Crimp	Gold	Brass, Gold	Teflon	3-1478956-0	22.6	9-1478240-0	9-1478242-0	
	Hex Crimp	Gold	Brass White Bronze	Teflon	4-1478956-0	22.6	9-1478240-0	9-1478242-0	
RG58C/U 141A/U URM43, 76 KX15	Hex Crimp	Gold	Stainless Steel Gold	Teflon	1-1478954-0	22.6	9-1478240-0	9-1478242-0	411-3276
	Hex Crimp	Gold	Stainless Steel Passivated	Teflon	2-1478954-0	22.6	9-1478240-0	9-1478242-0	
	Hex Crimp	Gold	Brass, Gold	Teflon	3-1478954-0	22.6	9-1478240-0	9-1478242-0	
	Hex Crimp	Gold	Brass White Bronze	Teflon	4-1478954-0	22.6	9-1478240-0	9-1478242-0	

Preferred Part



**SMA Connectors 50 Ohm**

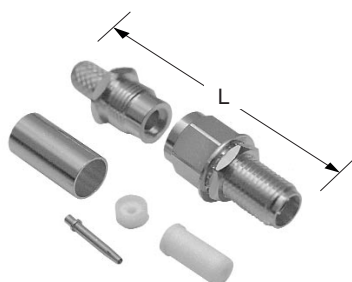

**SMA Bulkhead Jacks Mil-Crimp 50 Ohm**

Connector Cable Range	Termination Type	Centre Contact Plating	Body Material & Finish	Dielectric	Part Number	L Dim.	Interchangeable Die Hand Tool	Interchangeable Die Set	Assembly Instruction
RG178B/U 196A/U URM110	Hex Crimp	Gold	Stainless Steel Gold	Teflon	1-1478960-0	27.4	9-1478240-0	9-1478248-0	411-3276
	Hex Crimp	Gold	Stainless Steel Passivated	Teflon	2-1478960-0	27.4	9-1478240-0	9-1478248-0	
RG174A/U 188A/U, 316/U URM95, KX3B KX22A	Hex Crimp	Gold	Stainless Steel Gold	Teflon	1-1478959-0	27.4	9-1478240-0	9-1478248-0	411-3276
	Hex Crimp	Gold	Stainless Steel Passivated	Teflon	2-1478959-0	27.4	9-1478240-0	9-1478248-0	
RD316	Hex Crimp	Gold	Stainless Steel Gold	Teflon	cso	27.4	9-1478240-0	9-1478248-0	411-3276
	Hex Crimp	Gold	Stainless Steel Passivated	Teflon	cso	27.4	9-1478240-0	9-1478248-0	
RG55B/U, 142B/U 223/U, 400/U KX23	Hex Crimp	Gold	Stainless Steel Gold	Teflon	1-1478961-0	27.4	9-1478240-0	9-1478242-0	411-3276
	Hex Crimp	Gold	Stainless Steel Passivated	Teflon	2-1478961-0	27.4	9-1478240-0	9-1478242-0	
RG58C/U, 141A/U URM43, 76 KX15	Hex Crimp	Gold	Stainless Steel Gold	Teflon	1-1478958-0	27.4	9-1478240-0	9-1478242-0	411-3276
	Hex Crimp	Gold	Stainless Steel Passivated	Teflon	2-1478958-0	27.4	9-1478240-0	9-1478242-0	

Preferred Part

**SMA Connectors 50 Ohm**

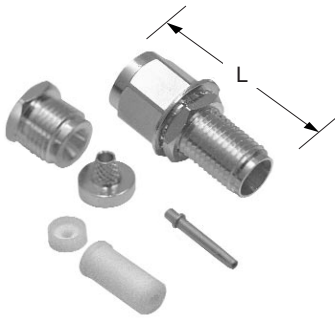

**SMA Bulkhead Jacks Solder/Clamp 50 Ohm**

Connector Cable Range	Termination Type	Centre Contact Plating	Body Material & Finish	Dielectric	Part Number	L Dim.	Assembly Instruction
RG178B/U 196A/U URM110	Solder/Clamp	Gold	Stainless Steel Gold	Teflon	1-1478940-0	21.6	411-3276
	Solder/Clamp	Gold	Stainless Steel Passivated	Teflon	2-1478940-0	21.6	
RG174A/U 188A/U, 316/U URM95, KX3B KX22A	Solder/Clamp	Gold	Stainless Steel Gold	Teflon	1-1478939-0	21.6	411-3276
	Solder/Clamp	Gold	Stainless Steel Passivated	Teflon	2-1478939-0	21.6	
RD316	Solder/Clamp	Gold	Stainless Steel Gold	Teflon	cso	21.6	411-3276
	Solder/Clamp	Gold	Stainless Steel Passivated	Teflon	cso	21.6	
RG55B/U, 142B/U 223/U, 400/U KX23	Solder/Clamp	Gold	Stainless Steel Gold	Teflon	1-1478941-0	26.9	411-3276
	Solder/Clamp	Gold	Stainless Steel Passivated	Teflon	2-1478941-0	26.9	
RG58C/U, 141A/U URM43, 76 KX15	Solder/Clamp	Gold	Stainless Steel Gold	Teflon	1-1478938-0	26.9	411-3276
	Solder/Clamp	Gold	Stainless Steel Passivated	Teflon	2-1478938-0	26.9	

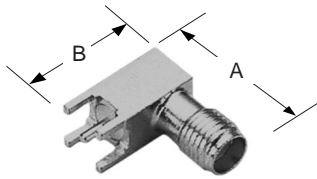

**SMA Elbow PCB Socket 50 Ohm**

Centre Contact Plating	Body Material & Finish	Dielectric	Part Number	A Dim.	B Dim.	Leg Length
Gold	Stainless Steel Gold	Teflon	1-1478978-0	15.6	13.5	3.40
Gold	Brass, Gold	Teflon	3-1478978-0	15.6	13.5	3.40
Gold	Brass, Gold	Delrin	3-1478978-1*	15.6	13.5	3.40

\* Bulk Pack 100 per Tray

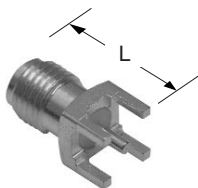

**SMA Straight PCB Socket 50 Ohm**

Centre Contact Plating	Body Material & Finish	Dielectric	Part Number	L Dim.	Leg Length
Gold	Stainless Steel Gold	Teflon	1-1478979-0	13.0	3.50
Gold	Brass, Gold	Teflon	3-1478979-0	13.0	3.50

Preferred Part 1-1478979-0

**SMA Connectors 50 Ohm**

**SMA Straight Adaptors Plug - Plug 50 Ohm**

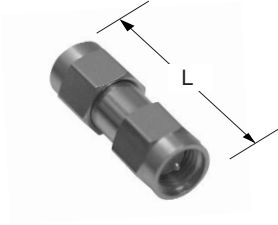

Centre Contact Plating	Body Material & Finish	Dielectric	L Dim.	Part Number
Gold	Stainless Steel Gold	Teflon	22.2	1-1478981-0
Gold	Stainless Steel Passivated	Teflon	22.2	2-1478981-0
Gold	Brass, Gold	Teflon	22.2	3-1478981-0
Gold	Brass White Bronze	Teflon	22.2	4-1478981-0

**SMA Straight Adaptors Jack - Jack 50 Ohm**

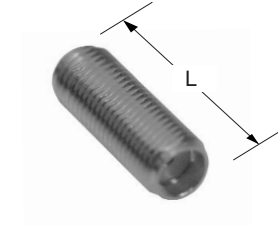

Centre Contact Plating	Body Material & Finish	Dielectric	L Dim.	Part Number
Gold	Stainless Steel Gold	Teflon	12.7	1-1478980-0
Gold	Stainless Steel Passivated	Teflon	12.7	2-1478980-0
Gold	Brass, Gold	Teflon	12.7	3-1478980-0
Gold	Brass White Bronze	Teflon	12.7	4-1478980-0

**SMA Straight Adaptors Plug - Jack 50 Ohm**

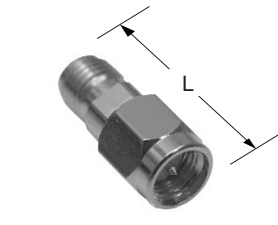

Centre Contact Plating	Body Material & Finish	Dielectric	L Dim.	Part Number
Gold	Stainless Steel Gold	Teflon	18.2	1-1478983-0
Gold	Stainless Steel Passivated	Teflon	18.2	2-1478983-0
Gold	Brass, Gold	Teflon	18.2	3-1478983-0
Gold	Brass White Bronze	Teflon	18.2	4-1478983-0

Preferred Part

**SMA Connectors 50 Ohm**

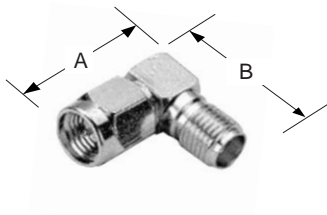

**SMA Elbow Adaptor Plug - Jack 50 Ohm**

Centre Contact Plating	Body Material & Finish	Dielectric	A Dim.	B Dim.	Part Number
Gold	Stainless Steel Gold	Teflon	16.5	15.0	1-1478982-0
Gold	Stainless Steel Passivated	Teflon	16.5	15.0	2-1478982-0
Gold	Brass, Gold	Teflon	16.5	15.0	3-1478982-0
Gold	Brass White Bronze	Teflon	16.5	15.0	4-1478982-0



**SMA Bulkhead Adaptor Jack - Jack 50 Ohm**

Centre Contact Plating	Body Material & Finish	Dielectric	L Dim.	W Dim.	Maximum Panel	Part Number
Gold	Stainless Steel Gold	Teflon	22.3	8.0 Hex	6.4	1-1478984-0
Gold	Stainless Steel Passivated	Teflon	22.3	8.0 Hex	6.4	2-1478984-0
Gold	Brass, Gold	Teflon	22.3	8.0 Hex	6.4	3-1478984-0
Gold	Brass White Bronze	Teflon	22.3	8.0 Hex	6.4	4-1478984-0

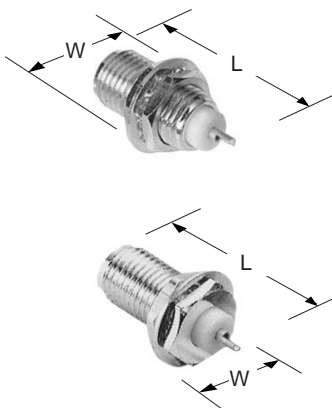

**SMA Bulkhead Sockets 50 Ohm**

Style	Centre Contact Plating	Body Material & Finish	Dielectric	L Dim.	W Dim.	Maximum Panel	Part Number
Front Mount	Gold	Stainless Steel Gold	Teflon	17.0	8.0 Hex	3.2	1-1478965-0
	Gold	Stainless Steel Passivated	Teflon	17.0	8.0 Hex	3.2	2-1478965-0
	Gold	Brass, Gold	Teflon	17.0	8.0 Hex	3.2	3-1478965-0
	Gold	Brass White Bronze	Teflon	17.0	8.0 Hex	3.2	4-1478965-0
Rear Mount	Gold	Stainless Steel Gold	Teflon	17.0	8.0 Hex	3.2	1-1478966-0
	Gold	Stainless Steel Passivated	Teflon	17.0	8.0 Hex	3.2	2-1478966-0
	Gold	Brass, Gold	Teflon	17.0	8.0 Hex	3.2	3-1478966-0
	Gold	Brass White Bronze	Teflon	17.0	8.0 Hex	3.2	4-1478966-0

Preferred Part

**SMA Connectors 50 Ohm**

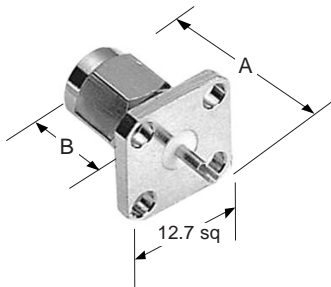

**SMA Panel Plug 4-Hole 50 Ohm**

Centre Contact Plating	Body Material & Finish	Dielectric	A Dim.	B Dim.	Part Number
Gold	Stainless Steel Gold	Teflon	15.4	11.2	1-1478993-0
Gold	Stainless Steel Passivated	Teflon	15.4	11.2	2-1478993-0

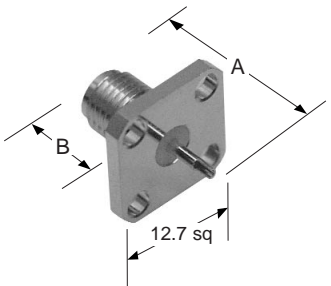

**SMA Panel Socket 4-Hole 50 Ohm**

Centre Contact Plating	Body Material & Finish	Dielectric	A Dim.	B Dim.	Part Number
Gold	Stainless Steel Gold	Teflon	14.4	9.5	1-1478962-0
Gold	Stainless Steel Passivated	Teflon	14.4	9.5	2-1478962-0
Gold	Brass, Gold	Teflon	14.4	9.5	3-1478962-0
Gold	Brass White Bronze	Teflon	14.4	9.5	4-1478962-0

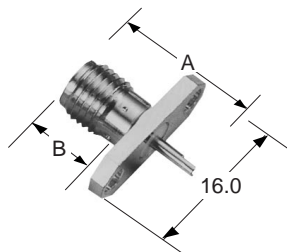

**SMA Panel Socket 2-Hole 50 Ohm**

Centre Contact Plating	Body Material & Finish	Dielectric	A Dim.	B Dim.	Part Number
Gold	Stainless Steel Gold	Teflon	14.4	9.5	1-1478963-0
Gold	Stainless Steel Passivated	Teflon	14.4	9.5	2-1478963-0
Gold	Brass, Gold	Teflon	14.4	9.5	3-1478963-0
Gold	Brass White Bronze	Teflon	14.4	9.5	4-1478963-0

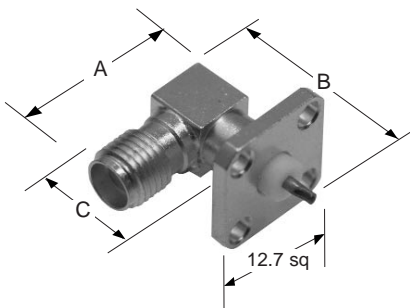

**SMA Elbow Panel Socket 4-Hole 50 Ohm**

Centre Contact Plating	Body Material & Finish	Dielectric	A Dim.	B Dim.	C Dim.	Part Number
Gold	Stainless Steel Gold	Teflon	15.0	17.3	12.8	1-1478964-0
Gold	Stainless Steel Passivated	Teflon	15.0	17.3	12.8	2-1478964-0

Preferred Part

**SMA Connectors 50 Ohm**

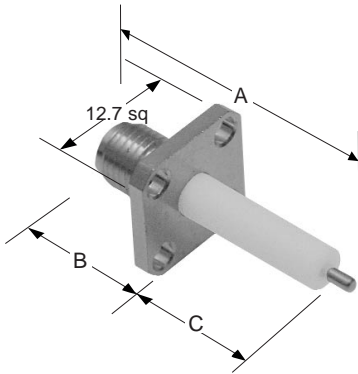

**SMA Panel Socket Launcher 4-Hole 50 Ohm**

Centre Contact Plating	Body Material & Finish	Contact Captivation	Dielectric	A Dim.	B Dim.	C Dim.	Part Number
Gold	Stainless Steel Gold	Mechanical	Teflon	27.4	9.5	15.0	1-1478967-0
Gold	Stainless Steel Passivated	Mechanical	Teflon	27.4	9.5	15.0	2-1478967-0
Gold	Brass, Gold	Mechanical	Teflon	27.4	9.5	15.0	3-1478967-0
Gold	Brass White Bronze	Mechanical	Teflon	27.4	9.5	15.0	4-1478967-0
Gold	Stainless Steel Gold	None	Teflon	27.4	9.5	15.0	1-1478968-0
Gold	Stainless Steel Passivated	None	Teflon	27.4	9.5	15.0	2-1478968-0
Gold	Brass, Gold	None	Teflon	27.4	9.5	15.0	3-1478968-0
Gold	Brass White Bronze	None	Teflon	27.4	9.5	15.0	4-1478968-0

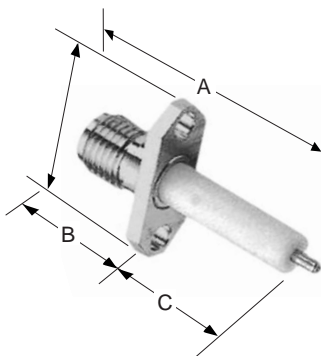

**SMA Panel Socket Launcher 2-Hole 50 Ohm**

Centre Contact Plating	Body Material & Finish	Contact Captivation	Dielectric	A Dim.	B Dim.	C Dim.	Part Number
Gold	Stainless Steel Gold	Mechanical	Teflon	27.4	9.5	15.0	1-1478969-0
Gold	Stainless Steel Passivated	Mechanical	Teflon	27.4	9.5	15.0	2-1478969-0
Gold	Brass, Gold	Mechanical	Teflon	27.4	9.5	15.0	3-1478969-0
Gold	Brass White Bronze	Mechanical	Teflon	27.4	9.5	15.0	4-1478969-0
Gold	Stainless Steel Gold	None	Teflon	27.4	9.5	15.0	1-1478970-0
Gold	Stainless Steel Passivated	None	Teflon	27.4	9.5	15.0	2-1478970-0
Gold	Brass, Gold	None	Teflon	27.4	9.5	15.0	3-1478970-0
Gold	Brass White Bronze	None	Teflon	27.4	9.5	15.0	4-1478970-0

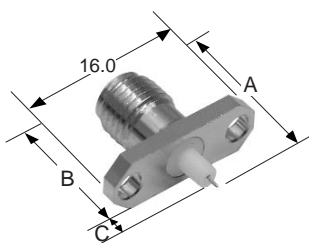

**SMA Panel Socket Launcher 2-Hole Microstrip 50 Ohm**

Centre Contact Plating	Body Material & Finish	Dielectric	A Dim.	B Dim.	C Dim.	Part Number
Gold	Stainless Steel Gold	Teflon	14.0	9.5	3.2	1-1478977-0
Gold	Stainless Steel Passivated	Teflon	14.0	9.5	3.2	2-1478977-0
Gold	Brass, Gold	Teflon	14.0	9.5	3.2	3-1478977-0
Gold	Brass White Bronze	Teflon	14.0	9.5	3.2	4-1478977-0

Preferred Part

**SMA Connectors 50 Ohm**

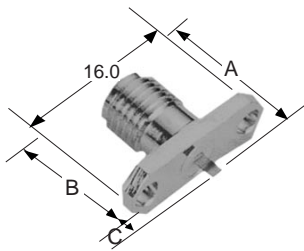

**SMA Panel Socket Launcher 2-Hole Tab Contact 50 Ohm**

Centre Contact Plating	Body Material & Finish	Dielectric	A Dim.	B Dim.	C Dim.	Part Number
Gold	Stainless Steel Gold	Teflon	12.0	9.5	2.5	1-1478972-0
Gold	Stainless Steel Passivated	Teflon	12.0	9.5	2.5	2-1478972-0
Gold	Brass, Gold	Teflon	12.0	9.5	2.5	3-1478972-0
Gold	Brass White Bronze	Teflon	12.0	9.5	2.5	4-1478972-0

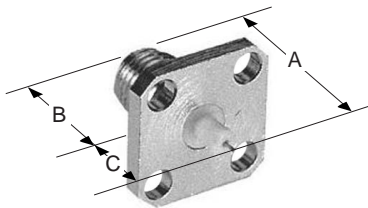

**SMA Panel Socket Launcher 4-Hole Stub Contact 50 Ohm**

Centre Contact Plating	Body Material & Finish	Dielectric	A Dim.	B Dim.	C Dim.	Part Number
Gold	Stainless Steel Gold	Teflon	14.0	9.5	3.2	1-1478976-0
Gold	Stainless Steel Passivated	Teflon	14.0	9.5	3.2	2-1478976-0
Gold	Brass, Gold	Teflon	14.0	9.5	3.2	3-1478976-0
Gold	Brass White Bronze	Teflon	14.0	9.5	3.2	4-1478976-0

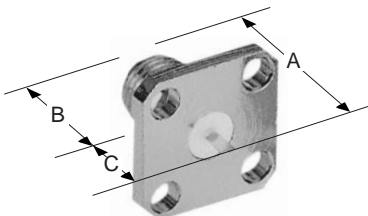

**SMA Panel Socket Launcher 4-Hole Tab Contact 50 Ohm**

Centre Contact Plating	Body Material & Finish	Dielectric	A Dim.	B Dim.	C Dim.	Part Number
Gold	Stainless Steel Gold	Teflon	T.B.A	T.B.A	T.B.A	1-1478971-0
Gold	Stainless Steel Passivated	Teflon	T.B.A	T.B.A	T.B.A	2-1478971-0
Gold	Brass, Gold	Teflon	T.B.A	T.B.A	T.B.A	3-1478971-0
Gold	Brass White Bronze	Teflon	T.B.A	T.B.A	T.B.A	4-1478971-0

Preferred Part

**SMA Connectors 50 Ohm**

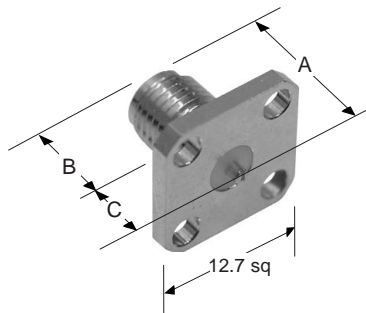

**SMA Panel Socket Launcher 4-Hole Slotted Contact 50 Ohm**

Centre Contact Plating	Body Material & Finish	Dielectric	A Dim.	B Dim.	C Dim.	Slot Width	Part Number
Gold	Stainless Steel Gold	Teflon	10.8	9.5	1.3	0.3	1-1478973-0
Gold	Stainless Steel Passivated	Teflon	10.8	9.5	1.3	0.3	2-1478973-0
Gold	Brass, Gold	Teflon	10.8	9.5	1.3	0.3	3-1478973-0
Gold	Brass White Bronze	Teflon	10.8	9.5	1.3	0.3	4-1478973-0
Gold	Stainless Steel Gold	Teflon	10.8	9.5	1.3	0.5	1-1478974-0
Gold	Stainless Steel Passivated	Teflon	10.8	9.5	1.3	0.5	2-1478974-0
Gold	Brass, Gold	Teflon	10.8	9.5	1.3	0.5	3-1478974-0
Gold	Brass White Bronze	Teflon	10.8	9.5	1.3	0.5	4-1478974-0
Gold	Stainless Steel Gold	Teflon	10.8	9.5	1.3	0.7	1-1478975-0
Gold	Stainless Steel Passivated	Teflon	10.8	9.5	1.3	0.7	2-1478975-0
Gold	Brass, Gold	Teflon	10.8	9.5	1.3	0.7	3-1478975-0
Gold	Brass White Bronze	Teflon	10.8	9.5	1.3	0.7	4-1478975-0

**SMA Plug Dust Cap & Chain**

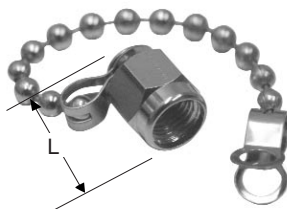

Body Material & Finish	L Dim.	Part Number
Brass, Gold	11.7	3-1478985-0

**SMA Jack Dust Cap & Chain**

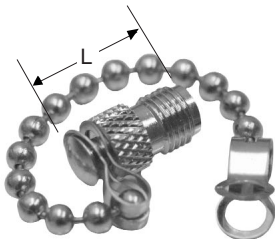

Body Material & Finish	L Dim.	Part Number
Brass, Gold	13.7	3-1478986-0

Preferred Part



**SMA Connectors 50 Ohm**

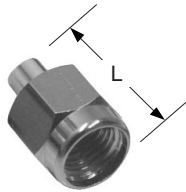

**SMA Plug Termination, 1 Watt, 50 Ohm**

Style	Centre Contact Plating	Body Material & Finish	Dielectric	L Dim.	Part Number
Plug	Gold	Brass, Gold	Teflon	17.7	CS0

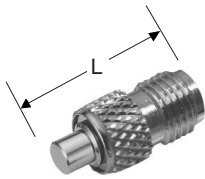

**SMA Jack Termination, 1 Watt, 50 Ohm**

Style	Centre Contact Plating	Body Material & Finish	Dielectric	L Dim.	Part Number
Plug	Gold	Brass, Gold	Teflon	17.7	CS0



**SMA Die Sets**

Cable Type	Interchangable Die Set Number	Cavity Size
RG178B/U 196A/U URM110	9-1478248-0	2.8
RG174B/U, 188A/U 316/U, URM95 KX3B, KX22A	9-1478248-0	3.4
RD316	9-1478248-0	3.4
RG55B/U, 142A/U 223/U 440/U, KX23	9-1478242-0	5.6
RG58C/U, 141A/U URM43, 76 KX15	9-1478242-0	5.6



**SMA Hand Tool**

Part Number
9-1478240-0

Preferred Part

SMA Adaptors



SMA Plug to BNC Plug

Centre Contact Plating	Body Plating	Dielectric	Part Number
Gold	Nickel	Teflon	1-1478217-0

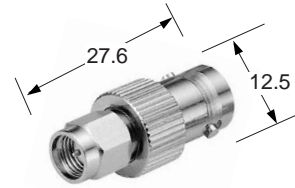

SMA Plug to BNC Jack

Centre Contact Plating	Body Plating	Dielectric	Part Number
Gold	Nickel	Teflon	1-1337576-0

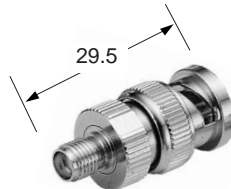

SMA Jack to BNC Plug

Centre Contact Plating	Body Plating	Dielectric	Part Number
Gold	Nickel	Teflon	1-1478216-0

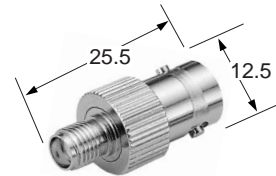

SMA Jack to BNC Jack

Centre Contact Plating	Body Plating	Dielectric	Part Number
Gold	Nickel	Teflon	1-1337577-0

Preferred Part

SMA Adaptors

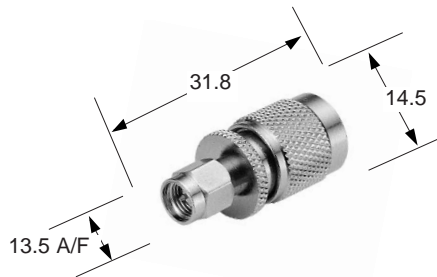

**SMA Plug to TNC Plug**

Centre Contact Plating	Body Plating	Dielectric	Part Number
Gold	Gold	Teflon	CSO
Gold	Nickel	Teflon	CSO

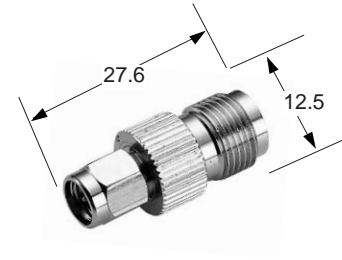

**SMA Plug to TNC Jack**

Centre Contact Plating	Body Plating	Dielectric	Part Number
Gold	Gold	Teflon	CSO
Gold	Nickel	Teflon	CSO



**SMA Jack to TNC Plug**

Centre Contact Plating	Body Plating	Dielectric	Part Number
Gold	Gold	Teflon	CSO
Gold	Nickel	Teflon	CSO

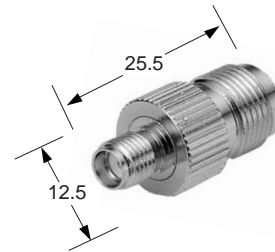

**SMA Jack to TNC Jack**

Centre Contact Plating	Body Plating	Dielectric	Part Number
Gold	Gold	Teflon	CSO
Gold	Nickel	Teflon	CSO

Preferred Part

SMA Adaptors

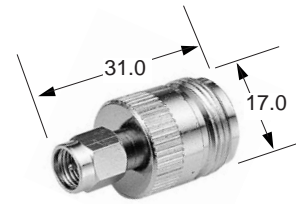
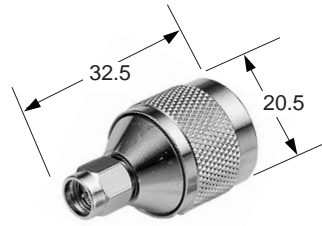

SMA Plug to N Plug

Centre Contact Plating	Body Plating	Dielectric	Part Number
Gold	Gold	Teflon	cs0
Gold	Nickel	Teflon	1-1337575-0

SMA Plug to N Jack

Centre Contact Plating	Body Plating	Dielectric	Part Number
Gold	Gold	Teflon	cs0
Gold	Nickel	Teflon	1-1337568-0

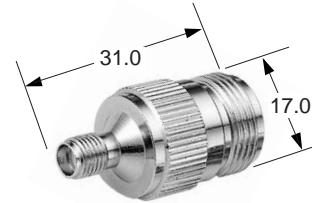
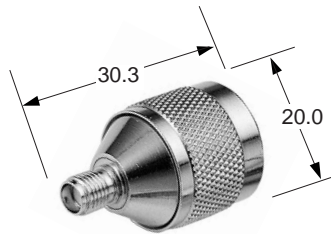

SMA Jack to N Plug

Centre Contact Plating	Body Plating	Dielectric	Part Number
Gold	Gold	Teflon	cs0
Gold	Nickel	Teflon	1-1337566-0

SMA Jack to N Jack

Centre Contact Plating	Body Plating	Dielectric	Part Number
Gold	Gold	Teflon	cs0
Gold	Nickel	Teflon	1-1337578-0

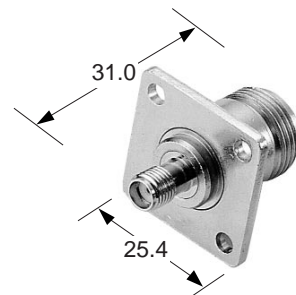
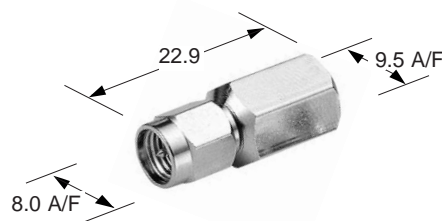

FME Jack to SMA Plug

Centre Contact Plating	Body Plating	Dielectric	Part Number
Gold	Gold	Teflon	1-1337558-0

Panel Mount SMA Jack to N Jack

Centre Contact Plating	Body Plating	Dielectric	Part Number
Gold	Gold	Teflon	cs0
Gold	Nickel	Teflon	cs0

Preferred Part

**Part Number Index**

Part Number	Page Number
1-1337558-0	28
1-1337566-0	28
1-1337568-0	28
1-1337575-0	28
1-1337576-0	26
1-1337577-0	26
1-1337578-0	28
1-1478216-0	26
1-1478217-0	26
1-1478902-0	5
1-1478903-0	5
1-1478904-0	5
1-1478905-0	5
1-1478906-0	5
1-1478907-0	8
1-1478908-0	8
1-1478909-0	8
1-1478910-0	8
1-1478911-0	10
1-1478912-0	10
1-1478913-0	10
1-1478914-0	10
1-1478915-0	7
1-1478916-0	7
1-1478917-0	7
1-1478918-0	7
1-1478921-0	8
1-1478922-0	8
1-1478923-0	9
1-1478924-0	9
1-1478925-0	9
1-1478926-0	9
1-1478928-0	6
1-1478929-0	6
1-1478930-0	6
1-1478931-0	6
1-1478932-0	6
1-1478933-0	6
1-1478934-0	15
1-1478935-0	15
1-1478936-0	15
1-1478937-0	15
1-1478938-0	18
1-1478939-0	18
1-1478940-0	18
1-1478941-0	18
1-1478942-0	11
1-1478943-0	11
1-1478944-0	11
1-1478946-0	12
1-1478947-0	12
1-1478948-0	12
1-1478949-0	12
1-1478950-0	13
1-1478951-0	13
1-1478952-0	13
1-1478953-0	13
1-1478954-0	16
1-1478955-0	16
1-1478956-0	16
1-1478957-0	16
1-1478958-0	17
1-1478959-0	17
1-1478960-0	17
1-1478961-0	17

Part Number	Page Number
1-1478962-0	21
1-1478963-0	21
1-1478964-0	21
1-1478965-0	20
1-1478966-0	20
1-1478967-0	22
1-1478968-0	22
1-1478969-0	22
1-1478970-0	22
1-1478971-0	23
1-1478972-0	23
1-1478973-0	24
1-1478974-0	24
1-1478975-0	24
1-1478976-0	23
1-1478977-0	22
1-1478978-0	18
1-1478979-0	18
1-1478980-0	19
1-1478981-0	19
1-1478982-0	20
1-1478983-0	19
1-1478984-0	20
1-1478987-0	6
1-1478988-0	6
1-1478989-0	14
1-1478990-0	14
1-1478991-0	14
1-1478992-0	14
1-1478993-0	21
2-1478902-0	5
2-1478903-0	5
2-1478904-0	5
2-1478905-0	5
2-1478906-0	5
2-1478907-0	8
2-1478908-0	8
2-1478909-0	8
2-1478910-0	8
2-1478911-0	10
2-1478912-0	10
2-1478913-0	10
2-1478914-0	10
2-1478915-0	7
2-1478916-0	7
2-1478917-0	7
2-1478918-0	7
2-1478921-0	8
2-1478922-0	8
2-1478923-0	9
2-1478924-0	9
2-1478925-0	9
2-1478926-0	9
2-1478934-0	15
2-1478935-0	15
2-1478936-0	15
2-1478937-0	15
2-1478938-0	18
2-1478939-0	18
2-1478940-0	18
2-1478941-0	18
2-1478942-0	11
2-1478943-0	11
2-1478944-0	11
2-1478946-0	12

Part Number	Page Number
2-1478947-0	12
2-1478948-0	12
2-1478949-0	12
2-1478950-0	13
2-1478951-0	13
2-1478952-0	13
2-1478953-0	13
2-1478954-0	16
2-1478955-0	16
2-1478956-0	16
2-1478957-0	16
2-1478958-0	17
2-1478959-0	17
2-1478960-0	17
2-1478961-0	17
2-1478962-0	21
2-1478963-0	21
2-1478964-0	21
2-1478965-0	20
2-1478966-0	20
2-1478967-0	22
2-1478968-0	22
2-1478969-0	22
2-1478970-0	22
2-1478971-0	23
2-1478972-0	23
2-1478973-0	24
2-1478974-0	24
2-1478975-0	24
2-1478976-0	23
2-1478977-0	22
2-1478980-0	19
2-1478981-0	19
2-1478982-0	20
2-1478983-0	19
2-1478984-0	20
2-1478989-0	21
3-1478903-0	5
3-1478904-0	5
3-1478905-0	5
3-1478906-0	5
3-1478915-0	7
3-1478916-0	7
3-1478917-0	7
3-1478918-0	7
3-1478923-0	9
3-1478924-0	9
3-1478925-0	9
3-1478926-0	9
3-1478927-0	9
3-1478928-0	6
3-1478929-0	6
3-1478942-0	11
3-1478943-0	11
3-1478944-0	11
3-1478945-0	11
3-1478954-0	16
3-1478955-0	16
3-1478956-0	16
3-1478957-0	16
3-1478962-0	21
3-1478963-0	21
3-1478965-0	20
3-1478966-0	20
3-1478967-0	22

Part Number	Page Number
3-1478968-0	22
3-1478969-0	22
3-1478970-0	22
3-1478971-0	23
3-1478972-0	23
3-1478973-0	24
3-1478974-0	24
3-1478975-0	24
3-1478976-0	23
3-1478977-0	22
3-1478978-0	18
3-1478978-1	18
3-1478979-0	18
3-1478980-0	19
3-1478981-0	19
3-1478982-0	20
3-1478983-0	19
3-1478984-0	20
3-1478985-0	24
3-1478986-0	24
3-1478987-0	6
3-1478988-0	6
4-1478915-0	7
4-1478916-0	7
4-1478917-0	7
4-1478918-0	7
4-1478923-0	9
4-1478924-0	9
4-1478925-0	9
4-1478926-0	9
4-1478927-0	9
4-1478942-0	11
4-1478943-0	11
4-1478944-0	11
4-1478945-0	11
4-1478954-0	16
4-1478955-0	16
4-1478956-0	16
4-1478957-0	16
4-1478962-0	21
4-1478963-0	21
4-1478965-0	20
4-1478966-0	20
4-1478967-0	22
4-1478968-0	22
4-1478969-0	22
4-1478970-0	22
4-1478971-0	23
4-1478972-0	23
4-1478973-0	24
4-1478974-0	24
4-1478975-0	24
4-1478976-0	23
4-1478977-0	22
4-1478981-0	19
4-1478982-0	20
4-1478983-0	19
4-1478984-0	20
4-1478989-0	21
9-1478240-0	25
9-1478242-0	25
9-1478248-0	25

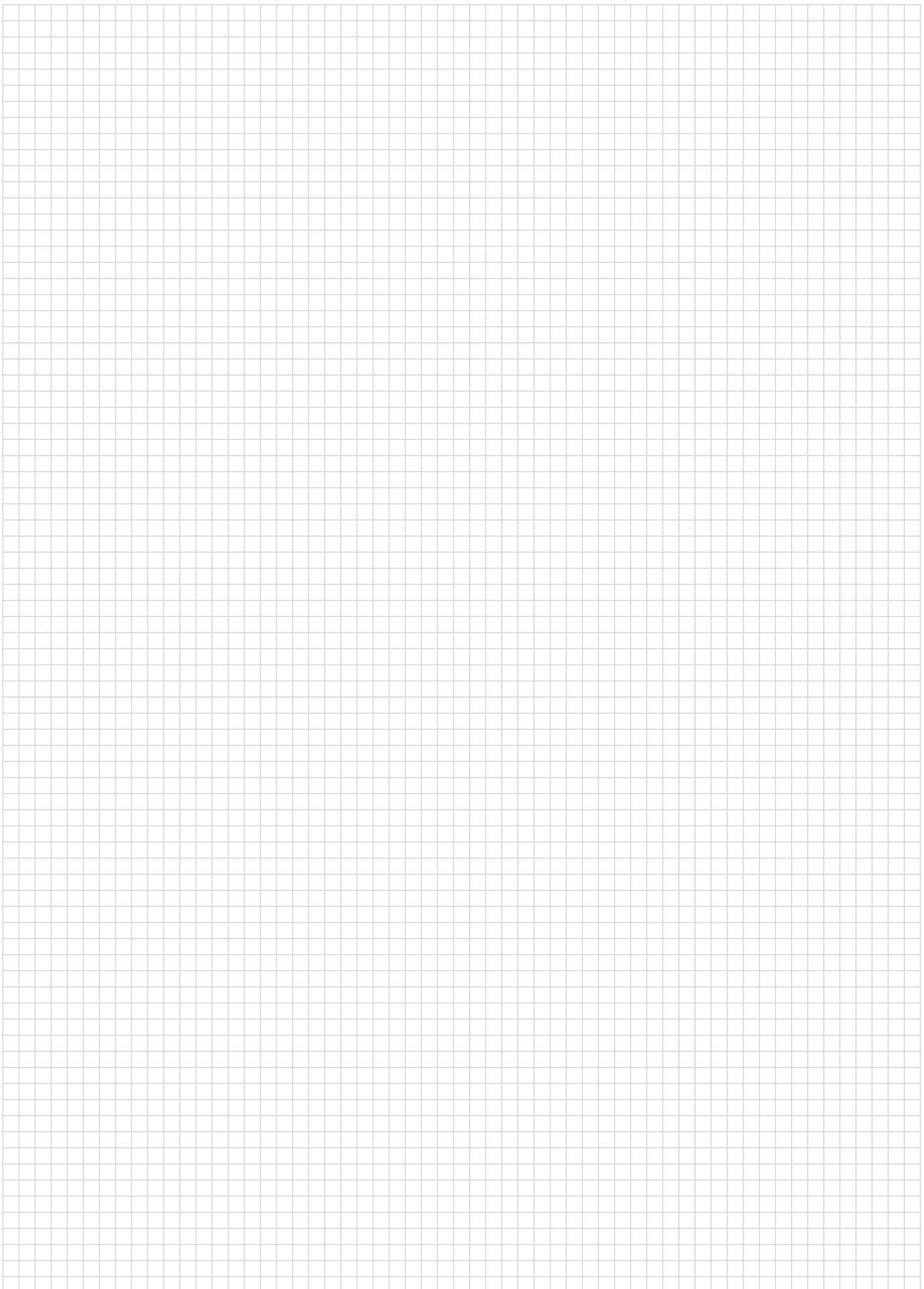



**Americas**

**Argentina** - Buenos Aires  
Phone: +54-1-733-2000  
Fax: +54-1-717-0988

**Brazil** - São Paulo  
Phone: +55-11-3611-1311  
Fax: +55-11-3611-0397

**Canada** - Toronto  
Phone: +905-475-6222  
Fax: +905-474-5520

**Chile** - Santiago  
Phone: +56-2-739-1230  
Fax: +56-2-739-1227

**Columbia** - Bogota  
Phone: +57-1-231-9398  
Fax: +57-1-240-3769

**Mexico** - Mexico City  
Phone: +52-5-729-0400  
Fax: +52-5-361-8545

**United States** - Harrisburg, PA  
Phone: +1-717-564-0100  
Fax: +1-717-986-7575

**Customer Service:**  
Phone: +1-800-522-6752

**Venezuela** - Caracas  
Phone: +58-2-986-7774  
Fax: +58-2-986-9739

**For Latin/South American Countries not shown**  
Phone: +54-11-4733-2015  
Fax: +54-11-4733-2083

**Asia/Pacific**

**Australia** - Sydney  
Phone: +61-2-9554-2600  
Fax: +61-2-9502-2556

**India** - Bangalore  
Phone: +91-80-841-0200  
Fax: +91-80-841-0210

**Indonesia** - Jakarta  
Phone: +62-21-526-7852  
Fax: +62-21-526-7856

**Japan** - Kawasaki, Kanagawa  
Phone: +81-44-844-8111  
Fax: +81-44-812-3207

**Korea** - Seoul  
Phone: +82-2-3415-4500  
Fax: +82-2-3486-3810

**Malaysia** - Selangor  
Phone: +60-3-7805-3055  
Fax: +60-3-7805-3066

**New Zealand** - Auckland  
Phone: +64-9-634-4580  
Fax: +64-9-634-4586

**Philippines** - Makati City  
Phone: +632-867-8641  
Fax: +632-867-8661

**People's Republic of China**  
Hong Kong  
Phone: +852-2735-1628  
Fax: +852-2735-0243

Shanghai  
Phone: +86-21-5383-8188  
Fax: +86-21-5383-8018

Shunde  
Phone: +86-765-775-1368  
Fax: +86-765-775-2823

**Singapore** - Singapore  
Phone: +65-480-4525  
Fax: +65-482-1012

**Taiwan** - Taipei  
Phone: +886-2-2664-9977  
Fax: +886-2-2664-9900

**Thailand** - Bangkok  
Phone: +66-2-955-0500  
Fax: +66-2-955-0505

**Vietnam** - Ho Chi Minh City  
Phone: +84-8-930-4547  
Fax: +84-8-930-3443

**Europe/Middle East/Africa**

**Austria** - Vienna  
Phone: +43-1-90-560-0  
Fax: +43-1-90-560-1333

**Belgium** - Kessel-Lo  
Phone: +32-16-352-300  
Fax: +32-16-352-352

**Bulgaria** - Sofia  
Phone: +359-2-971-2152  
Fax: +359-2-971-2153

**Czech Republic** - Kurim  
Phone: +420-5-41-162-111  
Fax: +420-5-41-162-223

**Denmark** - Viby J  
Phone: +45-70-15-52-00  
Fax: +45-86-29-51-33

**Egypt** - Cairo  
Phone: +20-2-417-76-47  
Fax: +20-2-419-23-34

**Estonia** - Tallinn  
Phone: +372-65-05-474  
Fax: +372-65-05-470

**Finland** - Helsinki  
Phone: +358-95-12-34-20  
Fax: +358-95-12-34-250

**France** - Cergy-Pontoise Cedex  
Phone: +33-1-3420-8888  
Fax: +33-1-3420-8600

**Product Information Centre:**  
Phone: +33-1-3420-8943  
Fax: +33-1-3420-8623

**Tyco Electronics Export** - Cergy-Pontoise Cedex  
Phone: +33-1-3420-2401  
Fax: +33-1-3420-2424

**Germany** - Bensheim  
Phone: +49-6251-133-0  
Fax: +49-6251-133-1600

**Product Information Centre:**  
Phone: +49-6251-133-1999  
Fax: +49-6251-133-1988

**Great Britain** - Stanmore, Middlesex  
Phone: +44-208-954-2356  
Fax: +44-208-954-6234

**Product Information Centre:**  
Freephone GB: 0800-267-666  
Phone: +44-208-420-8343  
Fax: +44-208-420-8345

**Greece** - Athens  
Phone: +30-1-9370-396/397  
Fax: +30-1-9370-655

**Hungary** - Budapest  
Phone: +36-1-289-1000  
Fax: +36-1-289-1010

**Ireland** - Dublin  
Phone: +353-1-820-3000  
Fax: +353-1-820-9790

**Israel** - Yokneam  
Phone: +972-4-959-0508  
Fax: +972-4-959-0506

**Italy** - Collegno (Torino)  
Phone: +39-011-4012-111  
Fax: +39-011-4031-116

**Lithuania** - Vilnius  
Phone: +370-5-2131-402  
Fax: +370-5-2131-403

**Netherlands** - 's-Hertogenbosch  
Phone: +31-73-6246-246  
Fax: +31-73-6212-365

**Product Information Centre:**  
Phone: +31-73-6246-999  
Fax: +31-73-6246-998

**Norway** - Nesbru  
Phone: +47-66-77-88-99  
Fax: +47-66-77-88-55

**Poland** - Warsaw  
Phone: +48-22-45-76-700  
Fax: +48-22-45-76-720

**Romania** - Bucharest  
Phone: +40-21-311-3479+3596  
Fax: +40-21-312-0574

**Russia** - Moscow  
Phone: +7-095-926-55-06...09  
Fax: +7-095-926-55-05

**Russia** - St. Petersburg  
Phone: +7-812-118-8192  
Fax: +7-812-118-8193

**Slovenia** - Ljubljana  
Phone: +386-1561-3270  
Fax: +386-1561-3240

**South Africa** - Port Elizabeth  
Phone: +27-41-405-4500  
Fax: +27-41-486-1314

**Spain** - Barcelona  
Phone: +34-93-291-0330  
Fax: +34-93-201-7879

**Product Information Centre:**  
Phone: +34-93-291-0330  
Fax: +34-93-200-3779

**Sweden** - Upplands Väsby  
Phone: +46-8-50-72-50-00  
Fax: +46-8-50-72-50-01

**Switzerland** - Steinach  
Phone: +41-71-447-0447  
Fax: +41-71-447-0444

**Turkey** - Istanbul  
Phone: +90-212-281-8181...3  
+90-212-282-5130/5430  
Fax: +90-212-281-8184

**Ukraine** - Kiev  
Phone: +38-044-238-6908  
Fax: +38-044-568-5740