

Industrial GNSS dead-reckoning module with 6-axis IMU



Features

- Simultaneous multiconstellation
- Teseo dead-reckoning Automotive way firmware
- -163 dBm sensitivity tracking
- 1.5 m CEP accuracy positioning
- Embedded Flash for FW upgrade
- GNSS and 6-axis inertial sensor
- 3.3 V supply voltage
- LCC 24 pins package (16.0 mm x 12.2 mm x 2.42 mm)
- Operating temperature (from -40 °C to +85 °C)
- Free FW configuration
- 17 µA standby current

Description

Teseo-VIC3D module is an easy to use dead-reckoning Global Navigation Satellite System (GNSS) standalone module, embedding TeseoIII single die standalone positioning receiver IC working simultaneously on multiple constellations (GPS/Galileo/Glonass/BeiDou/QZSS).

The Teseo-VIC3D module brings the proven accuracy and robustness of TeseoIII chip to the reach of everyone: the embedded firmware and the complete evaluation environment save development time.

Within its 16.0mm x 12.2mm size, Teseo-VIC3D is offering superior accuracy thanks to the on board Temperature Compensated Crystal Oscillator (TCXO) and a reduced Time To First Fix (TTFF) relying to its dedicated Real Time Clock (RTC) oscillator. Thanks to the embedded flash Teseo-VIC3D offers many extra features such, 7 days Autonomous Assisted GNSS and Real-Time Assisted GNSS.

Teseo-VIC3D supports FW configurability as well as FW upgrades. Teseo-VIC3D module, being a certified solution, optimizes the time to market of the final applications with a temperature operating range from -40 °C to +85 °C.

Product status link

[Teseo-VIC3D](#)

Product summary

Device Type	Teseo-VIC3D
Order code	Teseo-DRAW
Device grade	Industrial grade

1 Overview

1.1 GNSS performance

Receiver specification

- GPS L1C/A
- SBAS L1C/A
- QZSS L1C/A
- GLONASS L1OF
- BeiDou B1I
- Galileo E1

Table 1. GNSS performance

Parameter	Specification	GPS and GLONASS	GPS and BeiDou	GPS and Galileo	Unit
Time To First Fix ⁽¹⁾	Cold start	< 32	< 36	< 30	s
	Warm start	< 25	< 29	< 26	
	Hot start	< 1.5	< 2.5	< 2	
Sensitivity ⁽²⁾⁽³⁾	Tracking	-163	-163	-163	dBm
	Navigation ⁽⁴⁾	-158	-158	-158	
	Reacquisition ⁽⁵⁾⁽⁶⁾	-156	-156	-156	
	Cold start	-147	-147	-147	
	Warm start	-148	-148	-148	
	Hot start	-154	-151	-154	
Max DR fix rate	-	30	30	30	Hz
Velocity accuracy(50% at 30 m/s - linear path)	-	0.01	-	0.01	m/s
Velocity accuracy(50% at 0.5 g - shape path)	-	0.1	-	0.1	m/s
Heading accuracy(50% at 30 m/s - linear path)	-	0.01	-	0.01	°
Heading accuracy(50% at 0.5 g - shape path)	-	2.3	-	2.4	°
Horizontal position accuracy ⁽⁷⁾	Autonomous	< 1.5	< 1.5	-	m
	SBAS	< 1.4	-	-	
Accuracy of time pulse	99%	±19.6	±29.09	±21.8	
Frequency of time pulse	1	1	1	1	Hz
Operational limits ⁽⁸⁾	Dynamic ⁽⁹⁾	< 4.5g	< 4g	< 4.5g	
	Altitude	18000	18000	18000	m
	Velocity	515	515	515	m/s
Operational ITAR limits ⁽¹⁰⁾	Altitude	18000	18000	18000	m
	Velocity	515	515	515	m/s

1. All satellites at -130 dBm - TTFF at 50%

2. For hot start, all sats have the same signal level except one (pilot sat at -145 dBm)

3. For BEIDOU tracking sensitivity refers to MEO sats. For GEO the tracking sensitivity is -151 dBm
4. Configurable value.
5. All satellites at same signal level.
6. Minimum level to get valid fix after reacquisition.
7. CEP 50%, 24h static, roof antenna.
8. Verified the limit checking the fix availability
9. Special configuration for high dynamic scenario
10. To be compliant with USA International Traffic in Arms Regulations (ITAR), when both the ITAR altitude limit and the ITAR velocity limit are overpass taken the Teseo-VIC3D stops providing NMEA stream.

1.2 Block diagram

Figure 1. Block schematic

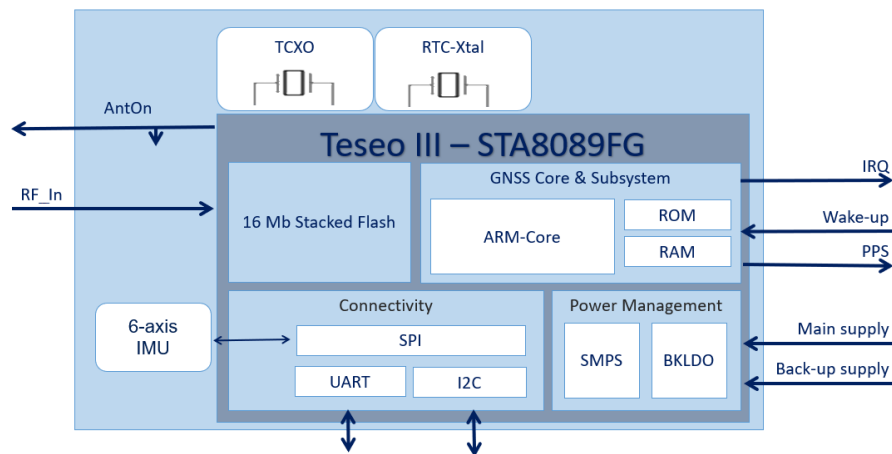

1.3 Pin configuration

Figure 2. Teseo-VIC3D pins layout

13	GND		GND	12
14	AntOFF		RF_IN	11
15	FWD		GND	10
16	Reserved		VCC_RF	9
17	Reserved		nReset	8
18	I2C_SDA	Teseo-VIC3	Reserved	7
19	I2C_SCL		IRQ	6
20	UART-TX		Reserved	5
21	UART-RX		WHELTICK	4
22	V_BAT		PPS	3
23	VCC		Reserved	2
24	GND		WakeUp	1

1.4 Pin out description

Figure 3. Direction of the detectable accelerations

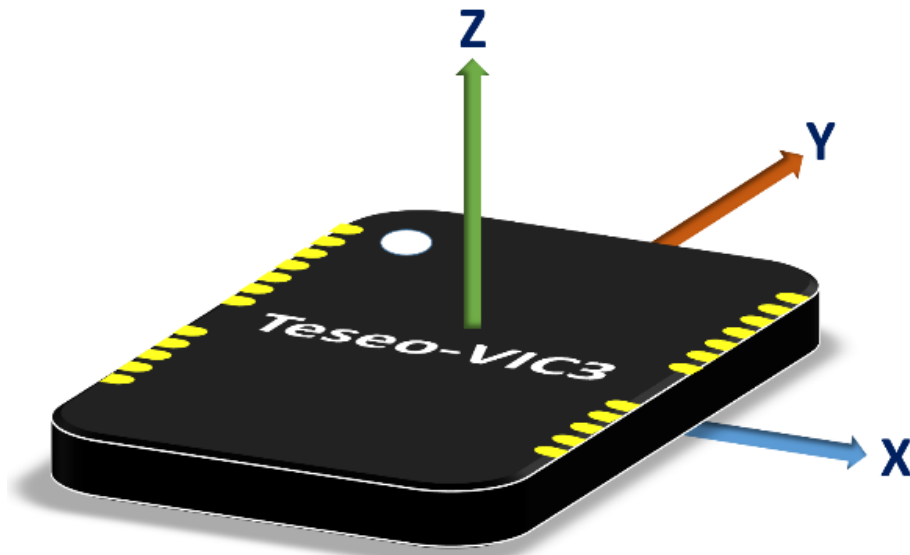

Figure 4. Direction of the detectable angular rates

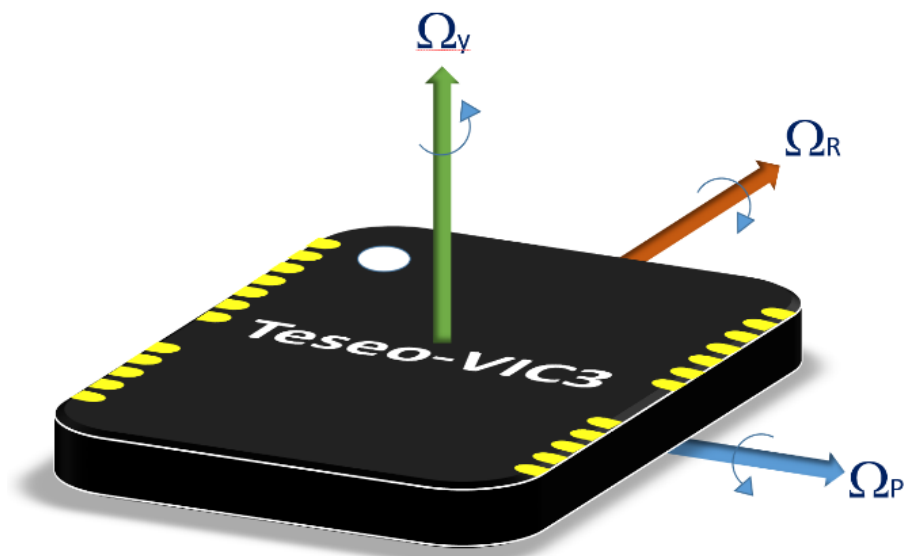

Table 2. Teseo-VIC3D Pin out description

No	Name	I/O	Description
1	WakeUP	I	External Interrupt Pin (if not used, must be left floating)
2	Reserved	-	Reserved
3	PPS	O	Time pulse (PPS)
4	WHEELTICK	I	DRAW Wheel Tick signal (optional)
5	Reserved	-	Reserved
6	IRQ	O	IRQ
7	Reserved	-	NC
8	nReset	I	Input signal to force the module under reset
9	VCC_RF	O	Output Voltage RF section. It can be used to supply external active antenna
10	GND	Ground	Ground
11	RF_IN	I	GNSS signal Input
12	GND	Ground	Ground
13	GND	Ground	Ground
14	Ant_OFF	O	External Antenna Control
15	FWD	I	DRAW Forward signal (optional)
16	Reserved	-	Reserved
17	Reserved	-	Reserved
18	I2C_SDA	I/O	I2C-Data
19	I2C_SCL	I/O	I2C-Clock
20	UART-TX	O	UART-TX
21	UART-RX	I	UART-RX
22	V_BAT	I	Backup voltage supply
23	VCC	I	Supply voltage
24	GND	Ground	Ground

2 Supported GNSS constellations

The embedded FW supports all the GNSS constellations (GPS, GLONASS, GALIELO, BEIDOU and QZSS). The user can select what the application needs by FW configuration; by default, GPS and GLONASS are selected.

2.1 GPS

The Teseo-VIC3D GNSS module is designed to receive and to track the L1C/A signals provided at 1575.42 MHz by the Global Positioning System (GPS). The Teseo-VIC3D can receive and process GPS concurrently with Galileo and GLONASS or BeiDou (the last two are mutually exclusive).

2.2 GLONASS

The Teseo-VIC3D module can receive and process GLONASS concurrently with GPS and Galileo. The Russian GLONASS satellite system (ГЛОНАСС; GLObal NAVigation Satellite System) is an alternative to US's GPS and EU's Galileo.

2.3 BeiDou

The Teseo-VIC3D modules can receive and process BeiDou concurrently with GPS and Galileo. B1 signals provided at 1561.098 MHz by the BeiDou Navigation Satellite System can be tracked by Teseo-VIC3D positioning modules.

2.4 Galileo

The Teseo-VIC3D can receive and process Galileo concurrently with GPS, GLONASS and BeiDou (the last two are mutually exclusive).

3 Augmentation systems

3.1 Satellite-based augmentation system

Teseo-VIC3D supports SBAS. SBAS is a Wide Area Differential GPS (WADGPS), it's a system which provides differential GPS corrections data; SBAS includes the WAAS within the United States, the EGNOS within Europe, the Multifunctional Transport Satellite (MTSAT)-based MSAS within Japan and Southeast Asia, and the GPS and GEO Augmented Navigation (GAGAN) system in India.

SBAS data correction is used in the GNSS algorithm to provide a better position estimation. The overall SBAS differential correction mechanism can be conceived as built in 2 phases:

- The "Acquire and Tracking" phase
- The "Decoding" phase

The "Acquire and Track" phase relates to the capacity of the acquisition engine to reliably track the configured SBAS satellite; during decoding phase the SBAS message can be decoded to fetch the differential corrections.

The current longitude limits for each service are:

- WAAS -180 to -25 degrees
- EGNOS -25 degrees to +50 degrees
- GAGAN +50 degrees to +100 degrees
- MSAS +100 degrees to +180 degrees

The Teseo-VIC3D software with SBAS capability implements a command interface at the NMEA level to allow interaction with the SBAS library. It supports commands to enable/disable the SBAS functionality.

3.2 QZSS

The Quasi-Zenith Satellite System (QZSS) is a Japanese regional communication services and positioning information for the mobile environment in the GPS L1C/A band. QZSS in conjunction with GPS signals provides GNSS augmentation service for the Pacific region covering Japan and Australia. QZSS satellites are placed in a periodic Highly Elliptical Orbit (HEO): these orbits allow the satellites to "dwell" for more than 12 hours a day at an elevation above 70° (it means that they appear almost overhead most of the time).

4 Assisted GNSS

GNSS receivers need accurate satellite position data from at least 4 satellites to produce a fix.

Accurate satellite data -ephemeris data- is valid for 4hrs only for GPS and 30 min only for GLONASS.

After that time, a receiver must download new ephemeris data.

Ephemeris download can take from dozens of seconds to several minutes, hours or can fail to download.

Assisted-GNSS is a mechanism to provide ephemeris assistance from external source; this reduces considerably the time to get fix especially in critical environments when the ephemeris download time could be very long.

Teseo-VIC3D supports two types of assisted GNSS:

- ST assisted GNSS
- Real-time assisted GNSS

4.1 ST assisted GNSS

The ST Assisted GNSS (ST-AGNSS) software, running inside Teseo-VIC3D, can provide predicted ephemeris to the GNSS engine in a time frame less than the usual time (about 30 seconds) needed to download real ephemeris from the sky. This reduces considerably the time to get fix especially in critical environments when the ephemeris download time could be very long.

ST-AGNSS autonomous solution works using the past real ephemeris (downloaded from the sky and stored in its internal database) to extrapolate the parameter of future ephemeris (up to 5 days of prediction). For this reason the ST-AGNSS autonomous performances (in terms of position accuracy using predicted ephemeris) are strictly dependent on the real ephemeris database content. In normal usage of ST-AGNSS autonomous, the system automatically uploads the real ephemeris into its database as soon as new ephemeris are downloaded from the sky. This means that the global content of the real ephemeris input database is determined by the history of the device running periods in the past.

The Teseo-VIC3D software with ST-AGNSS capability implements a command interface at the NMEA level to allow interaction with the ST-AGNSS library. It supports commands to enable/disable the ST-AGNSS functionality or to upload ephemeris and seed into the ST-AGNSS working memory.

4.2 Real-time assisted GNSS

Real-time assisted GNSS (RT-AGNSS) solution is a server based Assisted GNSS, it requires a network connection to download assistance data from the server.

RT-AGNSS works downloading by an assistance server the real-time ephemeris data. Server access is allowed thanks to internal keyword provided by Teseo-VIC3D to the host processor and the acquired real-time data have to be provided to Teseo-VIC3D. Proprietary NMEA commands are supported on Teseo-VIC3D to acquire the credential access to the external server and to inject the data to Teseo-VIC3D.

STMicroelectronics partner provides available server solution access on Teseo-VIC3D solution. Real-time A-GNSS allows continuous real-time satellite position determination.

5 Dead reckoning - Teseo-DRAW

Teseo-VIC3D embeds Teseo dead-reckoning. Automotive Way firmware (Teseo-DRAW) dead-reckoning is a technology combining inertial sensors together with GNSS, providing seamless fusion of satellite measurements, angular rate and acceleration data. It is designed to provide automotive users with improved accuracy, availability and integrity of positioning data, in particular in environments where GNSS is absent or corrupted (tunnels, urban canyon, and so on).

Best Teseo-VIC3D performance is guaranteed providing odometer information using the pins FWD (pin15) and WHEELTICK (pin4).

5.1 High dead reckoning fix rate

While on Teseo-VIC3D the GNSS fix rate is 1 Hz with the the Teseo dead reckoning firmware embedded in Teseo-VIC3D it is possible to achieve a dead reckoning fix rate up to 30 Hz.

5.2 Map matching feedback

Teseo-VIC3D position accuracy can also perform data fusion using data coming from map-navigation-system available on the platform.

5.3 Sensor over UART

Odometer information can be provided to the Teseo-VIC3D not only by pin4 (WHEELTICK) and pin15 (FWD) but also through the UART port using a specific NMEA command.

6 Clock generation

6.1 Temperature Compensated Crystal Oscillator (TCXO)

Highly stable oscillator controls the down conversion process in RF block of the Teseo-VIC3D. Characteristics of this component are important factors for higher sensitivity to maximize performances especially in weak-signal environments, as well as to minimize the Time To First Fix (TTFF) and better navigation stability.

6.2 Real Time Clock (RTC)

This is an always-on power domain dedicated to RTC logic (backup system) and supplied with a dedicated voltage regulator. The RTC provides a high resolution clock. It keeps the time when the system is inactive and it is internally used to wake up the system when in low power mode. It has a clock trimming feature to compensate for the accuracy of the crystal and a secured time update.

7 I/O interfaces

Teseo-VIC3D supports the following I/O interfaces:

- UART port
- I²C port
- GPIOs

NMEA protocol is supported on both UART and I²C ports

7.1 UART

The Universal Asynchronous Receiver/Transmitter (UART) supports much of the functionality of the industry-standard 16C650 UART.

The UART performs serial-to-parallel conversion on data asynchronously received from a peripheral device on the RX pin, and parallel-to-serial conversion on data written by CPU for transmission on the TX pin. The transmit and receive paths are buffered with internal FIFO memories allowing up to 64 data byte for transmission, and 64 data byte with 4-bit status (break, frame, parity, and overrun) for receive.

7.2 I²C

Teseo-VIC3D includes a slave I²C interface configurable; I²C is a two-wire communication interface invented by Philips Semiconductor. Unlike all other interfaces, I²C is not able to communicate in full-duplex mode; it uses only two bidirectional open-drain lines, Serial Data Line on pin I2C_SDA and Serial Clock Line on pin I2C_SCL, pulled up with resistors.

Teseo-VIC3D receiver always acts as slave and it cannot initiate data transmission on the bus; host has to periodically poll the receiver to check about data availability.

The main features are:

- Normal speed (100 KHz) and Fast speed (400 KHz) supported
- I²C-slave address configurable using the firmware configurator

7.3 GPIOs

Teseo-VIC3D includes 4 GPIOs:

- PPS (pin #3)
- IRQ (pin #6)
- WHEELTICK (pin #4) specific for Dead-Reckoning application
- FWD (pin #15) on specific for Dead-Reckoning application

8 FW update support

The Teseo-VIC3D receiver module can be updated with new firmware releases. The latest firmware version is available at www.st.com and it can be installed on Teseo-VIC3D using the available PC Tool Teseo-Suite available at www.st.com.

Detailed information is available on Teseo-VIC3D software user manual.

9 FW configuration

All configuration parameters are grouped in a data block. Each field is addressed by a unique ID. The IDs are made by three digits: the most significant one represents the parameter type and the others are used to identify different parameters of the same type.

Default setting of configuration data block is hard coded into the binary image file.

A new configuration can be built using the PC Tool Teseo-Suite, available at www.st.com or using runtime configuration commands raised by the host.

10 Power mode

Standby mode, is the mode where only low power backup domain is running. It means V_BAT (pin#22) must be always maintained. It allows to have very low current consumption and fast GNSS reacquisition at the end of the standby time due to RTC.

Teseo-VIC3D offers two different ways of standby:

- Software standby
- VCC standby

10.1 Software standby

Software standby is activated by the internal firmware.

Software standby can be:

- Host driven standby: where the host raises a NMEA command to force Teseo-VIC3D in standby; host can wake up Teseo-VIC3D using the Wakeup pin (pin #1);
- Periodic standby: where Teseo-VIC3D enters and exits from standby using internal RTC. Periodic fixes are from 5 seconds up to 24 hours between 2 fixes.

It ensures a current below 30 μ A on Teseo-VIC3D. Be careful that VCC_RF is ON during this standby, then in case of active antenna, it is important to switch them OFF.

10.2 VCC standby

This standby is ensured by switching OFF VCC supply. It can be activated asynchronously from GNSS binary with one GPIO switching OFF the supplies from a host.

11 Regulatory compliance

CE certification for Teseo-VIC3D:

The Teseo-VIC3D module has been certified according to the following standards:

- Radio Equipment Directive (RED) 2014/53/EU
- EN 62368-1:2020/A11:2020
- EN 62479:2010
- ETSI EN 301 489-1 V2.2.0 + ETSI EN 301 489-19 V2.1.0
- ETSI EN 303 413 V1.1.1

The module is provided with the CE marking as you can see in the following figure.

Figure 5. CE marking



The Certificate of Conformity is available/downloadable at the following webpage: www.st.com at the Teseo-VIC3D page.

For additional information please refer to:

STMicroelectronics Via C. Olivetti, 2 Agrate Brianza (MB) 20864 (ITALY)

The Teseo-VIC3D module current production firmware release is: \$PSTMVER,GNSSLIB_8.6.x.xx_ARM*xx

The manufacturer, STMicroelectronics, declares that the Teseo-VIC3D radio equipment complies with the 2014/53/UE directive.

The full text of the EU declaration of conformity is available at the following Internet address: www.st.com at the Teseo-VIC3D page.

12 Electrical characteristics

12.1 Parameter conditions

Unless otherwise specified, all voltages are referred to GND.

12.2 Minimum and maximum values

Unless otherwise specified the minimum and maximum values are guaranteed in the worst conditions of ambient temperature, supply voltage and frequencies by tests in production on 100% of the devices with an ambient temperature at $T_c = 25^\circ\text{C}$.

12.3 Absolute maximum ratings

This product contains devices to protect the inputs against damage due to high static voltages, however it is advisable to take normal precautions to avoid application of any voltage higher than the specified maximum rated voltages.

Table 3. Voltage characteristics

Symbol	Parameter	Min	Typ	Max	Unit
VCC	Digital supply voltage	2.97	3.3	3.63	V
V_BAT	Backup input supply voltage	2.97	3.3	3.63	V

Table 4. Thermal characteristics

Symbol	Parameter	Min	Max	Unit
Toper	Operative ambient temperature	-40	85	$^\circ\text{C}$

Table 5. Power consumption

Symbol	Parameter	Test condition	Typ	Unit
Pw	Power consumption in standard condition	G2 = GPS only; $T_c = 25^\circ\text{C}$; VCC = 3.3 V; V_BAT = 3.3 V	48.8	mA
		G2 = GPS/Glonass; $T_c = 25^\circ\text{C}$; VCC = 3.3 V; V_BAT = 3.3 V	58.6	mA
		G2 = GPS/Beidou; $T_c = 25^\circ\text{C}$; VCC = 3.3 V; V_BAT = 3.3 V	58.1	mA

Symbol	Parameter	Test condition	Typ	Unit
PW _{Standby}	Power consumption STANDBY mode	RTC running = 32.768 KHz; T _c = 25 °C; VCC = V_BAT = 3.3 V	17	μA

12.4 Recommended DC operating conditions

Table 6. Recommended DC operating conditions

Symbol	Parameter	Min	Typ	Max	Unit
VCC	Power supply pins	2.97	3.3	3.63	V
V_BAT	Power supply pins for backup internal logic	2.97	3.3	3.63	V

13 Mechanical specifications

Figure 6. Mechanical specifications (Top view)

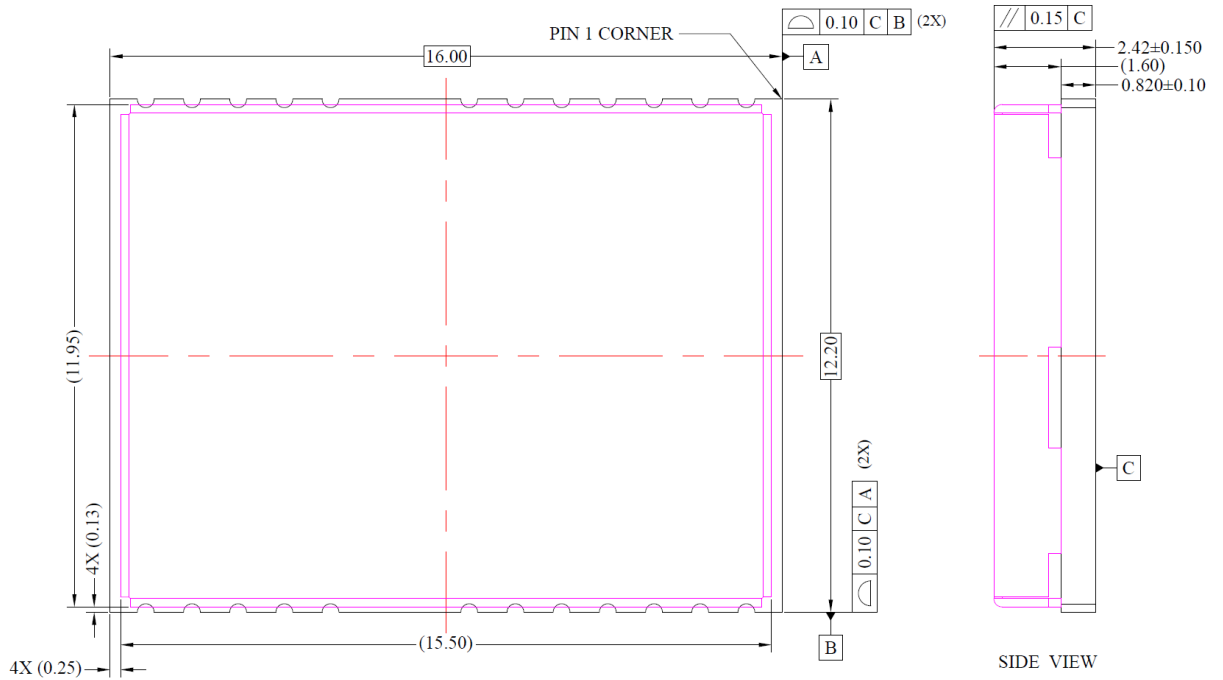

Figure 7. Mechanical specifications (bottom view)

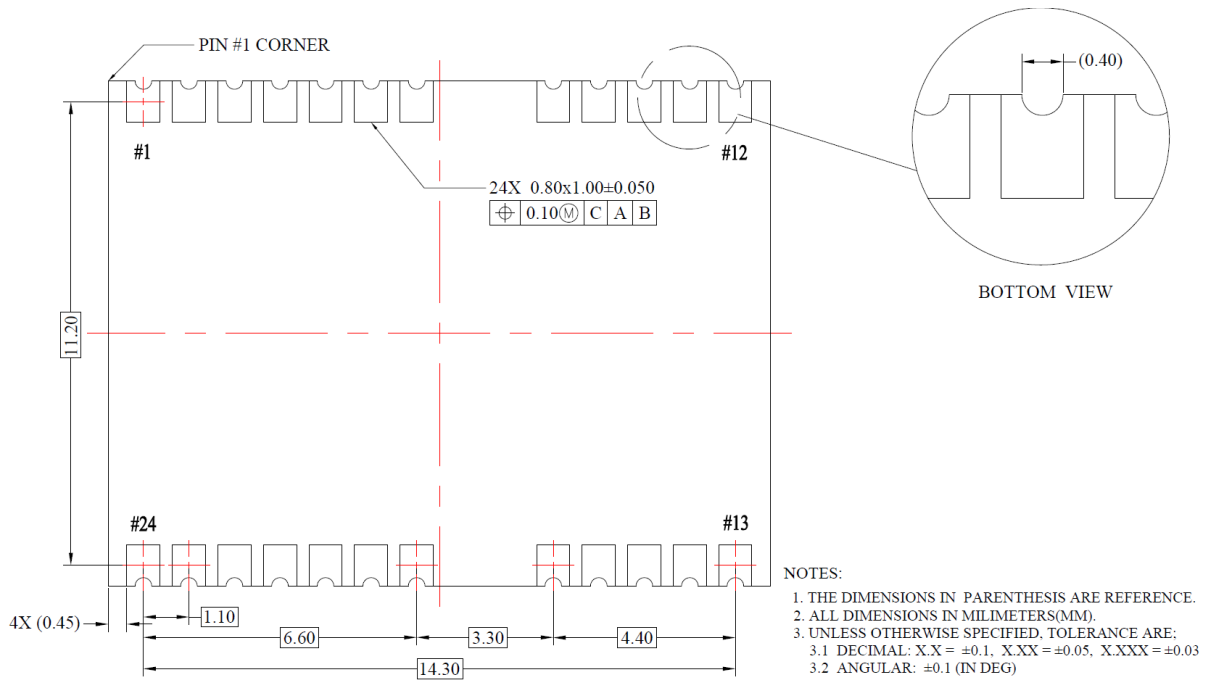

Table 7. Mechanical specifications tolerance

Linear measures		Angle measures	
No decimal	± 1 mm	No decimal	$\pm 0.1^\circ$
.X	± 0.1 mm	-	-
.XX	± 0.05 mm	-	-
.XXX	± 0.03 mm	-	-

14 Shipping information

Teseo-VIC3D is delivered as reeled tapes.

For protection from physical damage, the reels are individually packed in cartons.

14.1 Reels

Figure 8. Reels

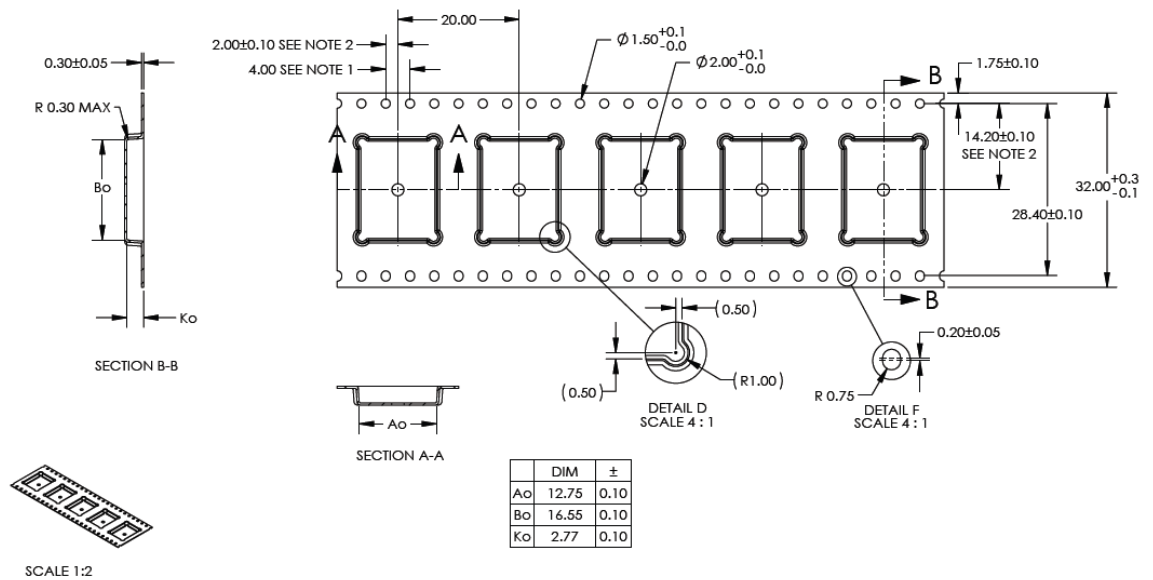

NOTES:

1. 10 SPROCKET HOLE PITCH CUMULATIVE TOLERANCE ± 0.2
2. POCKET POSITION RELATIVE TO SPROCKET HOLE MEASURED AS TRUE POSITION OF POCKET, NOT POCKET HOLE.
3. Ao AND Bo ARE MEASURED ON A PLANE AT A DISTANCE "R" ABOVE THE BOTTOM OF THE POCKET.

14.2 ESD handling precautions

Teseo-VIC3D module is Electrostatic Sensitive Devices (ESD). Observe precautions for handling! Failure to observe these precautions can result in severe damage to the GNSS receiver.

GNSS receivers are Electrostatic Sensitive Devices (ESD) and require special precautions when handling. Particular care must be exercised when handling patch antennas, due to the risk of electrostatic charges.

14.3 Moisture sensitivity levels

The Moisture Sensitivity Level (MSL) relates to the packaging and handling precautions required.

Teseo-VIC3D modules are rated at MSL level 3 (three).

15 Labelling information

The labelling of Teseo-VIC3D reports product information.
Information layout of the product is shown in the following figure.

Figure 9. Labelling information

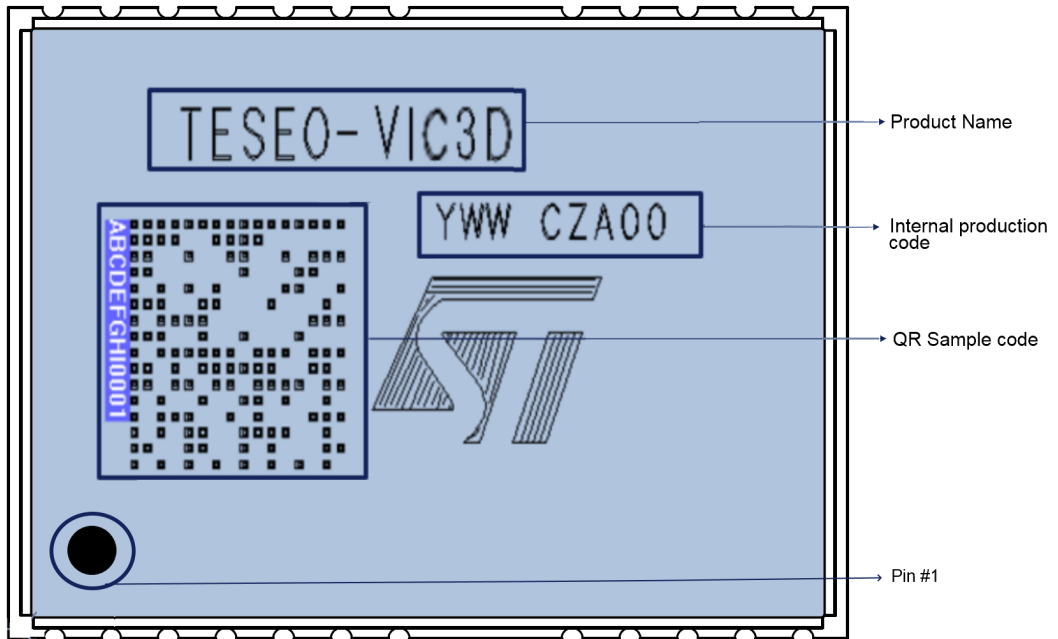

Information description is reported in the following table.

Table 8. Labelling information description

Items	Description
Internal production code	Information code related only to the production line
QR sample code	QR sample code used for traceability information of any parts
Product name	Official product name for ordering code
Pin 1	Identify pin 1

16 Reflow soldering profile

The Teseo-VIC3D is a high temperature strength surface mount GNSS module supplied on a 24 pin, 6-layer PCB. The final assembly recommended reflow profiles are indicated here below.

Soldering phase has to be executed with care: in order to avoid undesired melting phenomenon, particular attention has to be taken on the set up of the peak temperature.

Here following some suggestions for the temperature profile based on the following recommendations.

Table 9. Soldering profile values

Profile feature	PB-free assembly
Average ramp-up rate (T_{SMAX} to T_P)	3 °C/sec max
Preheat:	
– Temperature min (T_{Smin})	150 °C
– Temperature max (T_{Smax})	200 °C
– Time (t_{Smin} to t_{Smax}) (tS)	60-100 sec
Time maintained above:	
– Temperature (T_L)	217° C
– Time (t_L)	60-70 sec
Peak temperature (T_P)	245 +/- 5 °C
Time within 5 °C of actual peak temperature (T_P)	10-20 sec
Ramp-down rate	6 °C/sec
Time from 25 °C to peak temperature	8 minute max.

Figure 10. Soldering profile

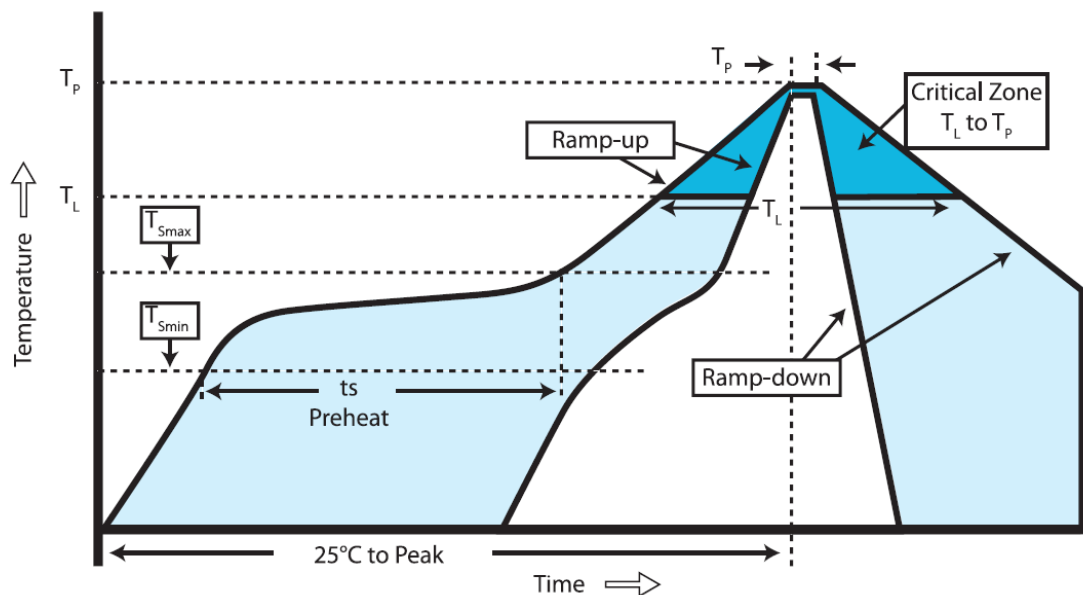

17 Package information

In order to meet environmental requirements, ST offers these devices in different grades of **ECOPACK** packages, depending on their level of environmental compliance. ECOPACK specifications, grade definitions and product status are available at: www.st.com. ECOPACK is an ST trademark.

Revision history

Table 10. Document revision history

Date	Version	Changes
21-Apr-2021	1	Initial release.

Contents

1	Overview	2
1.1	GNSS performance	2
1.2	Block diagram	3
1.3	Pin configuration	3
1.4	Pin out description	4
2	Supported GNSS constellations	6
2.1	GPS	6
2.2	GLONASS	6
2.3	BeiDou	6
2.4	Galileo	6
3	Augmentation systems	7
3.1	Satellite-based augmentation system	7
3.2	QZSS	7
4	Assisted GNSS	8
4.1	ST assisted GNSS	8
4.2	Real-time assisted GNSS	8
5	Dead reckoning - Teseo-DRAW	9
5.1	High dead reckoning fix rate	9
5.2	Map matching feedback	9
5.3	Sensor over UART	9
6	Clock generation	10
6.1	Temperature Compensated Crystal Oscillator (TCXO)	10
6.2	Real Time Clock (RTC)	10
7	I/O interfaces	11
7.1	UART	11
7.2	I ² C	11
7.3	GPIOs	11
8	FW update support	12
9	FW configuration	13

10	Power mode	14
10.1	Software standby	14
10.2	VCC standby	14
11	Regulatory compliance	15
12	Electrical characteristics	16
12.1	Parameter conditions	16
12.2	Minimum and maximum values	16
12.3	Absolute maximum ratings	16
12.4	Recommended DC operating conditions	17
13	Mechanical specifications	18
14	Shipping information	20
14.1	Reels	20
14.2	ESD handling precautions	20
14.3	Moisture sensitivity levels	20
15	Labelling information	21
16	Reflow soldering profile	22
17	Package information	23
	Revision history	24

List of tables

Table 1.	GNSS performance	2
Table 2.	Teseo-VIC3D Pin out description	5
Table 3.	Voltage characteristics	16
Table 4.	Thermal characteristics.	16
Table 5.	Power consumption	16
Table 6.	Recommended DC operating conditions	17
Table 7.	Mechanical specifications tolerance	19
Table 8.	Labelling information description	21
Table 9.	Soldering profile values	22
Table 10.	Document revision history	24

List of figures

Figure 1.	Block schematic	3
Figure 2.	Teseo-VIC3D pins layout	3
Figure 3.	Direction of the detectable accelerations	4
Figure 4.	Direction of the detectable angular rates	4
Figure 5.	CE marking	15
Figure 6.	Mechanical specifications (Top view)	18
Figure 7.	Mechanical specifications (bottom view)	18
Figure 8.	Reels	20
Figure 9.	Labelling information	21
Figure 10.	Soldering profile	22

IMPORTANT NOTICE – PLEASE READ CAREFULLY

STMicroelectronics NV and its subsidiaries (“ST”) reserve the right to make changes, corrections, enhancements, modifications, and improvements to ST products and/or to this document at any time without notice. Purchasers should obtain the latest relevant information on ST products before placing orders. ST products are sold pursuant to ST’s terms and conditions of sale in place at the time of order acknowledgement.

Purchasers are solely responsible for the choice, selection, and use of ST products and ST assumes no liability for application assistance or the design of Purchasers’ products.

No license, express or implied, to any intellectual property right is granted by ST herein.

Resale of ST products with provisions different from the information set forth herein shall void any warranty granted by ST for such product.

ST and the ST logo are trademarks of ST. For additional information about ST trademarks, please refer to www.st.com/trademarks. All other product or service names are the property of their respective owners.

Information in this document supersedes and replaces information previously supplied in any prior versions of this document.

© 2021 STMicroelectronics – All rights reserved