



# EVQ4462-N-00A

## 3.5A, 36V, 4MHz Step-Down Converter Evaluation Board AEC-Q100 Qualified

### DESCRIPTION

The EVQ4462-N-00A is an evaluation board for the MP/MPQ4462, a high frequency step-down regulator with an integrated power MOSFET.

The MP/MPQ4462 integrates a 100mΩ MOSFET that provides 3.5A load current over a wide operating input voltage of 6V to 36V. A 5μA shutdown mode quiescent current allows use in battery-powered applications.

Current mode control provides fast transient response and eases loop stabilization. An internal soft-start prevents inrush current at turn-on.

The MPQ4462 is available in SOIC8E package.

### ELECTRICAL SPECIFICATIONS

Parameter	Symbol	Value	Units
Input Voltage	$V_{IN}$	8 – 36	V
Output Voltage	$V_{OUT}$	3.3	V
Output Current	$I_{OUT}$	3.5	A

### FEATURES

- 3.5A Output Current
- Wide 8V to 36V Operating Input Range
- Adjustable Output from 0.8V to 33V
- Fully Assembled and Tested

### APPLICATIONS

- Game Machines
- Automotive Systems
- Industrial Power Systems
- Distributed Power Systems
- Printer Systems
- Battery Powered Systems

All MPS parts are lead-free, halogen free, and adhere to the RoHS directive. For MPS green status, please visit MPS website under Quality Assurance. "MPS" and "The Future of Analog IC Technology" are Registered Trademarks of Monolithic Power Systems, Inc.

### EVQ4462-N-00A EVALUATION BOARD

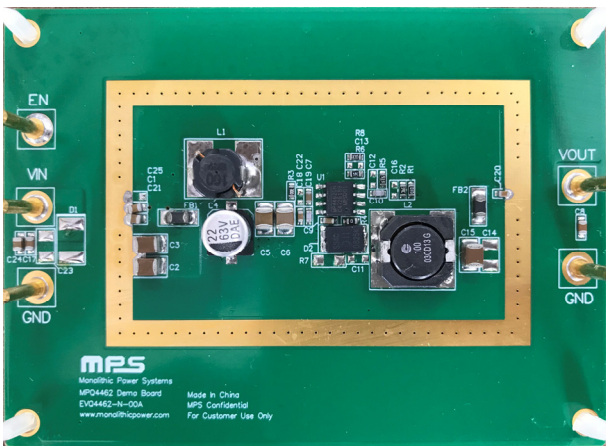

(L x W x H) 1.8" x 1.8" x 0.4"  
(4.6cm x 4.6cm x 1.0cm)

Board Number	MPS IC Number
EVQ4462-N-00A	MP/MPQ4462DN

### Efficiency vs Output Current

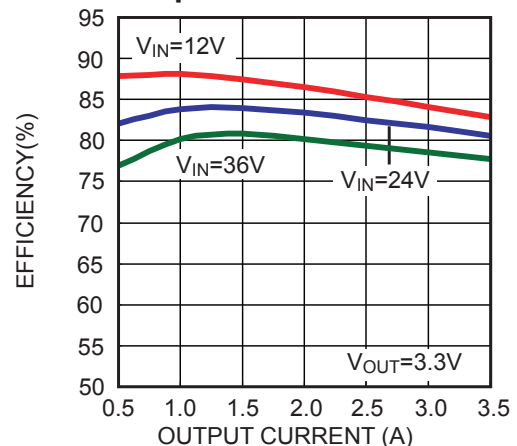

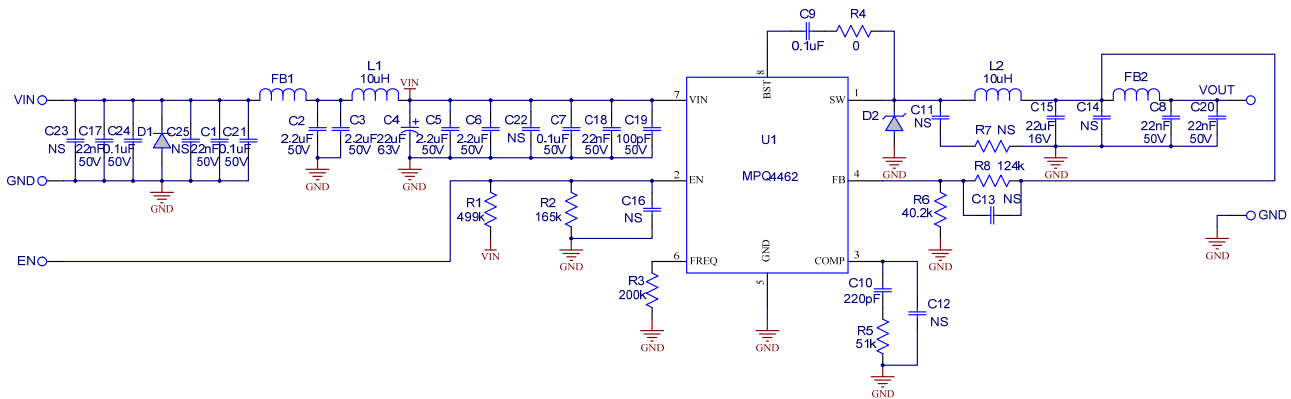
**EVALUATION BOARD SCHEMATIC**

**EVQ4462-N-00A BILL OF MATERIALS**

Qty	Ref	Value	Description	Package	Manufacture	Manufacture_PN
3	C1, C8, C17	22nF	Ceramic Capacitor; 50V; X7R	0805	TDK	C2012X7R1H223K
2	C2, C3	2.2µF	Ceramic Capacitor; 50V; X7R	1210	TDK	C3225X7R1H225K
1	C4	22µF	Electrolytic Capacitor; 63V; Φ6.3mmx7.7mm(H)	SMD	Jianghai	VTD-63V22
2	C5, C6	4.7µF	Ceramic Capacitor; 50V; X7R	1210	TDK	C3225X7R1H475K
2	C7, C9	0.1µF	Ceramic Capacitor; 50V; X7R	0603	TDK	C1608X7R1H104K
1	C10	220pF	Ceramic Capacitor; 50V; X7R	0603	TDK	C1608X7R1H221K
1	C15	22µF	Ceramic Capacitor; 16V; X7R	1210	TDK	C3235X7R1C226M
2	C18, C20	22nF	Ceramic Capacitor; 50V; X7R	0603	TDK	C1608X7R1H223K
1	C19	100pF	Ceramic Capacitor; 50V; C0G	0603	TDK	C1608C0G1H101J
2	C21, C24	0.1µF	Ceramic Capacitor; 50V; X7R	0805	TDK	C2012X7R1H104K
2	C11, C25	NS		0805		
4	C12, C13, C16, C22	NS		0603		
2	C14, C23	NS		1210		
1	D1	NS		SMB		
1	D2	PDS540	Diode Schottky; 40V; 5A	PowerDITM5	Diodes	PDS540

**EVQ4462-N-00A BILL OF MATERIALS (continued)**

Qty	Ref	Value	Description	Package	Manufacture	Manufacture_PN
5	EN, GND1, GND2, VIN, VOUT		2.0 Golden Pin		HZ	
2	FB1, FB2		Magnetic Bead; 6A	1206	muRata	BLM31PG330SH1L
1	L1	10 $\mu$ H	Inductor; 2.7A; Rdc=38m $\Omega$	SMD	TDK	CLF7045T-100M-H
			Inductor; 2.4A; Rdc=45m $\Omega$	SMD	TOKO	DS85LCB-B1135AS-100M
1	L2	10 $\mu$ H	Inductor; 7.2A; Rdc=16.3m $\Omega$	SMD	Würth	7443251000
			Inductor; 4.58A; Rdc=22.5m $\Omega$	SMD	Cooper	DR1050-100R
			Inductor; 4.3A; Rdc=26.5m $\Omega$	SMD	TOKO	D104C-919AQ-100M
1	R1	100k	Film Resistor; 1%	0603	Yageo	RC0603FR-07100KL
1	R2	24.9k	Film Resistor; 1%	0603	Yageo	RC0603FR-0724K9L
1	R3	200k	Film Resistor; 1%	0603	Yageo	RC0603FR-07200KL
1	R4	0	Film Resistor; 5%	0603	Yageo	RC0603JR-070RL
1	R5	51k	Film Resistor; 1%	0603	Yageo	RC0603FR-0768K1L
1	R6	40.2k	Film Resistor; 1%	0603	Yageo	RC0603FR-0740K2L
1	R7	NS		1206		
1	R8	124k	Film Resistor; 1%	0603	Yageo	RC0603FR-07124KL
1	U1		Step-Down Regulator	SOIC8/EP	MPS	MPQ4462DN

## TYPICAL PERFORMANCE CHARACTERISTICS

$V_{IN} = 12V$ ,  $V_{OUT} = 3.3V$ ,  $C5 = 2.2\mu F$ ,  $C6 = 2.2\mu F$ ,  $C15 = 22\mu F$ ,  $L2 = 10\mu H$ ,  $T_A = 25^\circ C$  Unless otherwise noted.

**Efficiency vs. Load Current**

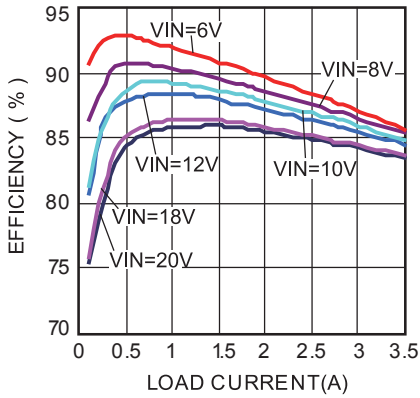

**Load Regulation**

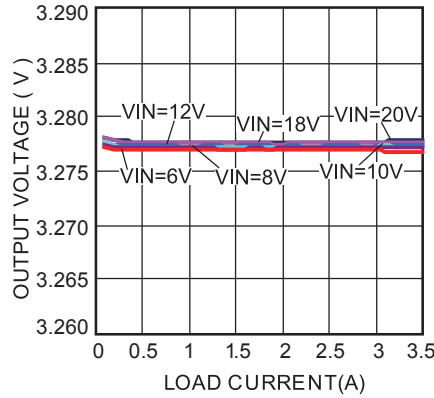

**Line Regulation**

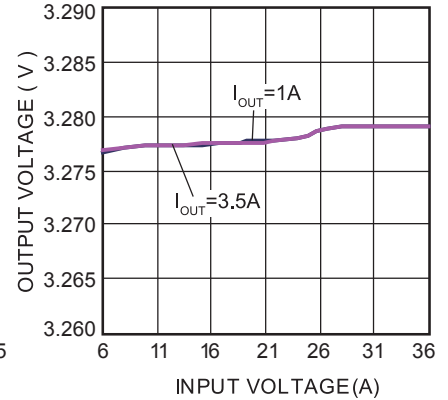

**$I_{PEAK}$  Current vs. Duty Cycle**

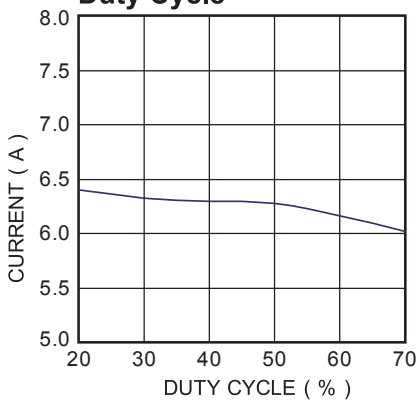

**$I_{PEAK}$  Current vs. Temperature**

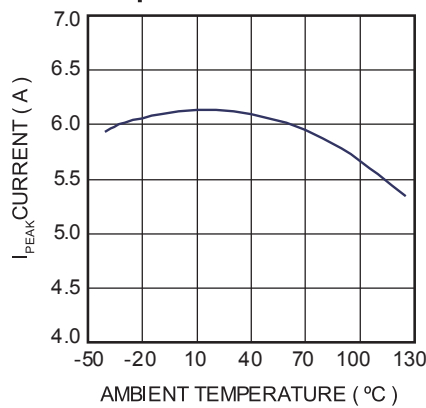

**Switching Frequency vs.  $R_{FREQ}$**

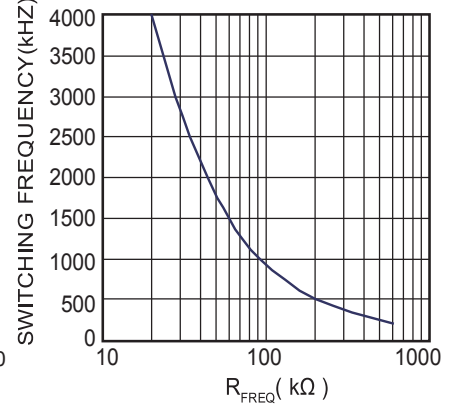

**TYPICAL PERFORMANCE CHARACTERISTICS** (continued)

$V_{IN} = 12V$ ,  $V_{OUT} = 3.3V$ ,  $C5 = 2.2\mu F$ ,  $C6 = 2.2\mu F$ ,  $C15 = 22\mu F$ ,  $L2 = 10\mu H$ ,  $T_A = 25^\circ C$  Unless otherwise noted.

**Power Ramp Up**  
 $I_{OUT} = 3.5A$

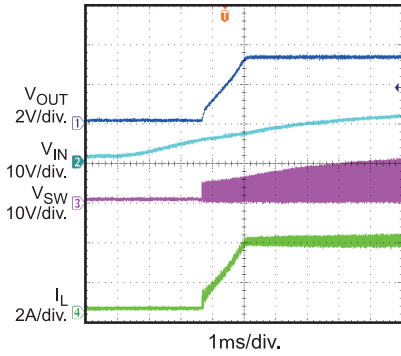

**Power Ramp Down**  
 $I_{OUT} = 3.5A$

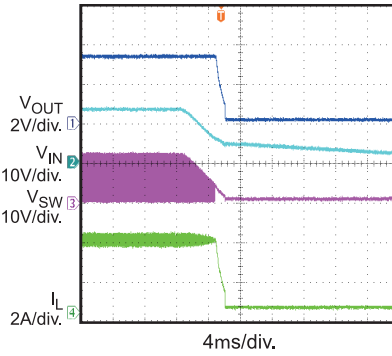

**Short Circuit**

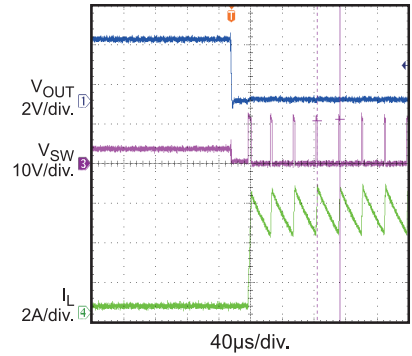

**Steady State**  
 $I_{OUT} = 0.1A$

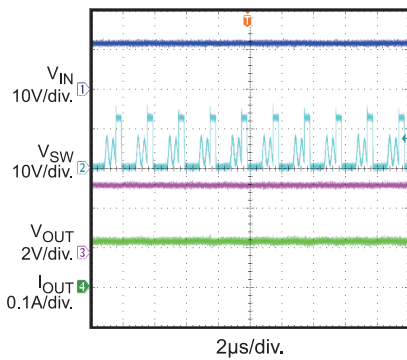

**Steady State**  
 $I_{OUT} = 3.5A$

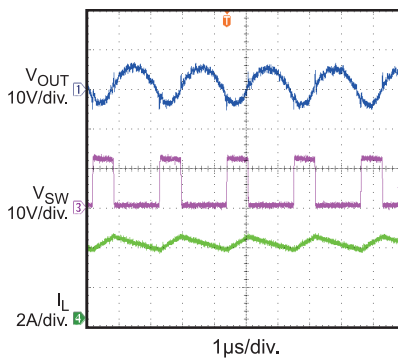

**Transient Response**  
 $I_{OUT} = 2.5A$  to  $3.5A$

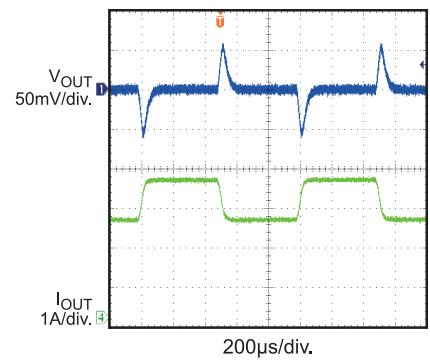

**Enable On**  
 $I_{OUT} = 3.5A$

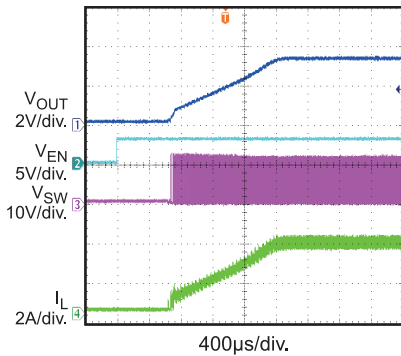

**Enable Off**  
 $I_{OUT} = 3.5A$

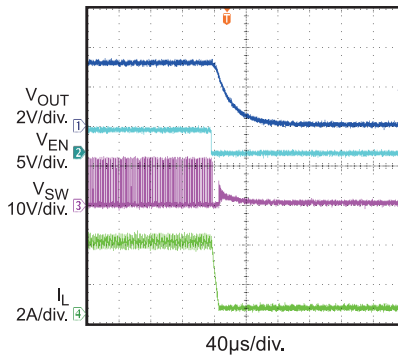

### PRINTED CIRCUIT BOARD LAYOUT

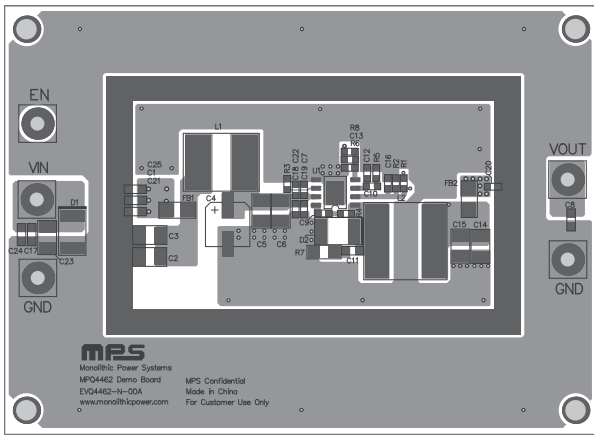

Figure 1: Top Silk and Top Layer

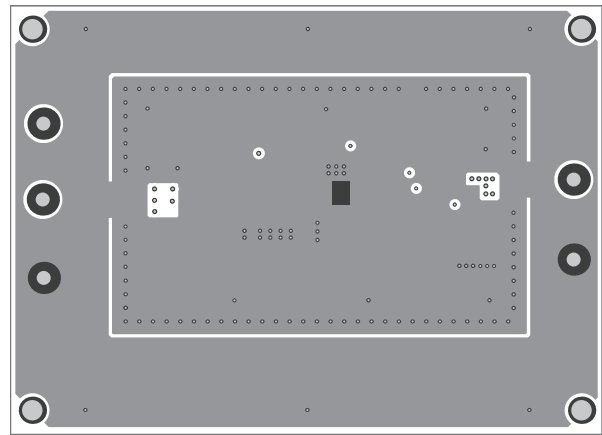

Figure 2: Inner1 Layer

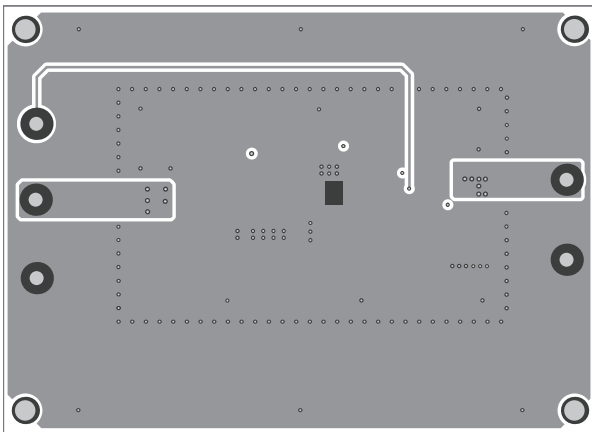

Figure 3: Inner 2 Layer

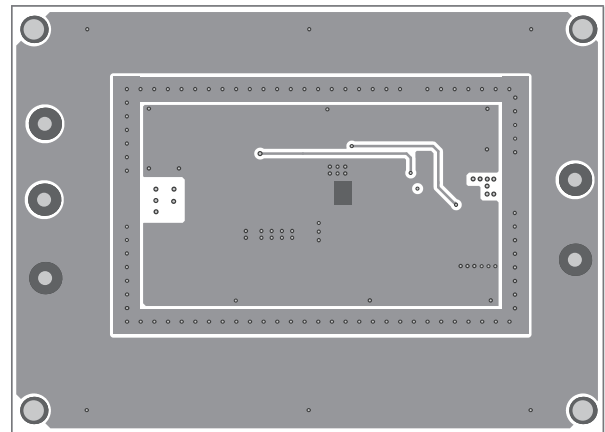

Figure 4: Bottom Silk and Bottom Layer

## QUICK START GUIDE

1. Connect the positive and negative terminals of the load to the VOUT and GND pins, respectively.
2. Preset the power supply output to between 8V and 36V, then turn it off.
3. Connect the positive and negative terminals of the power supply output to the VIN and GND pins, respectively.
4. Turn the power supply on. The MP/MPQ4462DN will automatically startup.
5. To use the Enable function, apply a digital input to the EN pin. Drive EN higher than 1.6V to turn on the regulator, drive EN less than 1.2V to turn it off.
6. An input under voltage lockout (UVLO) function is implemented by the addition of a resistor divider R1 and R2. The EN threshold is 1.2V (falling edge), so  $V_{IN}$  UVLO threshold is  $1.2V \times \left(1 + \frac{R2}{R1}\right)$ . It is preset to 6V on this board.
7. Use R3 to re-program switching frequency if needed,

$$f_s(\text{kHz}) = \frac{70000}{R3(\text{k}\Omega)^{0.93}}$$

The switching frequency is preset to 500kHz on this board. Please note that an external bootstrap diode from 5Vsupply to BST pin is necessary to boost gate drive voltage if switching frequency is above 2MHz because the charge time is reduced at high switching frequency.

8. Use R6 and R8 to set the output voltage with  $V_{FB} = 0.8V$ . For  $R6 = 40.2\text{k}\Omega$ , R8 can be determined by:  $R8 = \frac{40.2}{0.8} \times (V_{OUT} - 0.8)$  (k $\Omega$ ).

Follow the Application Information section in the device datasheet to recalculate the compensation, inductor and output capacitor values when output voltage is changed.

**NOTICE:** The information in this document is subject to change without notice. Users should warrant and guarantee that third party Intellectual Property rights are not infringed upon when integrating MPS products into any application. MPS will not assume any legal responsibility for any said applications.