

## Data sheet

**Connection line M12, D-coded, 3.0 m, AWG 26/19, cat.5, RJ45 plug straight - M12 plug angled, drag chain, torsion, 4-pole, PUR, green**

P/N  
142M4D59030  
EAN 4251394645636  
2021/09/29

### Illustrations



Wiring diagram

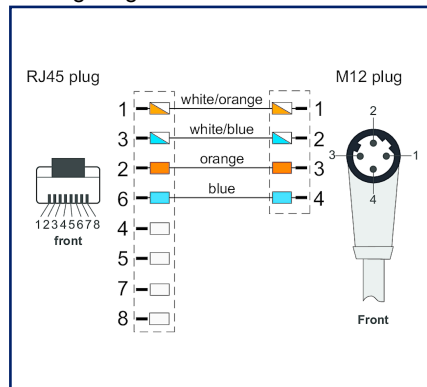

Principle diagram

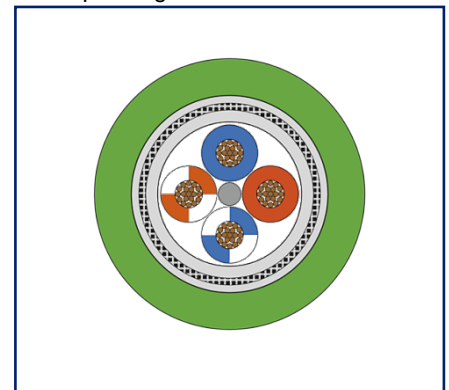

See enlarged drawings at the end of document

### Product specification

Shielded Ethernet cable made of PUR for safe and industrial data transmission in automation and fieldbus technology. Real-time requirements based on IEC61158 can be realized. The cable meets the requirements of UL-Style 21815 (80°/300V) and Cat5 (electrical properties based on EN50288-2-2). Materials and design for increased mechanical stress (abrasion, bending, vibration, etc.) of the cable. Can be used in drag chain operation/torsion. High tensile strength due to incorporated Kevlar thread. Special properties: seawater-resistant, recyclable, LABS-free, RoHS-compliant, acid- and alkali-resistant, ozone-resistant, UV-resistant, hydrolysis-resistant, drag chain-compatible, halogen-free, oil-resistant, high flexibility, microbe-resistant.

- shielded M12 Ethernet cable
- coding: cat.5, 4-pole, D-coded according to IEC 61076-2-101
- side 1: RJ45 plug, overmolded
- side 2: M12 plug angled, cable outlet at the bottom, coding at the top left 315°
- outer diameter sheath: (4.8 ± 0.2) mm
- material: PUR
- wire colors: 1 WHOG, 2 WHBU, 3 OG, 4BU
- wire cross-section/strand construction: AWG26/19 4x1x0.15
- torsion: +/-180°/m, = 5 million cycles
- drag chain capable: max. 5m/s², 3 million cycles

# P | Cabling

Data sheet

Page 2/6

**Connection line M12, D-coded, 3.0 m, AWG 26/19, cat.5, RJ45 plug straight - M12 plug angled, drag chain, torsion, 4-pole, PUR, green**

P/N  
142M4D59030  
EAN 4251394645636  
2021/09/29

## Technical Data

### General Data

Fields of application	Industrial Ethernet
Design	Ethernet-Connection line
Shielding	shielded
Transmission technology	Copper
Cable Type	S/UTP
Number of twisting elements	4
Twisting element	single core
Wiring	PROFINET
Color coding fiber/ wire(s)	white/orange, white/blue, orange, blue
Color	green
Dimensions	
Dimension - Interface 1 (L x W x H)	45.5 mm x 13.3 mm x 13.6 mm
Dimension - Interface 1 (L x W x H)	1.791 in. x 0.524 in. x 0.535 in.
Dimension - Interface 2 (L x W x H)	37.5 mm x 35.3 mm x 15 mm
Dimension - Interface 2 (L x W x H)	1.476 in. x 1.39 in. x 0.591 in.
Cable length (m)	3 m
Cable length (ft)	9.84 ft
Labeling option	identification label carrier

### Transmission characteristics

Category (ISO)	5e
Transmission rate up to 100 MBit (Fast Ethernet)	IEEE 802.3u

### Connections/interfaces

Connector technology interface 1	RJ45 plug
Connector technology interface 2	M12-plug
Coding interface 2	D-coded
Number of positions/contacts interface 1	8P/4C
Number of positions/contacts interface 2	4

# P | Cabling

Data sheet

Page 3/6

**Connection line M12, D-coded, 3.0 m, AWG 26/19, cat.5, RJ45 plug straight - M12 plug angled, drag chain, torsion, 4-pole, PUR, green**

P/N  
142M4D59030  
EAN 4251394645636  
2021/09/29

## Technical Data

### Connections/interfaces

Termination data, stranded wire (min. - max.)

Conductor cross section, stranded wire	AWG 26/19
Conductor diameter, stranded wire (bare copper)	0.5 mm
Conductor diameter, stranded wire (bare copper)	0.02 in.
Cable sheath diameter (min. - max.)	
Cable sheath diameter	4.8 mm
Cable sheath diameter	0.189 in.

### Electrical characteristics

Current carrying capacity	1 A bei 40 °C
Rated voltage	60 V DC
Insulation resistance	min. 100 MOhm

### Mechanical data

Life - Number of mating cycles	min. 100
Torsion	min. $\pm 30$ °/m
Bending radius without load	min. 36 mm
Maximum operating bending radius	19.2 mm
Maximum operating bending radius	0.756 in.
Maximum installation load	36 mm
Number of alternating bending cycles (mechanical resistance) at:	5 million bending cycles
Alternating bending radius	36 mm
velocity	180 m/s
acceleration	5 m/s <sup>2</sup>
Shielding braid coverage	85 %

### Materials and material properties

Material - Conductor	Cu (copper)
Material - Conductor Insulation	polypropylene
Material - Cable jacket	PUR
Material - Body interface 1	Plastics
Material - Body interface 2	Plastics
Material - Contact interface 1	CuSn (tin bronze)

# P | Cabling

Data sheet

Page 4/6

**Connection line M12, D-coded, 3.0 m, AWG 26/19, cat.5, RJ45 plug straight - M12 plug angled, drag chain, torsion, 4-pole, PUR, green**

P/N  
142M4D59030  
EAN 4251394645636  
2021/09/29

## Technical Data

### Materials and material properties

Material - Contact interface 2	CuSn (tin bronze)
Material - Contact finish interface 1	Au (gold)
Material - Contact finish interface 2	Au (gold)
Material - Contact carriers interface 1	Plastics
Material - Contact carriers interface 2	Plastics
Material - Union nut interface 2	CuZnPb (brass)
Material - Union nut finish interface 2	Ni (nickel)
Material - Pair shield	plastic film
Material - Pair shield finish	Al (Aluminium)
Material - Main shield	Cu (copper) braid
Material - Main shield finish	Sn (tin)
Flame retardancy	yes
Halogen free	yes
Silicone free	yes
Oil resistance	yes
UV-resistance	yes
rag chain suitable	yes
capable of torsion	yes
RoHS	compliant
REACH - substance (SVHC)	Lead / 7439-92-1

### Environmental conditions

Temperature (min. - max.)	
Temperature - Operating °C	-30 °C - 70 °C
Temperature - Operating °F	-22 °F - 158 °F
Particulate ingress interface 1	IP2X when plugged in
Liquid ingress/immersion interface 1	IPX0 when plugged in
Particulate ingress interface 2	IP6X when plugged in
Liquid ingress/immersion interface 2	IPX5, IPX7, IPX8 when plugged in
Pollution degree interface 1	1
Pollution degree interface 2	3

# P | Cabling

Data sheet

Page 5/6

**Connection line M12, D-coded, 3.0 m, AWG 26/19, cat.5,  
RJ45 plug straight - M12 plug angled,  
drag chain, torsion, 4-pole, PUR, green**

P/N  
142M4D59030  
EAN 4251394645636  
2021/09/29

## Technical Data

### Approvals

CE	compliant
UL listed (file no.)	Approval pending

### The product meets the following standards

Generic cabling systems	
General requirements	ISO/IEC 11801-1   DIN EN 50173-1
PROFINET	yes
Connectors for electronic equipment	
circular connector	DIN EN 61076-2-101
Multi-element metallic cables used in analogue and digital communication and control	DIN EN 50288-4-1
Test for vertical flame propagation for a single insulated wire or cable	IEC 60332-1-2
Measurement of smoke density of cables burning	DIN EN 61034

### Classifications

ETIM 7.0	EC002599
ETIM 8.0	EC002599

### Packing details

Type of packaging	1 pc(s) / plastic bag
-------------------	-----------------------

# P | Cabling

Data sheet

Page 6/6

**Connection line M12, D-coded, 3.0 m, AWG 26/19, cat.5,  
RJ45 plug straight - M12 plug angled,  
drag chain, torsion, 4-pole, PUR, green**

P/N

142M4D59030

EAN 4251394645636

2021/09/29

## Illustrations

Wiring diagram

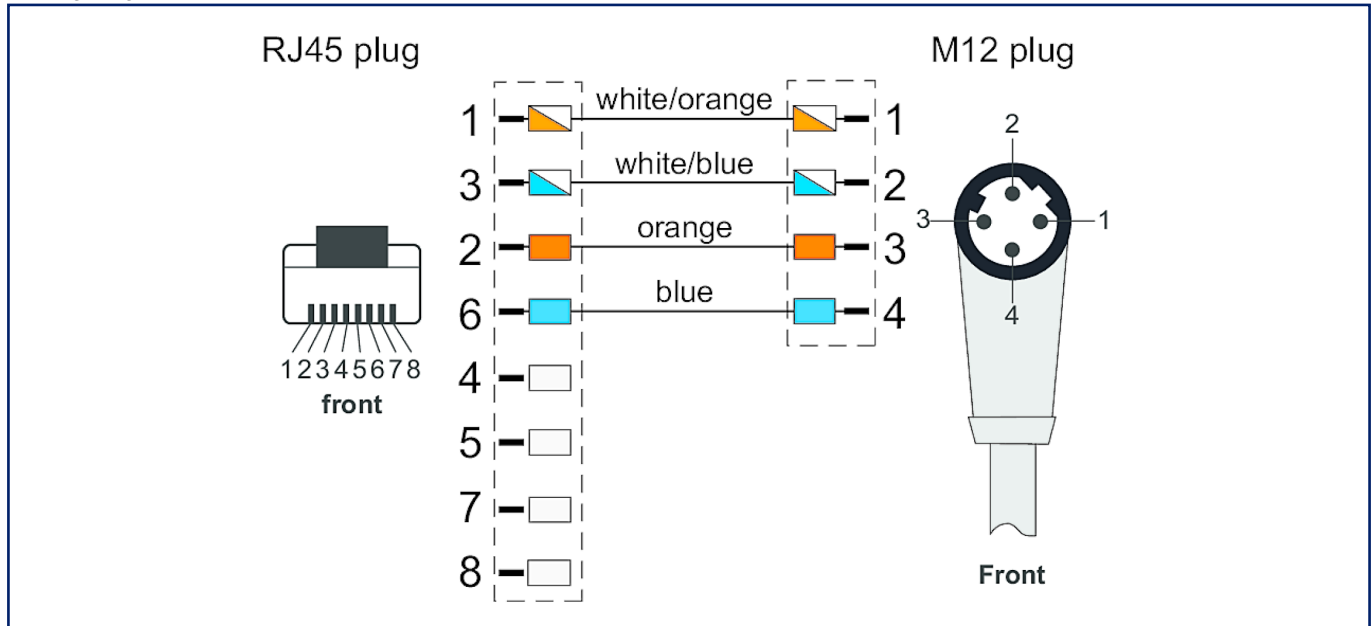

Principle diagram

