



Title	<i>Reference Design Report for a 6 W Isolated Flyback Power Supply with Lossless Generation of AC Zero Cross Signal Using LinkSwitch™-TNZ LNK3306D</i>
Specification	90 VAC – 305 VAC Input, 12 V, 0.5 A Output
Application	Home Appliance and Industrial Power
Author	Applications Engineering Department
Document Number	RDR-877
Date	July 25, 2021
Revision	1.2

Summary and Features

- Meets all existing and proposed energy efficiency standards including ErP
- No-load consumption <30 mW across AC line
- More than 350 mW available in stand-by while meeting 500 mW max input power
- Active mode efficiency meets DOE6 and EC CoC (v5)
- Highly integrated solution with LNK3306D
- Low-component count with integrated 725 V power MOSFET, current sensing and protection
- Wide-range AC input
- Isolated Zero-crossing signal output synchronized to AC line
- >80% full-load efficiency at nominal lines
- Meets EN550022 and CISPR-22 Class B conducted EMI

PATENT INFORMATION

The products and applications illustrated herein (including transformer construction and circuits external to the products) may be covered by one or more U.S. and foreign patents, or potentially by pending U.S. and foreign patent applications assigned to Power Integrations. A complete list of Power Integrations' patents may be found at www.power.com. Power Integrations grants its customers a license under certain patent rights as set forth at <https://www.power.com/company/intellectual-property-licensing/>.

Power Integrations

5245 Hellyer Avenue, San Jose, CA 95138 USA.
Tel: +1 408 414 9200 Fax: +1 408 414 9201
www.power.com

Table of Contents

1	Introduction	5
2	Power Supply Specification	6
3	Schematic.....	7
4	Circuit Description	8
4.1	Input Rectifier and Filter	8
4.2	LNK3306 Operation.....	8
4.3	Output Rectification and Filtering.....	8
4.4	Feedback and Output Voltage Regulation	9
4.5	Output Overvoltage Shutdown.....	9
4.6	Zero Crossing Detection	9
4.7	EMI Design Aspects	10
4.8	NPN Solution	10
5	PCB Layout	11
6	Bill of Materials	12
7	Transformer Specification	13
7.1	Electrical Diagram.....	13
7.2	Electrical Specifications	13
7.3	Material List	13
7.4	Transformer Build Diagram	14
7.5	Transformer Instructions.....	14
7.6	Transformer Winding Illustrations.....	15
9	Transformer Design Spreadsheet	18
10	Performance Data	21
10.1	Efficiency	21
10.1.1	Active Mode Measurement Data.....	21
10.1.2	Full Load Efficiency vs. Line	22
10.1.3	Efficiency vs. Load	23
10.2	Available Standby Output Power	24
10.3	No-Load Input Power.....	26
10.4	Line Regulation.....	27
10.5	Load Regulation	28
11	Waveforms	29
11.1	Zero Crossing Detection	29
11.1.1	Zero Crossing Detection at Normal Operation	29
11.1.1.1	100% Load	29
11.1.1.2	0% Load.....	30
11.1.2	Zero Crossing Detection at Start-up	31
11.1.2.1	0° Start-up Phase.....	31
11.1.2.2	90° Start-up Phase.....	32
11.1.3	Zero Crossing Detection Delay	33
11.2	Zero Crossing Detection using NPN Solution	34
11.2.1	Zero Crossing Detection at Normal Operation	34
11.2.2	Zero Crossing Detection Delay	35



11.3	Load Transient Response	36
11.3.1	0% - 100% Load Change	36
11.3.2	50% - 100% Load Change	37
11.4	Output Voltage at Start-up	38
11.4.1	CC Mode	38
11.4.1.1	100% Load	38
11.4.1.2	0% Load.....	39
11.4.2	CR Mode	40
11.4.2.1	100% Load	40
11.4.2.2	0% Load.....	41
11.5	Switching Waveforms.....	42
11.5.1	Primary MOSFET Drain-Source Voltage and Current at Normal Operation .	42
11.5.1.1	100% Load	42
11.5.1.2	0% Load.....	43
11.5.2	Primary MOSFET Drain-Source Voltage and Current at Start-up Operation	44
11.5.2.1	100% Load	44
11.5.2.2	0% Load.....	45
11.5.3	Output Diode Voltage and Current at Normal Operation	46
11.5.3.1	100% Load	46
11.5.3.2	0% Load.....	47
11.5.4	Output Diode Voltage and Current at Start-up Operation	48
11.5.4.1	100% Load	48
11.5.4.2	0% Load.....	49
11.6	Brown-In and Brown-Out	50
11.6.1	Brown-in	50
11.6.2	Brown-out	50
11.7	Fault Conditions.....	51
11.7.1	Output Overvoltage.....	51
11.7.1.1	100% Load	51
11.7.1.2	0% Load.....	52
11.7.2	Output Short-Circuit	53
11.8	Output Voltage Ripple	54
11.8.1	Ripple Measurement Technique	54
11.8.2	Measurement Results	55
11.8.2.1	100% Load Condition	55
11.8.2.2	75% Load Condition	56
11.8.2.3	50% Load Condition	57
11.8.2.4	25% Load Condition	58
11.8.2.5	0% Load Condition	59
11.8.3	Output Ripple Voltage Graph from 0% - 100%	60
12	Thermal Performance.....	61
12.1	Test Set-Up.....	61
12.2	Thermal Performance at Room Temperature	62
12.2.1	90 VAC at Room Temperature	62



12.2.2	115 VAC at Room Temperature.....	63
12.2.3	230 VAC at Room Temperature.....	64
12.2.4	300 VAC at Room Temperature.....	65
13	Conducted EMI	66
13.1	Test Set-up Equipment	66
13.1.1	Equipment and Load Used.....	66
13.2	Test Set-up	66
13.3	Test Results	67
14	Line Surge.....	68
14.1	Surge.....	68
14.2	Ring Wave	68
15	Revision History	69

Important Note: Although this board is designed to satisfy safety isolation requirements, the engineering prototype has not been agency approved. Therefore, all testing should be performed using an isolation transformer to provide the AC input to the prototype board.

1 Introduction

This engineering report describes an isolated flyback converter designed to provide a nominal output voltage of 12 V at 0.5 A load from a wide input voltage range of 90 VAC to 305 VAC, as well as an isolated zero crossing detection (ZCD) signal. This power supply utilizes the LNK3306D from the LinkSwitch-TNZ family of ICs.

This document contains the complete power supply specifications, bill of materials, transformer construction, circuit schematic and printed circuit board layout, along with performance data and electrical waveforms.



Figure 1 – Populated Circuit Board, Top View.

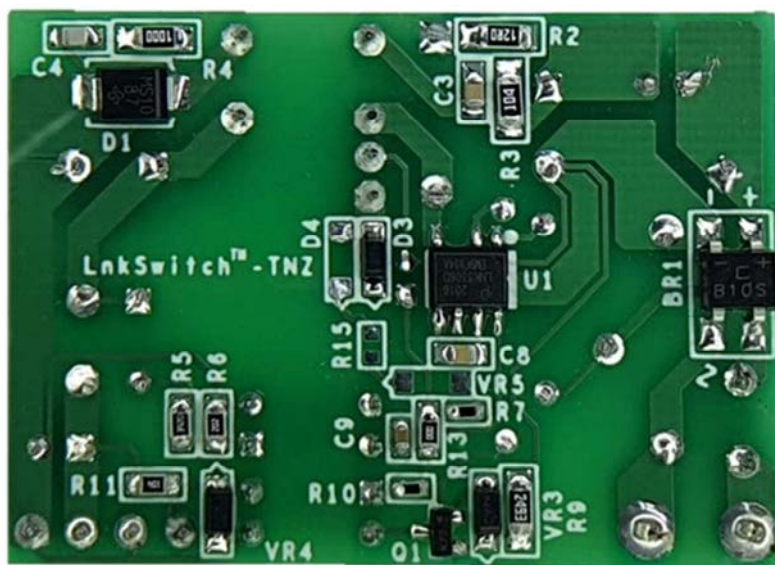

Figure 2 – Populated Circuit Board, Bottom View.

2 Power Supply Specification

The table below represents the minimum acceptable performance of the design. Actual performance is listed in the results section.

Description	Symbol	Min	Typ	Max	Units	Comment
Input						
Voltage	V_{IN}	90		305	VAC	2 Wire – no P.E.
Frequency	f_{LINE}	47	50/60	64	Hz	
No-load Input Power				25	mW	230 VAC.
Output						
Output Voltage	V_{OUT}	10.8	12	13.2	V	±10%
Output Ripple Voltage	V_{RIPPLE}			100	mV	20 MHz Bandwidth.
Output Current	I_{OUT}		0.5		A	
Total Output Power						
Continuous Output Power	P_{OUT}		6		W	
Efficiency						
Full Load	η		80		%	Measured at P_{OUT} 25 °C.
Environmental						
Conducted EMI		Meets CISPR22B / EN55022B				
Safety		Designed to meet IEC 60950, UL 60950-1				
Surge			1		kV	1.2/50 μ s surge, IEC 1000-4-5, Series Impedance: Surge: 2 Ω .
Ring Wave			2.5		kV	Ring Wave: 12 Ω .



3 Schematic

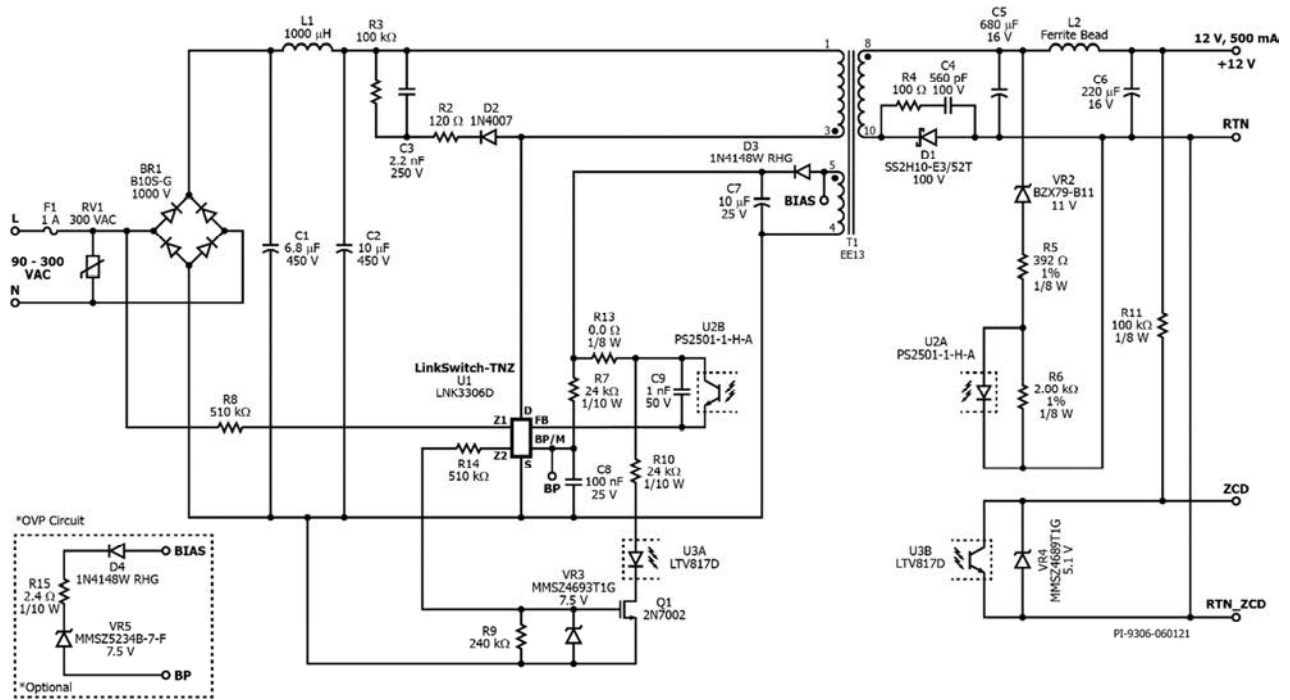

Figure 3 – Schematic.

4 Circuit Description

This circuit is configured as a flyback topology power supply utilizing the LNK3306D. Secondary-side constant voltage (CV) regulation is accomplished through optocoupler feedback with a Zener reference.

4.1 *Input Rectifier and Filter*

Input fuse F1 provides safety protection from component failures. Varistor RV1 acts as a voltage clamp that limits the voltage spike across the DC bus during line transient surge events. The AC input voltage is rectified by input bridge BR1. The rectified DC is then filtered by the bulk storage capacitors C1 and C2. Inductor L1, C1 and C2 form an input pi filter, which attenuates differential mode conducted EMI.

4.2 *LNK3306 Operation*

The LNK3306D device U1 integrates the power switching device, oscillator, control, start-up, and protection functions.

The rectified and filtered input voltage is applied to the primary winding of T1. One side of the power transformer (T1) primary winding is connected to the positive leg of C2, and the other side is connected to the DRAIN (D) pin of U1. At the start of a switching cycle, the controller turns the power MOSFET on and current ramps up in the primary winding, delivering energy from bulk capacitor to transformer. When that current reaches the limit threshold, the controller turns the power MOSFET off. Due to the phasing of the transformer windings and the orientation of the output diode, the stored energy is delivered to the output capacitor during off time.

When the power MOSFET turns off, the leakage inductance of the transformer induces a voltage spike on the drain node. The amplitude of that spike is limited by an RCD clamp network that consists of D2, C3, R2 and R3. Resistor R2 and R3 not only damp the high frequency leakage ring that occurs when the power MOSFET turns off, but also limit the reverse current through D1 when the power MOSFET turns on. This allows a slow, low-cost, glass passivated diode (with a recovery time of $\leq 2 \mu\text{s}$.) to be used for D2. The slow diode also improves conducted EMI and efficiency.

Using ON/OFF control, U1 skips switching cycles to regulate the output voltage, based on feedback to FB pin. The FB pin current is sampled, just prior to each switching cycle, to determine if that switching cycle should be enabled or disabled. If the FB pin current is $< 49 \mu\text{A}$, the next switching cycle begins, and is terminated when the current through the power MOSFET reaches the internal current limit threshold.

4.3 *Output Rectification and Filtering*

Output rectification is provided by D1. Low ESR capacitor C5 achieves minimum output voltage ripple and noise in a small can size for the rated ripple current specification. A



post filter (ferrite bead L2 and C6) attenuates noise and ripple further to meet the specification.

4.4 **Feedback and Output Voltage Regulation**

The supply's output voltage regulation set point is set by the voltage that develops across Zener diode VR2, R5 and the LED in optocoupler U2. The value of R6 was calculated to bias VR2 to about 0.5 mA when it goes into reverse avalanche conduction. This ensures that it is operating close to its rated knee current. Resistor R5 limits the maximum current during load transients. The values of R5 and R6 can both be varied slightly to fine-tune the output regulation set point. When the output voltage rises above the set point, the LED in U2 becomes forward biased. On the primary-side, the photo-transistor of U2 turns on and injects current into the FB pin of U1. Just before the start of each switching cycle, the controller checks the FB pin current. If the current flowing out of the EN/UV pin is greater than 49 μ A, that switching cycle will be disabled. As switching cycles are enabled and disabled, the output voltage is kept very close to the regulation set point.

4.5 **Output Overvoltage Shutdown**

PI's proprietary primary overvoltage detection eliminates the use additional optocoupler and enables to low voltage rated output. It is accomplished by sensing the switching bias winding voltage during power MOSFET off time. When the power MOSFET is off, the reflected voltage on the bias winding is proportional to the output voltage by a factor determined by the bias and output turns ratio. When this voltage exceeds the sum of VR5, forward voltage of D4, and the BYPASS (BP) pin voltage, an overvoltage condition occurs and current begins to flow into the BYPASS pin. When this current exceeds 6 mA the internal shutdown circuit in U1 is activated. Reset is accomplished by allowing the BYPASS pin voltage to drop below 2 V. Resistor R15 can be used to fine tune the overvoltage limit.

4.6 **Zero Crossing Detection**

During normal operation when AC input is present, the Z1 and Z2 pins draw 22 μ A as its supply current. The AC Line node is directly sensed by resistor R8, and resistors R9 and R14 are returned to primary ground. The supply current then goes thru the input bridge BR1, before returning to the AC Neutral node. Due to the presence of BR1, Z1 and Z2 pins can only conduct and draw supply current during the positive half of the AC cycle. The diode in BR1 will be reverse biased during the negative half cycle.

When Z1-Z2 conducts during the AC positive half-cycle, MOSFET Q1 is turned on by the voltage across R9. Zener diode VR3 protects Q1 gate-source from excessive high-voltage during transients. MOSFET Q1 then switches optocoupler U3 and current-limiting resistor R10. On the secondary-side, the ZCD output is pulled low by the transistor in U3. During the AC negative half-cycle, Z1-Z2 is prevented from conducting by bridge BR1, so both MOSFET Q1 and optocoupler U3 are also turned off. At the secondary-side, pull-up resistor R11 and Zener diode VR4 clamp the ZCD output to 5 V.



4.7 ***EMI Design Aspects***

In addition to the simple input π filter (C1, L1 and C2) for differential mode EMI, this design makes use of shielding techniques in the transformer to reduce common mode EMI displacement currents. Resistor R3 and capacitor C3 are added to act as damping network to reduce high frequency transformer ringing. These techniques combined with the frequency jitter of LNK3306D gives excellent conducted EMI performance.

4.8 ***NPN Solution***

An NPN BJT can be used as a low cost alternative solution to using a MOSFET for Q1. If an NPN BJT is used, Zener diode VR3 can be removed from the schematic, because the base-emitter junction will inherently limit the voltage across its terminals.

The generation of a ZCD signal will work with the same principles as discussed in section 4.6. The difference, however, is that since the NPN can be thought of as a current-dependent switch, the current transfer ratio (β) will determine the optocoupler series resistor R10 and the base-emitter pulldown resistor R9. Recommended values for R9 and R10 will be shown under the waveforms section.

5 PCB Layout

PCB board thickness: 0.062"

Material: FR4

Copper: 2oz

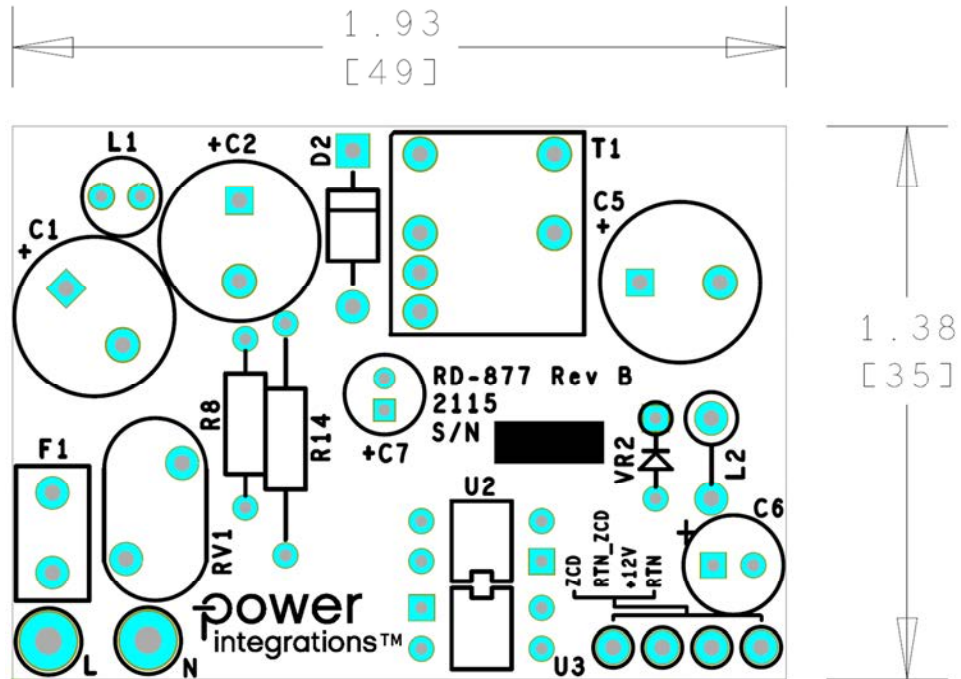

Figure 4 – Populated Circuit Board, Top View.

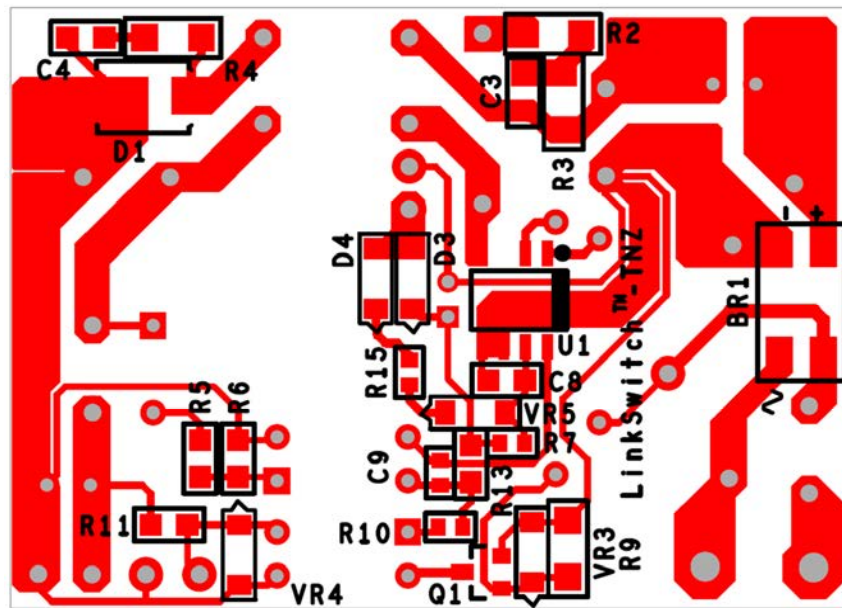

Figure 5 – Populated Circuit Board, Bottom View.



6 Bill of Materials

Item	Qty	Ref Des	Description	Mfg Part Number	Mfg
1	1	BR1	1000 V, 0.8 A, Bridge Rectifier, SMD, MBS-1, 4-SOIC	B10S-G	Comchip
2	1	C1	6.8 μ F, \pm 20%, 450V Aluminum Electrolytic Radial, Can 10000 Hrs @ 105°C (10 x 17.5)	EKXJ451ELL6R8MJ16S	United Chemi-Con
3	1	C2	10 μ F, 20%, 450 V, Electrolytic, Gen. Purpose, (10 x 16), 10000Hr @105C	450BXW10MEFR10X16	Rubycon
4	1	C3	2.2 nF, 250 V, Ceramic, X7R, 0805	C2012X7R2E222K085AA	TDK
5	1	C4	560 pF, \pm 5%, 100 V, General Purpose, Ceramic, COG, NP0, 0805	CC0805JRNPO0BN561	Yageo
6	1	C5	680 μ F, 16 V, Electrolytic, Very Low ESR, 38 m Ω , (10 x 16)	EKZE160ELL681MJ16S	Nippon Chemi-Con
7	1	C6	220 μ F, 16 V, Electrolytic, Low ESR, 180 m Ω , (6.3 x 15)	ELXZ160ELL221MF15D	Nippon Chemi-Con
8	1	C7	10 μ F, 25 V, Electrolytic, Gen. Purpose, (5 x 12)	ECA-1EM100	Panasonic
9	1	C8	100 nF, 25 V, Ceramic, X7R, 0805	08053C104KAT2A	AVX
10	1	C9	1000 pF, \pm 5%, 50V, Ceramic, COG, NP0 0603	GRM1885C1H102JA01D	Murata
11	1	D1	100 V, 2 A, Schottky, SMD, SMB	SS2H10-E3/52T	Vishay
12	1	D2	1000 V, 1 A, Rectifier, DO-41	1N4007-E3/54	Vishay
13	2	D3 D4	DIODE, GEN PURP, 100 V, 150 mA, SOD123, SOD-123F	1N4148W RHG	Taiwan Semi
14	1	F1	1 A, 250 V, Slow, Long Time Lag, RST 1	RST 1	Belfuse
15	1	L1	1000 μ H, 0.21 A, 5.5 x 10.5 mm	SBC1-102-211	Tokin
16	1	L2	3.5 mm x 4.45 mm, 56 Ω at 100 MHz, #22 AWG hole, Ferrite Bead	2761001112	Fair-Rite
17	1	Q1	60 V, 115 mA, SOT23-3	2N7002-7-F	Diodes, Inc.
18	1	R2	RES, 120 Ω , 5%, 1/4 W, Thick Film, 1206	ERJ-8GEYJ121V	Panasonic
19	1	R3	RES, 100 k Ω , 5%, 1/4 W, Thick Film, 1206	ERJ-8GEYJ104V	Panasonic
20	1	R4	RES, 100 Ω , 5%, 1/4 W, Thick Film, 1206	ERJ-8GEYJ101V	Panasonic
21	1	R5	RES, 392 Ω , 1%, 1/8 W, Thick Film, 0805	ERJ-6ENF3920V	Panasonic
22	1	R6	RES, 2.00 k Ω , 1%, 1/8 W, Thick Film, 0805	ERJ-6ENF2001V	Panasonic
23	2	R7 R10	RES, 24 k Ω , 5%, 1/10 W, Thick Film, 0603	ERJ-3GEYJ243V	Panasonic
24	2	R8 R14	RES, 510 k Ω , 5%, 1/4 W, Carbon Film	CFR-25JB-510K	Yageo
25	1	R9	RES, 240 k Ω , 5%, 1/4 W, Thick Film, 1206	ERJ-8GEYJ244V	Panasonic
26	1	R11	RES, 100 k Ω , 5%, 1/8 W, Thick Film, 0805	ERJ-6GEYJ104V	Panasonic
27	1	R13	RES, 0 Ω , 5%, 1/8 W, Thick Film, 0805	ERJ-6GEY0R00V	Panasonic
28	1	R15	RES, 2.4 Ω , 5%, 1/10 W, Thick Film, 0603	ERJ-3GEYJ2R4V	Panasonic
29	1	RV1	300 VAC, 25 J, 7 mm, RADIAL	V300LA4P	Littlefuse
30	1	T1	Bobbin, EE13, Vertical, 10 pins Transformer	YW-538-02B PNK-33061	Yih-Hwa Premier Magnetics
31	1	U1	LinkSwitch-TNZ, SO8	LNK3306D	Power Integrations
32	1	U2	Optocoupler, 80 V, CTR 80-160%, 4-DIP	PS2501-1-H-A	Renesas
33	1	U3	Optocoupler, 35 V, CTR 300-600%, 4-DIP	LTV-817D	Liteon
34	1	VR2	11 V, 500 mW, 2%, DO-35	BZX79-B11,133	NXP Semi
35	1	VR3	DIODE, ZENER, 7.5V, \pm 5%, 500 mW, SOD123, 150°C	MMSZ4693T1G	ON Semi
36	1	VR4	5.1 V, 5%, 500 mW, SOD-123, -55 C ~ +150 C	MMSZ4689T1G	ON Semi
37	1	VR5	DIODE ZENER 6.2 V 500 mW SOD123	MMSZ5234B-7-F	Diodes, Inc.

Mechanical Parts

Item	Qty	Ref Des	Description	Mfg Part Number	Mfg
1	1	L	Test Point, WHT, THRU-HOLE MOUNT	5012	Keystone
2	1	N	Test Point, BLK, THRU-HOLE MOUNT	5011	Keystone
3	1	+12V	Test Point, RED, Miniature THRU-HOLE MOUNT	5000	Keystone
4	1	ZCD	Test Point, BLUE, Miniature THRU-HOLE MOUNT	5117	Keystone
5	2	RTN RTN_ZCD	Test Point, BLK, Miniature THRU-HOLE MOUNT	5001	Keystone



7 Transformer Specification

7.1 Electrical Diagram

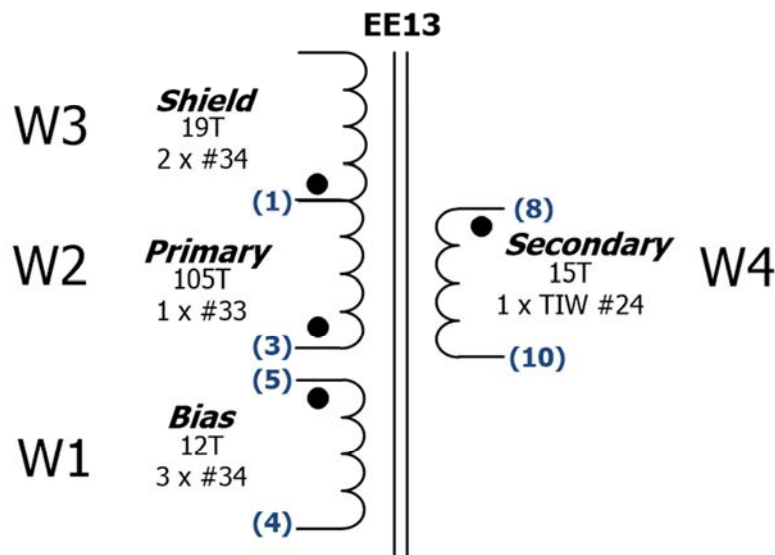

Figure 6 – Transformer Electrical Diagram.

7.2 Electrical Specifications

Parameter	Condition	Spec.
Nominal Primary Inductance	Measured at 1 V _{PK-PK} , 100 kHz switching frequency, between pin 1 and pin 3 with all other windings open.	1132 μH
Tolerance	Tolerance of Primary Inductance.	±5%
Leakage Inductance	Measured across primary winding with all other windings shorted.	<60 μH

7.3 Material List

Item	Description
[1]	Core: EE13 TP4A.
[2]	Bobbin: EE13, Vertical, 10 Pins. PI#: 25-00872-00.
[3]	Magnet Wire: #34 AWG.
[4]	Magnet Wire: #33 AWG.
[5]	Tripe Insulated Wire: #24 AWG.
[6]	Polyester Tape: 8 mm.
[7]	Polyester Tape: 5.5 mm.
[8]	Varnish: Dolph BC 359 or Equivalent.

7.4 Transformer Build Diagram

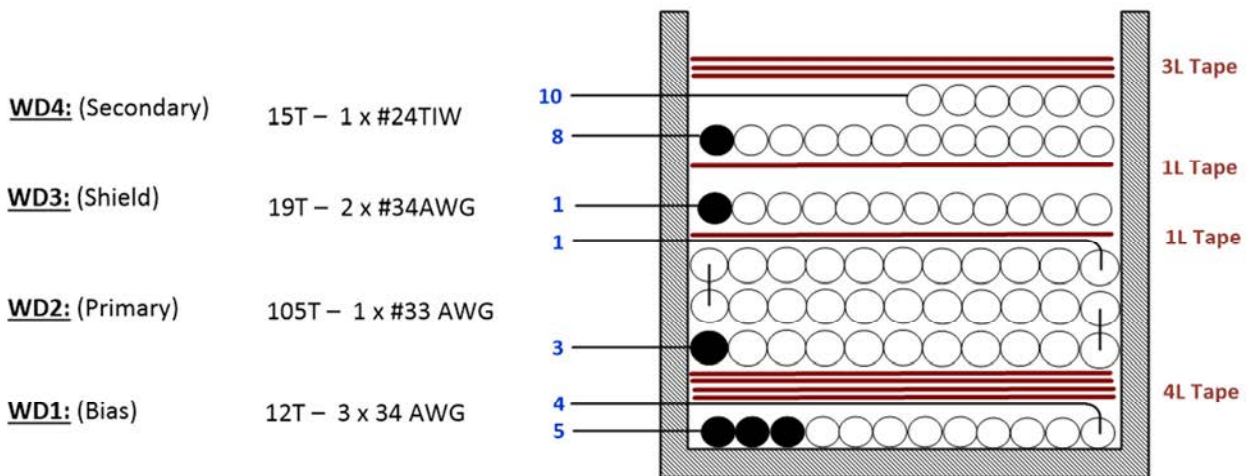
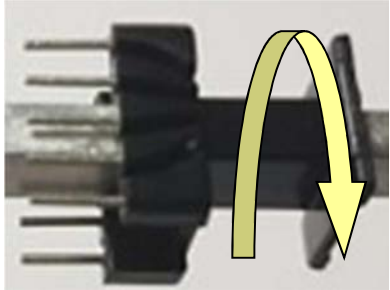
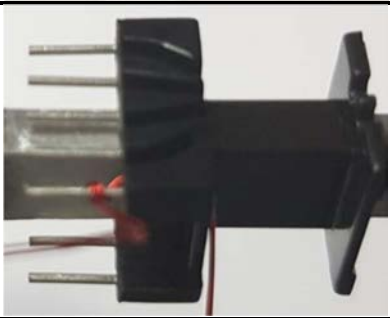
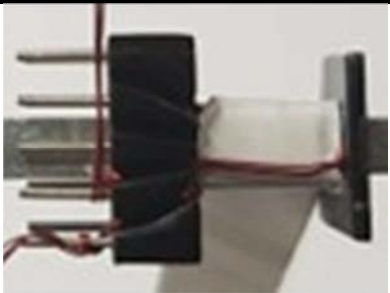
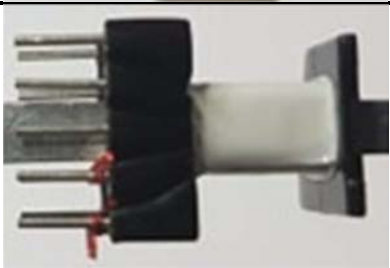
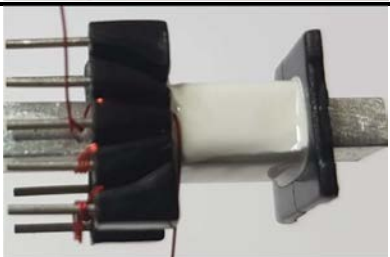

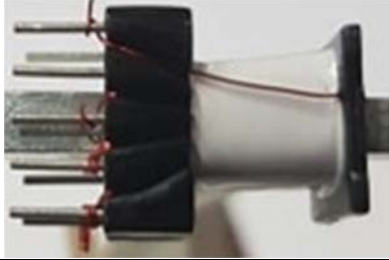
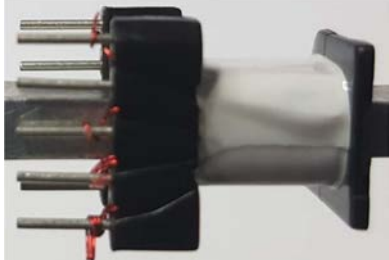
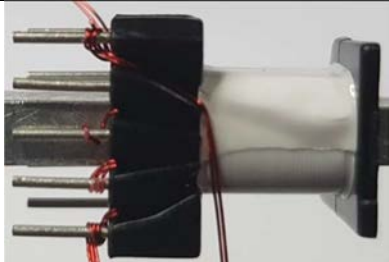
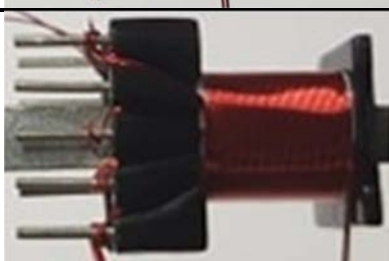
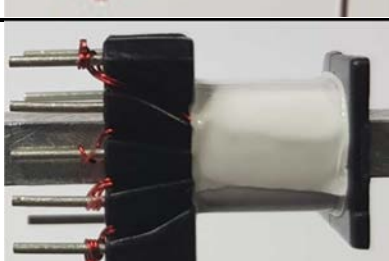

Figure 7 – Transformer Build Diagram.

7.5 Transformer Instructions

Winding Preparation	Place the bobbin Item [2] with the pins facing the winder. Winding direction is counter-clockwise.
W1 Bias	Start at pin 5. Wind 12T of 3 strands of wire Item [3] in one layer. Return to pin 4.
Insulation	Place four layers of tape Item [6] for insulation.
W2 Primary	Start at pin 3. Wind 105T of wire Item [4] in three layers. Return to pin 1.
Insulation	Place 1 layer of tape Item [6].
W3 Shield	Start at pin 1. Wind 19T of 2 strands of wire Item [3] in one layer. Cut off the wire at the end with no connection.
Insulation	Place 1 layer of tape Item [6].
W4 Secondary	Start at pin 8. Wind 15T of 1 strand of wire Item [5] in two layers. Return to pin 10.
Insulation	Place 3 layers of tape Item [6].
Assembly	Grind core Item [1] halves for specified primary inductance. Wrap core halves with tape Item [7]. Remove pins 2, 6, 7 and 9. Varnish with item Item [8].

7.6 **Transformer Winding Illustrations**

Winding Preparation		Place the bobbin Item [2] with the pins facing the winder. Winding direction is counter-clockwise.
W1 Bias		Start at pin 5. Wind 12T of 3 strands of wire Item [3] in one layer.
		Return to pin 4.
Insulation		Place four layers of tape Item [6] for insulation.
W2 Primary		Start at pin 3. Wind 105T of wire Item [4] in three layers.

		Return to pin 1.
Insulation		Place 1 layer of tape Item [6].
W3 Shield		Start at pin 1. Wind 19T of 2 strands of wire Item [3] in one layer.
		Cut off the wire at the right end with no connection.
Insulation		Place 1 layer of tape Item [6].
W4 Secondary		Start at pin 8. Wind 15T of 1 strand of wire Item [5] in two layers.

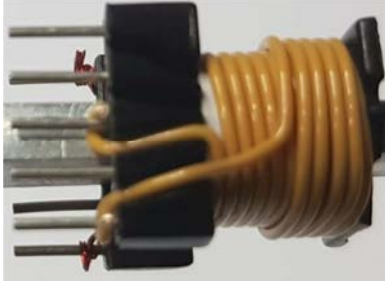
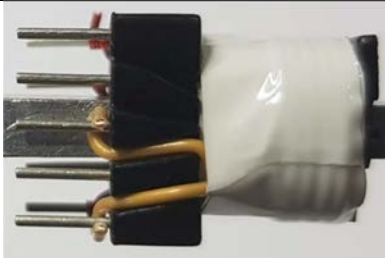
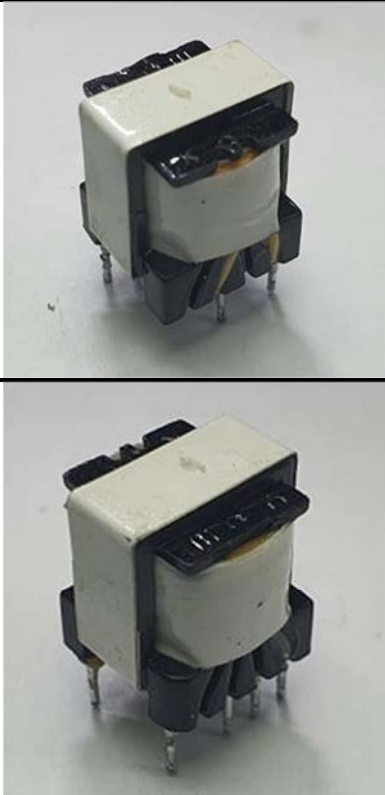

		<p>Return to pin 10.</p>
<p>Insulation</p>		<p>Place 3 layers of tape Item [6].</p>
<p>Assembly</p>		<p>Grind core Item [1] halves for specified primary inductance. Wrap core halves with tape Item [7]. Remove pins 2, 6, 7 and 9. Varnish with item Item [8].</p>

9 Transformer Design Spreadsheet

ACDC_LinkSwitch TNZ_Flyback_081 420; Rev.0.1; Copyright Power Integrations 2020	INPUT	INFO	OUTPUT	UNIT	ACDC LinkSwitch-TNZ Flyback Design Spreadsheet
ENTER APPLICATION VARIABLES					
LINE VOLTAGE RANGE			UNIVERSAL		AC line voltage range
VACMIN	90.00		90.00	V	Minimum AC line voltage
VACMAX	265.00		265.00	V	Maximum AC line voltage
fL			60.00	Hz	AC mains frequency
LINE RECTIFICATION TYPE	F		F		Line rectification type: select "F" if full wave rectification or "H" if half wave rectification
VOUT	12.00		12.00	V	Output voltage
IOUT	0.500		0.500	A	Average output current
EFFICIENCY (User Estimate)			0.80		Overall efficiency estimate. Adjust to match calculated or enter measured efficiency
LOSS ALLOCATION FACTOR			0.50		The ratio of power losses during the primary switch off-state to the total system losses
POUT			6.00	W	Continuous output power
CIN	16.80		16.80	uF	Input capacitor
VMIN			102.80	V	Valley voltage of the rectified minimum AC line voltage
VMAX			374.77	V	Peak voltage of the maximum AC line voltage
FEEDBACK	BIAS		BIAS		Type of feedback required. Choose "BIAS" for bias winding feedback and "OPTO" for an optocoupler feedback
BIAS WINDING	YES		YES		Select whether a bias winding is required or not
INPUT STAGE RESISTANCE	0.0		0.0	Ohms	Input stage resistance (includes thermistor, filtering components, etc)
PLOSS_INPUTSTAGE			0.000	W	Maximum input stage power loss
LINKSWITCH-TNZ VARIABLES					
CURRENT LIMIT MODE	STD		STD		Choose "STD" for Standard current limit or "RED" for reduced current limit
PACKAGE			SO-8C		Device package
DEVICE SERIES	LNK3306		LNK3306		Generic LinkSwitch-TNZ device
DEVICE CODE			LNK3306D		Required LinkSwitch-TNZ device
ILIMITMIN			0.450	A	Minimum current limit of the device
ILIMITTYP			0.482	A	Typical current limit of the device
ILIMITMAX			0.515	A	Maximum current limit of the device
RDSON			12.9	Ohms	Switch on-state drain-to-source resistance at 100 degC
FSMIN			62000	Hz	Minimum switching frequency
FSTYP			66000	Hz	Typical switching frequency
FSMAX			70000	Hz	Maximum switching frequency
BVDSS			725	V	Device breakdown voltage
PRIMARY WAVEFORM PARAMETERS					
OPERATION MODE			DCM		Discontinuous mode of operation
VOR	88.5		88.5	V	Voltage reflected across the primary winding when the primary switch is off
VDSON			2.00	V	Primary switch on-time drain-to-source voltage
VDSOFF			533.3	V	Primary switch off-time drain-to-source voltage stress
KRP/KDP			1.770		Degree on how much the operation tend to be continuous or discontinuous
KP_TRANSIENT			0.632		KP value under transient conditions



DUTY			0.332		Maximum duty cycle
TIME_ON_MIN			1.383	us	Primary switch minimum on-time
IPEAK_PRIMARY			0.581	A	Maximum primary peak current
IPED_PRIMARY			0.000	A	Maximum primary pedestal current
IAVG_PRIMARY			0.074	A	Maximum primary average current
IRMS_PRIMARY			0.160	A	Maximum root-mean-squared value of the primary current
PLOSS_SWITCH			0.452	W	Maximum primary switch power loss
THERMAL RESISTANCE OF SWITCH			100	degC/W	Net thermal resistance of primary switch
T_RISE_SWITCH			45.2	degC	Maximum temperature rise of the switch in degrees Celsius
LPRIMARY_MIN			1075	uH	Minimum primary inductance
LPRIMARY_TYP			1132	uH	Typical primary inductance
LPRIMARY_MAX			1188	uH	Maximum primary inductance
LPRIMARY_TOL	5		5	%	Primary inductance tolerance
SECONDARY WAVEFORM PARAMETERS					
IPEAK_SECONDARY			4.067	A	Peak secondary current
IRMS_SECONDARY			1.268	A	Maximum root-mean-squared value of the secondary current
IRIPPLE_SECONDARY			4.067	A	Maximum ripple value of the secondary current
PIV_SECONDARY			65.3	V	Peak inverse voltage of the secondary diode
VF_SECONDARY			0.70	V	Forward voltage drop of the secondary diode
TRANSFORMER CONSTRUCTION PARAMETERS					
Core Selection					
CORE	EE13		EE13		Select the transformer core
BOBBIN			B-EE13-H		Select the bobbin
AE			17.10	mm ²	Cross-sectional area of the core
LE			30.20	mm	Effective magnetic path length of the core
AL			1130.0	nH/(T ²)	Ungapped effective inductance of the core
VE			517.0	mm ³	Effective volume of the core
AW			21.90	mm ²	Window area of the bobbin
BW			7.40	mm	Width of the bobbin
MLT			23.60	mm	Mean length per turn of the bobbin
MARGIN			0.00	mm	Safety margin
Primary Winding					
NPRIMARY			105	turns	Primary winding number of turns
BMAX		Info	3788	Gauss	The target magnetic flux density of 1500 Gauss has been exceeded. Increase the number of turns in secondary
BAC			1894	Gauss	AC flux density
ALG			103	nH/(T ²)	Gapped core effective inductance
LG			0.190	mm	Core gap length
LAYERS_PRIMARY			3	layers	Number of primary winding layers
AWG_PRIMARY			34		Primary winding wire size in AWG
OD_PRIMARY_INSULATED			0.196	mm	Primary winding wire outer diameter with insulation
OD_PRIMARY_BARE			0.160	mm	Primary winding wire outer diameter without insulation
CMA_PRIMARY			249	mil ² /A	Primary winding wire CMA
Secondary Winding					
NSECONDARY	15		15	turns	Secondary winding number of turns
AWG_SECONDARY			26		Secondary winding wire size in AWG
OD_SECONDARY_INSULATED			0.709	mm	Secondary winding wire outer diameter with insulation
OD_SECONDARY_BARE			0.405	mm	Secondary winding wire outer diameter



RE					without insulation
CMA_SECONDARY			200	mil^2/A	Secondary winding wire CMA
Bias Winding					
NBIAS			15	turns	Bias winding number of turns
VF_BIAS			0.70	V	Forward voltage drop of bias diode
VBIAS			12.00	V	Voltage across the bias winding
PIV_BIAS			65.25	V	Peak inverse voltage on the bias diode
RBP			84500	Ohms	BP pin resistor
CBP			0.1	uF	BP pin capacitor
Primary Winding Losses					
PLOSS_PRIMARYWINDING			0.054	W	Maximum power loss dissipated in the primary winding
FEEDBACK PARAMETERS					
DIODE_BIAS			1N4003-4007		Recommended bias diode is 1N400X
RUPPER			15000	Ohms	Resistor divider component between bias winding and FB pin of LinkSwitch-TNZ
RLOWER			3000	Ohms	Resistor divider component between FB pin of LinkSwitch-TNZ and primary RTN
OUTPUT PARAMETERS					
VOUT1			12.00	V	Output voltage 1
IOUT1			0.500	A	Output current 1
POUT1			6.00	W	Output power 1
VD1			0.70	V	Forward voltage drop of secondary diode for output 1
NS1			15	turns	Number of turns for output 1
ISPEAK1			4.07	A	Instantaneous peak value of the secondary current for output 1
ISRMS1			1.268	A	Root-mean-squared value of the secondary current for output 1
ISRIPPLE1			4.067	A	Current ripple on the secondary current waveform for output 1
PIV1_CALCULATED			65.3	V	Computed peak inverse voltage stress on the secondary diode for output 1
PIV1_RATING			100	V	Peak inverse voltage rating on the secondary diode for output 1
TRR1			25	ns	Reverse recovery time of the secondary diode for output 1
IFM1			1.30	A	Maximum forward continuous current of the secondary diode for output 1
DIODE1_RECOMMENDED			BYV27-100		Recommended diode for output 1
PLOSS_DIODE1			0.273	W	Maximum secondary diode power loss for output 1
VOUT1_RIPPLE			120	mV	Output voltage ripple for output 1
ESR_COUT1			30	mOhms	Equivalent series resistance of the output capacitor for output 1
IRMS_COUT1			1.165	A	Root-mean-squared value of the output capacitor current for output 1
PLOSS_COUT1			0.041	W	Maximum output capacitor power loss for output 1
CMS1			254	Cmils	Bare conductor effective area in circular mils for output 1
AWGS1			26	AWG	Wire size of winding for output 1
ODS1_INSULATED			0.709	mm	Secondary winding wire outer diameter with insulation for output 1
ODS1_BARE			0.405	mm	Secondary winding wire outer diameter without insulation for output 1
PLOSS_SECONDARYWINDING1			0.076	W	Maximum power loss dissipated of secondary winding for output 1



10 Performance Data

10.1 Efficiency

10.1.1 Active Mode Measurement Data

Measured Performance			Standards			
		V _{IN} (VAC)		DOE6	EC CoC (v5)	
		115	230		2014 Tier 1	2016 Tier 2
			Efficiency (%)			
Load (%)	10	74.76	74.70		65.82	69.03
	25	77.69	77.86			
	50	79.97	80.17			
	75	80.67	80.96			
	100	80.87	81.29			
	Ave	79.80	80.07	78.88	75.82	79.03
No-Load Input Power (mW)		19.17	21.67	100	150	75
			Compliant	Y	Y	Y

10.1.2 Full Load Efficiency vs. Line

Test Condition: Soak for 15 minutes for each line.

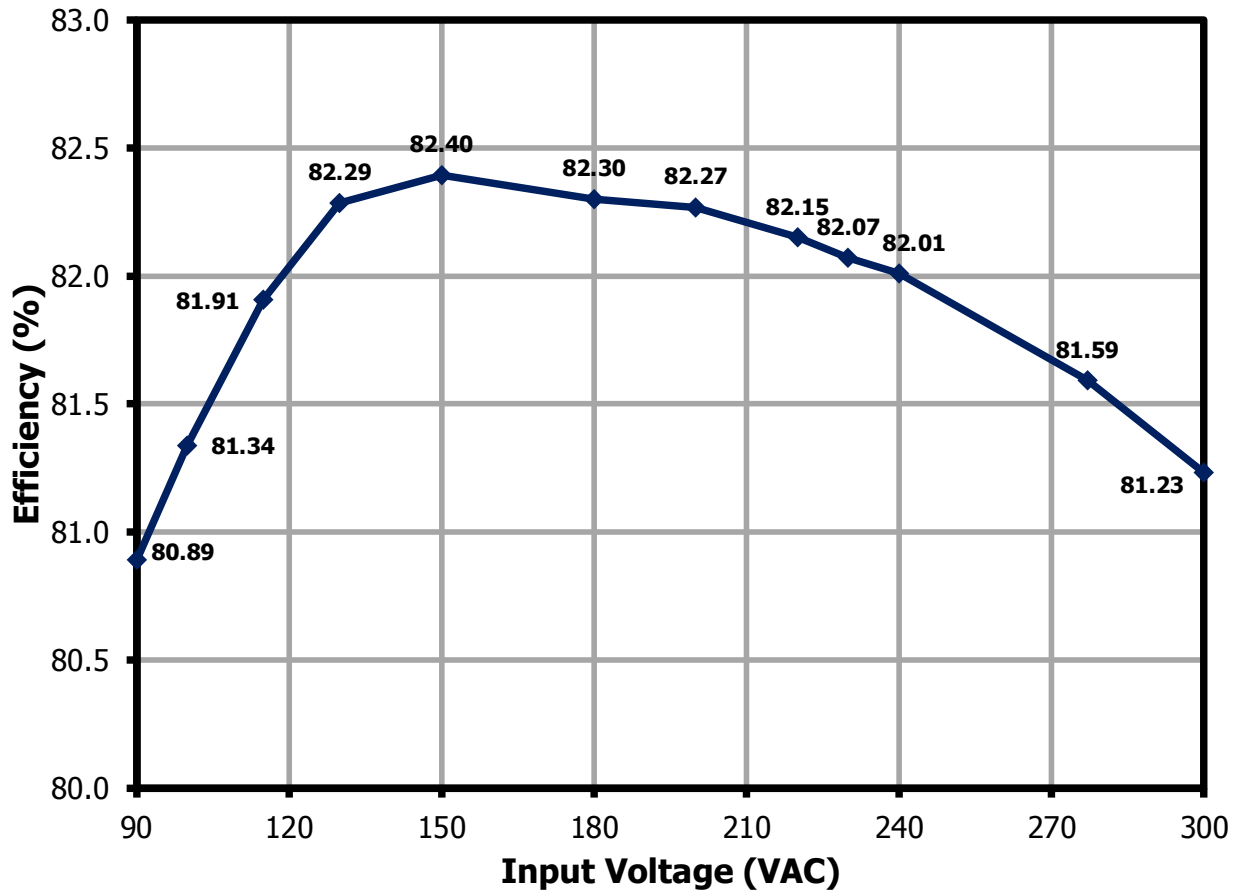

Figure 8 – Full Load Efficiency vs. Line.

10.1.3 Efficiency vs. Load

Test Condition: Soak for 15 minutes each line, and 5 minutes for each load.

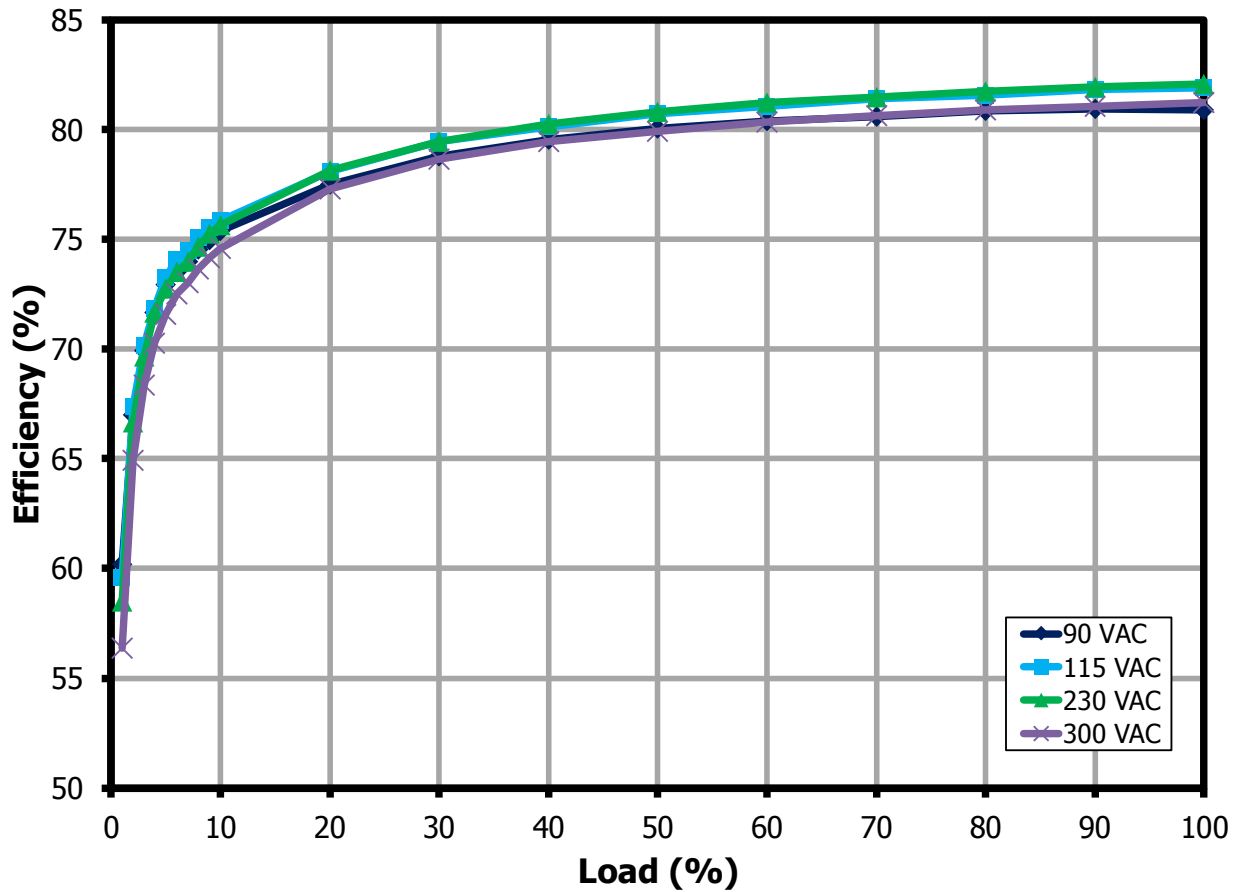

Figure 9 – Efficiency vs. Percentage Load.

10.2 Available Standby Output Power

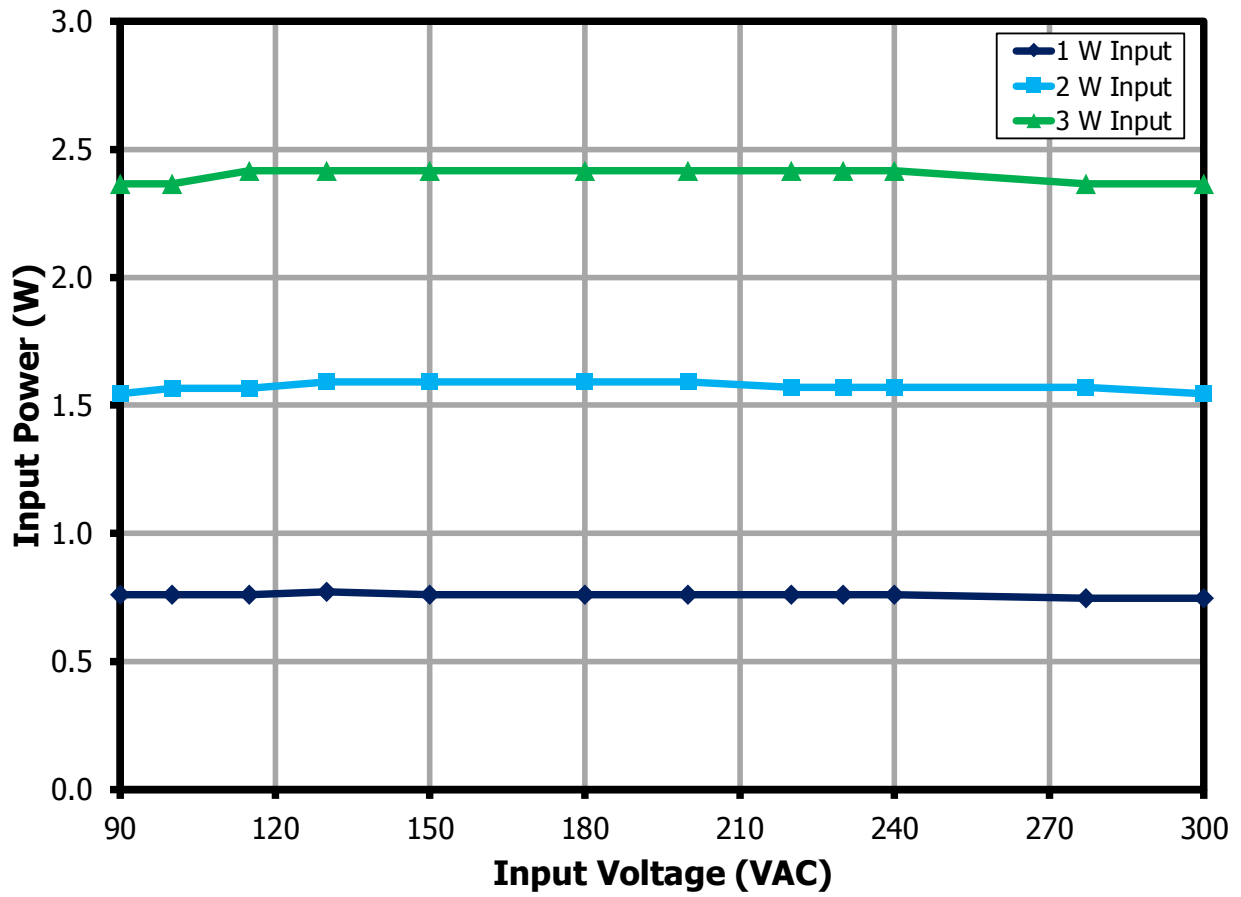

Figure 10 – Available Standby Output Power for 1 W, 2 W and 3 W Input Power.

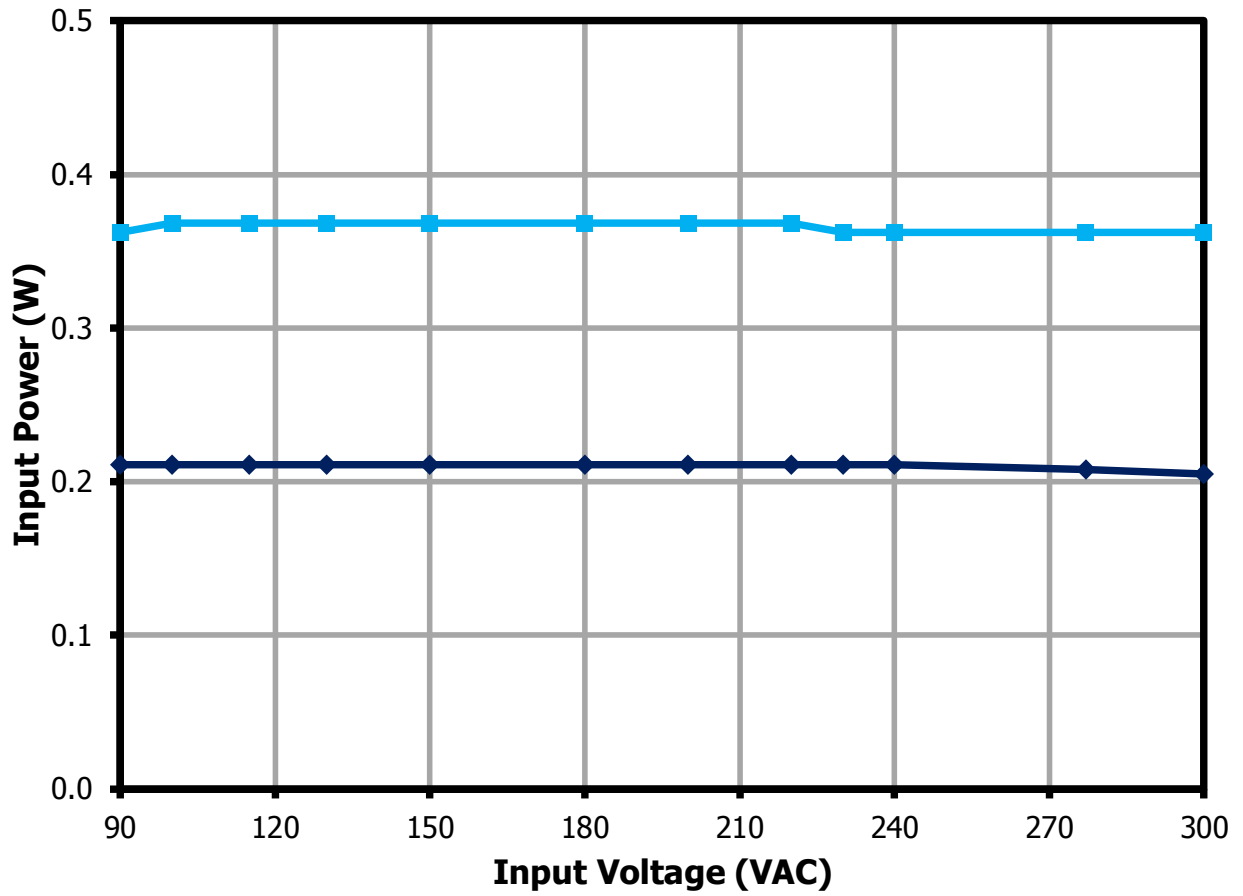

Figure 11 – Available Standby Output Power for 0.3 W and 0.5 W Input Power.

10.3 *No-Load Input Power*

Test Condition: Soak for 15 minutes each line and 1 minute integration time.

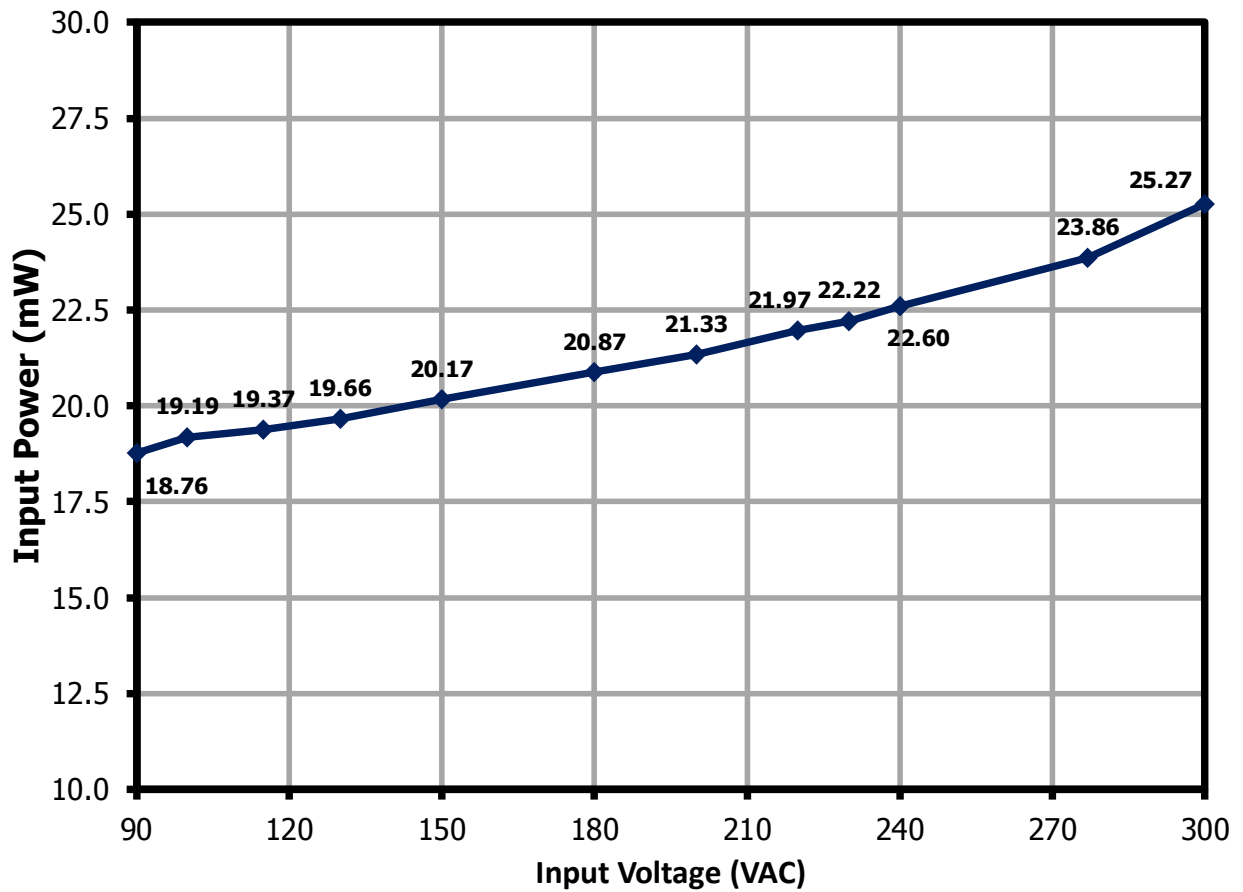

Figure 12 – No-Load Input Power vs. Line at Room Temperature.

10.4 *Line Regulation*

Test Condition: Soak for 15 minutes for each line.

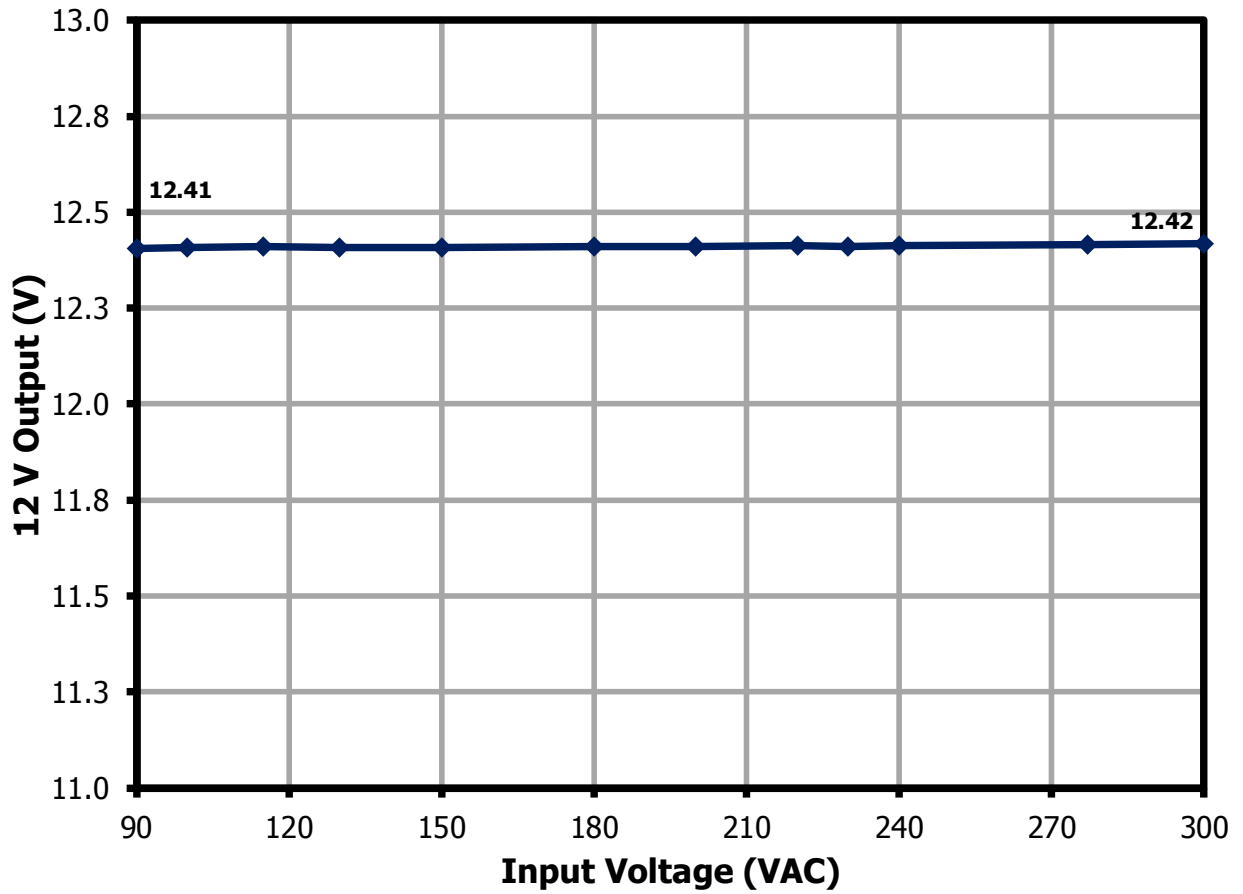

Figure 13 – Output Voltage vs. Line Voltage.

10.5 Load Regulation

Test Condition: Soak for 15 minutes each line, and 5 minutes for each load.

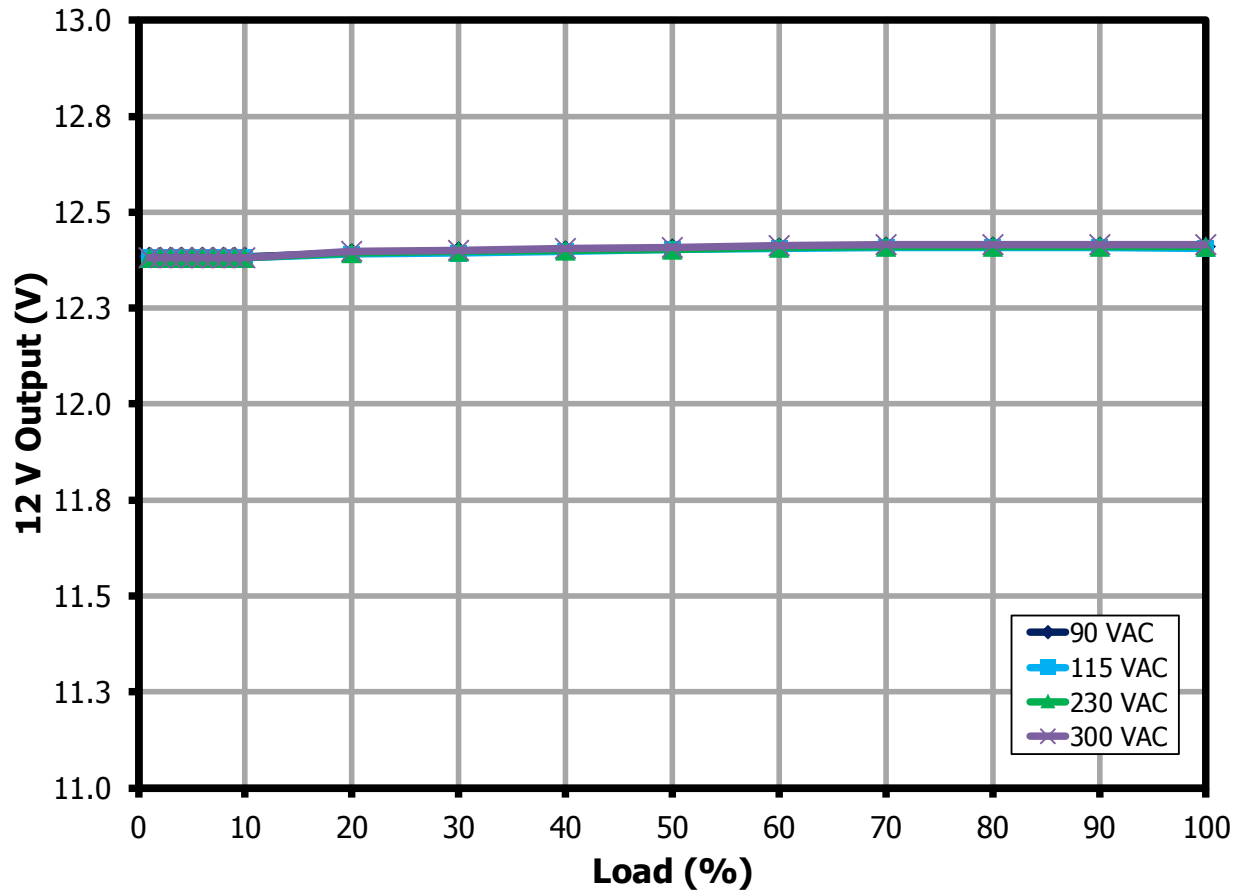

Figure 14 – Output Voltage vs. Percent Load.

11 Waveforms

11.1 Zero Crossing Detection

11.1.1 Zero Crossing Detection at Normal Operation

11.1.1.1 100% Load

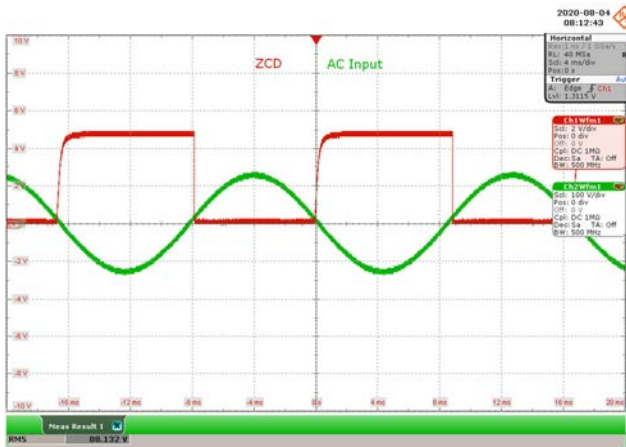

Figure 15 – 90 VAC 60 Hz.

CH1: ZCD, 2 V / div., 4 ms / div.
CH2: V_{IN} , 100 V / div., 4 ms / div.

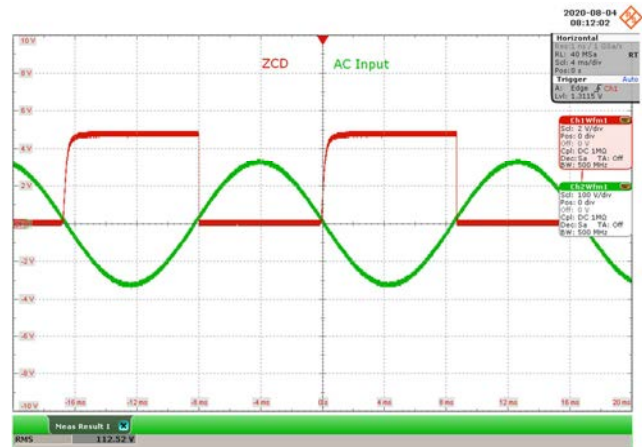

Figure 16 – 115 VAC 60 Hz.

CH1: ZCD, 2 V / div., 4 ms / div.
CH2: V_{IN} , 100 V / div., 4 ms / div.

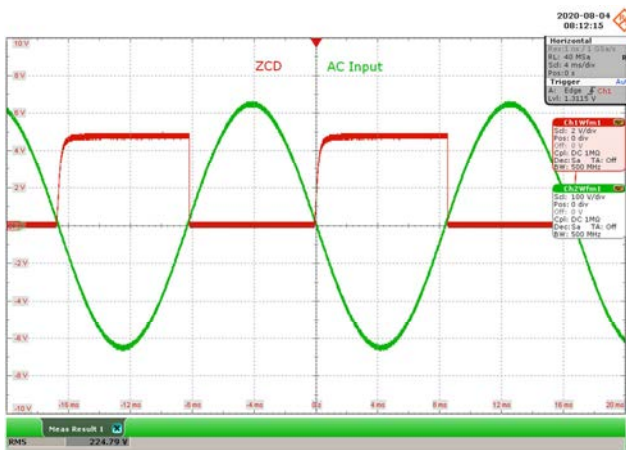

Figure 17 – 230 VAC 50 Hz.

CH1: ZCD, 2 V / div., 4 ms / div.
CH2: V_{IN} , 100 V / div., 4 ms / div.

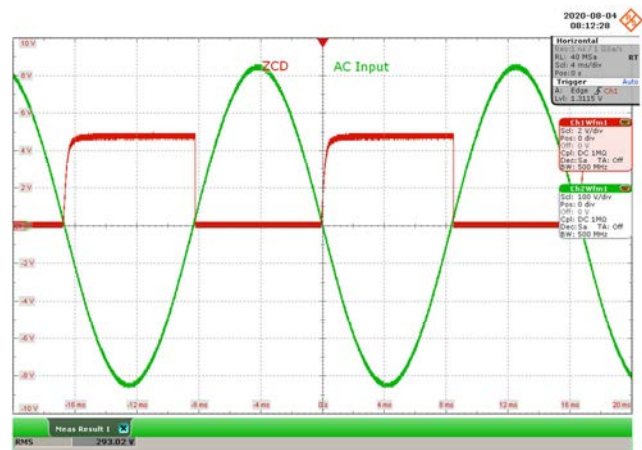

Figure 18 – 300 VAC 50 Hz.

CH1: ZCD, 2 V / div., 4 ms / div.
CH2: V_{IN} , 100 V / div., 4 ms / div.

11.1.1.2 0% Load

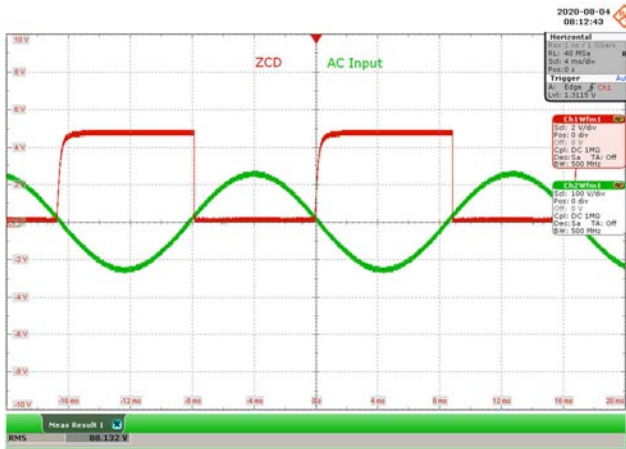

Figure 19 – 90 VAC 60 Hz.
 CH1: ZCD, 2 V / div., 4 ms / div.
 CH2: V_{IN} , 100 V / div., 4 ms / div.

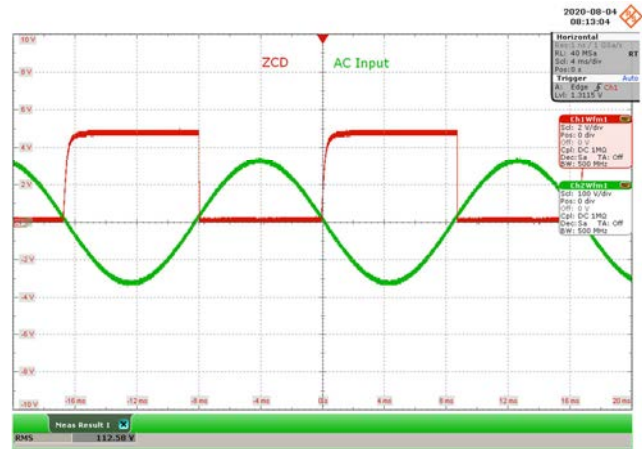

Figure 20 – 115 VAC 60 Hz.
 CH1: ZCD, 2 V / div., 4 ms / div.
 CH2: V_{IN} , 100 V / div., 4 ms / div.

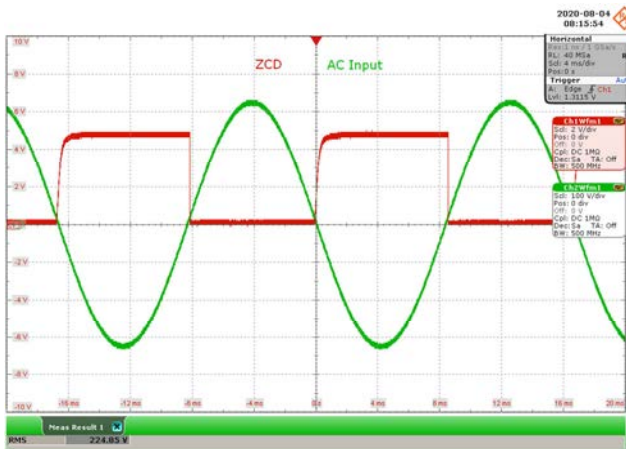

Figure 21 – 230 VAC 50 Hz.
 CH1: ZCD, 2 V / div., 4 ms / div.
 CH2: V_{IN} , 100 V / div., 4 ms / div.

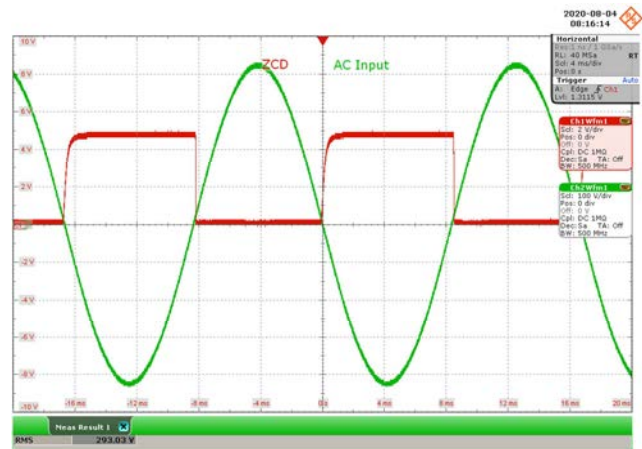

Figure 22 – 300 VAC 50 Hz.
 CH1: ZCD, 2 V / div., 4 ms / div.
 CH2: V_{IN} , 100 V / div., 4 ms / div.

11.1.2 Zero Crossing Detection at Start-up

11.1.2.1 0° Start-up Phase

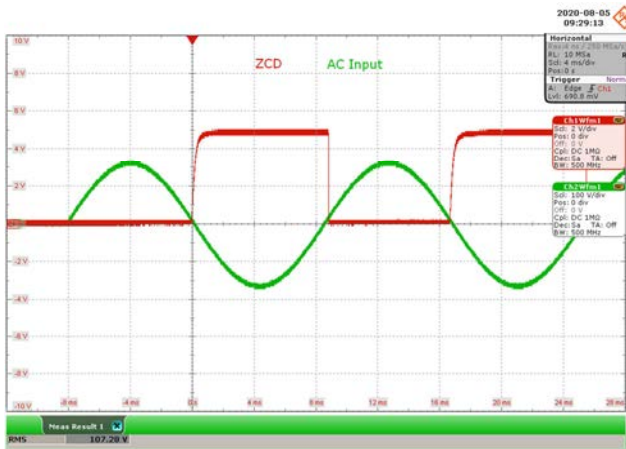

Figure 23 – 115 VAC 60 Hz, No Load
 CH1: ZCD, 2 V / div., 4 ms / div.
 CH2: V_{IN} , 100 V / div., 4 ms / div.

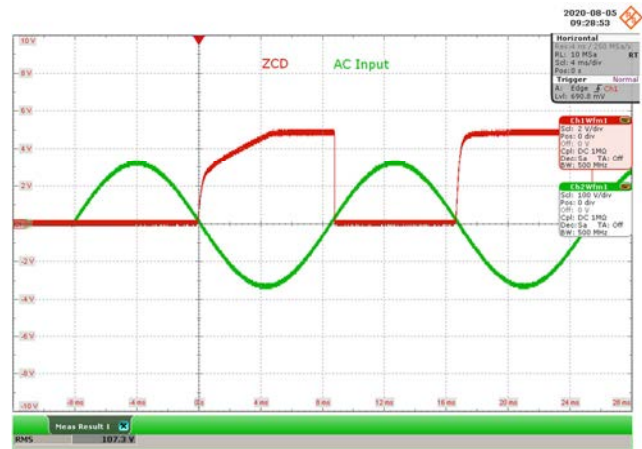

Figure 24 – 115 VAC 60 Hz, Full Load
 CH1: ZCD, 2 V / div., 4 ms / div.
 CH2: V_{IN} , 100 V / div., 4 ms / div.

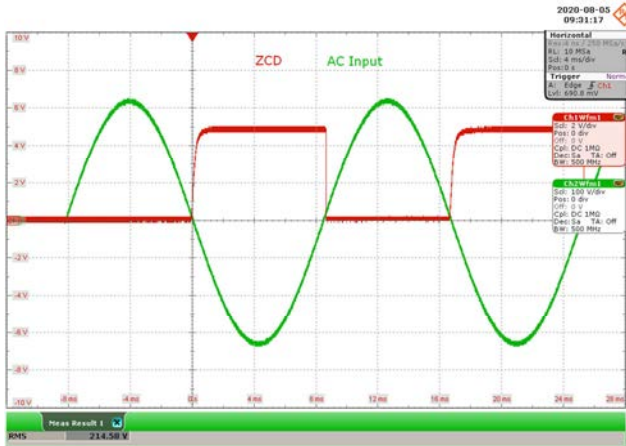

Figure 25 – 230 VAC 50 Hz, No Load
 CH1: ZCD, 2 V / div., 4 ms / div.
 CH2: V_{IN} , 100 V / div., 4 ms / div.

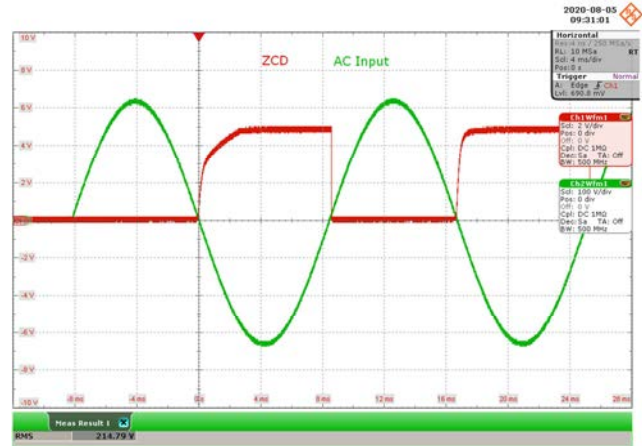

Figure 26 – 230 VAC 50 Hz, Full Load
 CH1: ZCD, 2 V / div., 4 ms / div.
 CH2: V_{IN} , 100 V / div., 4 ms / div.

11.1.2.2 90° Start-up Phase

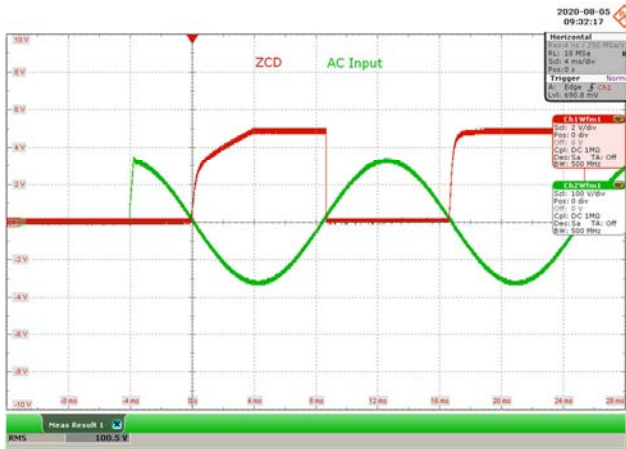

Figure 27 – 115 VAC 60 Hz, No Load
 CH1: ZCD, 2 V / div., 4 ms / div.
 CH2: V_{IN} , 100 V / div., 4 ms / div.

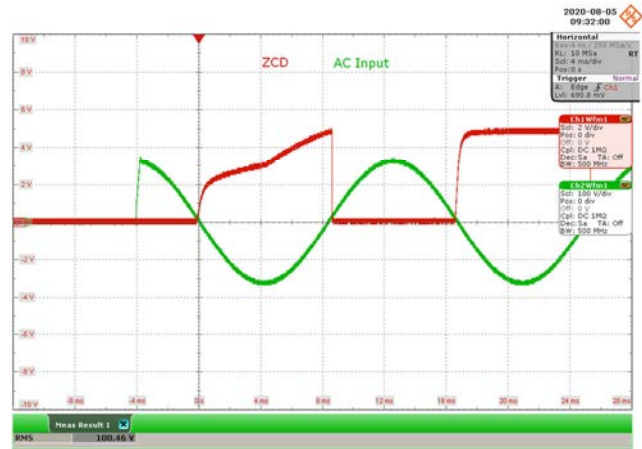

Figure 28 – 115 VAC 60 Hz, Full Load
 CH1: ZCD, 2 V / div., 4 ms / div.
 CH2: V_{IN} , 100 V / div., 4 ms / div.



Figure 29 – 230 VAC 50 Hz, No Load
 CH1: ZCD, 2 V / div., 4 ms / div.
 CH2: V_{IN} , 100 V / div., 4 ms / div.

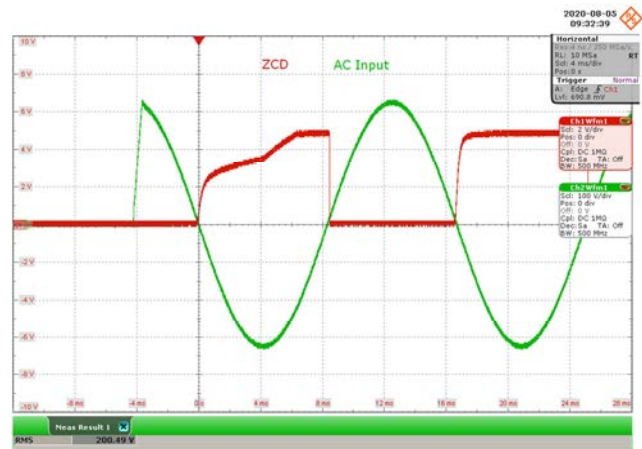

Figure 30 – 230 VAC 50 Hz, Full Load
 CH1: ZCD, 2 V / div., 4 ms / div.
 CH2: V_{IN} , 100 V / div., 4 ms / div.

11.1.3 Zero Crossing Detection Delay

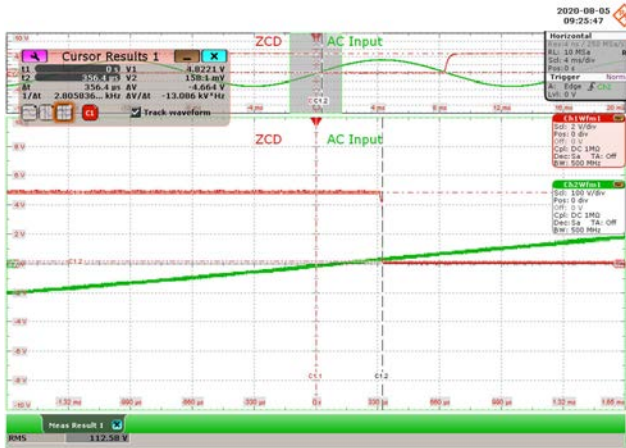

Figure 31 – 115 VAC 60 Hz, Full Load.
 CH1: ZCD, 2 V / div., 4 ms / div.
 CH2: V_{IN}, 100 V / div., 4 ms / div.
 Falling edge delay = 356.4 μs.

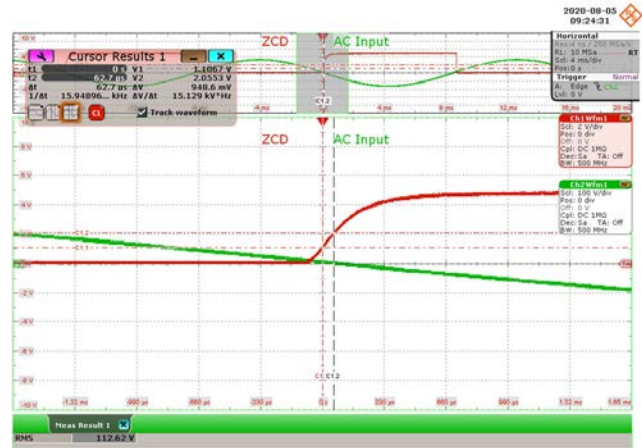

Figure 32 – 115 VAC 60 Hz, Full Load.
 CH1: ZCD, 2 V / div., 4 ms / div.
 CH2: V_{IN}, 100 V / div., 4 ms / div.
 Rising edge delay = 62.7 μs.

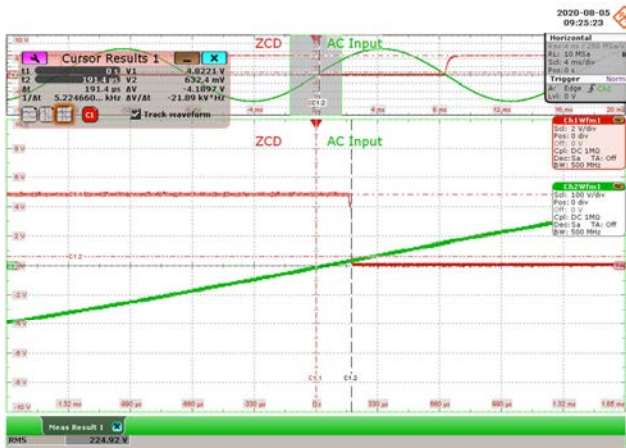

Figure 33 – 230 VAC 50 Hz, Full Load.
 CH1: ZCD, 2 V / div., 4 ms / div.
 CH2: V_{IN}, 100 V / div., 4 ms / div.
 Falling edge delay = 191.4 μs.

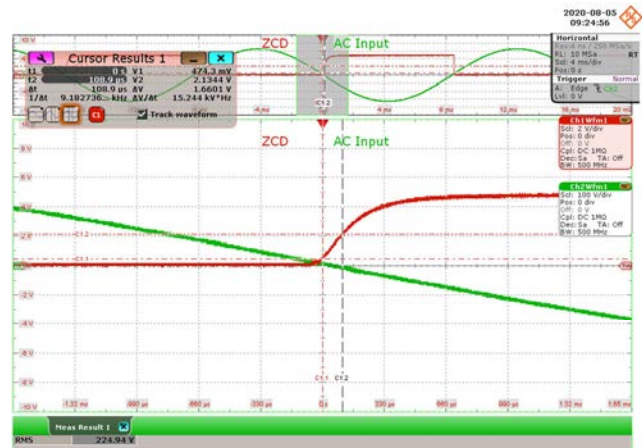

Figure 34 – 230 VAC 50 Hz, Full Load.
 CH1: ZCD, 2 V / div., 4 ms / div.
 CH2: V_{IN}, 100 V / div., 4 ms / div.
 Rising edge delay = 100.9 μs.

11.2 Zero Crossing Detection using NPN Solution

Test Condition: Q1=BC847, R9=10k Ω , R10=10k Ω , Remove VR3

11.2.1 Zero Crossing Detection at Normal Operation

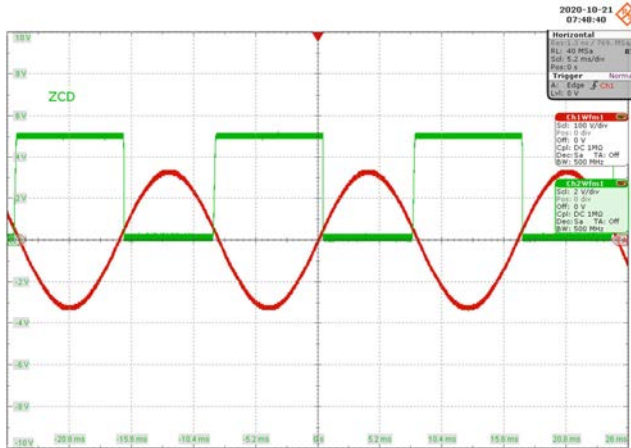

Figure 35 – 115 VAC 60 Hz, No-Load.

CH1: V_{IN}, 100 V / div., 5.2 ms / div.
CH2: ZCD, 2 V / div., 5.2 ms / div.

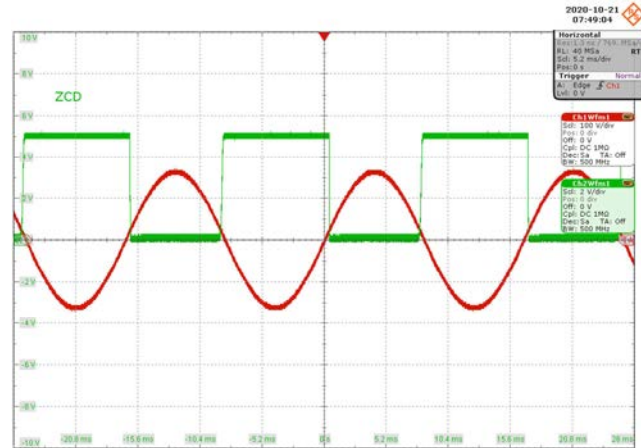

Figure 36 – 115 VAC 60 Hz, Full Load.

CH1: V_{IN}, 100 V / div., 5.2 ms / div.
CH2: ZCD, 2 V / div., 5.2 ms / div.

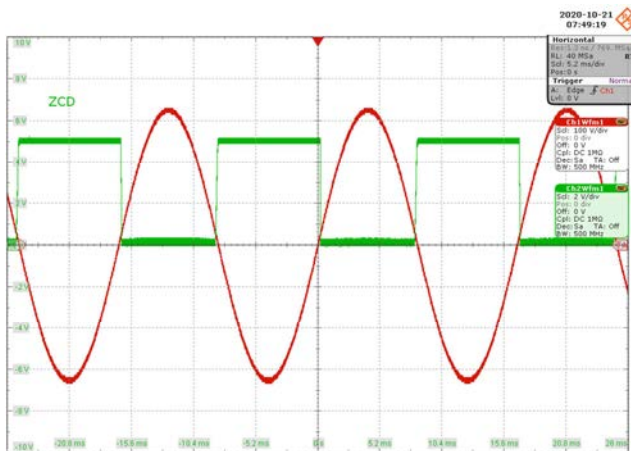

Figure 37 – 230 VAC 50 Hz, No-Load.

CH1: V_{IN}, 100 V / div., 5.2 ms / div.
CH2: ZCD, 2 V / div., 5.2 ms / div.

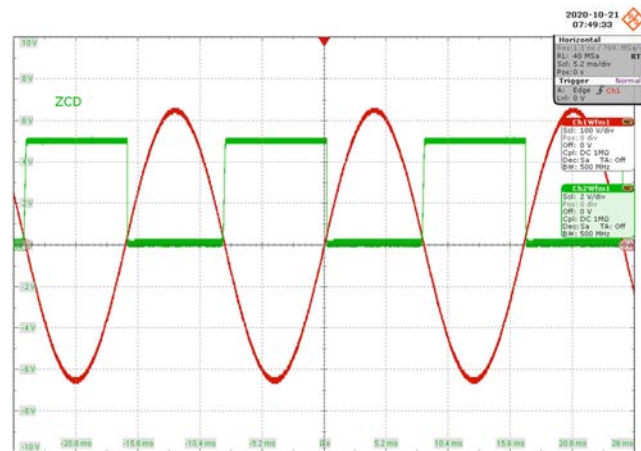

Figure 38 – 265 VAC 50 Hz, Full Load.

CH1: V_{IN}, 100 V / div., 5.2 ms / div.
CH2: ZCD, 2 V / div., 5.2 ms / div.

11.2.2 Zero Crossing Detection Delay

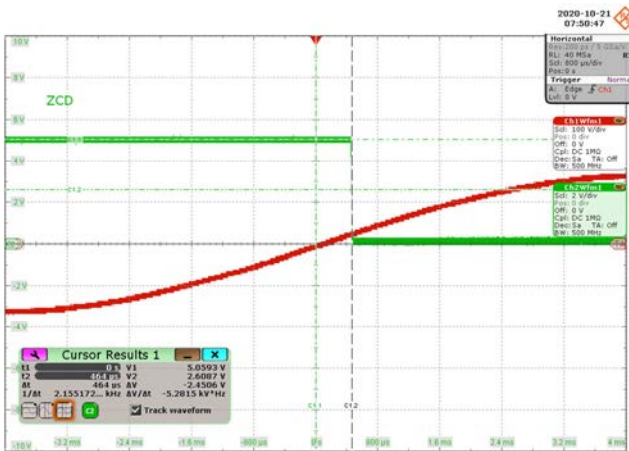

Figure 39 – 115 VAC 60 Hz.
 CH1: V_{IN}, 100 V / div., 800 μs / div.
 CH2: ZCD, 2 V / div., 800 μs / div.
 Falling edge delay = 464 μs.

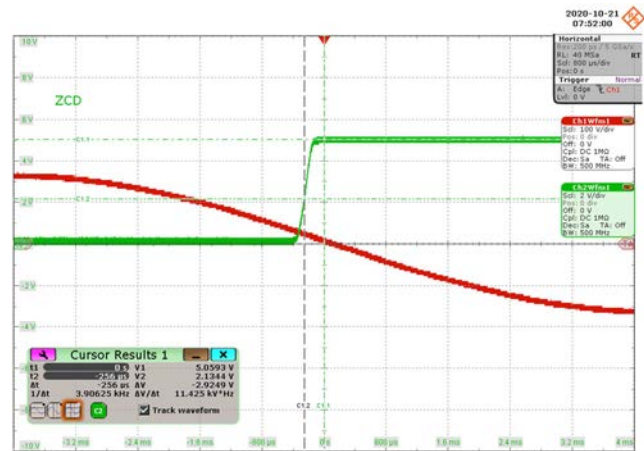

Figure 40 – 115 VAC 60 Hz.
 CH1: V_{IN}, 100 V / div., 800 μs / div.
 CH2: ZCD, 2 V / div., 800 μs / div.
 Rising edge delay = -256 μs.

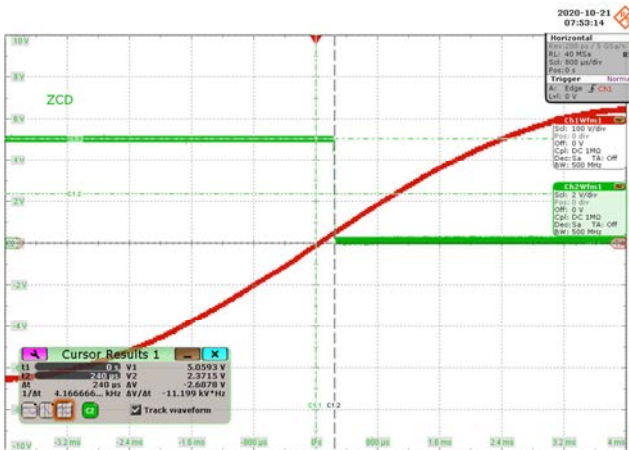

Figure 41 – 230 VAC 50 Hz.
 CH1: V_{IN}, 100 V / div., 800 μs / div.
 CH2: ZCD, 2 V / div., 800 μs / div.
 Falling edge delay = 240 μs.

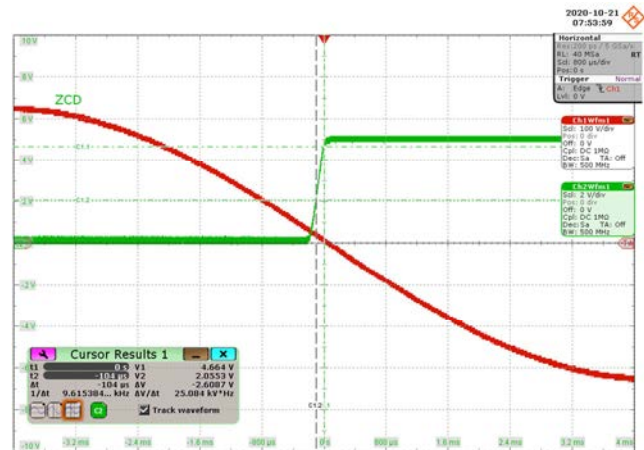

Figure 42 – 230 VAC 50 Hz.
 CH1: V_{IN}, 100 V / div., 800 μs / div.
 CH2: ZCD, 2 V / div., 800 μs / div.
 Falling edge delay = -104 μs.

11.3 Load Transient Response

Test Condition: Dynamic load frequency = 1 kHz, Duty cycle = 50 %

11.3.1 0% - 100% Load Change

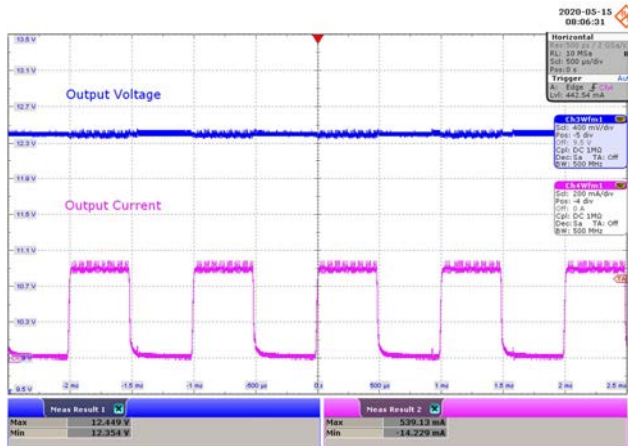

Figure 43 – 90 VAC 60 Hz.

CH3: V_{OUT} , 400 mV / div., 500 μ s / div.
 CH4: I_{OUT} , 200 mA / div., 500 μ s / div.
 V_{MAX} : 12.449 V, V_{MIN} : 12.354 V.

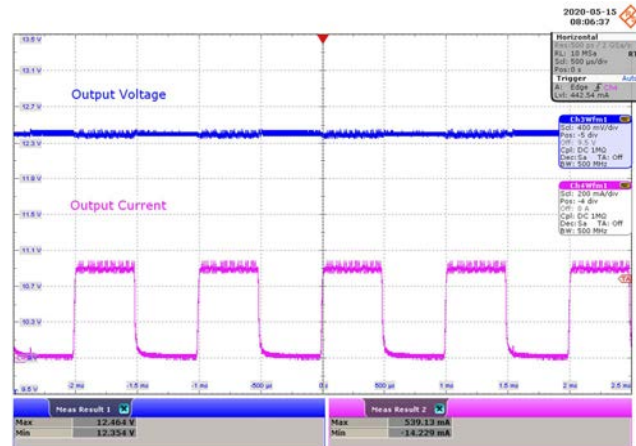

Figure 44 – 115 VAC 60 Hz.

CH3: V_{OUT} , 400 mV / div., 500 μ s / div.
 CH4: I_{OUT} , 200 mA / div., 500 μ s / div.
 V_{MAX} : 12.464 V, V_{MIN} : 12.354 V.

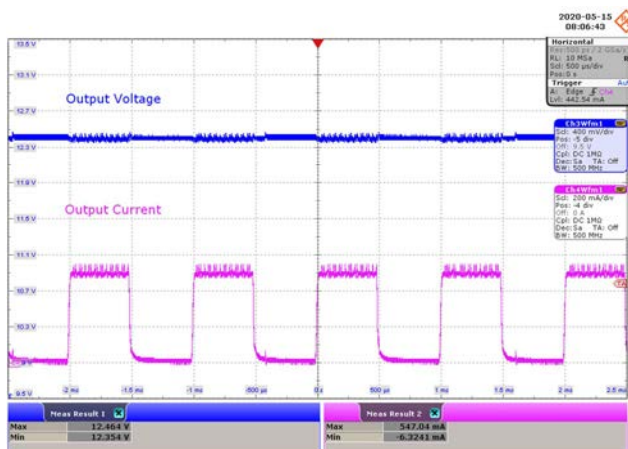

Figure 45 – 230 VAC 50 Hz.

CH3: V_{OUT} , 400 mV / div., 500 μ s / div.
 CH4: I_{OUT} , 200 mA / div., 500 μ s / div.
 V_{MAX} : 12.464 V, V_{MIN} : 12.354 V.

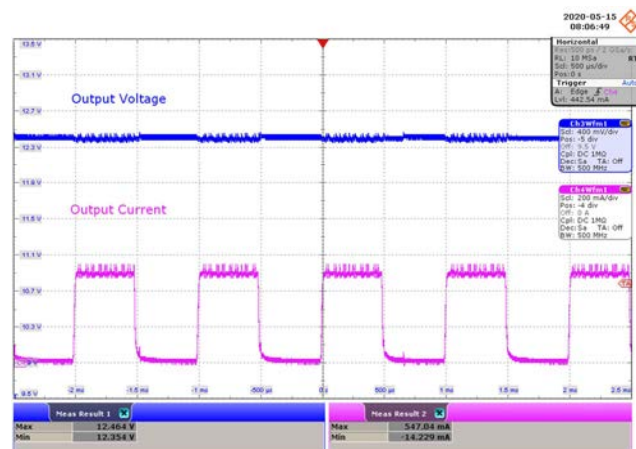

Figure 46 – 300 VAC 50 Hz.

CH3: V_{OUT} , 400 mV / div., 500 μ s / div.
 CH4: I_{OUT} , 200 mA / div., 500 μ s / div.
 V_{MAX} : 12.464 V, V_{MIN} : 12.354 V.

11.3.2 50% - 100% Load Change

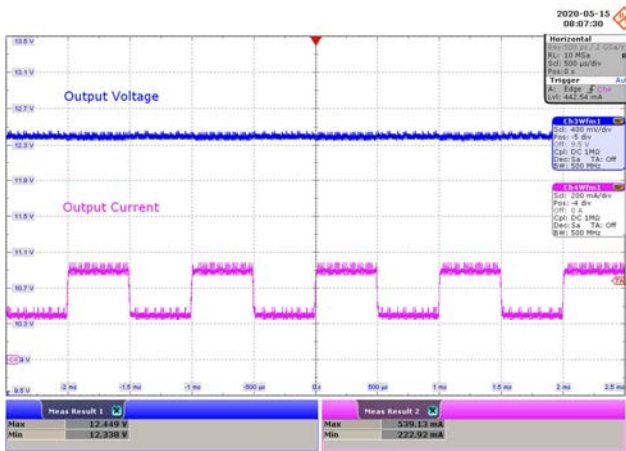

Figure 47 – 90 VAC 60 Hz.
 CH3: V_{OUT} , 400 mV / div., 500 μ s / div.
 CH4: I_{OUT} , 200 mA / div., 500 μ s / div.
 V_{MAX} : 12.449 V, V_{MIN} : 12.338 V.

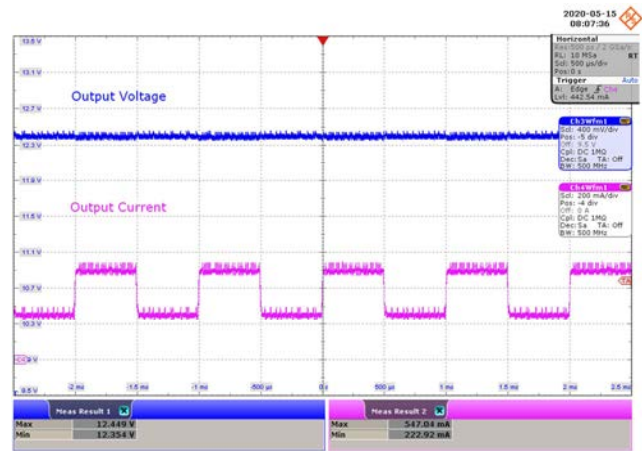

Figure 48 – 115 VAC 60 Hz.
 CH3: V_{OUT} , 400 mV / div., 500 μ s / div.
 CH4: I_{OUT} , 200 mA / div., 500 μ s / div.
 V_{MAX} : 12.449 V, V_{MIN} : 12.354 V.

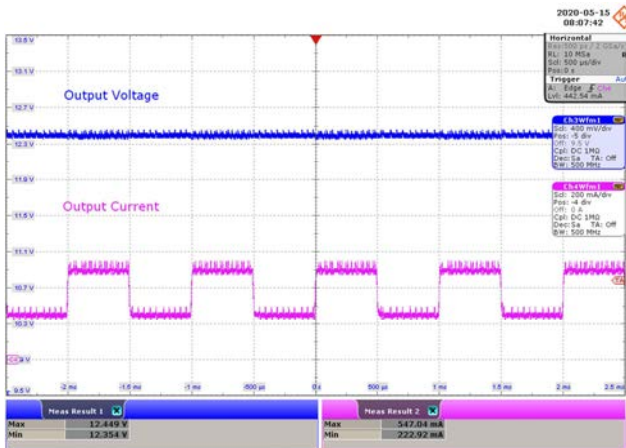

Figure 49 – 230 VAC 50 Hz.
 CH3: V_{OUT} , 400 mV / div., 500 μ s / div.
 CH4: I_{OUT} , 200 mA / div., 500 μ s / div.
 V_{MAX} : 12.449 V, V_{MIN} : 12.354 V.

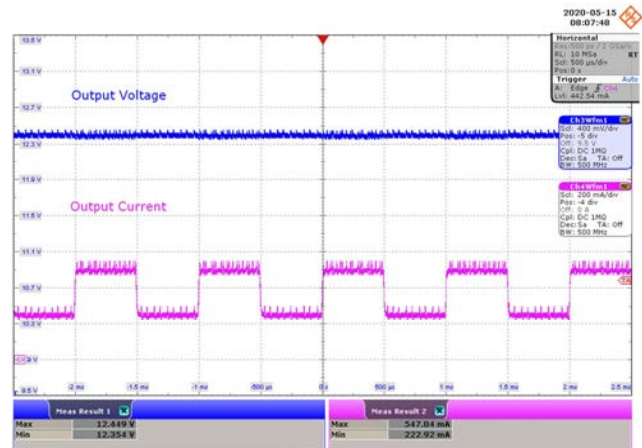

Figure 50 – 300 VAC 50 Hz.
 CH3: V_{OUT} , 400 mV / div., 500 μ s / div.
 CH4: I_{OUT} , 200 mA / div., 500 μ s / div.
 V_{MAX} : 12.449 V, V_{MIN} : 12.354 V.

11.4 Output Voltage at Start-up

11.4.1 CC Mode

11.4.1.1 100% Load

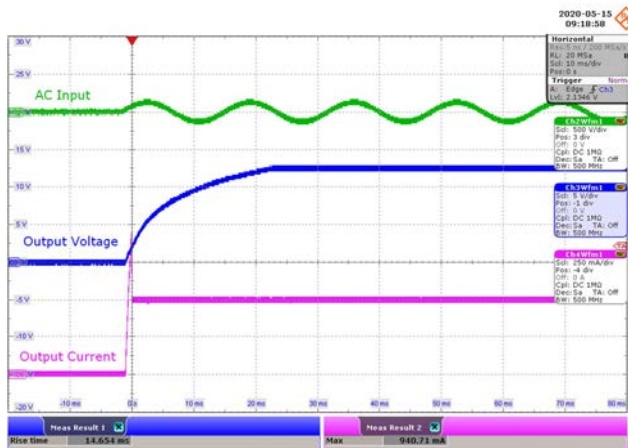

Figure 51 – 90 VAC 60 Hz.

CH2: V_{IN} , 500 V / div., 10 ms / div.
 CH3: V_{OUT} , 5 V / div., 10 ms / div.
 CH4: I_{OUT} , 250 mA / div., 10 ms / div.
 Rise Time = 14.654 ms.

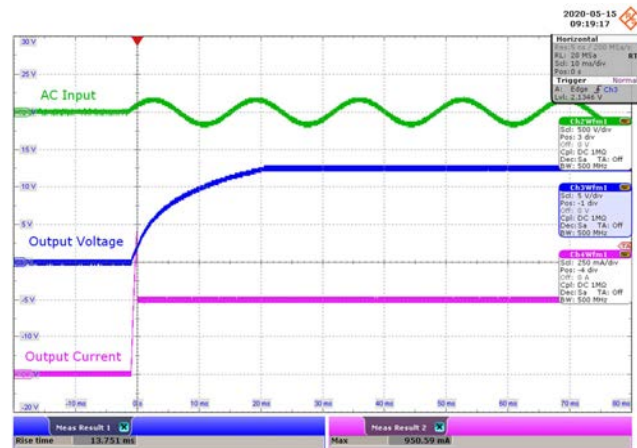

Figure 52 – 115 VAC 60 Hz.

CH2: V_{IN} , 500 V / div., 10 ms / div.
 CH3: V_{OUT} , 5 V / div., 10 ms / div.
 CH4: I_{OUT} , 250 mA / div., 10 ms / div.
 Rise Time = 13.751 ms.

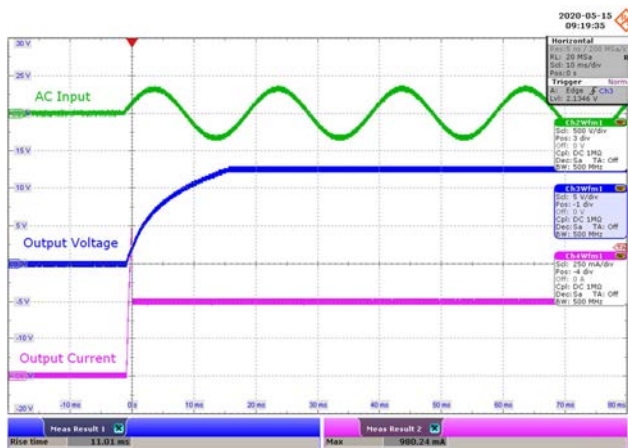

Figure 53 – 230 VAC 50 Hz.

CH2: V_{IN} , 500 V / div., 10 ms / div.
 CH3: V_{OUT} , 5 V / div., 10 ms / div.
 CH4: I_{OUT} , 250 mA / div., 10 ms / div.
 Rise Time = 11.01 ms.

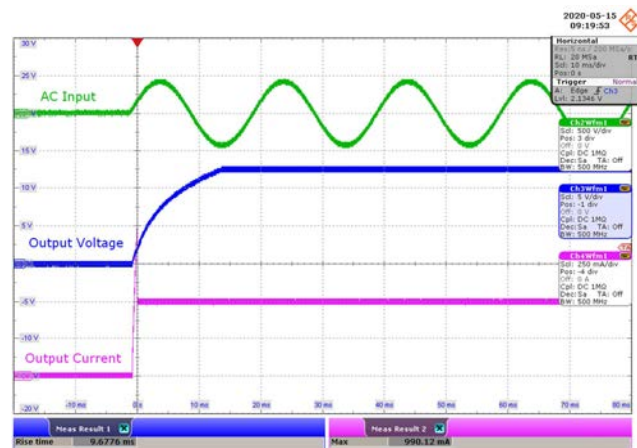

Figure 54 – 300 VAC 50 Hz.

CH2: V_{IN} , 500 V / div., 10 ms / div.
 CH3: V_{OUT} , 5 V / div., 10 ms / div.
 CH4: I_{OUT} , 250 mA / div., 10 ms / div.
 Rise Time = 9.6776 ms.

11.4.1.2 0% Load

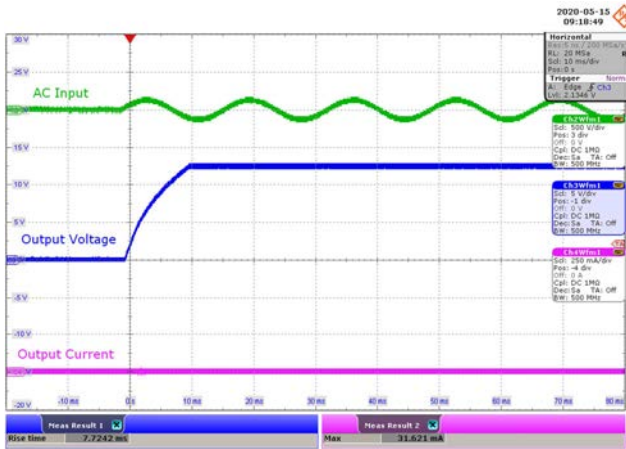

Figure 55 – 90 VAC 60 Hz.

CH2: V_{IN} , 500 V / div., 10 ms / div.
 CH3: V_{OUT} , 5 V / div., 10 ms / div.
 CH4: I_{OUT} , 250 mA / div., 10 ms / div.
 Rise Time = 7.7242 ms.

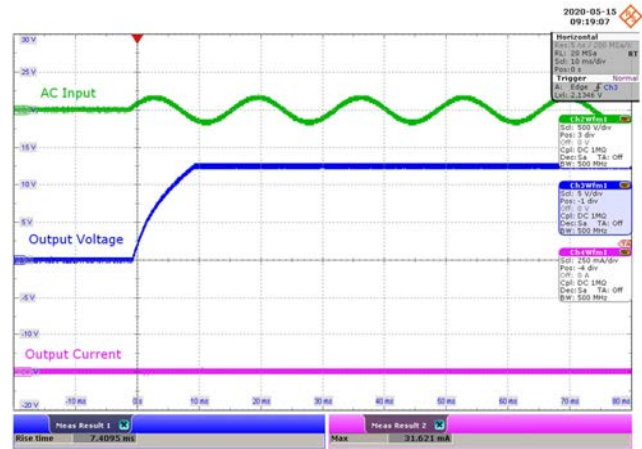

Figure 56 – 115 VAC 60 Hz.

CH2: V_{IN} , 500 V / div., 10 ms / div.
 CH3: V_{OUT} , 5 V / div., 10 ms / div.
 CH4: I_{OUT} , 250 mA / div., 10 ms / div.
 Rise Time = 7.4095 ms.

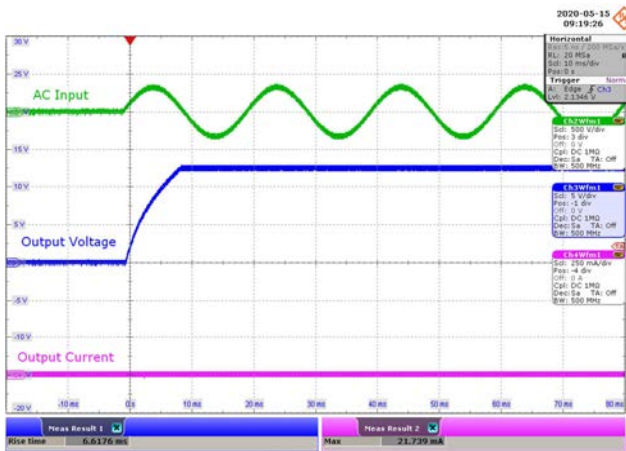

Figure 57 – 230 VAC 50 Hz.

CH2: V_{IN} , 500 V / div., 10 ms / div.
 CH3: V_{OUT} , 5 V / div., 10 ms / div.
 CH4: I_{OUT} , 250 mA / div., 10 ms / div.
 Rise Time = 6.6176 ms.

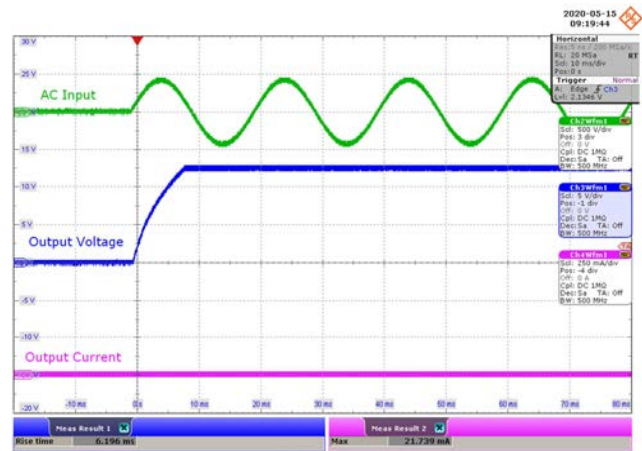

Figure 58 – 300 VAC 50 Hz.

CH2: V_{IN} , 500 V / div., 10 ms / div.
 CH3: V_{OUT} , 5 V / div., 10 ms / div.
 CH4: I_{OUT} , 250 mA / div., 10 ms / div.
 Rise Time = 6.196 ms.



11.4.2 CR Mode

11.4.2.1 100% Load

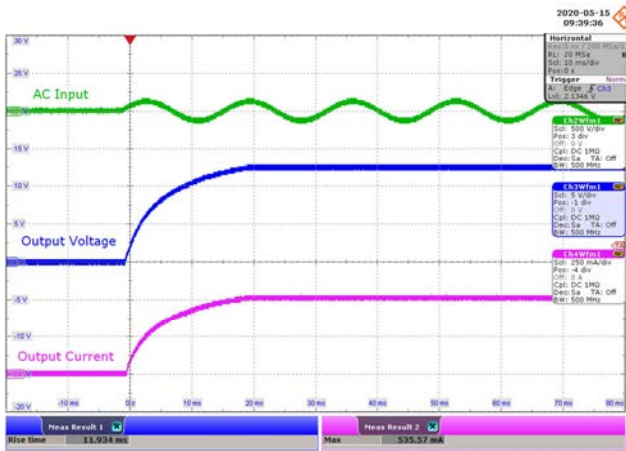

Figure 59 – 90 VAC 60 Hz.
 CH2: V_{IN} , 500 V / div., 10 ms / div.
 CH3: V_{OUT} , 5 V / div., 10 ms / div.
 CH4: I_{OUT} , 250 mA / div., 10 ms / div.
 Rise Time = 11.934 ms.

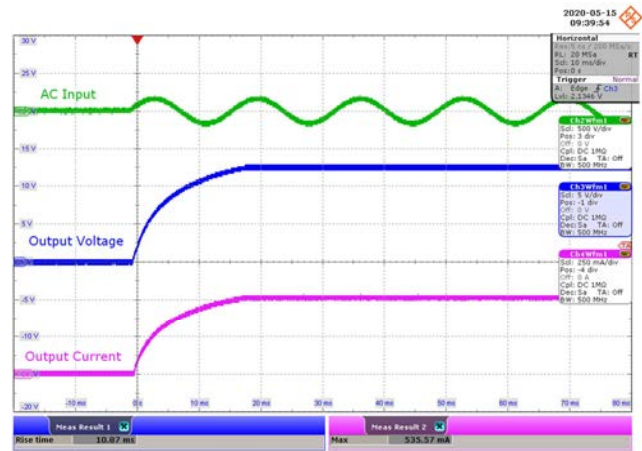

Figure 60 – 115 VAC 60 Hz.
 CH2: V_{IN} , 500 V / div., 10 ms / div.
 CH3: V_{OUT} , 5 V / div., 10 ms / div.
 CH4: I_{OUT} , 250 mA / div., 10 ms / div.
 Rise Time = 10.87 ms.

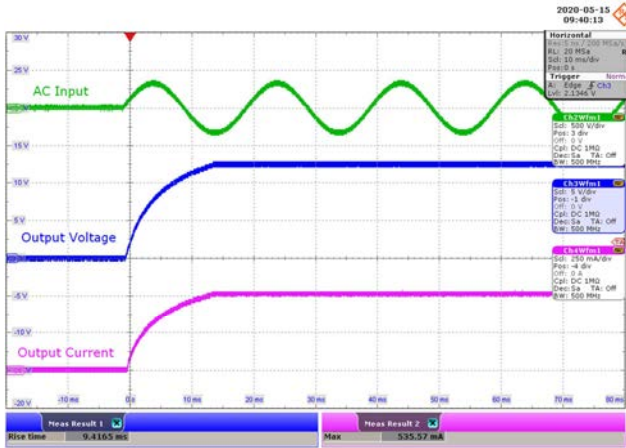

Figure 61 – 230 VAC 50 Hz.
 CH2: V_{IN} , 500 V / div., 10 ms / div.
 CH3: V_{OUT} , 5 V / div., 10 ms / div.
 CH4: I_{OUT} , 250 mA / div., 10 ms / div.
 Rise Time = 9.4165 ms.

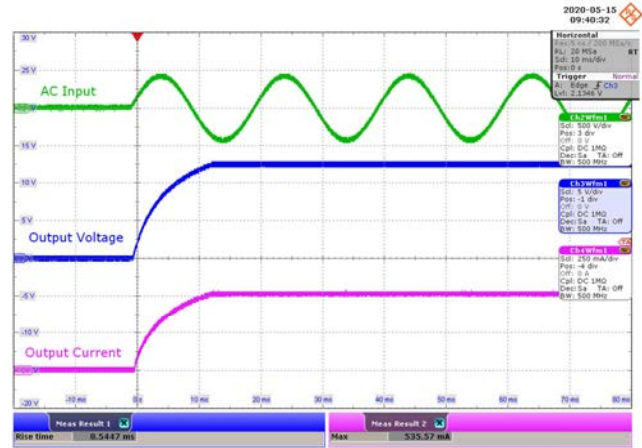

Figure 62 – 300 VAC 50 Hz.
 CH2: V_{IN} , 500 V / div., 10 ms / div.
 CH3: V_{OUT} , 5 V / div., 10 ms / div.
 CH4: I_{OUT} , 250 mA / div., 10 ms / div.
 Rise Time = 8.5447 ms.

11.4.2.2 0% Load

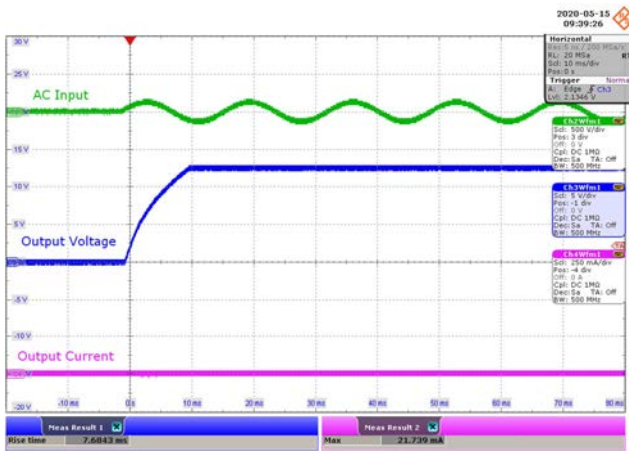

Figure 63 – 90 VAC 60 Hz.

CH2: V_{IN} , 500 V / div., 10 ms / div.
 CH3: V_{OUT} , 5 V / div., 10 ms / div.
 CH4: I_{OUT} , 250 mA / div., 10 ms / div.
 Rise Time = 7.6843 ms.

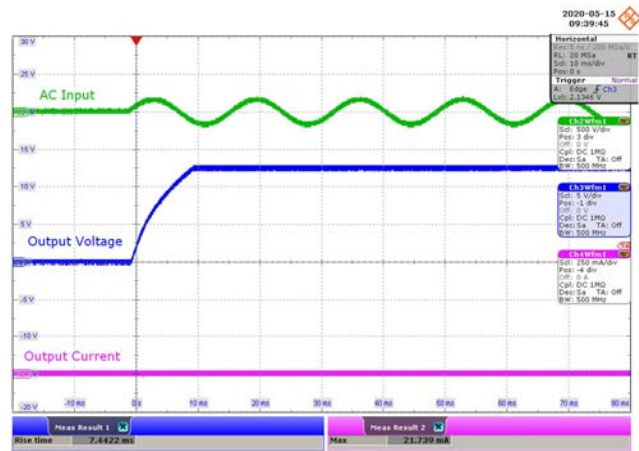

Figure 64 – 115 VAC 60 Hz.

CH2: V_{IN} , 500 V / div., 10 ms / div.
 CH3: V_{OUT} , 5 V / div., 10 ms / div.
 CH4: I_{OUT} , 250 mA / div., 10 ms / div.
 Rise Time = 7.4422 ms.

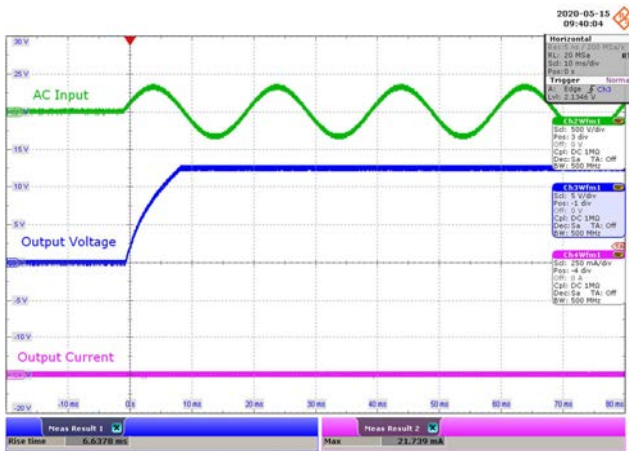

Figure 65 – 230 VAC 50 Hz.

CH2: V_{IN} , 500 V / div., 10 ms / div.
 CH3: V_{OUT} , 5 V / div., 10 ms / div.
 CH4: I_{OUT} , 250 mA / div., 10 ms / div.
 Rise Time = 6.6378 ms.

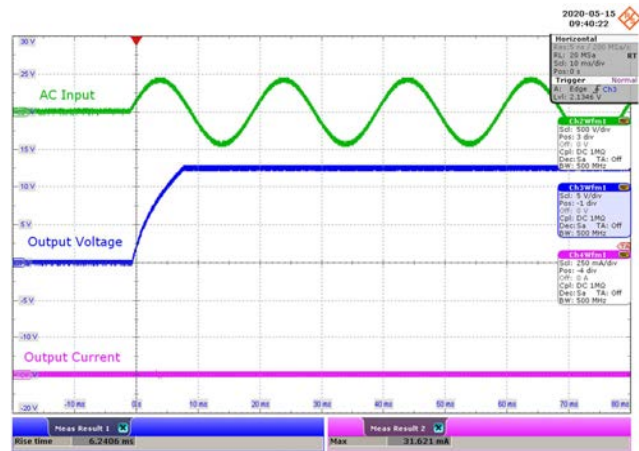

Figure 66 – 265 VAC 50 Hz.

CH2: V_{IN} , 500 V / div., 10 ms / div.
 CH3: V_{OUT} , 5 V / div., 10 ms / div.
 CH4: I_{OUT} , 250 mA / div., 10 ms / div.
 Rise Time = 6.2406 ms.

11.5 Switching Waveforms

11.5.1 Primary MOSFET Drain-Source Voltage and Current at Normal Operation

11.5.1.1 100% Load

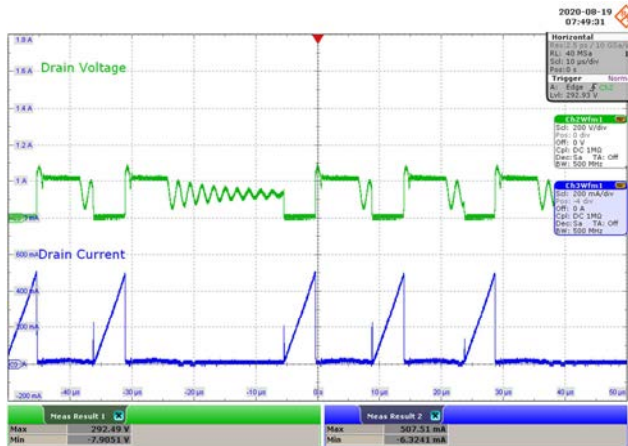

Figure 67 – 90 VAC 60 Hz.

CH2: V_{DS} , 200 V / div., 10 μ s / div.
 CH3: I_{DS} , 200 mA / div., 10 μ s / div.
 $V_{DS(MAX)}$ = 292.49 V.
 $I_{DS(MAX)}$ = 507.51 mA.

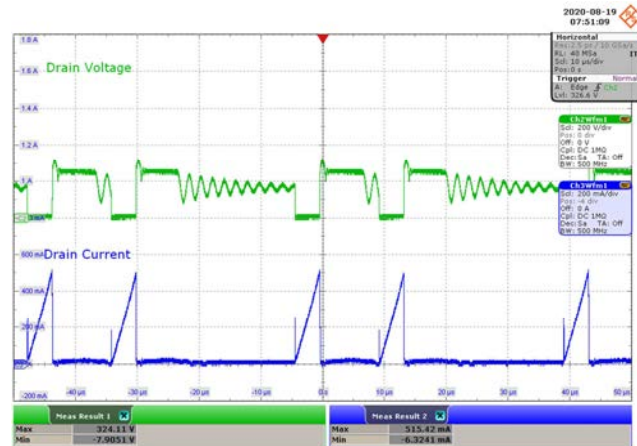

Figure 68 – 115 VAC 60 Hz.

CH2: V_{DS} , 200 V / div., 10 μ s / div.
 CH3: I_{DS} , 200 mA / div., 10 μ s / div.
 $V_{DS(MAX)}$ = 324.11 V.
 $I_{DS(MAX)}$ = 515.42 mA.

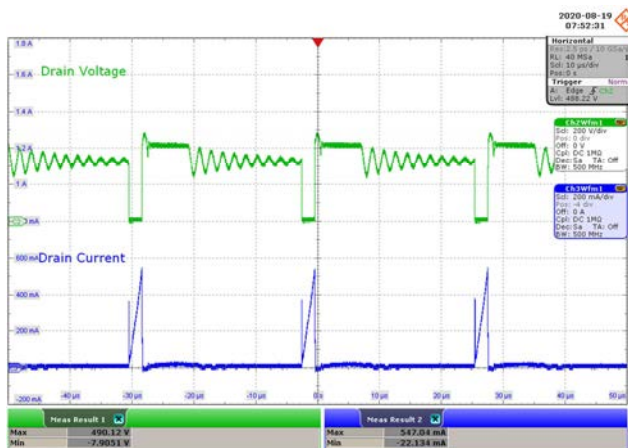

Figure 69 – 230 VAC 50 Hz.

CH2: V_{DS} , 200 V / div., 10 μ s / div.
 CH3: I_{DS} , 200 mA / div., 10 μ s / div.
 $V_{DS(MAX)}$ = 490.12 V.
 $I_{DS(MAX)}$ = 547.04 mA.

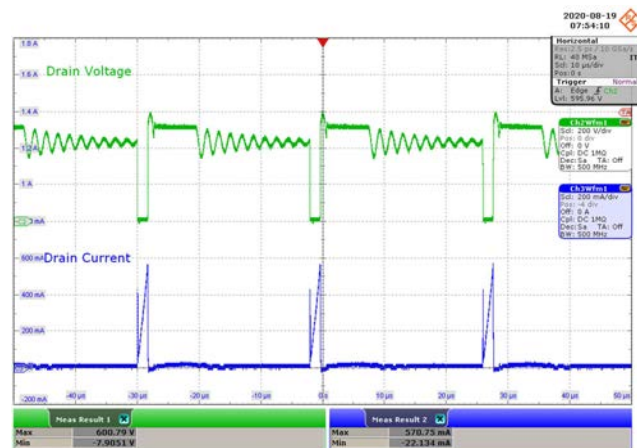

Figure 70 – 300 VAC 50 Hz.

CH2: V_{DS} , 200 V / div., 10 μ s / div.
 CH3: I_{DS} , 200 mA / div., 10 μ s / div.
 $V_{DS(MAX)}$ = 600.79 V.
 $I_{DS(MAX)}$ = 570.75 mA.

11.5.1.2 0% Load

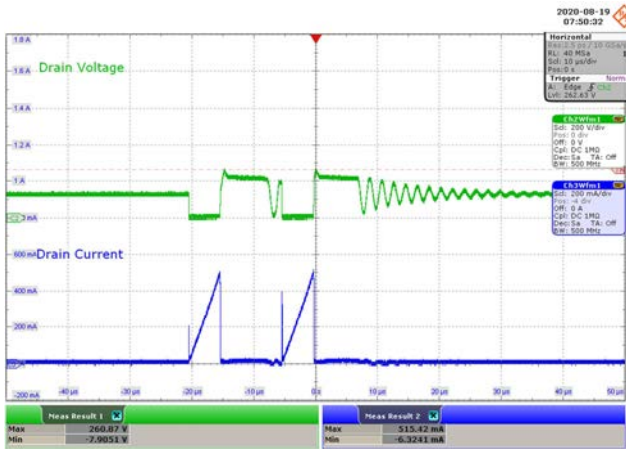

Figure 71 – 90 VAC 60 Hz.
 CH2: V_{DS}, 200 V / div., 10 μs / div.
 CH3: I_{DS}, 200 mA / div., 10 μs / div.
 V_{DS(MAX)} = 260.87 V.
 I_{DS(MAX)} = 515.42 mA.

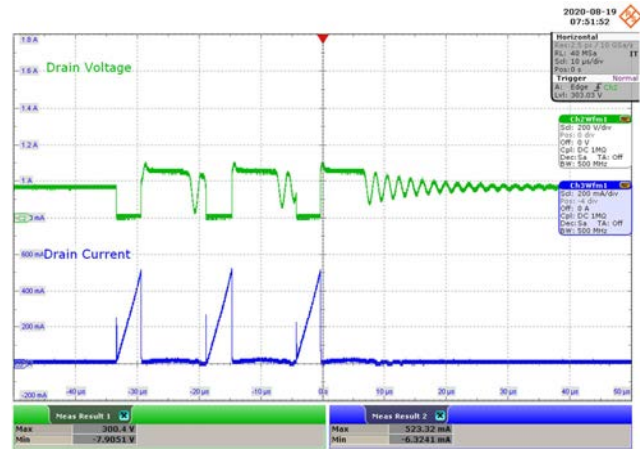

Figure 72 – 115 VAC 60 Hz.
 CH2: V_{DS}, 200 V / div., 10 μs / div.
 CH3: I_{DS}, 200 mA / div., 10 μs / div.
 V_{DS(MAX)} = 300.40 V.
 I_{DS(MAX)} = 523.32 mA.

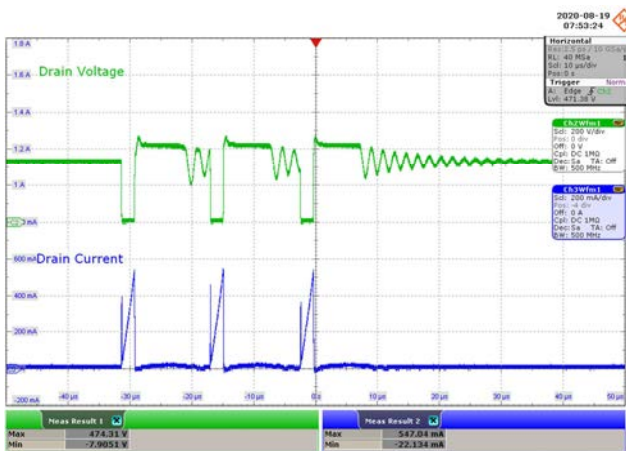

Figure 73 – 230 VAC 50 Hz.
 CH2: V_{DS}, 200 V / div., 10 μs / div.
 CH3: I_{DS}, 200 mA / div., 10 μs / div.
 V_{DS(MAX)} = 474.31 V.
 I_{DS(MAX)} = 547.04 mA.

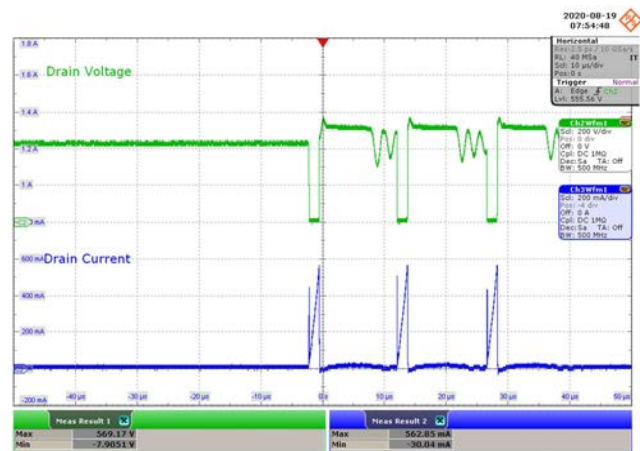
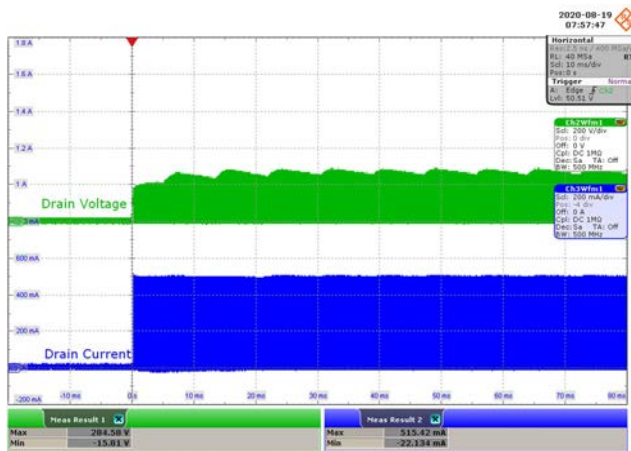

Figure 74 – 300 VAC 50 Hz.
 CH2: V_{DS}, 200 V / div., 10 μs / div.
 CH3: I_{DS}, 200 mA / div., 10 μs / div.
 V_{DS(MAX)} = 569.17 V.
 I_{DS(MAX)} = 562.85 mA.

11.5.2 Primary MOSFET Drain-Source Voltage and Current at Start-up Operation

11.5.2.1 100% Load

**Figure 75** – 90 VAC 60 Hz.

CH2: V_{DS} , 200 V / div., 10 ms / div.
 CH3: I_{DS} , 200 mA / div., 10 ms / div.
 $V_{DS(MAX)} = 284.58$ V.
 $I_{DS(MAX)} = 515.42$ mA.

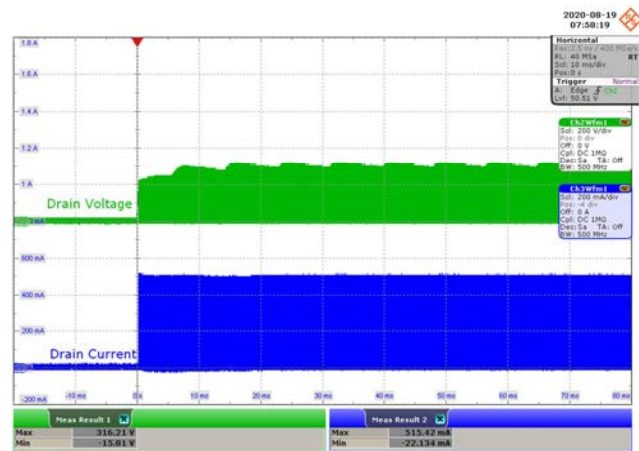
**Figure 76** – 115 VAC 60 Hz.

CH2: V_{DS} , 200 V / div., 10 ms / div.
 CH3: I_{DS} , 200 mA / div., 10 ms / div.
 $V_{DS(MAX)} = 316.21$ V.
 $I_{DS(MAX)} = 515.42$ mA.

**Figure 77** – 230 VAC 50 Hz.

CH2: V_{DS} , 200 V / div., 10 ms / div.
 CH3: I_{DS} , 200 mA / div., 10 ms / div.
 $V_{DS(MAX)} = 490.12$ V.
 $I_{DS(MAX)} = 547.04$ mA.

**Figure 78** – 300 VAC 50 Hz.

CH2: V_{DS} , 200 V / div., 10 ms / div.
 CH3: I_{DS} , 200 mA / div., 10 ms / div.
 $V_{DS(MAX)} = 600.79$ V.
 $I_{DS(MAX)} = 562.85$ mA.

11.5.2.2 0% Load

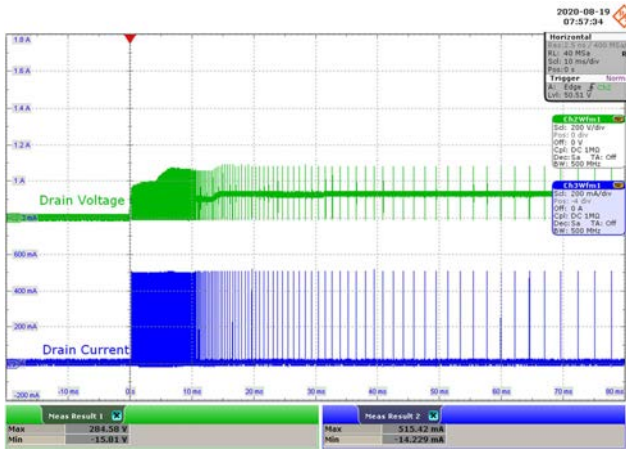

Figure 79 – 90 VAC 60 Hz.
 CH2: V_{DS} , 200 V / div., 10 ms / div.
 CH3: I_{DS} , 200 mA / div., 10 ms / div.
 $V_{DS(MAX)} = 284.58$ V.
 $I_{DS(MAX)} = 515.42$ mA.

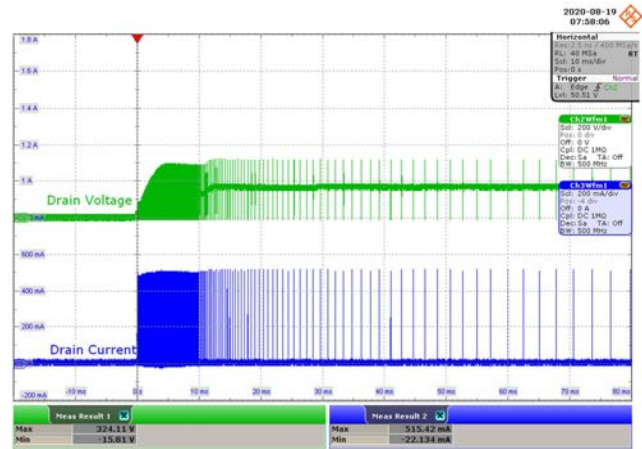

Figure 80 – 115 VAC 60 Hz.
 CH2: V_{DS} , 200 V / div., 10 ms / div.
 CH3: I_{DS} , 200 mA / div., 10 ms / div.
 $V_{DS(MAX)} = 324.11$ V.
 $I_{DS(MAX)} = 515.42$ mA.

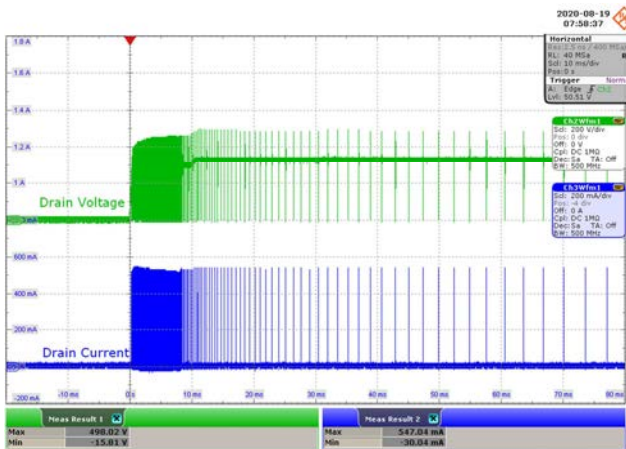

Figure 81 – 230 VAC 50 Hz.
 CH2: V_{DS} , 200 V / div., 10 ms / div.
 CH3: I_{DS} , 200 mA / div., 10 ms / div.
 $V_{DS(MAX)} = 498.02$ V.
 $I_{DS(MAX)} = 547.04$ mA.

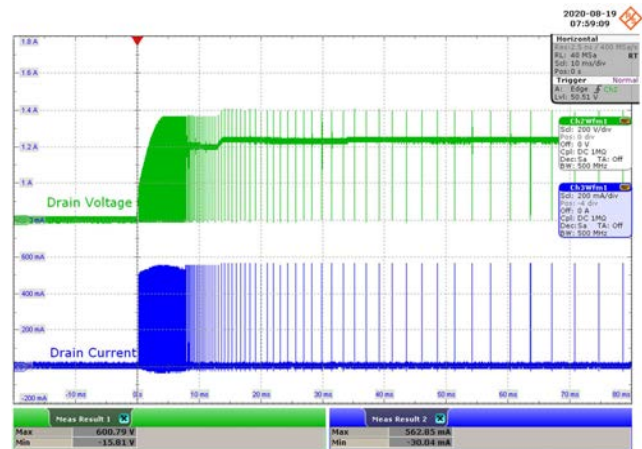

Figure 82 – 300 VAC 50 Hz.
 CH2: V_{DS} , 200 V / div., 10 ms / div.
 CH3: I_{DS} , 200 mA / div., 10 ms / div.
 $V_{DS(MAX)} = 600.79$ V.
 $I_{DS(MAX)} = 562.85$ mA.

11.5.3 Output Diode Voltage and Current at Normal Operation

11.5.3.1 100% Load

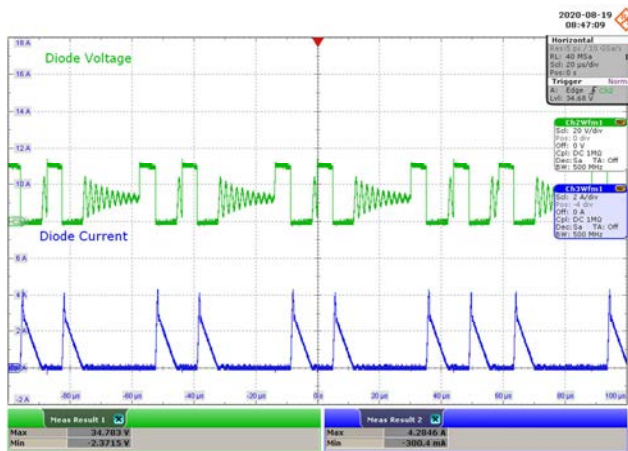

Figure 83 – 90 VAC 60 Hz.
 CH2: V_D , 20 V / div., 20 μ s / div.
 CH3: I_D , 2 A / div., 20 μ s / div.
 PIV = 34.783 V.
 $I_{D(MAX)}$ = 4.2846 A.

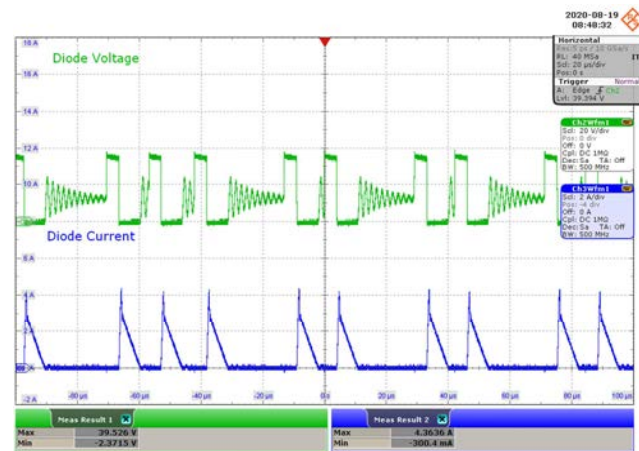

Figure 84 – 115 VAC 60 Hz.
 CH2: V_D , 20 V / div., 20 μ s / div.
 CH3: I_D , 2 A / div., 20 μ s / div.
 PIV = 39.526 V.
 $I_{D(MAX)}$ = 4.3636 A.

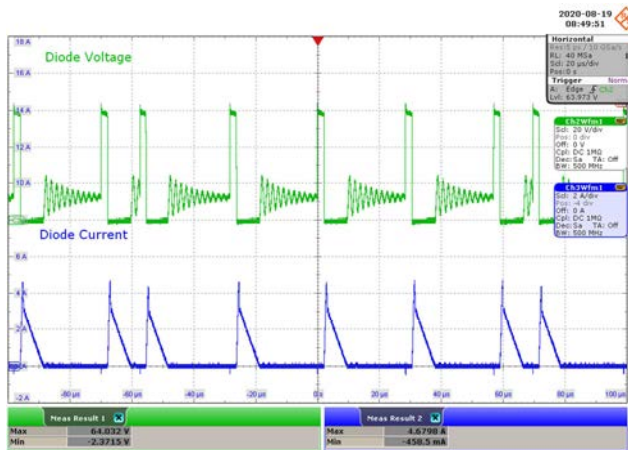

Figure 85 – 230 VAC 50 Hz.
 CH2: V_D , 20 V / div., 20 μ s / div.
 CH3: I_D , 2 A / div., 20 μ s / div.
 PIV = 64.032 V.
 $I_{D(MAX)}$ = 4.6798 A.

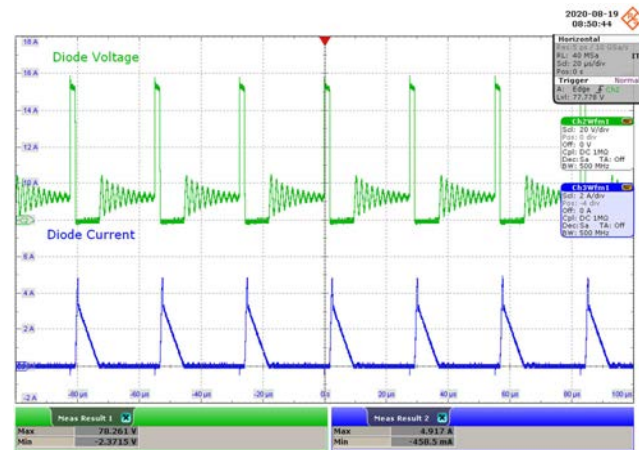

Figure 86 – 300 VAC 50 Hz.
 CH2: V_D , 20 V / div., 20 μ s / div.
 CH3: I_D , 2 A / div., 20 μ s / div.
 PIV = 78.261 V.
 $I_{D(MAX)}$ = 4.917 A.

11.5.3.2 0% Load

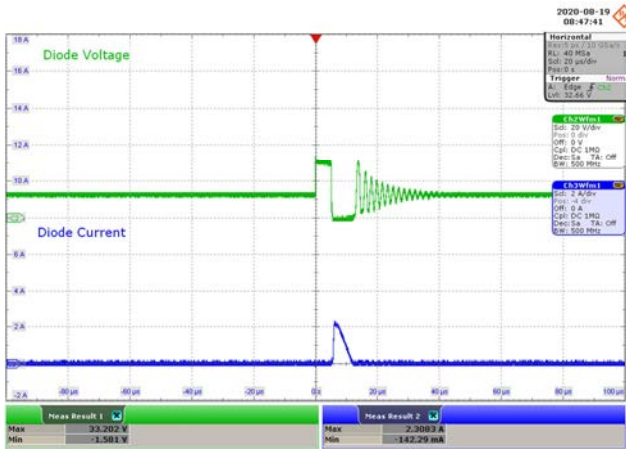

Figure 87 – 90 VAC 60 Hz.
 CH2: V_D, 20 V / div., 20 μs / div.
 CH3: I_D, 2 A / div., 20 μs / div.
 PIV = 33.202 V.
 I_{D(MAX)} = 2.3083 A.

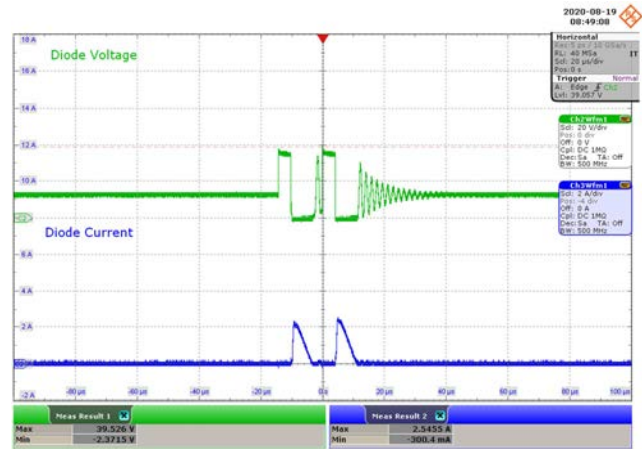

Figure 88 – 115 VAC 60 Hz.
 CH2: V_D, 20 V / div., 20 μs / div.
 CH3: I_D, 2 A / div., 20 μs / div.
 PIV = 39.526 V.
 I_{D(MAX)} = 2.5455 A.

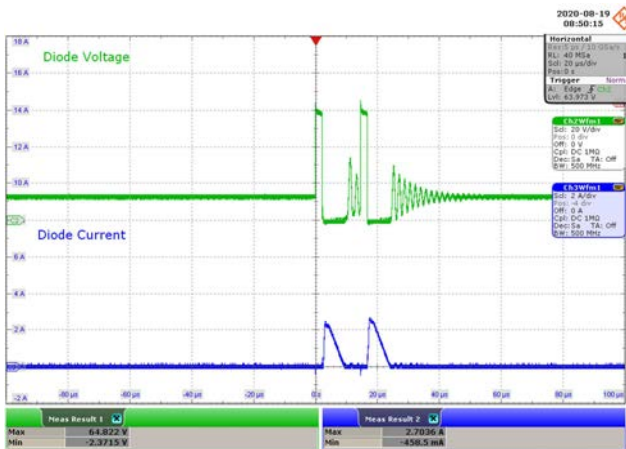

Figure 89 – 230 VAC 50 Hz.
 CH2: V_D, 20 V / div., 20 μs / div.
 CH3: I_D, 2 A / div., 20 μs / div.
 PIV = 64.822 V.
 I_{D(MAX)} = 2.7036 A.

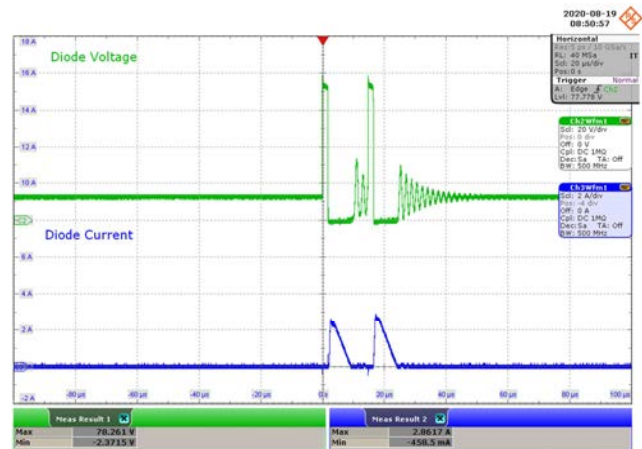

Figure 90 – 300 VAC 50 Hz.
 CH2: V_D, 20 V / div., 20 μs / div.
 CH3: I_D, 2 A / div., 20 μs / div.
 PIV = 78.261 V.
 I_{D(MAX)} = 2.8617 A.

11.5.4 Output Diode Voltage and Current at Start-up Operation

11.5.4.1 100% Load

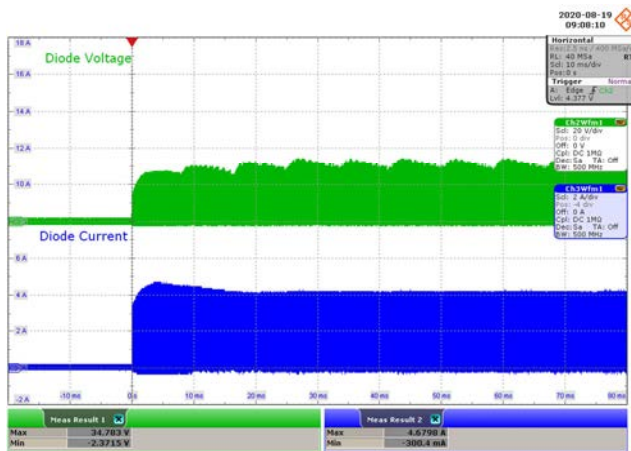

Figure 91 – 90 VAC 60 Hz.
 CH2: V_D , 20 V / div., 10 ms / div.
 CH3: I_D , 2 A / div., 10 ms / div.
 PIV = 34.783 V.
 $I_{D(MAX)} = 4.6798$ A.

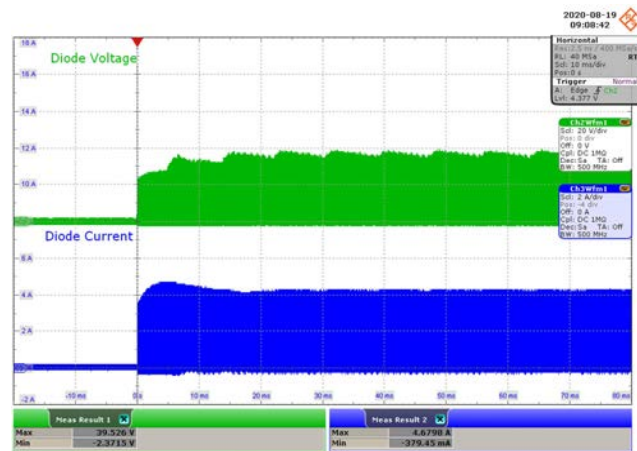

Figure 92 – 115 VAC 60 Hz.
 CH2: V_D , 20 V / div., 10 ms / div.
 CH3: I_D , 2 A / div., 10 ms / div.
 PIV = 39.526 V.
 $I_{D(MAX)} = 4.6798$ A.

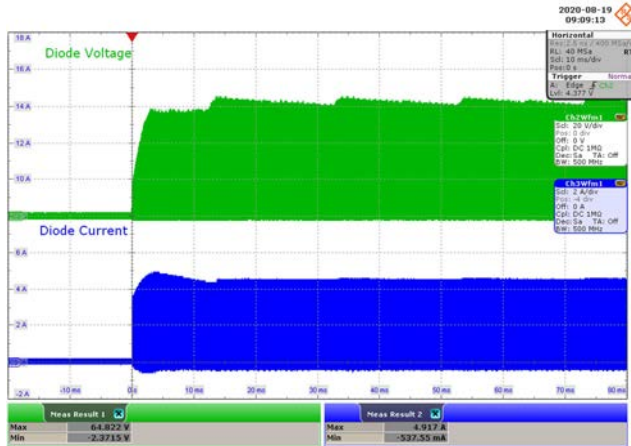

Figure 93 – 230 VAC 50 Hz.
 CH2: V_D , 20 V / div., 10 ms / div.
 CH3: I_D , 2 A / div., 10 ms / div.
 PIV = 64.822 V.
 $I_{D(MAX)} = 4.917$ A.

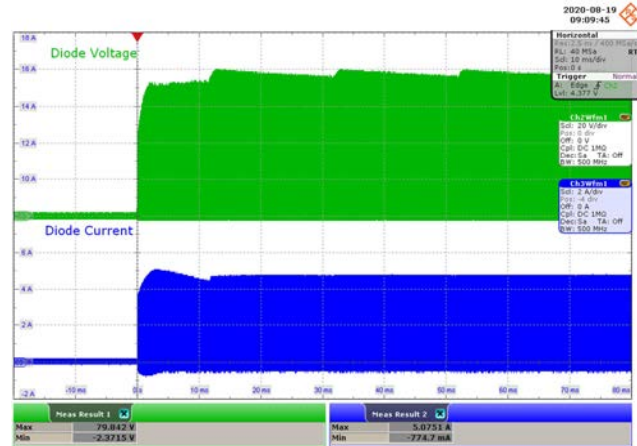

Figure 94 – 300 VAC 50 Hz.
 CH2: V_D , 20 V / div., 10 ms / div.
 CH3: I_D , 2 A / div., 10 ms / div.
 PIV = 79.842 V.
 $I_{D(MAX)} = 5.0751$ A.

11.5.4.2 0% Load

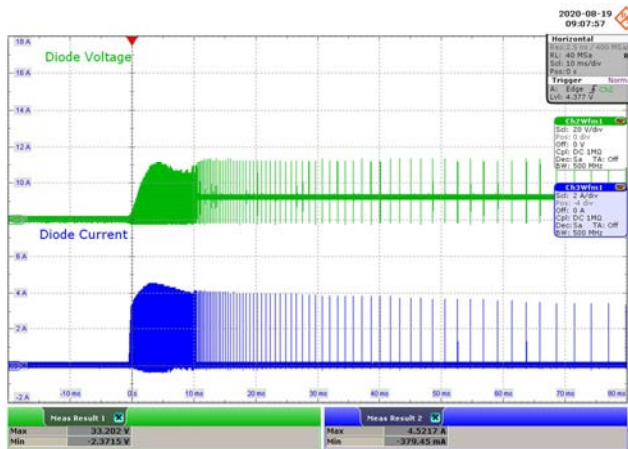

Figure 95 – 90 VAC 60 Hz.
 CH2: V_D , 20 V / div., 10 ms / div.
 CH3: I_D , 2 A / div., 10 ms / div.
 PIV = 33.202 V.
 $I_{D(MAX)}$ = 4.5217 A.

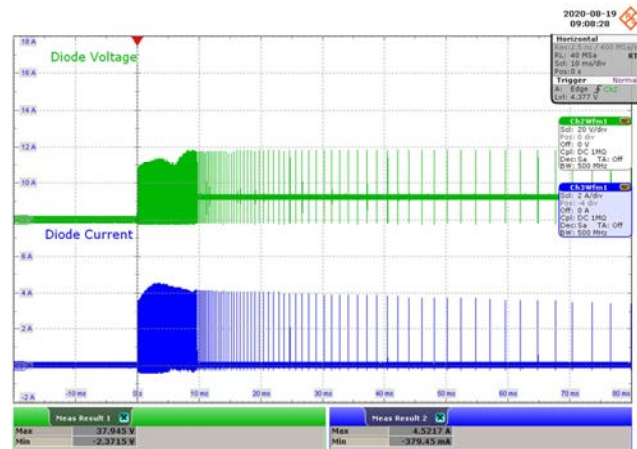

Figure 96 – 115 VAC 60 Hz.
 CH2: V_D , 20 V / div., 10 ms / div.
 CH3: I_D , 2 A / div., 10 ms / div.
 PIV = 37.945 V.
 $I_{D(MAX)}$ = 4.5217 A.

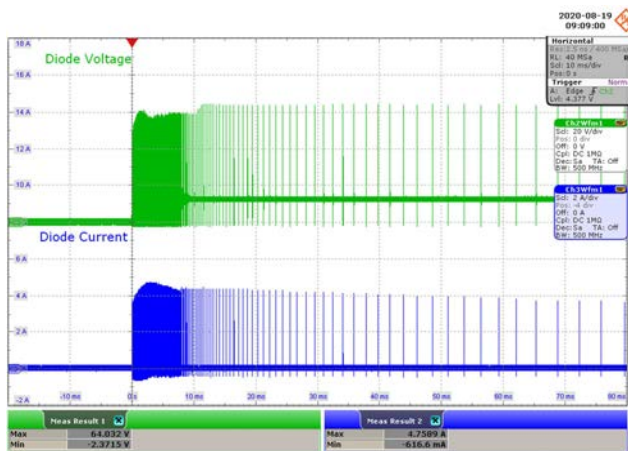

Figure 97 – 230 VAC 50 Hz.
 CH2: V_D , 20 V / div., 10 ms / div.
 CH3: I_D , 2 A / div., 10 ms / div.
 PIV = 64.032 V.
 $I_{D(MAX)}$ = 4.7589 A.

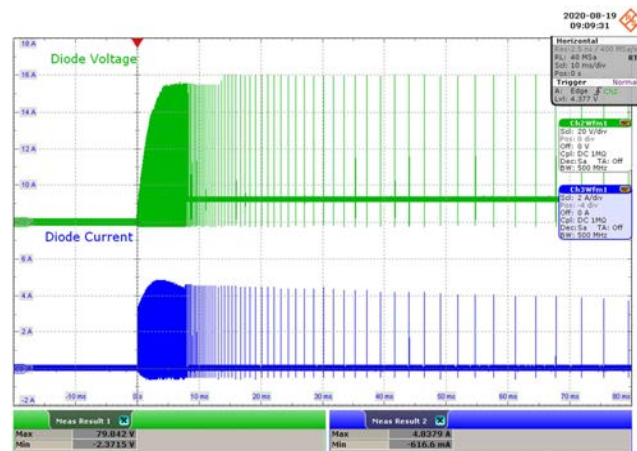

Figure 98 – 300 VAC 50 Hz.
 CH2: V_D , 20 V / div., 10 ms / div.
 CH3: I_D , 2 A / div., 10 ms / div.
 PIV = 79.842 V.
 $I_{D(MAX)}$ = 4.8379 A.

11.6 Brown-In and Brown-Out

11.6.1 Brown-in

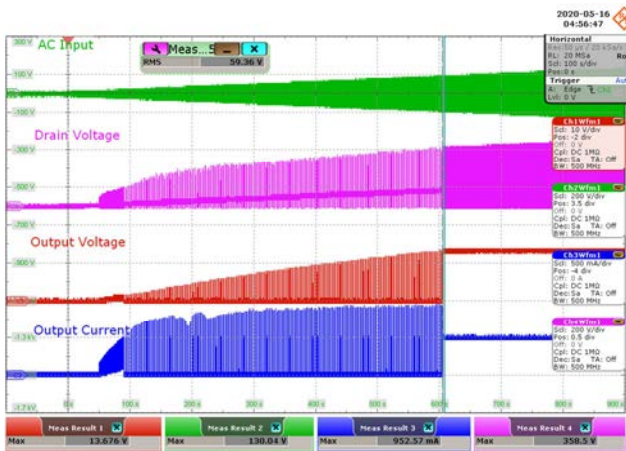

Figure 99 – Brown-in, Full Load.

CH1: V_{OUT} , 10 V / div., 100 s / div.
 CH2: V_{IN} , 200 V / div., 100 s / div.
 CH3: I_{OUT} , 500 mA / div., 100 s / div.
 CH4: V_{DS} , 200 V / div., 100 s / div.

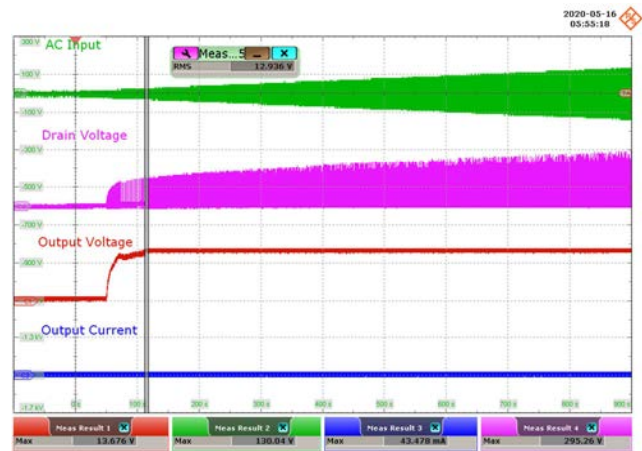

Figure 100 – Brown-in, No Load.

CH1: V_{OUT} , 10 V / div., 100 s / div.
 CH2: V_{IN} , 200 V / div., 100 s / div.
 CH3: I_{OUT} , 500 mA / div., 100 s / div.
 CH4: V_{DS} , 200 V / div., 100 s / div.

11.6.2 Brown-out

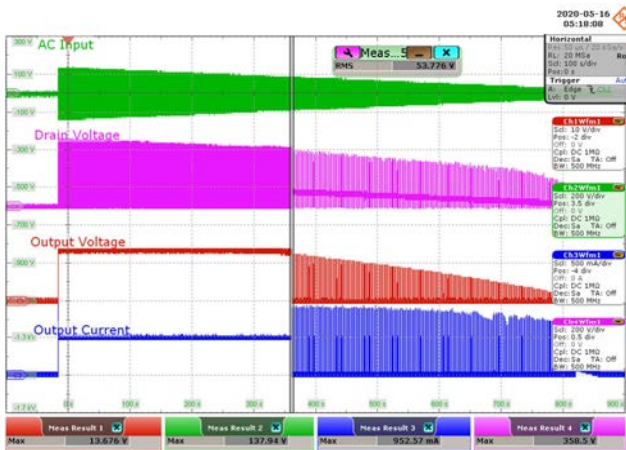

Figure 101 – Brown-out, Full Load.

CH1: V_{OUT} , 10 V / div., 100 s / div.
 CH2: V_{IN} , 200 V / div., 100 s / div.
 CH3: I_{OUT} , 500 mA / div., 100 s / div.
 CH4: V_{DS} , 200 V / div., 100 s / div.

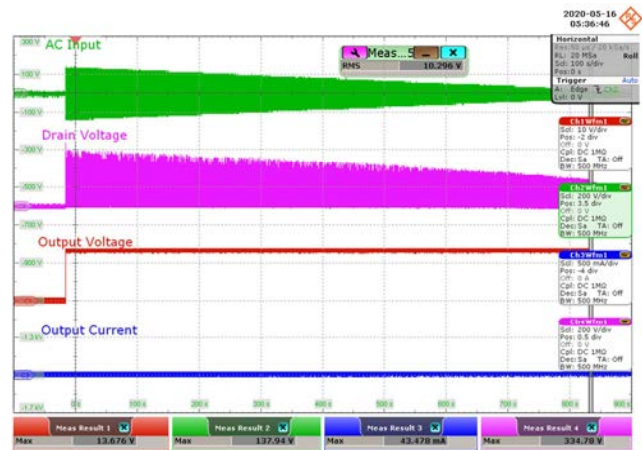

Figure 102 – Brown-out, No Load.

CH1: V_{OUT} , 10 V / div., 100 s / div.
 CH2: V_{IN} , 200 V / div., 100 s / div.
 CH3: I_{OUT} , 500 mA / div., 100 s / div.
 CH4: V_{DS} , 200 V / div., 100 s / div.

11.7 Fault Conditions

11.7.1 Output Overvoltage

11.7.1.1 100% Load

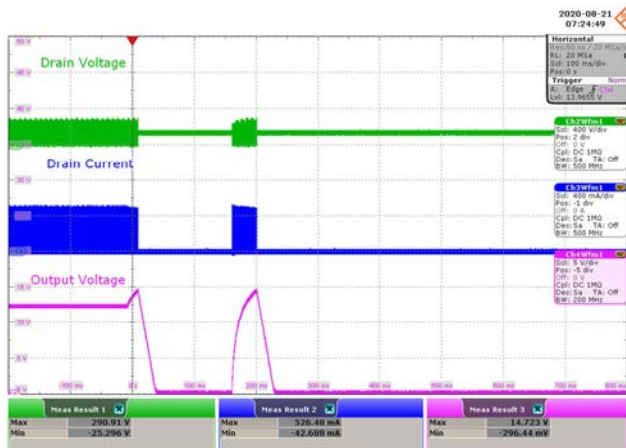

Figure 103 – 90 VAC 60 Hz.

CH2: V_{DS} , 400 V / div., 100 ms / div.
 CH3: I_{DS} , 400 mA / div., 100 ms / div.
 CH4: V_{OUT} , 5 V / div., 100 ms / div.
 $V_{OUT(MAX)} = 14.723$ V.

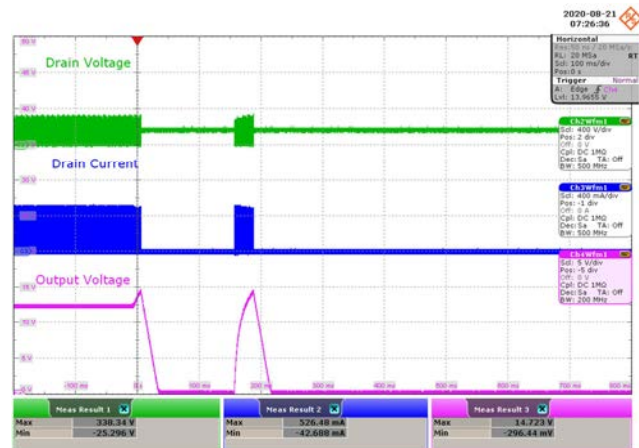

Figure 104 – 115 VAC 60 Hz.

CH2: V_{DS} , 400 V / div., 100 ms / div.
 CH3: I_{DS} , 400 mA / div., 100 ms / div.
 CH4: V_{OUT} , 5 V / div., 100 ms / div.
 $V_{OUT(MAX)} = 14.723$ V.

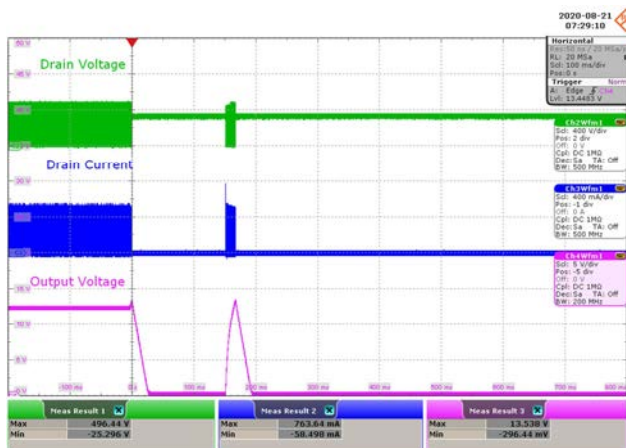

Figure 105 – 230 VAC 50 Hz.

CH2: V_{DS} , 400 V / div., 100 ms / div.
 CH3: I_{DS} , 400 mA / div., 100 ms / div.
 CH4: V_{OUT} , 5 V / div., 100 ms / div.
 $V_{OUT(MAX)} = 13.538$ V.

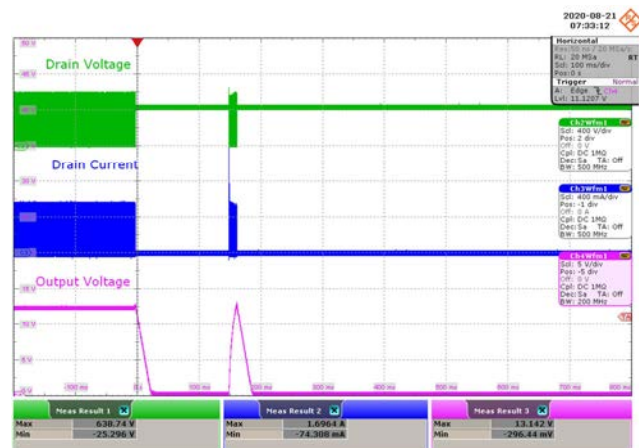

Figure 106 – 300 VAC 50 Hz.

CH2: V_{DS} , 400 V / div., 100 ms / div.
 CH3: I_{DS} , 400 mA / div., 100 ms / div.
 CH4: V_{OUT} , 5 V / div., 100 ms / div.
 $V_{OUT(MAX)} = 13.142$ V.

11.7.1.2 0% Load

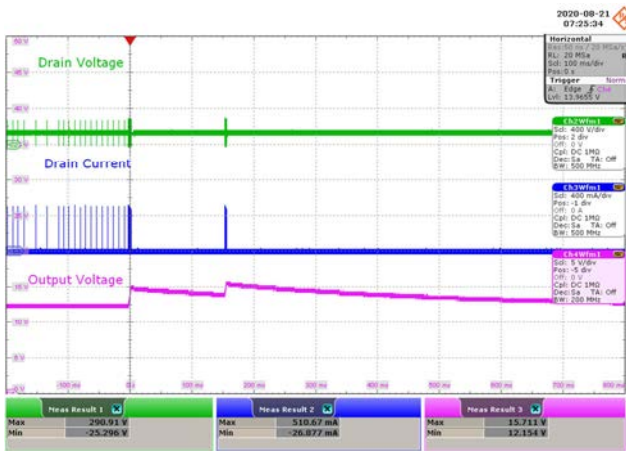

Figure 107 – 90 VAC 60 Hz.

CH2: V_{DS}, 400 V / div., 100 ms / div.
 CH3: I_{DS}, 400 mA / div., 100 ms / div.
 CH4: V_{OUT}, 5 V / div., 100 ms / div.
 V_{OUT(MAX)} = 15.711 V.

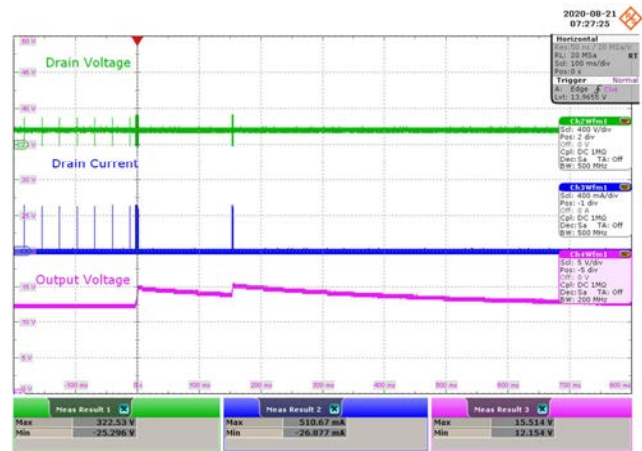

Figure 108 – 115 VAC 60 Hz.

CH2: V_{DS}, 400 V / div., 100 ms / div.
 CH3: I_{DS}, 400 mA / div., 100 ms / div.
 CH4: V_{OUT}, 5 V / div., 100 ms / div.
 V_{OUT(MAX)} = 15.514 V.

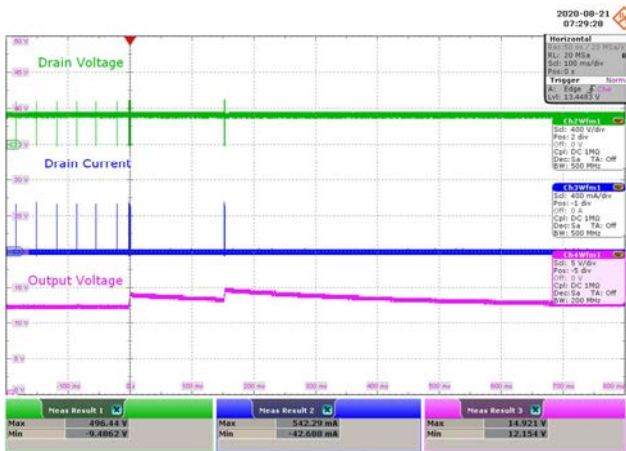

Figure 109 – 230 VAC 50 Hz.

CH2: V_{DS}, 400 V / div., 100 ms / div.
 CH3: I_{DS}, 400 mA / div., 100 ms / div.
 CH4: V_{OUT}, 5 V / div., 100 ms / div.
 V_{OUT(MAX)} = 14.921 V.

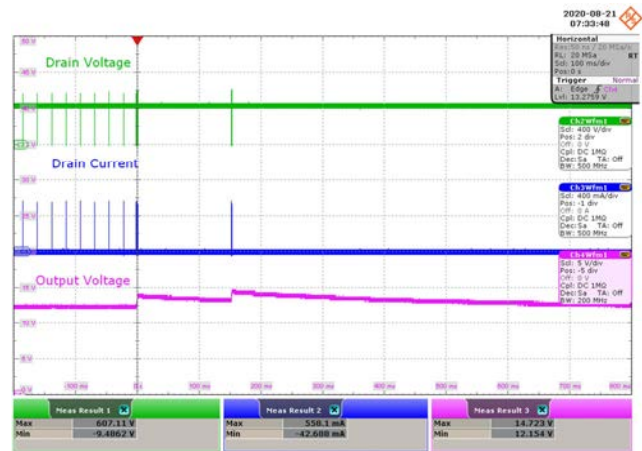

Figure 110 – 300 VAC 50 Hz.

CH2: V_{DS}, 400 V / div., 100 ms / div.
 CH3: I_{DS}, 400 mA / div., 100 ms / div.
 CH4: V_{OUT}, 5 V / div., 100 ms / div.
 V_{OUT(MAX)} = 14.723 V.

11.7.2 Output Short-Circuit

Test Condition: Short-circuit applied at normal operation



Figure 111 – 115 VAC 60 Hz.

CH2: V_{DS} , 400 V / div., 100 ms / div.
 CH3: I_{DS} , 400 mA / div., 100 ms / div.
 CH4: V_{OUT} , 5 V / div., 100 ms / div.
 $V_{DS(MAX)} = 338.34$ V.
 $I_{DS(MAX)} = 0.542$ A.

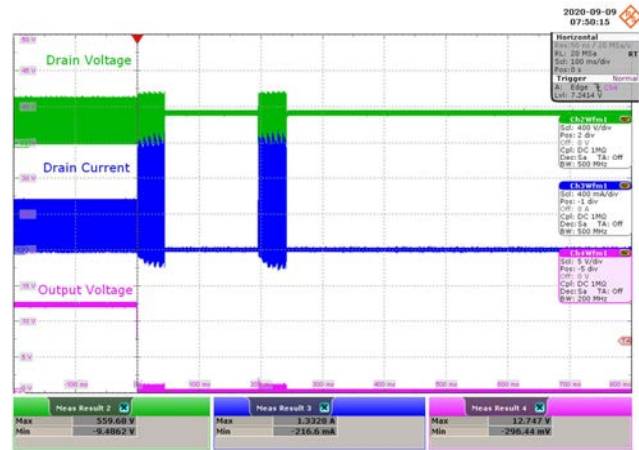

Figure 112 – 230 VAC 50 Hz.

CH2: V_{DS} , 400 V / div., 100 ms / div.
 CH3: I_{DS} , 400 mA / div., 100 ms / div.
 CH4: V_{OUT} , 5 V / div., 100 ms / div.
 $V_{DS(MAX)} = 559.68$ V.
 $I_{DS(MAX)} = 1.3328$ A.

11.8 *Output Voltage Ripple*

11.8.1 Ripple Measurement Technique

For DC output ripple measurements, a modified oscilloscope test probe must be utilized in order to reduce spurious signals due to pick-up. Details of the probe modification are provided in the Figures below.

The 4987BA probe adapter is affixed with two capacitors tied in parallel across the probe tip. The capacitors include one (1) 0.1 μF / 50 V ceramic type and one (1) 47 μF / 50 V aluminum electrolytic. The aluminum electrolytic type capacitor is polarized, so proper polarity across DC outputs must be maintained (see below).

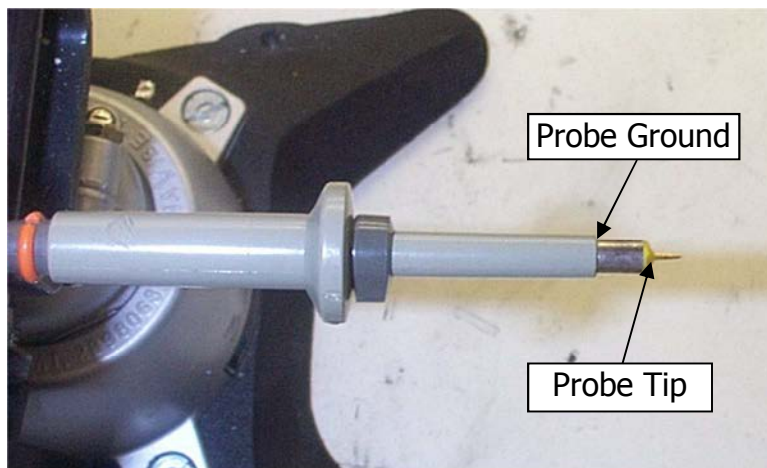

Figure 113 – Oscilloscope Probe Prepared for Ripple Measurement. (End Cap and Ground Lead Removed.)



Figure 114 – Oscilloscope Probe with Probe Master (www.probemaster.com) 4987A BNC Adapter. (Modified with wires for ripple measurement, and two parallel decoupling capacitors added.)

11.8.2 Measurement Results

11.8.2.1 100% Load Condition

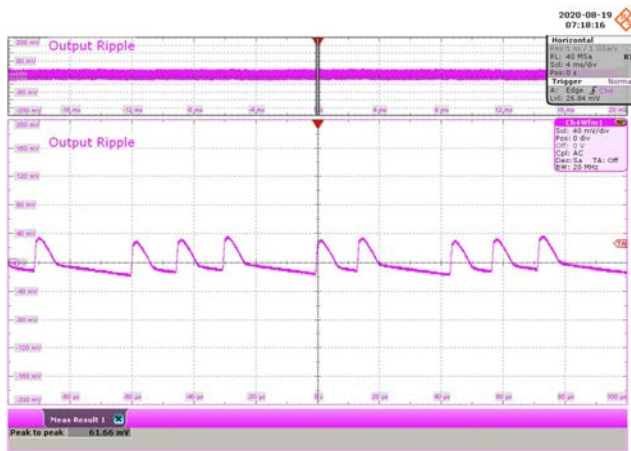

Figure 115 – 90 VAC 60 Hz.

CH4: V_{OUT}, 40 mV / div., 4 ms / div.Zoom: 20 μ s / div.

Output Ripple = 61.66 mV.

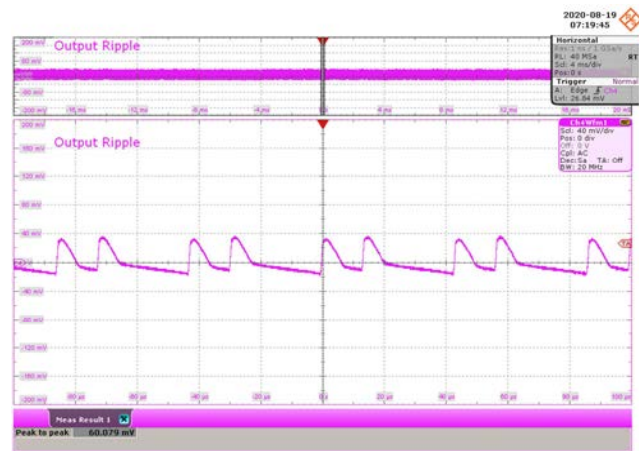

Figure 116 – 115 VAC 60 Hz.

CH4: V_{OUT}, 40 mV / div., 4 ms / div.Zoom: 20 μ s / div.

Output Ripple = 60.079 mV.

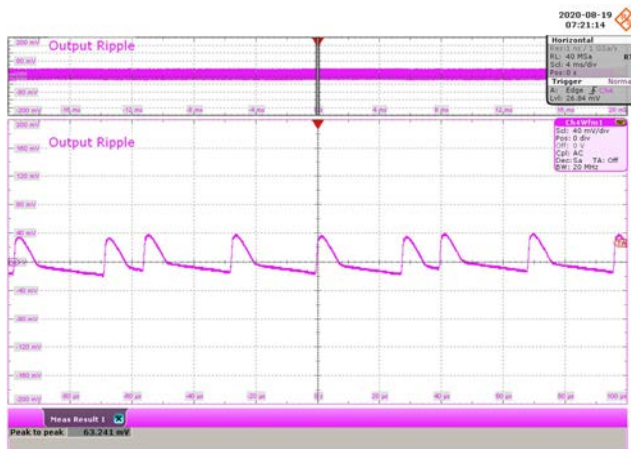

Figure 117 – 230 VAC 50 Hz.

CH4: V_{OUT}, 40 mV / div., 4 ms / div.Zoom: 20 μ s / div.

Output Ripple = 63.241 mV.

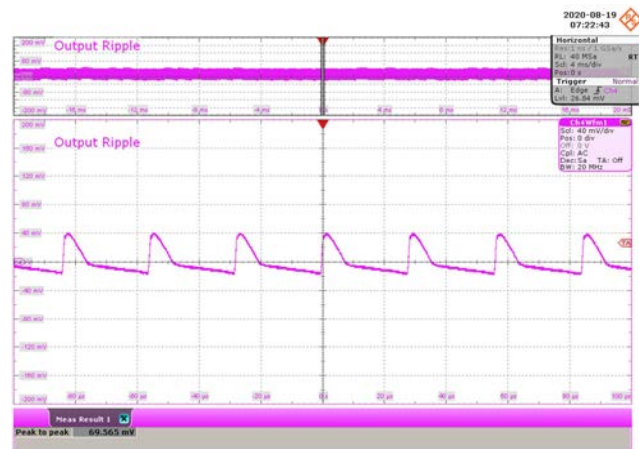

Figure 118 – 300 VAC 50 Hz.

CH4: V_{OUT}, 40 mV / div., 4 ms / div.Zoom: 20 μ s / div.

Output Ripple = 69.565 mV.

11.8.2.2 75% Load Condition

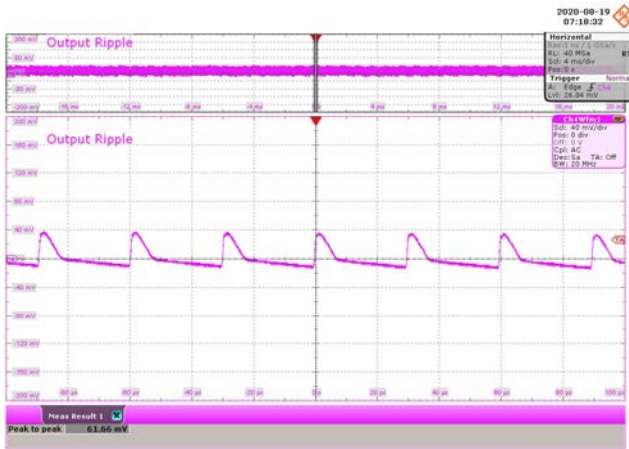

Figure 119 – 90 VAC 60 Hz.
 CH4: V_{OUT} , 40 mV / div., 4 ms / div.
 Zoom: 20 μ s / div.
 Output Ripple = 61.66 mV.

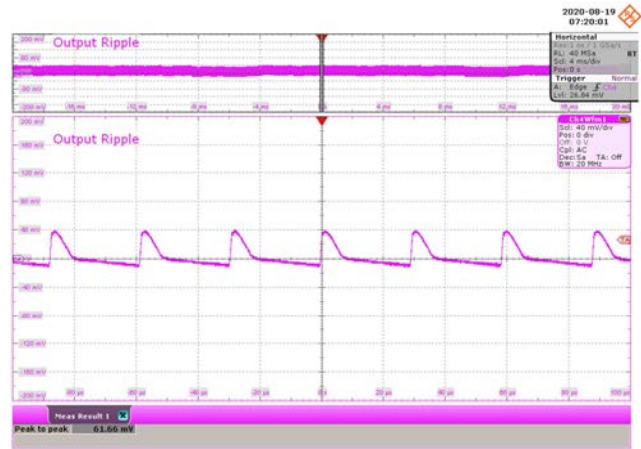

Figure 120 – 115 VAC 60 Hz.
 CH4: V_{OUT} , 40 mV / div., 4 ms / div.
 Zoom: 20 μ s / div.
 Output Ripple = 61.66 mV.

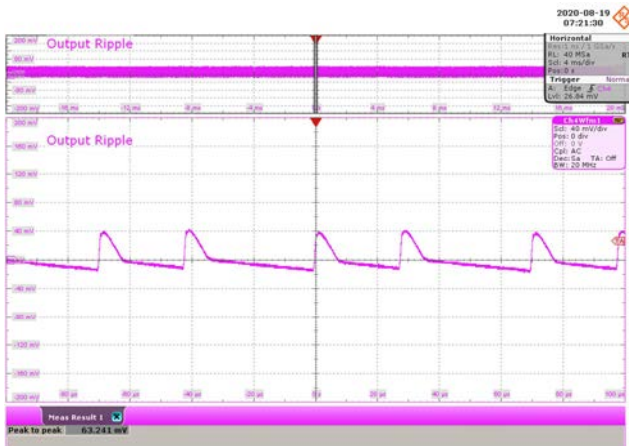

Figure 121 – 230 VAC 50 Hz.
 CH4: V_{OUT} , 40 mV / div., 4 ms / div.
 Zoom: 20 μ s / div.
 Output Ripple = 63.241 mV.

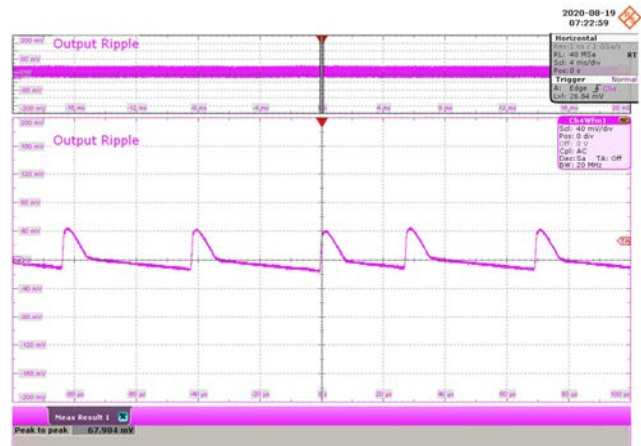

Figure 122 – 265 VAC 50 Hz.
 CH4: V_{OUT} , 40 mV / div., 4 ms / div.
 Zoom: 20 μ s / div.
 Output Ripple = 67.984 mV.

11.8.2.3 50% Load Condition

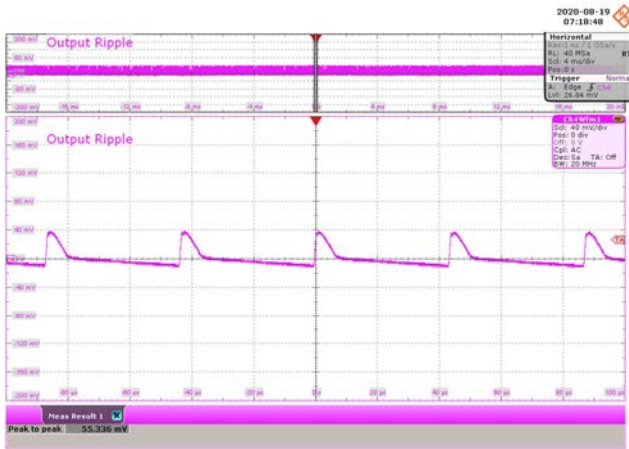

Figure 123 – 90 VAC 60 Hz.
CH4: V_{OUT} , 40 mV / div., 4 ms / div.
Zoom: 20 μ s / div.
Output Ripple = 55.336 mV.

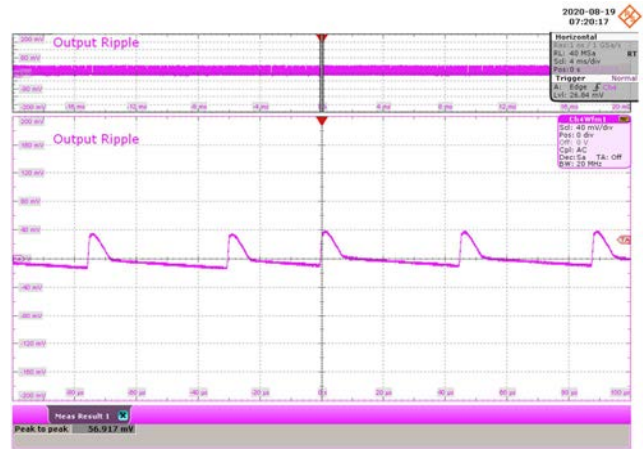

Figure 124 – 115 VAC 60 Hz.
CH4: V_{OUT} , 40 mV / div., 4 ms / div.
Zoom: 20 μ s / div.
Output Ripple = 56.917 mV.

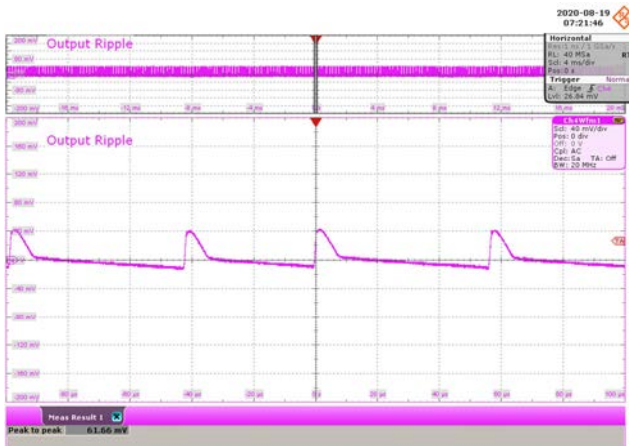

Figure 125 – 230 VAC 50 Hz.
CH4: V_{OUT} , 40 mV / div., 4 ms / div.
Zoom: 20 μ s / div.
Output Ripple = 61.66 mV.

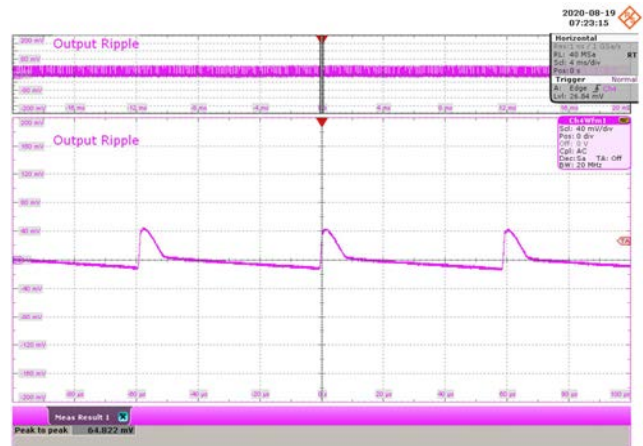

Figure 126 – 300 VAC 50 Hz.
CH4: V_{OUT} , 40 mV / div., 4 ms / div.
Zoom: 20 μ s / div.
Output Ripple = 64.822 mV.

11.8.2.4 25% Load Condition

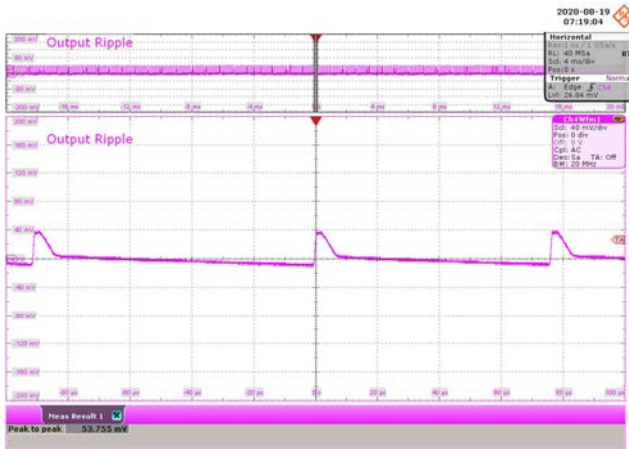

Figure 127 – 90 VAC 60 Hz.
 CH4: V_{OUT} , 40 mV / div., 4 ms / div.
 Zoom: 20 μ s / div.
 Output Ripple = 53.755 mV.

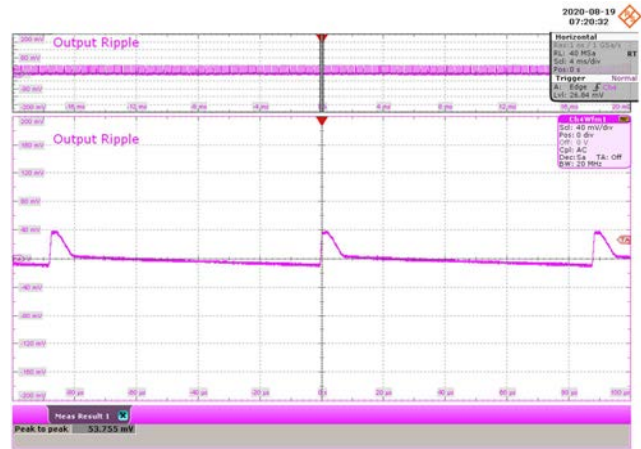

Figure 128 – 115 VAC 60 Hz.
 CH4: V_{OUT} , 40 mV / div., 4 ms / div.
 Zoom: 20 μ s / div.
 Output Ripple = 53.755 mV.

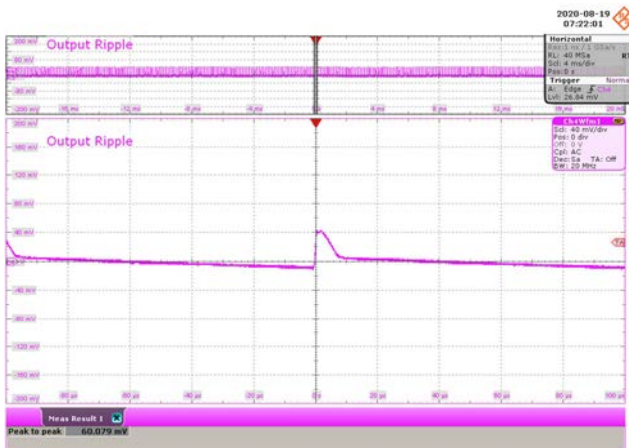

Figure 129 – 230 VAC 50 Hz.
 CH4: V_{OUT} , 40 mV / div., 4 ms / div.
 Zoom: 20 μ s / div.
 Output Ripple = 60.079 mV.

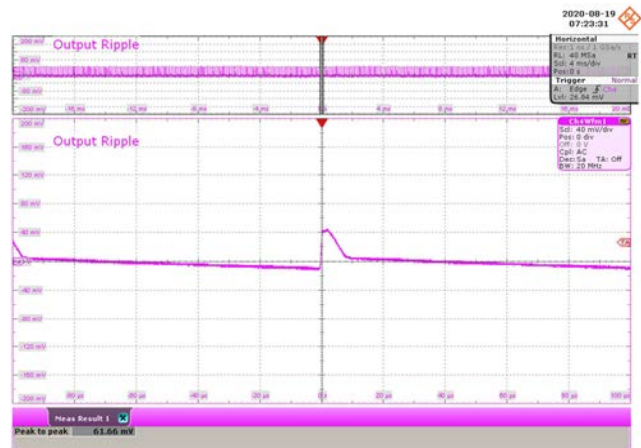

Figure 130 – 300 VAC 50 Hz.
 CH4: V_{OUT} , 40 mV / div., 4 ms / div.
 Zoom: 20 μ s / div.
 Output Ripple = 61.66 mV.

11.8.2.5 0% Load Condition

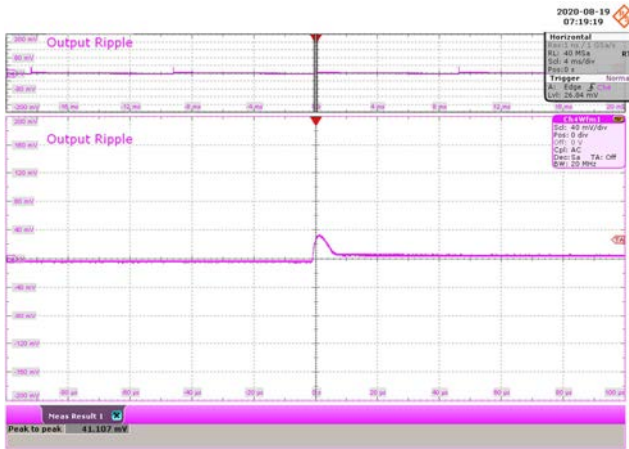

Figure 131 – 90 VAC 60 Hz.
 CH4: V_{OUT} , 40 mV / div., 4 ms / div.
 Zoom: 20 μ s / div.
 Output Ripple = 41.107 mV.

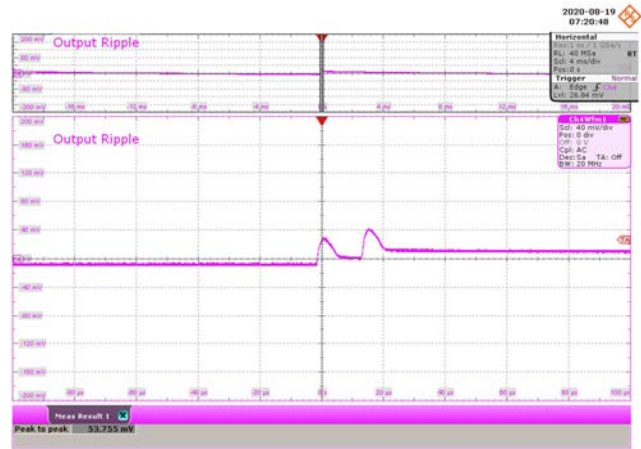

Figure 132 – 115 VAC 60 Hz.
 CH4: V_{OUT} , 40 mV / div., 4 ms / div.
 Zoom: 20 μ s / div.
 Output Ripple = 53.755 mV.

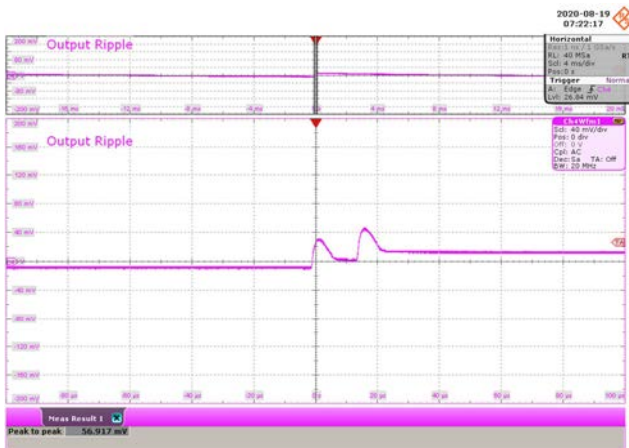

Figure 133 – 230 VAC 50 Hz.
 CH4: V_{OUT} , 40 mV / div., 4 ms / div.
 Zoom: 20 μ s / div.
 Output Ripple = 56.917 mV.

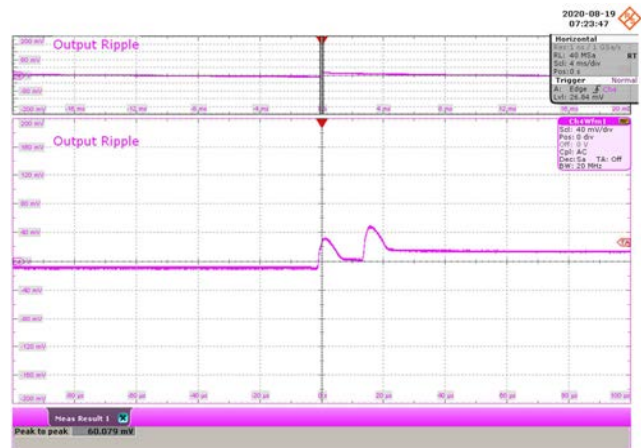

Figure 134 – 300 VAC 50 Hz.
 CH4: V_{OUT} , 40 mV / div., 4 ms / div.
 Zoom: 20 μ s / div.
 Output Ripple = 60.079 mV.

11.8.3 Output Ripple Voltage Graph from 0% - 100%

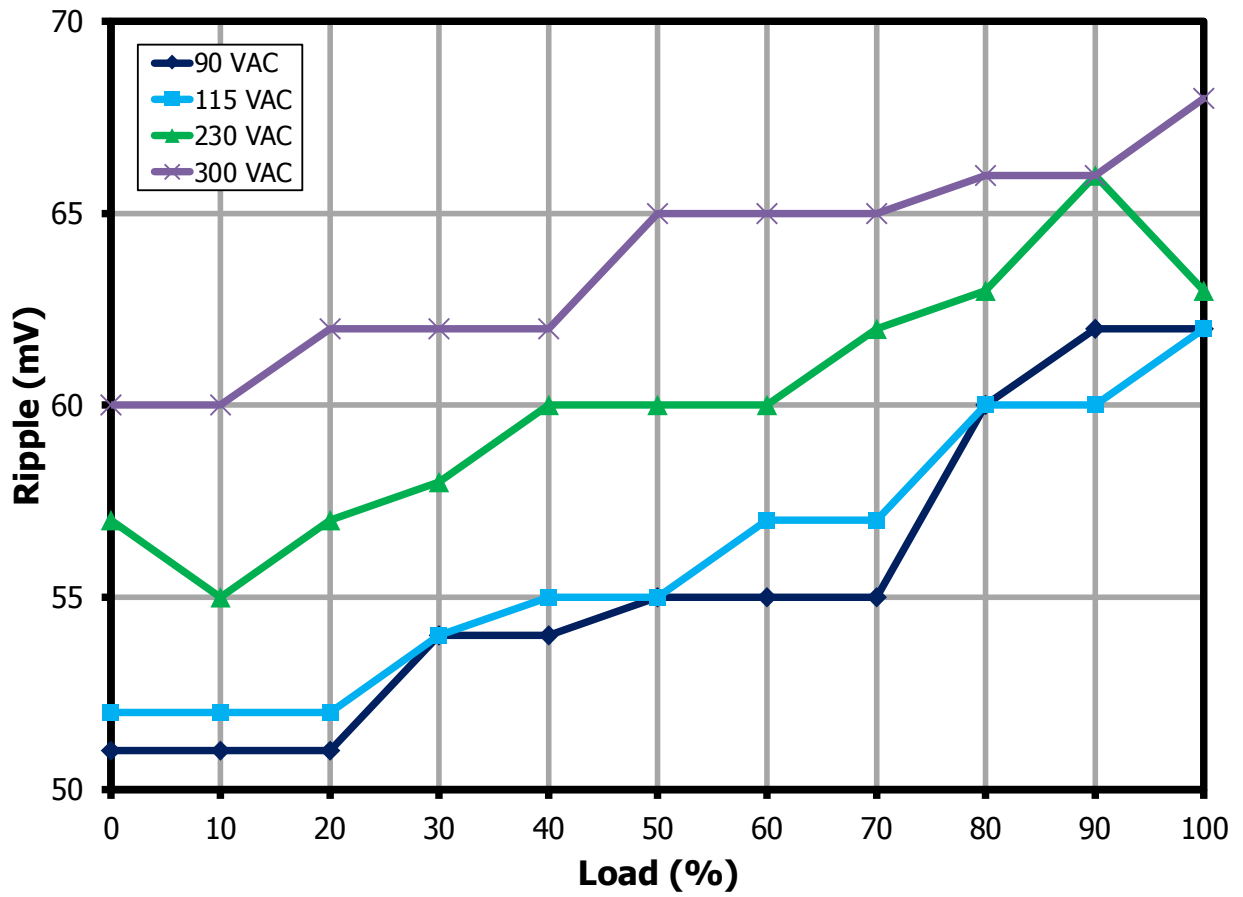

Figure 135 – Measured at the Board Output Terminals at Room Temperature.

12 Thermal Performance

12.1 *Test Set-Up*

Thermal evaluation was performed room temperature with the circuit board enclosed inside an acrylic box.

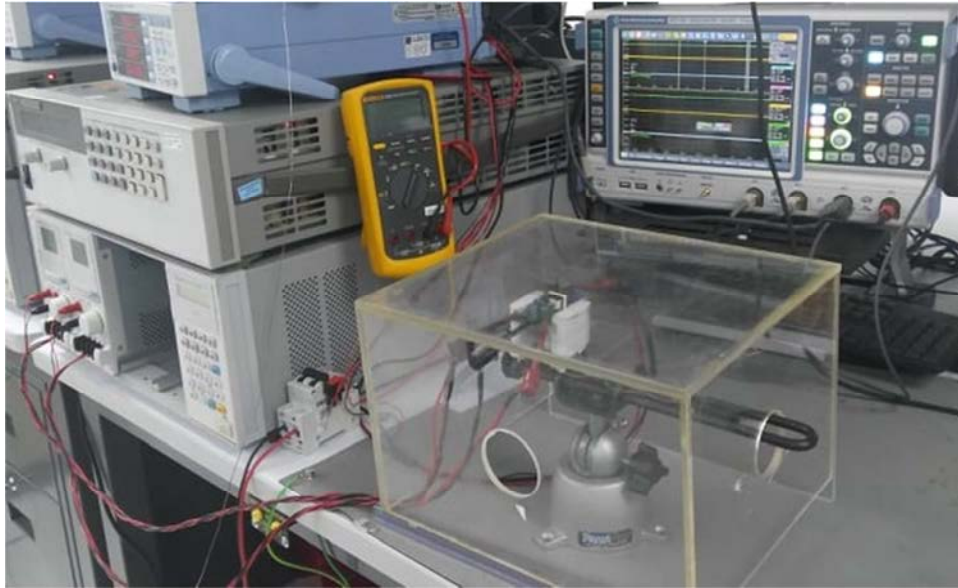

Figure 136 – Thermal Performance Set-up Using an Acrylic Box.

12.2 Thermal Performance at Room Temperature

12.2.1 90 VAC at Room Temperature

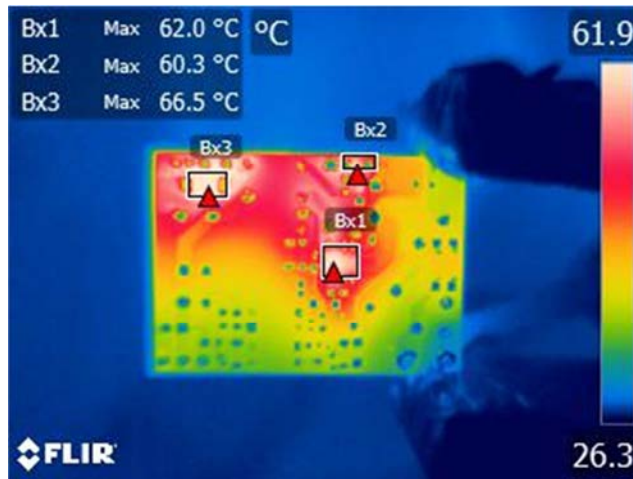

Figure 137 – Thermal Performance at 90 VAC, Bottom Side.

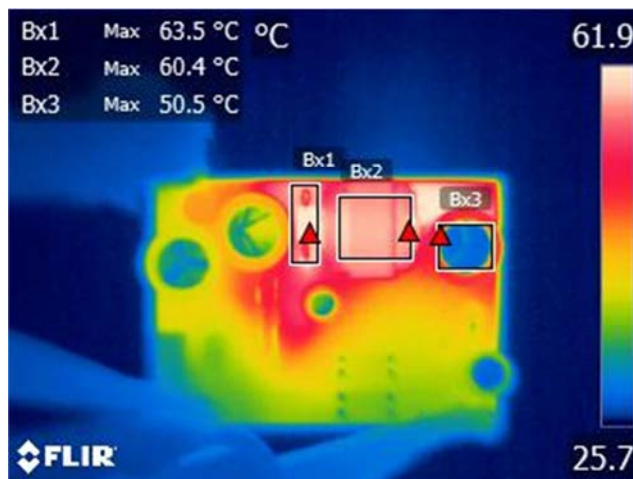

Figure 138 – Thermal Performance at 90 VAC, Top Side

Component	Temperature (°C)
LNK3306D (U1)	62.0
Snubber Resistor (R2)	60.3
Output Diode (D1)	66.5
Snubber Diode (D2)	63.5
Transformer (T1)	60.4
Output Capacitor (C5)	50.5
Ambient	25.0

12.2.2 115 VAC at Room Temperature

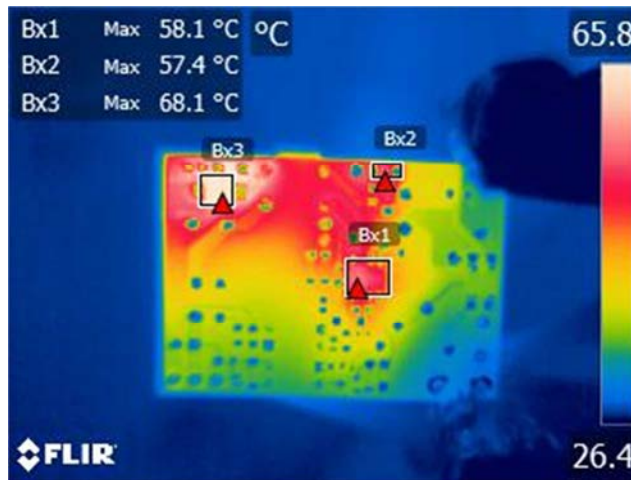

Figure 139 – Thermal Performance at 90 VAC, Bottom Side.

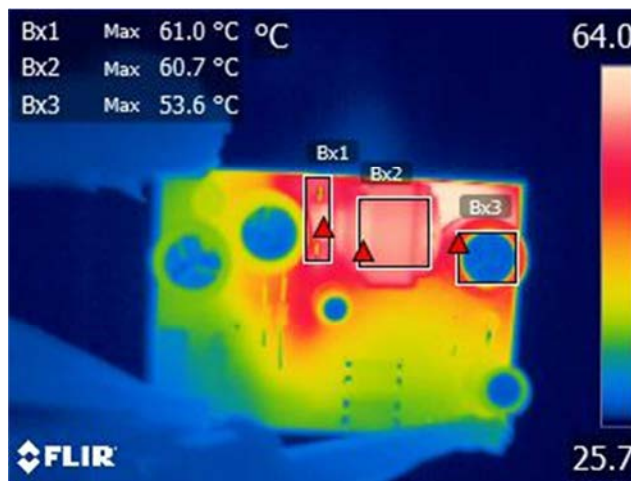

Figure 140 – Thermal Performance at 115 VAC, Top Side.

Component	Temperature (°C)
LNK3306D (U1)	58.1
Snubber Resistor (R2)	57.4
Output Diode (D1)	68.1
Snubber Diode (D2)	61.0
Transformer (T1)	60.7
Output Capacitor (C5)	53.6
Ambient	25.0

12.2.3 230 VAC at Room Temperature

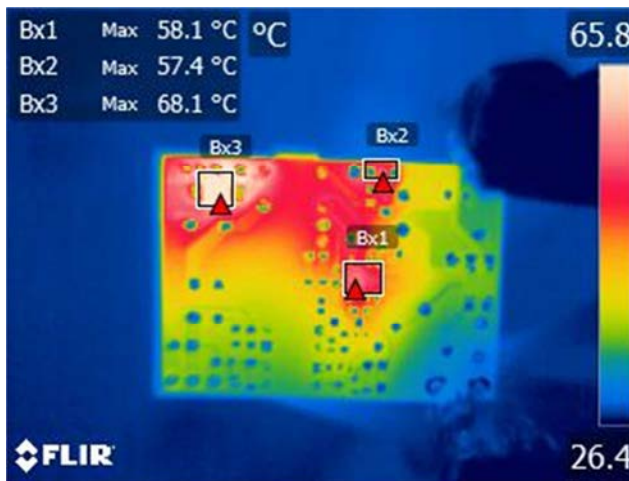

Figure 141 – Thermal Performance at 230 VAC, Bottom Side.

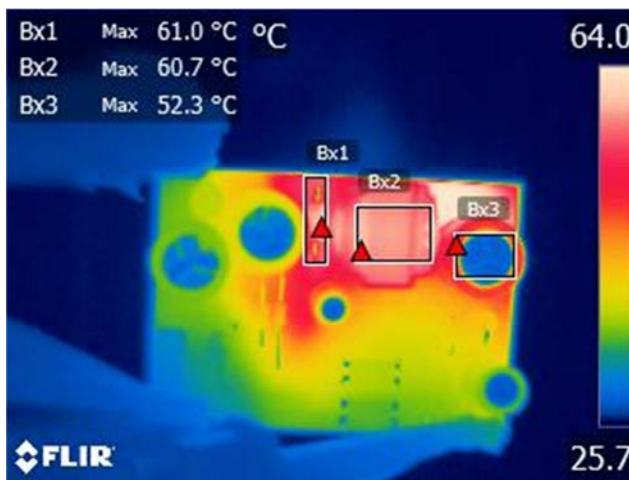

Figure 142 – Thermal Performance at 230 VAC, Top Side.

Component	Temperature (°C)
LNK3306D (U1)	58.1
Snubber Resistor (R2)	57.4
Output Diode (D1)	68.1
Snubber Diode (D2)	61.0
Transformer (T1)	60.7
Output Capacitor (C5)	52.3
Ambient	25.0

12.2.4 300 VAC at Room Temperature

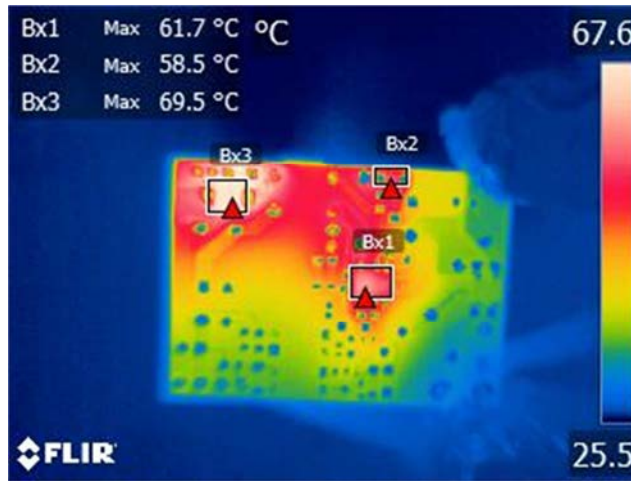

Figure 143 – Thermal Performance at 300 VAC, Bottom Side.

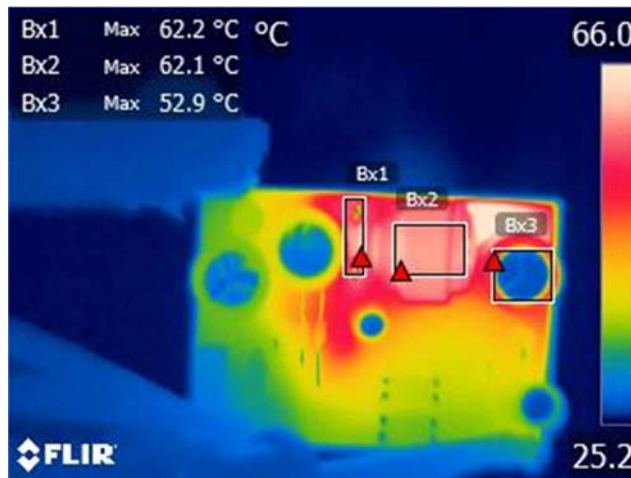

Figure 144 – Thermal Performance at 300 VAC, Top Side.

Component	Temperature (°C)
LNK3306D (U1)	61.7
Snubber Resistor (R2)	58.5
Output Diode (D1)	69.5
Snubber Diode (D2)	62.2
Transformer (T1)	62.1
Output Capacitor (C5)	52.9
Ambient	25.0

13 Conducted EMI

Conducted emissions tests were performed at 115 VAC and 230 VAC at full load (12 V, 1 A). Measurements were taken with an Artificial Hand connected and a floating DC output load resistor. A DC output cable was included.

13.1 Test Set-up Equipment

13.1.1 Equipment and Load Used

1. Rohde and Schwarz ENV216 two line V-network.
2. Rohde and Schwarz ESRP EMI test receiver.
3. Hioki 3322 power Hi-tester.
4. Chroma measurement test fixture.
5. Input voltage set at 115 VAC and 230 VAC.

13.2 Test Set-up

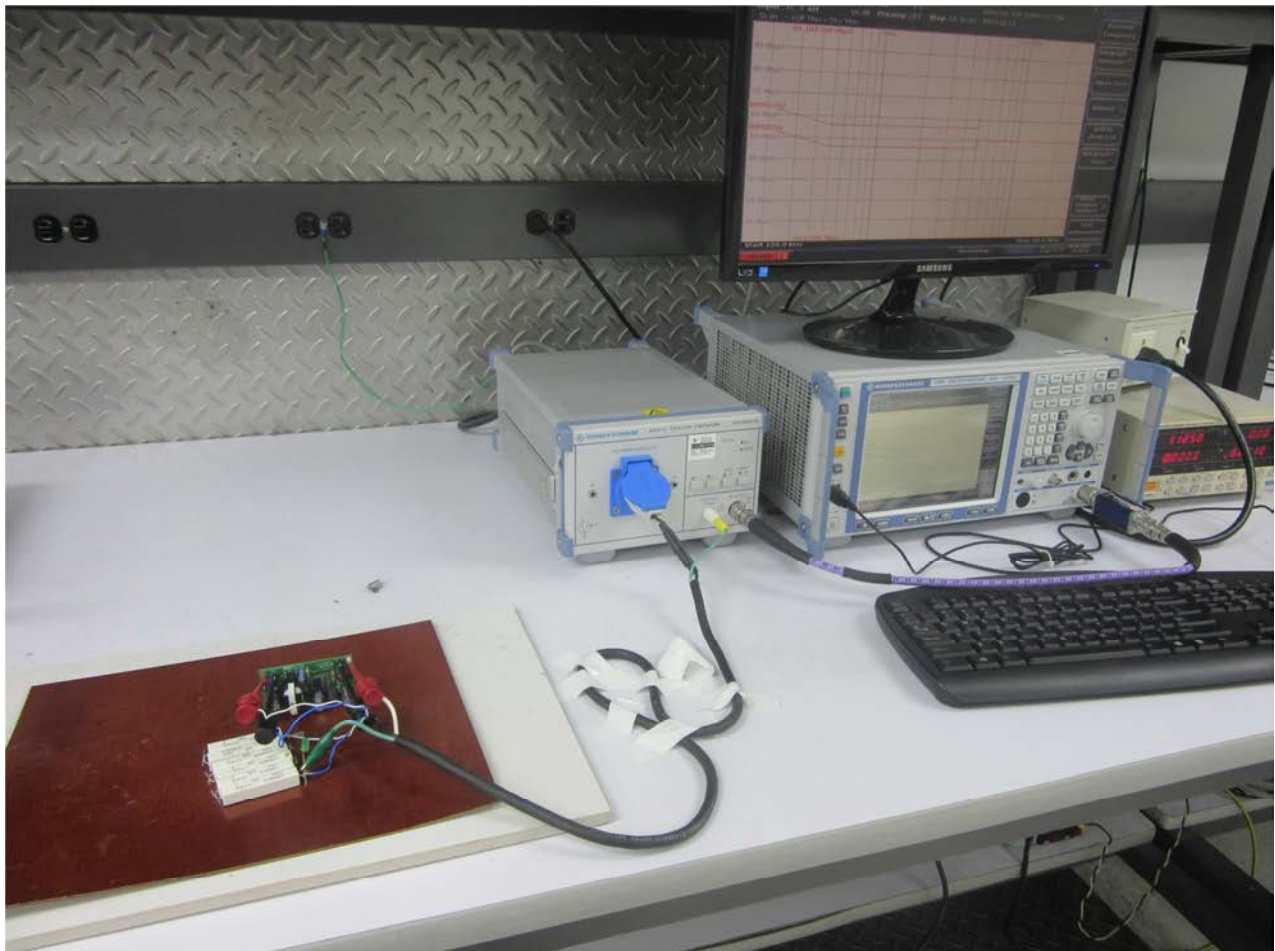

Figure 145 – EMI Test Set-up.

13.3 Test Results

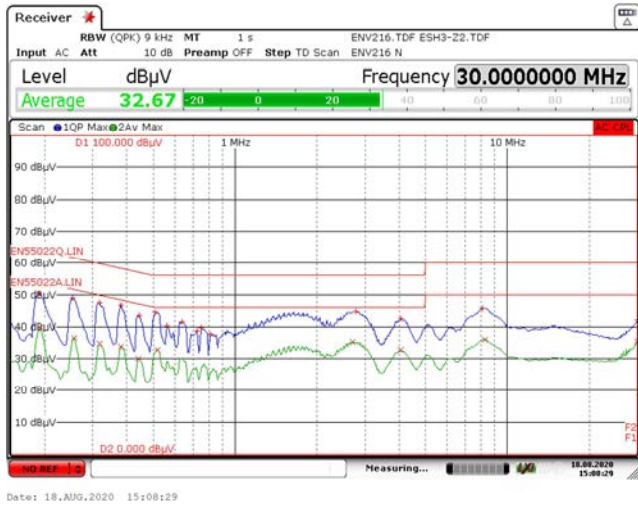

Figure 146 – 115 VAC 60 Hz, Artificial Hand.

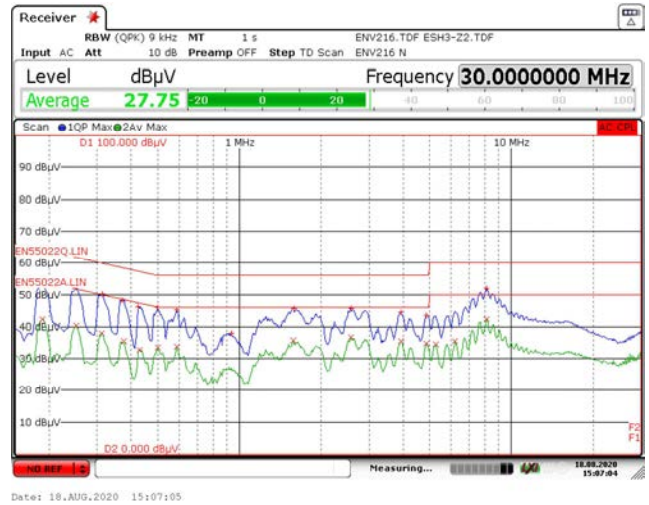

Figure 147 – 230 VAC 60 Hz, Artificial Hand.

14 Line Surge

Differential and common mode input line surge testing was completed on a single test unit to IEC61000-4-5. Input voltage was set at 230 VAC / 60 Hz. Output was loaded at full load and operation was verified following each surge event.

14.1 Surge

DM Surge Level (V)	Input Voltage (VAC)	Injection Location	Injection Phase (°)	Test Result (Pass/Fail)
+1000	230	L to N	0	Pass
-1000	230	L to N	0	Pass
+1000	230	L to N	90	Pass
-1000	230	L to N	90	Pass
+1000	230	L to N	180	Pass
-1000	230	L to N	180	Pass
+1000	230	L to N	270	Pass
-1000	230	L to N	270	Pass

Note: In all PASS results, no damage and no auto-restart was observed.

14.2 Ring Wave

Surge Level (V)	Input Voltage (VAC)	Injection Location	Injection Phase (°)	Test Result (Pass/Fail)
+2500	230	L to N	0	Pass
-2500	230	L to N	0	Pass
+2500	230	L to N	90	Pass
-2500	230	L to N	90	Pass
+2500	230	L to N	180	Pass
-2500	230	L to N	180	Pass
+2500	230	L to N	270	Pass
-2500	230	L to N	270	Pass

Note: In all PASS results, no damage and no auto-restart was observed.

15 Revision History

Date	Author	Revision	Description and Changes	Reviewed
18-Feb-21	JPB/DS	1.0	Initial Release.	Apps & Mktg
26-May-21	KM	1.1	Added Transformer Supplier for T1.	Apps & Mktg
25-Jul-21	KM	1.2	Minor Formatting Change.	Mktg



For the latest updates, visit our website: www.power.com

Reference Designs are technical proposals concerning how to use Power Integrations' gate drivers in particular applications and/or with certain power modules. These proposals are "as is" and are not subject to any qualification process. The suitability, implementation and qualification are the sole responsibility of the end user. The statements, technical information and recommendations contained herein are believed to be accurate as of the date hereof. All parameters, numbers, values and other technical data included in the technical information were calculated and determined to our best knowledge in accordance with the relevant technical norms (if any). They may base on assumptions or operational conditions that do not necessarily apply in general. We exclude any representation or warranty, express or implied, in relation to the accuracy or completeness of the statements, technical information and recommendations contained herein. No responsibility is accepted for the accuracy or sufficiency of any of the statements, technical information, recommendations or opinions communicated and any liability for any direct, indirect or consequential loss or damage suffered by any person arising therefrom is expressly disclaimed.

Power Integrations reserves the right to make changes to its products at any time to improve reliability or manufacturability. Power Integrations does not assume any liability arising from the use of any device or circuit described herein. POWER INTEGRATIONS MAKES NO WARRANTY HEREIN AND SPECIFICALLY DISCLAIMS ALL WARRANTIES INCLUDING, WITHOUT LIMITATION, THE IMPLIED WARRANTIES OF MERCHANTABILITY, FITNESS FOR A PARTICULAR PURPOSE, AND NON-INFRINGEMENT OF THIRD PARTY RIGHTS.

Patent Information

The products and applications illustrated herein (including transformer construction and circuits' external to the products) may be covered by one or more U.S. and foreign patents, or potentially by pending U.S. and foreign patent applications assigned to Power Integrations. A complete list of Power Integrations' patents may be found at www.power.com. Power Integrations grants its customers a license under certain patent rights as set forth at <http://www.power.com/ip.htm>.

Power Integrations, the Power Integrations logo, CAPZero, ChiPhy, CHY, DPA-Switch, EcoSmart, E-Shield, eSIP, eSOP, HiperPLC, HiperPFS, HiperTFS, InnoSwitch, Innovation in Power Conversion, InSOP, LinkSwitch, LinkZero, LYTSwitch, SENZero, TinySwitch, TOPSwitch, PI, PI Expert, SCALE, SCALE-1, SCALE-2, SCALE-3 and SCALE-iDriver, are trademarks of Power Integrations, Inc. Other trademarks are property of their respective companies. ©2019, Power Integrations, Inc.

Power Integrations Worldwide Sales Support Locations

WORLD HEADQUARTERS

5245 Hellyer Avenue
San Jose, CA 95138, USA.
Main: +1-408-414-9200
Customer Service:
Worldwide: +1-65-635-64480
Americas: +1-408-414-9621
e-mail: usasales@power.com

CHINA (SHANGHAI)

Rm 2410, Charity Plaza, No. 88,
North Caoxi Road,
Shanghai, PRC 200030
Phone: +86-21-6354-6323
e-mail: chinasales@power.com

CHINA (SHENZHEN)

17/F, Hivac Building, No. 2, Keji
Nan 8th Road, Nanshan District,
Shenzhen, China, 518057
Phone: +86-755-8672-8689
e-mail: chinasales@power.com

GERMANY (AC-DC/LED Sales)

Einsteinring 24
85609 Dornach/Aschheim
Germany
Tel: +49-89-5527-39100
e-mail: eurosales@power.com

GERMANY (Gate Driver Sales)

HellwegForum 1
59469 Ense
Germany
Tel: +49-2938-64-39990
e-mail: igbt-driver.sales@power.com

INDIA

#1, 14th Main Road
Vasanthanagar
Bangalore-560052
India
Phone: +91-80-4113-8020
e-mail: indiasales@power.com

ITALY

Via Milanese 20, 3rd. Fl.
20099 Sesto San Giovanni (MI) Italy
Phone: +39-024-550-8701
e-mail: eurosales@power.com

JAPAN

Yusen Shin-Yokohama 1-chome Bldg.
1-7-9, Shin-Yokohama, Kohoku-ku
Yokohama-shi,
Kanagawa 222-0033 Japan
Phone: +81-45-471-1021
e-mail: japansales@power.com

KOREA

RM 602, 6FL
Korea City Air Terminal B/D,
159-6
Samsung-Dong, Kangnam-Gu,
Seoul, 135-728 Korea
Phone: +82-2-2016-6610
e-mail: koreasales@power.com

SINGAPORE

51 Newton Road,
#19-01/05 Goldhill Plaza
Singapore, 308900
Phone: +65-6358-2160
e-mail: singaporesales@power.com

TAIWAN

5F, No. 318, Nei Hu Rd.,
Sec. 1
Nei Hu District
Taipei 11493, Taiwan R.O.C.
Phone: +886-2-2659-4570
e-mail: taiwansales@power.com

UK

Building 5, Suite 21
The Westbrook Centre
Milton Road
Cambridge
CB4 1YG
Phone: +44 (0) 7823-557484
e-mail: eurosales@power.com



Power Integrations, Inc.

Tel: +1 408 414 9200 Fax: +1 408 414 9201
www.power.com