

S.210 | S - 1/2" drive extensions





Standards:

NF ISO 3316, ISO 3316, DIN 3123, ASME B107.10

Description:

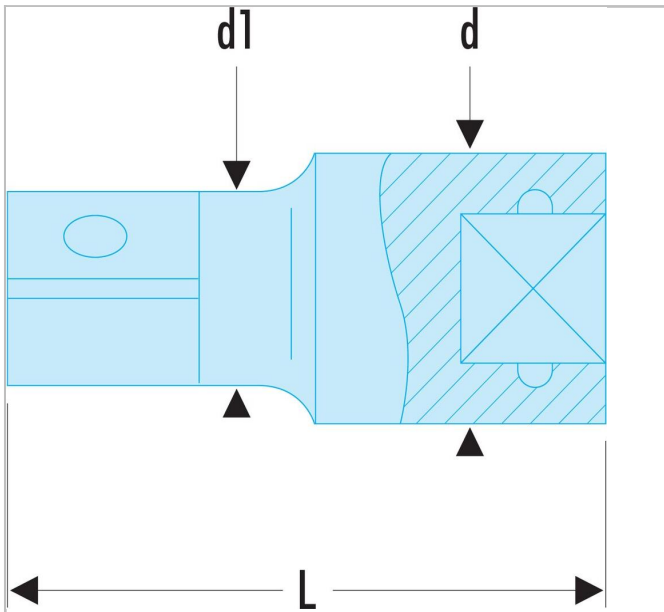
- Finish: bright chrome.



	S.210
Diameter [mm]	23.0
Diameter D1 [mm]	16.5
Length L [mm]	130.0
Square [in]	1/2
Weight [g]	225.0