

S.217 | S - 1/2" drive extensions



Standards:
NF ISO 3316, ISO 3316, DIN
3123, ASME B107.10

Description:

- Finish: bright chrome.

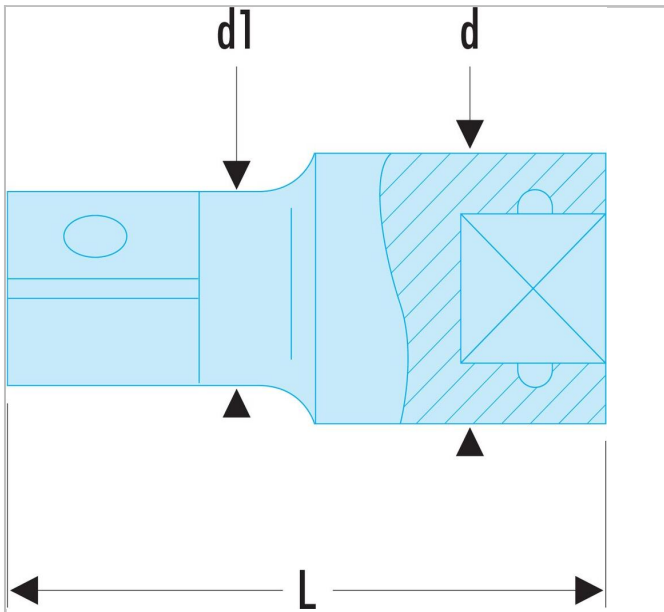

	S.217
Diameter [mm]	23.0
Diameter D1 [mm]	16.5
Length L [mm]	500.0
Square [in]	1/2
Weight [g]	840.0